

TR-M2M-0001v3.1.1

ユースケース集

Use Cases Collection

2019年06月28日制定

一般社団法人

情報通信技術委員会

THE TELECOMMUNICATION TECHNOLOGY COMMITTEE

本書は、一般社団法人情報通信技術委員会が著作権を保有しています。  
内容の一部又は全部を一般社団法人情報通信技術委員会の許諾を得ることなく複製、  
転載、改変、転用及びネットワーク上での送信、配布を行うことを禁止します。

<参考> [Remarks]

1. 国際勧告等の関連 [Relationship with international recommendations and standards]

本技術レポートは、oneM2M で作成された Technical Report 0001 (Version 3.1.1) に準拠している。

[This Technical Report is transposed based on the Technical Report 0001 (Version 3.1.1) developed by oneM2M.]

2. 作成専門委員会 [Working Group]

oneM2M 専門委員会 [oneM2M Working Group]



## ONEM2M TECHNICAL REPORT

Document Number	TR-0001-V3.1.1
Document Name:	Use Cases Collection
Date:	2019-05-13
Abstract:	This oneM2M Technical Report includes a collection of use cases from various M2M industry segments. Use cases focus on the sequence of interactions among actors, and may include potential requirements.

Template Version: January 2017 (Do not modify)

The present document is provided for future development work within oneM2M only. The Partners accept no liability for any use of this report.

The present document has not been subject to any approval process by the oneM2M Partners Type 1. Published oneM2M specifications and reports for implementation should be obtained via the oneM2M Partners' Publications Offices.

## About oneM2M

The purpose and goal of oneM2M is to develop technical specifications which address the need for a common M2M Service Layer that can be readily embedded within various hardware and software, and relied upon to connect the myriad of devices in the field with M2M application servers worldwide.

More information about oneM2M may be found at: <http://www.oneM2M.org>

## Copyright Notification

© 2019, oneM2M Partners Type 1 (ARIB, ATIS, CCSA, ETSI, TIA, TSDSI, TTA, TTC).

All rights reserved.

The copyright and the foregoing restriction extend to reproduction in all media.

## Notice of Disclaimer & Limitation of Liability

The information provided in this document is directed solely to professionals who have the appropriate degree of experience to understand and interpret its contents in accordance with generally accepted engineering or other professional standards and applicable regulations. No recommendation as to products or vendors is made or should be implied.

NO REPRESENTATION OR WARRANTY IS MADE THAT THE INFORMATION IS TECHNICALLY ACCURATE OR SUFFICIENT OR CONFORMS TO ANY STATUTE, GOVERNMENTAL RULE OR REGULATION, AND FURTHER, NO REPRESENTATION OR WARRANTY IS MADE OF MERCHANTABILITY OR FITNESS FOR ANY PARTICULAR PURPOSE OR AGAINST INFRINGEMENT OF INTELLECTUAL PROPERTY RIGHTS. NO oneM2M PARTNER TYPE 1 SHALL BE LIABLE, BEYOND THE AMOUNT OF ANY SUM RECEIVED IN PAYMENT BY THAT PARTNER FOR THIS DOCUMENT, WITH RESPECT TO ANY CLAIM, AND IN NO EVENT SHALL oneM2M BE LIABLE FOR LOST PROFITS OR OTHER INCIDENTAL OR CONSEQUENTIAL DAMAGES. oneM2M EXPRESSLY ADVISES ANY AND ALL USE OF OR RELIANCE UPON THIS INFORMATION PROVIDED IN THIS DOCUMENT IS AT THE RISK OF THE USER.

# Contents

Contents.....	3
1 Scope.....	12
2 References.....	12
2.1 Normative references.....	12
2.2 Informative references.....	12
3 Abbreviations.....	13
4 Conventions.....	15
5 Energy Use Cases.....	15
5.1 Wide area, energy related measurement/control system for advanced transmission and distribution automation.....	15
5.1.1 Description.....	15
5.1.2 Source.....	16
5.1.3 Actors.....	16
5.1.4 Pre-conditions.....	16
5.1.5 Triggers.....	16
5.1.6 Normal Flow.....	16
5.1.7 Alternative Flow.....	18
5.1.8 Post-conditions.....	18
5.1.9 High Level Illustration.....	18
5.1.10 Potential Requirements.....	18
5.2 Analytics for M2M.....	19
5.2.1 Description.....	19
5.2.2 Source.....	21
5.2.3 Actors.....	21
5.2.4 Pre-conditions.....	21
5.2.5 Triggers.....	21
5.2.6 Normal Flow.....	21
5.2.7 Alternative Flow 1.....	21
5.2.8 Post-conditions.....	22
5.2.9 High Level Illustration.....	22
5.2.10 Potential requirements.....	24
5.3 Smart Meter Reading.....	24
5.3.1 Description.....	24
5.3.2 Source.....	24
5.3.3 Actors.....	24
5.3.4 Pre-conditions.....	24
5.3.5 Triggers.....	24
5.3.6 Normal Flow.....	24
5.3.7 Alternative Flow.....	27
5.3.8 Post-conditions.....	27
5.3.9 High Level Illustration.....	27
5.3.10 Potential Requirements.....	27
5.4 Environmental Monitoring of Remote Locations to Determine Hydropower.....	28
5.4.1 Description.....	28
5.4.2 Source.....	28
5.4.3 Actors.....	28
5.4.4 Pre-conditions.....	28
5.4.5 Triggers.....	29
5.4.6 Normal Flow.....	29
5.4.7 Alternative Flow.....	29
5.4.8 Post-conditions.....	30
5.4.9 High Level Illustration.....	30
5.4.10 Potential Requirements.....	30
5.5 Oil and Gas Pipeline Cellular/Satellite Gateway.....	30

5.5.1	Description .....	30
5.5.2	Source.....	30
5.5.3	Actors .....	31
5.5.4	Pre-conditions .....	31
5.5.5	Triggers .....	31
5.5.6	Normal Flow .....	31
5.5.7	Alternative Flow.....	32
5.5.8	Post-conditions.....	33
5.5.9	High Level Illustration .....	34
5.5.10	Potential Requirements .....	34
6	Enterprise Use Cases .....	36
6.1	Smart Building.....	36
6.1.1	Description .....	36
6.1.2	Source.....	36
6.1.3	Actors .....	36
6.1.4	Pre-conditions .....	37
6.1.5	Triggers .....	37
6.1.6	Normal Flow .....	37
6.1.7	Alternative Flow.....	38
6.1.8	Post-conditions.....	38
6.1.9	High Level Illustration .....	38
6.1.10	Potential Requirements .....	38
6.2	Machine socialization .....	39
6.2.1	Description .....	39
6.2.2	Source.....	39
6.2.3	Actors .....	39
6.2.4	Pre-conditions .....	39
6.2.5	Triggers .....	39
6.2.6	Normal Flow .....	39
6.2.7	Alternative Flow.....	39
6.2.8	Post-conditions.....	40
6.2.9	High Level Illustration .....	40
<b>6.2.10</b>	Potential Requirements .....	40
7	Healthcare Use Cases .....	40
7.1	M2M Healthcare Gateway.....	40
7.1.1	Description .....	40
7.1.2	Source.....	41
7.1.3	Actors .....	41
7.1.4	Pre-conditions .....	41
7.1.5	Triggers .....	41
7.1.6	Normal Flow .....	42
7.1.7	Alternative Flow.....	43
7.1.8	Post-conditions.....	47
7.1.9	High Level Illustration .....	47
7.1.10	Potential Requirements .....	48
7.2	Wellness Services .....	50
7.2.1	Description .....	50
7.2.2	Source.....	50
7.2.3	Actors .....	50
7.2.4	Pre-conditions .....	51
7.2.5	Triggers .....	51
7.2.6	Normal Flow .....	51
7.2.7	Alternative Flow.....	51
7.2.8	Post-conditions.....	52
7.2.9	High Level Illustration .....	52
7.2.10	Potential Requirements .....	52
7.3	Secure remote patient care and monitoring.....	53
7.3.1	Description .....	53
7.3.2	Source.....	55
7.3.3	Actors .....	55

7.3.4	Pre-conditions .....	55
7.3.5	Triggers .....	55
7.3.6	Normal Flow .....	55
7.3.7	Alternative Flow.....	56
7.3.8	Post-conditions.....	57
7.3.9	High Level Illustration .....	57
7.3.10	Potential requirements.....	57
7.4	Use case for information correlation.....	58
7.4.1	Description .....	58
7.4.2	Source.....	58
7.4.3	Actors .....	58
7.4.4	Pre-conditions .....	59
7.4.5	Triggers .....	59
7.4.6	Normal Flow .....	59
7.4.7	Alternative flow .....	60
7.4.8	Post-conditions.....	60
7.4.9	High Level Illustration .....	60
7.4.10	Potential requirements.....	60
8	Public Services Use Cases.....	60
8.1	Street Light Automation .....	60
8.1.1	Description .....	60
8.1.2	Source.....	61
8.1.3	Actors .....	61
8.1.4	Pre-conditions .....	61
8.1.5	Triggers .....	61
8.1.6	Normal Flow .....	61
8.1.7	Alternative Flow.....	64
8.1.8	Post-conditions.....	64
8.1.9	High Level Illustration .....	65
8.1.10	Potential Requirements .....	65
8.2	Devices, Virtual Devices and Things.....	66
8.2.1	Description .....	66
8.2.2	Source.....	66
8.2.3	Actors .....	66
8.2.4	Pre-conditions .....	67
8.2.5	Triggers .....	67
8.2.6	Normal Flow .....	67
8.2.7	Alternative Flow.....	67
8.2.8	Post-conditions.....	67
8.2.9	High Level Illustration .....	67
8.2.10	Potential Requirements .....	67
8.3	Car/Bicycle Sharing Services .....	68
8.4	Smart Parking .....	68
8.5	Information Delivery service in the devastated area.....	68
8.5.1	Description .....	68
8.5.2	Source.....	68
8.5.3	Actors .....	68
8.5.4	Pre-conditions .....	69
8.5.5	Triggers .....	69
8.5.6	Normal Flow .....	69
8.5.7	Alternative Flow.....	70
8.5.8	Post-conditions.....	70
8.5.9	High Level Illustration .....	71
8.5.10	Potential Requirements .....	71
8.6	Holistic Service Provider .....	72
8.6.1	Description .....	72
8.6.2	Source.....	72
8.6.3	Actors .....	72
8.6.4	Pre-conditions .....	73
8.6.5	Triggers .....	73
8.6.6	Normal Flow .....	73



8.6.7	Alternative flow .....	74
8.6.8	Post-conditions .....	74
8.6.9	High Level Illustration .....	74
8.6.10	Potential requirements .....	74
9	Residential Use Cases .....	75
9.1	Home Energy Management .....	75
9.1.1	Description .....	75
9.1.2	Source.....	75
9.1.3	Actors .....	75
9.1.4	Pre-conditions .....	75
9.1.5	Triggers .....	76
9.1.6	Normal Flow .....	76
9.1.7	Alternative Flow.....	76
9.1.8	Post-conditions .....	76
9.1.9	High Level Illustration .....	77
9.1.10	Potential Requirements .....	77
9.2	Home Energy Management System (HEMS) .....	78
9.2.1	Description .....	78
9.2.2	Source.....	78
9.2.3	Actors .....	78
9.2.4	Pre-conditions .....	78
9.2.5	Triggers .....	78
9.2.6	Normal Flow .....	78
9.2.7	Alternative Flow.....	79
9.2.8	Post-conditions .....	79
9.2.9	High Level Illustration .....	79
9.2.10	Potential Requirements .....	79
9.3	Plug-In Electrical Charging Vehicles and power feed in home scenario .....	79
9.3.1	Description .....	79
9.3.2	Source.....	80
9.3.3	Actors .....	80
9.3.4	Pre-conditions .....	80
9.3.5	Triggers .....	80
9.3.6	Normal Flow .....	81
9.3.7	Alternative Flow.....	81
9.3.8	Post-conditions .....	81
9.3.9	High Level Illustration .....	82
9.3.10	Potential Requirements .....	82
9.4	Real-time Audio/Video Communication .....	83
9.4.1	Description .....	83
9.4.2	Source.....	83
9.4.3	Actors .....	83
9.4.4	Pre-conditions .....	84
9.4.5	Triggers .....	84
9.4.6	Normal Flow .....	84
9.4.7	Alternative Flow.....	84
9.4.8	Post-conditions .....	84
9.4.9	High Level Illustration .....	84
9.4.10	Potential Requirements .....	84
9.5	Event Triggered Task Execution .....	85
9.5.1	Description .....	85
9.5.2	Source.....	85
9.5.3	Actors .....	85
9.5.4	Pre-conditions .....	85
9.5.5	Triggers .....	85
9.5.6	Normal Flow .....	85
9.5.7	Alternative Flow.....	85
9.5.8	Post-conditions .....	86
9.5.9	High Level Illustration .....	86
9.5.10	Potential Requirements .....	86
9.6	Semantic Home Control.....	87

9.6.1	Description .....	87
9.6.2	Source.....	87
9.6.3	Actors .....	87
9.6.4	Pre-conditions .....	87
9.6.5	Triggers .....	87
9.6.6	Normal Flow .....	87
9.6.7	Alternative Flow.....	88
9.6.8	Post-conditions.....	88
9.6.9	High Level Illustration .....	88
9.6.10	Potential Requirements .....	88
9.7	Semantic Device Plug and Play .....	88
9.7.1	Description .....	88
9.7.2	Source.....	88
9.7.3	Actors .....	88
9.7.4	Pre-conditions .....	89
9.7.5	Triggers .....	89
9.7.6	Normal Flow .....	89
9.7.7	Alternative Flow.....	89
9.7.8	Post-conditions.....	89
9.7.9	High Level Illustration .....	89
9.7.10	Potential Requirements .....	89
9.8	Triggering in the Field Domain .....	89
10	Retail Use Cases .....	90
10.1	Vending Machines .....	90
10.1.1	Description .....	90
10.1.2	Source.....	90
10.1.3	Actors .....	90
10.1.4	Pre-conditions .....	90
10.1.5	Triggers .....	90
10.1.6	Normal Flow .....	90
10.1.7	Alternative Flow.....	90
10.1.8	Post-conditions.....	90
10.1.9	High Level Illustration .....	91
10.1.10	Potential Requirements .....	91
11	Transportation Use Cases.....	91
11.1	Vehicle Diagnostic & Maintenance Report .....	91
11.2	Remote Maintenance Services.....	91
11.3	Traffic Accident Information Collection .....	91
11.4	Fleet Management Service using DTG (Digital Tachograph) .....	91
11.5	Electronic Toll Collection (ETC) Service.....	92
11.6	Taxi Advertisement service .....	92
11.7	Vehicle Data Service .....	92
11.8	Smart Automatic Driving.....	92
11.9	Vehicle Data Wipe Service.....	92
12	Other Use Cases .....	93
12.1	Extending the M2M Access Network using Satellites.....	93
12.1.1	Description .....	93
12.1.2	Source.....	93
12.1.3	Actors .....	93
12.1.4	Pre-conditions .....	93
12.1.5	Triggers .....	93
12.1.6	Normal Flow .....	94
12.1.7	Alternative Flow.....	94
12.1.8	Post-conditions.....	94
12.1.9	High Level Illustration .....	94
12.1.10	Potential Requirements .....	94
12.2	M2M Data Traffic Management by the Underlying Network Operator .....	95
12.2.1	Description .....	95
12.2.2	Source.....	95
12.2.3	Actors .....	95

12.2.4	Pre-conditions .....	95
12.2.5	Triggers .....	95
12.2.6	Normal Flow .....	95
12.2.7	Alternative Flow.....	97
12.2.8	Post-conditions.....	97
12.2.9	High Level Illustration .....	97
12.2.10	Potential Requirements .....	98
12.3	Optimized M2M interworking with mobile networks (Optimizing connectivity management parameters) ..	98
12.3.1	Description .....	98
12.3.2	Source.....	99
12.3.3	Actors .....	99
12.3.4	Pre-conditions .....	99
12.3.5	Triggers .....	99
12.3.6	Normal Flow .....	99
12.3.7	Alternative Flow.....	100
12.3.8	Post-conditions.....	100
12.3.9	High Level Illustration .....	101
12.3.10	Potential Requirements .....	101
12.4	Optimized M2M interworking with mobile networks (Optimizing mobility management parameters) .....	101
12.4.1	Description .....	101
12.4.2	Source.....	102
12.4.3	Actors .....	102
12.4.4	Pre-conditions .....	103
12.4.5	Triggers .....	103
12.4.6	Normal Flow .....	103
12.4.7	Alternative Flow.....	104
12.4.8	Post-conditions.....	104
12.4.9	High Level Illustration .....	104
12.4.10	Potential Requirements .....	104
12.5	Sleepy Nodes .....	105
12.5.1	Description .....	105
12.5.2	Source.....	105
12.5.3	Actors .....	105
12.5.4	Pre-conditions .....	106
12.5.5	Triggers .....	106
12.5.6	Normal Flow .....	106
12.5.7	Alternative Flow.....	107
12.5.8	Post-conditions.....	107
12.5.9	High Level Illustration .....	107
12.5.10	Potential Requirements .....	107
12.6	Collection of M2M System data .....	110
12.6.1	Description .....	110
12.6.2	Source.....	110
12.6.3	Actors .....	110
12.6.4	Pre-conditions .....	110
12.6.5	Triggers .....	110
12.6.6	Normal Flow .....	110
12.6.7	Alternative Flow.....	110
12.6.8	Post-conditions.....	110
12.6.9	High Level Illustration .....	111
12.6.10	Potential Requirements .....	112
12.7	Leveraging Broadcasting/ Multicasting Capabilities of Underlying Networks .....	112
12.7.1	Description .....	112
12.7.2	Source.....	113
12.7.3	Actors .....	113
12.7.4	Pre-conditions .....	113
12.7.5	Triggers .....	113
12.7.6	Normal Flow .....	113
12.7.7	Alternative Flow.....	114
12.7.8	Post-conditions.....	114
12.7.9	High Level Illustration .....	114
12.7.10	Potential Requirements .....	115

12.8	Leveraging Service Provisioning for Equipment with Built-in M2M Device .....	115
12.8.1	Description .....	115
12.8.2	Source.....	116
12.8.3	Actors .....	116
12.8.4	Pre-conditions .....	116
12.8.5	Triggers .....	117
12.8.6	Normal Flow .....	117
12.8.7	Alternative Flow.....	119
12.8.8	Post-conditions.....	119
12.8.9	High Level Illustration .....	120
	Service Model	120
	Entity Model	120
12.8.10	Potential requirements.....	120
12.9	Semantics query for device discovery across M2M Service Providers .....	121
12.9.1	Description .....	121
12.9.2	Source.....	121
12.9.3	Actors .....	121
12.9.4	Pre-conditions .....	121
12.9.5	Triggers .....	122
12.9.6	Normal Flow .....	122
12.9.7	Alternative Flow.....	122
12.9.8	Post-conditions.....	122
12.9.9	High Level Illustration .....	122
12.9.10	Potential Requirements .....	123
12.10	Underlying network service activation and deactivation .....	123
12.10.1	Description .....	123
12.10.2	Source.....	124
12.10.3	Actors .....	124
12.10.4	Pre-conditions .....	124
12.10.5	Triggers .....	124
12.10.6	Normal Flow .....	124
12.10.7	Alternative Flow.....	125
12.10.8	Post-conditions.....	125
12.10.9	High Level Illustration .....	125
12.10.10	Potential requirements.....	125
12.11	On-demand data collection for factories.....	126
12.12	Smart Irrigation System .....	126
12.12.1	Description .....	126
12.12.2	Source.....	126
12.12.3	Actors .....	126
12.12.4	Pre-conditions .....	126
12.12.5	Triggers .....	127
12.12.6	Normal Flow .....	127
12.12.7	Alternative flow .....	127
12.12.8	Post-conditions.....	127
12.12.9	High Level Illustration .....	127
12.12.10	Potential requirements.....	128
12.13	Group Registration Management .....	128
12.13.1	Description .....	128
12.13.2	Source.....	128
12.13.3	Actors .....	128
12.13.4	Pre-conditions .....	128
12.13.5	Triggers .....	128
12.13.6	Normal Flow .....	128
12.13.7	Alternative flow .....	130
12.13.8	Post-conditions.....	130
12.13.9	High Level Illustration .....	130
12.13.10	Potential requirements.....	130
12.14	Multicast using group .....	130
12.14.1	Description .....	130
12.14.2	Source.....	130
12.14.3	Actors .....	130

12.14.4	Pre-conditions .....	130
12.14.5	Triggers .....	130
12.14.6	Normal Flow .....	130
12.14.7	Alternative flow .....	131
12.14.8	Post-conditions.....	131
12.14.9	High Level Illustration .....	131
12.14.10	Potential requirements.....	131
12.15	Access control using group.....	131
12.15.1	Description .....	131
12.15.2	Source.....	131
12.15.3	Actors .....	132
12.15.4	Pre-conditions .....	132
12.15.5	Triggers .....	132
12.15.6	Normal Flow .....	132
12.15.7	Alternative flow .....	132
12.15.8	Post-conditions.....	133
12.15.9	High Level Illustration .....	133
12.15.10	Potential requirements.....	133
12.16	Personal data management mechanism based on user's privacy preference .....	133
12.16.1	Description .....	133
12.16.2	Source.....	133
12.16.3	Actors .....	133
12.16.4	Pre-conditions .....	134
12.16.5	Triggers .....	134
12.16.6	Normal Flow .....	134
12.16.7	Alternative flow .....	135
12.16.8	Post-conditions.....	135
12.16.9	High Level Illustration .....	135
12.16.10	Potential requirements.....	135
12.17	Quality of Sensor Data.....	136
12.17.1	Description .....	136
12.17.2	Source.....	136
12.17.3	Actors .....	136
12.17.4	Pre-conditions .....	137
12.17.5	Triggers .....	137
12.17.6	Normal Flow .....	137
12.17.7	Alternative flow .....	137
12.17.8	Post-conditions.....	137
12.17.9	High Level Illustration .....	137
12.17.10	Potential requirements.....	138
12.18	Agriculture monitoring drone system .....	138
12.18.1	Description .....	138
12.18.2	Source.....	139
12.18.3	Actors .....	139
12.18.4	Pre-conditions .....	139
12.18.5	Triggers .....	139
12.18.6	Normal Flow .....	139
12.18.7	Alternative Flow.....	139
12.18.8	Post-conditions.....	139
12.18.9	High Level Illustration .....	140
12.18.10	Potential requirements.....	140
12.19	Terms And Conditions Markup Language for Privacy Policy Manager .....	140
12.19.1	Description .....	140
12.19.2	Source.....	141
12.19.3	Actors .....	141
12.19.4	Pre-conditions .....	141
12.19.5	Triggers .....	141
12.19.6	Normal Flow .....	142
12.19.7	Alternative flow .....	142
12.19.8	Post-conditions.....	142
12.19.9	High Level Illustration .....	142
12.19.10	Potential requirements.....	143

12.20	Intelligent agricultural product traceability.....	143
12.20.1	Description.....	143
12.20.2	Source.....	143
12.20.3	Actors.....	143
12.20.4	Pre-conditions.....	144
12.20.5	Triggers.....	144
12.20.6	Normal Flow.....	144
12.20.7	Alternative flow.....	144
12.20.8	Post-conditions.....	144
12.20.9	High Level Illustration.....	144
12.20.10	Potential requirements.....	145
13	History.....	145

---

# 1 Scope

The present document includes a collection of use cases from a variety of M2M industry segments . Each use case may include a description, source, actors, pre-conditions, triggers, normal and alternative flow of sequence of interactions among actors and system, post-conditions, illustrations and potential requirements. The potential requirements provide an initial view of what oneM2M requirements could arise from the Use Case as seen by the contributor. These are intended to help the reader understand the use case's needs. These potential requirements may have been subsequently submitted by the contributor for consideration as candidate oneM2M requirements, which may or may not have been agreed as a oneM2M requirement (often after much editing). As such, there may not be a direct mapping from the potential requirements to agreed oneM2M requirements [i.14]

---

## 2 References

References are either specific (identified by date of publication and/or edition number or version number) or non-specific. For specific references, only the cited version applies. For non-specific references, the latest version of the referenced document (including any amendments) applies.

### 2.1 Normative references

The following referenced documents are necessary for the application of the present document.

Not applicable.

### 2.2 Informative references

*Clause 2.2 shall only contain informative references which are cited in the document itself.*

The following referenced documents are not necessary for the application of the present document but they assist the user with regard to a particular subject area.

- [i.1] oneM2M Drafting Rules ([http://member.onem2m.org/Static\\_pages/Others/Rules\\_Pages/oneM2M-Drafting-Rules-V1\\_0.doc](http://member.onem2m.org/Static_pages/Others/Rules_Pages/oneM2M-Drafting-Rules-V1_0.doc))
- [i.1] ETSI TR 102 935 v2.1.1, Machine to Machine communications (M2M);Applicability of M2M architecture to Smart Grid Networks; Impact of Smart Grids on M2M platform
- [i.2] ETSI TS 102 689 V1.1.1, Machine-to-Machine communications (M2M);M2M service requirements
- [i.3] ETSI TR 102 732, Machine to Machine Communications (M2M); Use cases of M2M applications for eHealth
- [i.4] ETSI TR 102 897, Machine to Machine Communications (M2M);Use cases of M2M applications for City Automation
- [i.5] HGI-GD017-R3, Use Cases and Architecture for a Home Energy Management Service
- [i.6] ISO/ IEC 15118 Road vehicles, vehicle to grid communication
- [i.7] Mandate 486, MANDATE FOR PROGRAMMING AND STANDARDISATION ADDRESSED TO THE EUROPEAN STANDARDISATION BODIES IN THE FIELD OF URBAN RAIL
- [i.8] DIN specification 70121, ELECTROMOBILITY - DIGITAL COMMUNICATION BETWEEN A D.C. EV CHARGING STATION AND AN ELECTRIC VEHICLE FOR CONTROL OF D.C. CHARGING IN THE COMBINED CHARGING SYSTEM
- [i.9] ETSI TR 102 638, Intelligent Transport Systems (ITS);Vehicular Communications; Basic Set of Applications; Definitions
- [i.10] 3GPP TS 22.368, Service requirements for Machine-Type Communications (MTC); Stage 2
- [i.11] 3GPP TS 23.682, Architecture enhancements to facilitate communications with packet data networks and applications
- [i.12] 3GPP TR 23.887, Architectural Enhancements for Machine Type and other mobile data applications
- [i.13] Communications Guidelines defined in Continua Health Alliance, The Continua Health Alliance, Version 2012 Design Guidelines
- [i.14] oneM2M TS-0002-Requirements Technical Specification

- [i.15] ETSI TS103.383 Smart Cards; Embedded UICC; Requirements Specification
- [i.16] IEC 61850 Communication networks and systems in substations
- [i.17] oneM2M TR-0013 Home Domain Enablement Technical Report
- [i.18] oneM2M TR-0018 Industrial Domain Enablement Technical Report
- [i.19] oneM2M TR-0016 Authorization Architecture and Access Control Policy
- [i.20] oneM2M TR-0026 Vehicular Domain Enablement Technical Report

---

## 3 Abbreviations

For the purposes of the present document, the following abbreviations apply:

A/C	Air Conditioner
ACL	Access Control List
AHD	Application Hosting Device
AL	Authorization Level
AMC	Agriculture Monitoring administration Centre
AMI	Advanced Metering Infrastructure
AMS	Asset Management System
AP	Applications Provider
API	Application Programming Interface
ARIB	Association of Radio Industries and Business
ARPU	Average Revenue per User
ATIS	Alliance for Telecommunications Industry Solutions
BMS	Building Management System
CCSA	China Communications Standards Association
CIS	Customer Information System
CL	Criticality Level
CMS	Cryptographic Message Syntax
CP	Care Provider
CPU	Central Processing Unit
DAP	Data Aggregation Point
DCS	Distributed Control System
DER	Distributed Energy Resources
DMS	Distribution Management System
DNP	Distributed Network Protocol
DP	Device Provider
DR	Demand Response
DRX	Discontinuous reception
DSO	Distribution System Operator
DAP	Data Aggregation Point
DB	DataBase
DTG	Digital TachoGraph
DVR	Digital Video Recorder
EGW	Energy GateWay
EHR	Electronics Health Record
EMS	Energy Management System
EP	Equipment Provider
EPBA	Equipment Provider Back-end Application
ESI	Energy Services Interface
ETC	Electronic Toll Collection
ETRI	Electronics and Telecommunications Research Institute
ETSI	European Telecommunications Standards Institute
ETWS	Earthquake and Tsunami Warning System
EU	European Union
eUICC	Embedded Universal Integrated Circuit Card
EV	Electric Vehicle
EVC	Electric Vehicle Charging
EVCE	Electric Vehicle Charging Equipment
EVC-SP	Electric Vehicle Charging Service Provider



FAN	Field Area Network
FFS	For Further Study
GPS	Global Positioning System
HAMS	Home Automation Management System
HAN	Home Area Network
HEM	Home Energy Management
HEMS	Home Energy Management System
HLR	High-Level Requirement
HMI	Human Machine Interface
HSM	Hardware Security Module
HV	High Voltage
I/F	InterFace
IAC	Irrigation Administration Centre
ICCID	Integrated Circuit Card Identifier
IEC	International Electrotechnical Commission
IMSI	International Mobile Subscriber Identity
IP	Internet Protocol
ITS	Intelligent Transportation System
LAN	Local Area Network
LATAM	Latin American
LDR	Low Data Rate
LG	Lucky Goldstar
MDMS	Meter Data Management System
MDM	Medical Device Manufacturer
MDN	Mobile Directory Number
MDMMS	Medical Device Monitoring & Management Service
MN	Middle Node
MNO	Mobile Network Operator
MSCN	M2M Service Capabilities Network
MSISDN	Mobile Station International Subscriber Directory Number
MSP	M2M Service Platform
MTC	Machine Type Communications
MV	Medium Voltage
M2M	Machine to Machine
NW	NetWork
PAN	Personal Area Network
PC	Personal Computer
PEV	Plug-in Electric Vehicle
PHEV	Plug-In Hybrid Electric Vehicle
PKCS	Public Key Cryptology Standards
PLC	Power Line Communications
PMU	Phase Measurement Unit
PPM	Privacy Policy Manager
QoS	Quality of Service
RL	Redaction Leve
IRTU	Remote Terminal Unit
SCADA	Supervisory Control And Data Acquisition
SDDTE	Small Data and Device Triggering Enhancements
SGCG	Smart Grid Coordination Group
SGIP	Smart Grid Interoperability Panel
SIM	Subscriber Identity Module
SLA	Service Level Agreement
SM	Smart Meter
SMS	Short Message Service
SN	Sleepy Node
SP	Service Provider
SW	SoftWare
T&C	Terms and Conditions
TSO	Transmission System Operator
TIA	Telecommunications Industry Association
TSDSI	Telecommunications Standards Development Society, India
TTA	Telecommunications Technology Association

TTC	Telecommunications Technology Committee
TV	TeleVision
UD	User Device
UE	User Equipment
UEPCOP	User Equipment Power Consumption OPTimizations
UIM	User Identity Module
USB	Universal Serial Bus
URI	Universal Resource Identifier
WAM	Wide Area Measurement
WAMS	Wide Area Measurement System
WAN	Wide Area Network
WCDMA	Wideband Code Division Multiple Access
WG	Wireless Gateway
WLAN	Wireless Local Area Network
3GPP	3rd Generation Partnership Project

---

## 4 Conventions

The key words “Shall”, “Shall not”, “May”, “Need not”, “Should”, “Should not” in this document are to be interpreted as described in the oneM2M Drafting Rules [i.1]

---

## 5 Energy Use Cases

### 5.1 Wide area, energy related measurement/control system for advanced transmission and distribution automation

#### 5.1.1 Description

Background:

- Phase Measurement Units (PMUs, aka Synchrophasors) in power electrical systems, is a technology that provides a tool for power system operators and planners to measure the state of the electrical system and manage power quality.
- PMUs are positioned across the high voltage (HV) transmission and Medium voltage (MV) distribution network, operated by transmission and distribution system operators (TSO/DSO) respectively, typically in a substation where network node connections are made and the distribution of load is of importance.
- PMUs usually generate bulk statistical information transmitted hourly or daily or event based. They are capable of continuously monitoring the wide-area network status online, so continuous information streaming data will be available to control centres from hundreds of PMUs at once which requires a stable communication network with sufficient capacity and quality.
- The communications network that is used to collect, monitor and control electricity power systems (HV transmission and MV Distribution power systems) are usually owned by Electricity TSO/DSO and are very secure and reliable.
- PMUs are sampled from widely dispersed locations in the power system network and synchronized from the common time source of a global positioning system (GPS) radio clock. PMUs measure voltages and currents at diverse locations on a power grid and output accurately time-stamped voltage and current phasors, allowing for synchronized comparison of two quantities in real time. These comparisons can be used to assess system conditions.

Description:

- This use case shows the feasibility of High voltage /MV supervision through the interconnection of PMUs especially via mobile broadband communication networks. Thus not requiring any additional TSO/DSO internal network extensions especially in remote sites.
- Through analysis of PMU power state information collected in operator control centres (TSO/DSO), the TSO/DSO can send control information to PMUs, in the same mobile broadband communication network, to control the power flow in the power system.

- Transmission delay of less than a second for the transmission of PMU measurements in near real time to TSO/DSO in the case of control centres.
- Black-out causes propagates within minutes and sometimes only seconds through entire national and even international transport & distribution networks. So the transmission of control is critical in the range of less than seconds.

### 5.1.2 Source

oneM2M-REQ-2012-0030R07 Wide area Energy related measurement/control system for Advanced transmission and Distribution Automation

*Note:* from ETSI TR 102 935 v2.1.1 [i.2]

### 5.1.3 Actors

- Energy system operators:
  - Transmission System Operator (TSO) is responsible for operation, maintenance and development of the transmission network in its own control area and at interconnections with other control areas, long-term power system ability to meet the demand, and grid connection of the transmission grid users, including the DSOs.
  - Distribution System Operator (DSO) is responsible for operation, maintenance and development of its own distribution grid and where applicable at the connections with other grids, ensuring the long-term ability to meet the distribution demand, regional grid access and grid stability, integration of renewables at the distribution level and regional load balancing (if that is not done by the balance responsible party).
- Communication operator (s) provider of the access network (Telcos)
  - System operators and/or providers of service layer platform(s) which can provide services/common functionalities for applications that are independent of the underlying network(s).

### 5.1.4 Pre-conditions

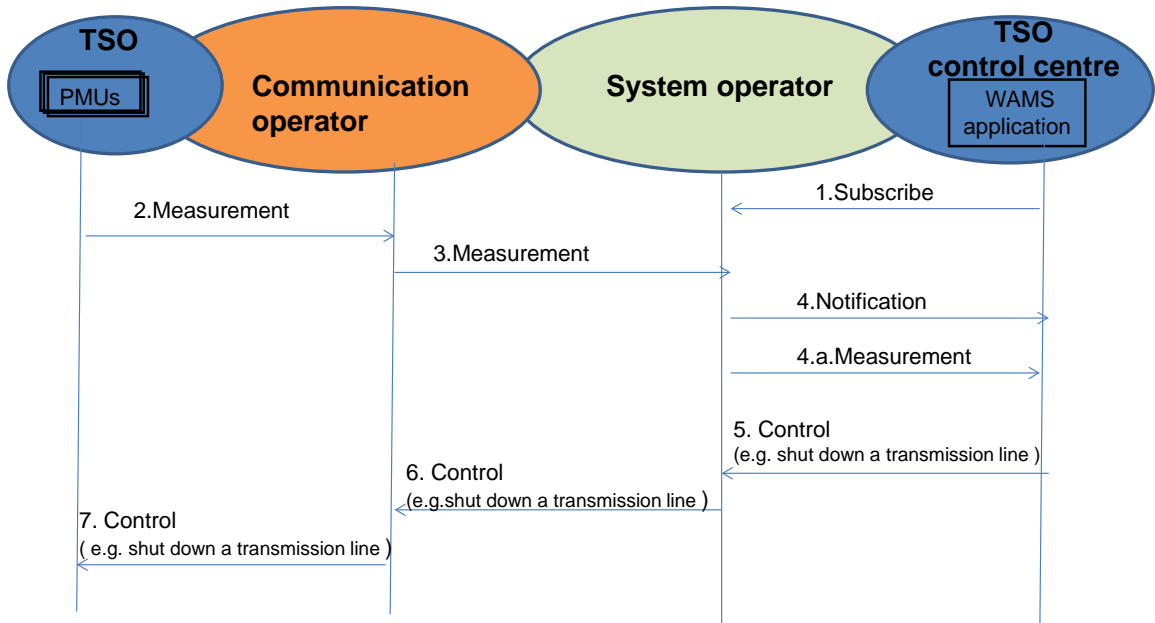
Communication/connectivity networks (phase network) to collect the measurements from PMUs to centres.

### 5.1.5 Triggers

System conditions deducted from the analysis of collected data trigger a counter measure action for example to curtail or reduce power flow in a HV/MV transmission.

### 5.1.6 Normal Flow

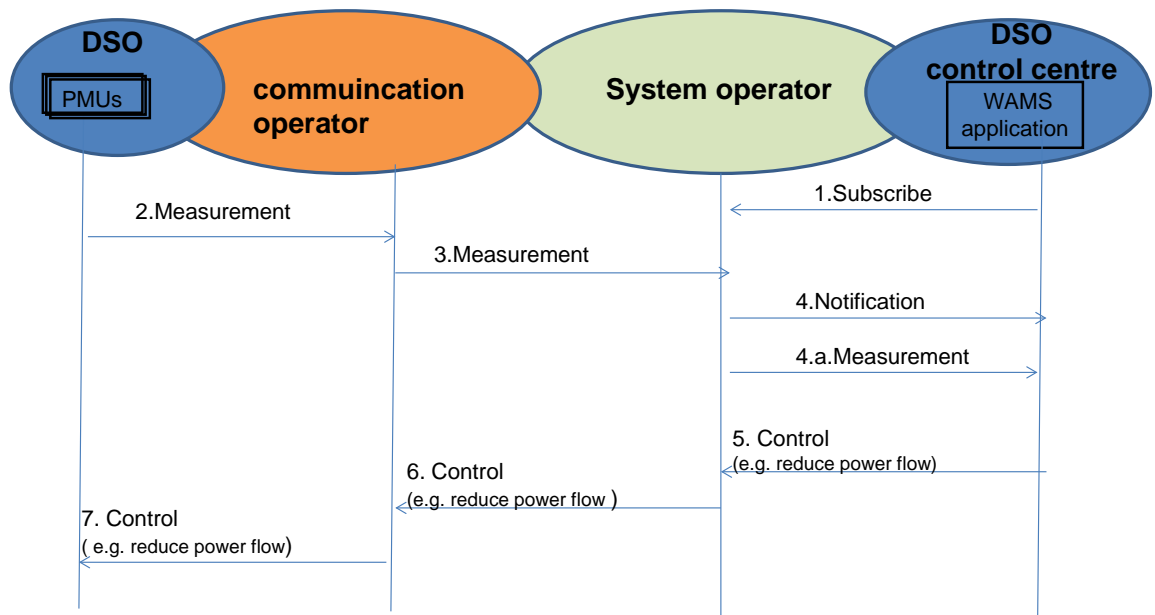
Interactions between actors and system required for successful execution of the use case or scenario.



**Figure 5-1 An example flow for the TSO scenario**

An example flow for the TSO scenario:

1. WAMS application subscribes to PMU data which is owed by the Transmission System Operator
2. Measurements requested are sent back through (service provider) Telco operator and System Operator to TSO centre for the WAM application
3. Measurements sent to the system operator are collected and can be stored by the operator.
4. Notification message is sent to WAMS application in TSO control centre when the system operator receives the measurement. WAMS application/TSO control centre can pull/push the data measurements
5. Based on measurements collected, WAMS application/ TSO control centre initiates a control command to shut down a transmission line under its controlled area
6. The Control command is sent to system operator where an appropriate communication network is selected to send the control command
7. Then control command is sent by system operator to the PMU under TSO controlled area to initiate the execution of the command e.g. the shutdown of a specific transmission line



**Figure 5-2 An example flow for DSO scenario**

An example flow for DSO scenario:

1. WAMS application subscribes to the PMU data
2. Measurements are sent through Telco operator
3. Measurements sent to system operator where they are stored.
4. Notification sent to WAMS application in DSO control centre when the measurements are received by system operator. WAMS application in DSO control centre pulls the measurements
5. Based on measurements collected WAMS application in DSO control centre, initiates a control command to reduce flow in a particular region under its controlled area.
6. Control command sent to system operator where an appropriate communication network is selected to send the control command.
7. Then control command is sent to the PMU under DSO control to initiate the execution of the command e.g. the change of power flow.

### 5.1.7 Alternative Flow

None

### 5.1.8 Post-conditions

Corrective or Restricted operation of power electrical network as a result of the preventive action because of the shut-down of (a part) power network.

### 5.1.9 High Level Illustration

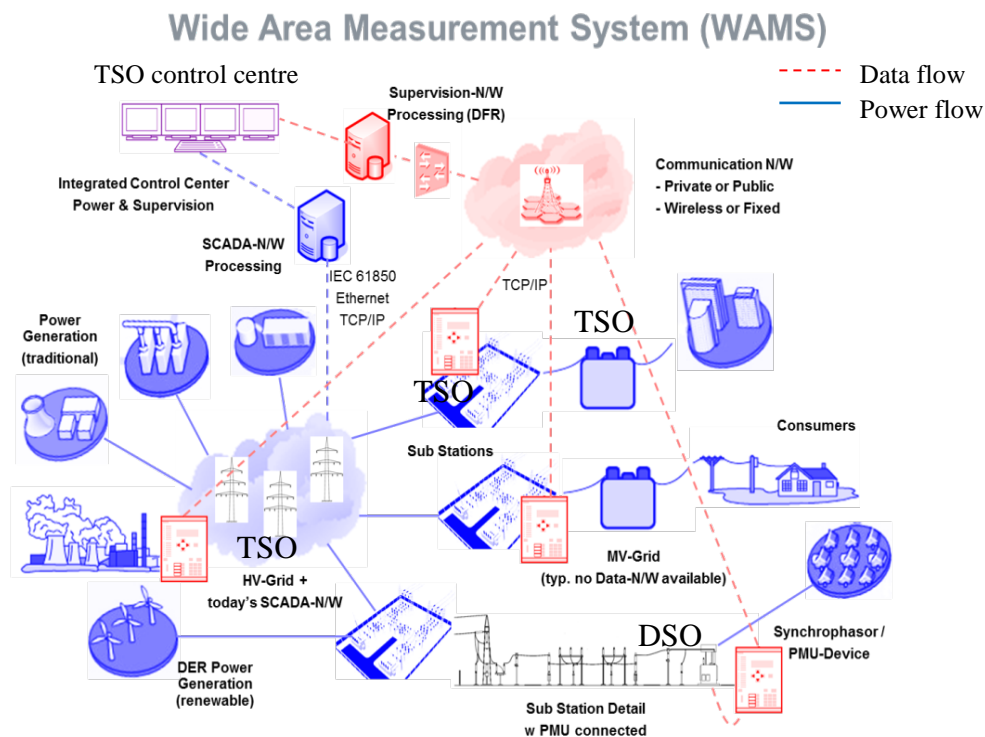


Figure 5-3 High Level Illustration of Wide Area Measurement System

### 5.1.10 Potential Requirements

Extracted from ETSI service requirements [i.3] (Ref TS102 689 V1.1.1) but suitable for this use case.

1. Data collection and reporting capability/function

The M2M System (e.g. be owned by System Operator) shall support the reporting from a specific M2M Device (e.g. PMU) or group of M2M Devices or group of M2M collectors in the way requested by the M2M Application (e.g. WAM) as listed below:

- a. a periodic reporting with the time period being defined by the M2M application;

- b. an on-demand reporting with two possible modes. One is an instantaneous collecting and reporting of data, the other one is a reporting of the data that were pre-recorded at the indicated specific time period;
- c. an event-based reporting e.g. transient fault (*Note specific time requirements FFS*)

#### 2. Remote control of M2M Devices

The M2M System shall support the capability for an Application to remotely control M2M Devices that support this capability; e.g. control power flow or shut down a regional power network to prevent a black-out event

#### 3. Information collection & delivery to multiple applications

The M2M System shall support the ability for multiple M2M Applications (in this use case the WAM) to interact with multiple applications on the same M2M Devices (in this case can interact with many PMUs) simultaneously

#### 4. Data store and share

The M2M System shall be able to store data to support the following requirements:

- a. Provide functionality to store and retrieve data.
- b. Establish storage policies for stored data (e.g. define maximum byte size of the stored data).
- c. Enable data sharing of stored data subjected to access control

#### 5. Security requirements

##### a. Authentication of M2M system with M2M devices/ /collectors

The M2M system shall support mutual authentication with M2M Device or M2M Gateway/collector. For example mutual authentication may be requested between a service providers/operators and the entity requesting the service. The parties may choose the strength of authentication to ensure appropriate level of security.

##### b. Authentication of applications on M2M devices with M2M applications on the network

When there is a request for data access or for M2M Device/Gateway access, the M2M Device or M2M Gateway access, the application on M2M Device or M2M Gateway shall be able to mutually authenticate or M2M Applications on the Network from which the access request is received.

##### c. Data integrity

The M2M System shall be able to support verification of the integrity of the data exchanged.

##### d. Prevention of abuse of network connection

M2M security solution shall be able to prevent unauthorized use of the M2M Device/Gateway.

#### 6. Privacy

The M2M System shall be able to protect confidentiality of collected information.

##### a. Security credential and software upgrade at the Application level.

i. Where permitted by the security policy, M2M System shall be able to remotely provide the following features, at the Application level:

- ii. Secure updates of application security software and firmware of the M2M Device/Gateway.
- iii. Secure updates of application security context (security keys and algorithms) of the M2M Device/Gateway.

- b. This functionality should be provided by a tamper-resistant Secured Environment (which may be an independent Security Element) in M2M Devices/Gateways supporting this functionality.

#### 7. Continuous Connectivity

The M2M System shall support continuous connectivity, for M2M applications requesting the same M2M service on a regular and continuous basis. This continuous connectivity may be de-activated upon request of the Application or by an internal mechanism in the M2M system.

## 1 5.2 Analytics for M2M

### 2 5.2.1 Description

3 The term “analytics” is often used to describe complex algorithms applied to data which provide actionable  
4 insights. Simpler algorithms may also provide actionable insights – here we use the term “compute” for them.  
5 Both “analytics” and “compute” may be used similarly by an M2M System to provide benefits to M2M  
6 applications. This use case uses a simple “compute” example to introduce the topic.

M2M application service providers may wish to use analytics for several purposes. There are many analytics providers who may offer their libraries directly to application service providers. However there are situations where application service providers may wish to apply analytics to their M2M data from devices before it is delivered to the “back-end” of the application “in the cloud”.

To satisfy M2M application service provider needs, a oneM2M system may offer compute/analytics capabilities which may be internally or externally developed. Furthermore, these compute/analytics capabilities may be geographically distributed. Benefits to M2M application service providers might include:

- Convenience - due to integration
- Simplicity - due to a cross-vertical standardized analytics interface
- Cost savings – due to resource minimization (of compute, storage, and/or network)
- Improved performance – due to offloading/edge computing

M2M service providers may also benefit by deploying distributed compute/analytics to optimize operations such as regional management e.g. device/gateway software updates.

The use case described below assumes:

- millions of devices continuously report M2M data from devices at geographically diverse locations
- the M2M application is interested in receiving only certain sets of data based upon changes in particular data elements.

Use of oneM2M computation and analytics for anomaly detection and filtering avoids the use of bandwidth needed to transport unnecessary device data to the back-end of the M2M application. To enable the oneM2M system to do this, the M2M application specifies:

1. Which device data (the baseline set) is needed to create a baseline (which is indicative of “normal” operation).
2. The duration of the training period used to set a baseline
3. The method to create/update the baseline
4. Which device data (the trigger set) is to be compared to the baseline
5. The method of comparison between the baseline set and the trigger set.
6. The variation of M2M data in comparison to the baseline used to trigger action
7. Which data (the storage set) is to be stored in addition to the data used in the baseline.
8. Which data (the report set, which may include data from the baseline set, trigger set and the storage set) which is to be reported to the M2M application upon trigger.
9. “Location directives” which expresses where the device data collection point, storage and compute/analytics program and libraries should be located. (Distributed, possibly hierarchical locations may be specified, and may be defined by max response time to devices, geographic location, density of convergent device data flows, available compute/storage capacity, etc.).
10. “Lifecycle management directives” for compute/analytics program and libraries instances e.g. on virtual machines.

The action by the oneM2M system in response to a trigger in this use case is to send the filtered report set to the M2M application; however, other alternative actions are summarized below (which would require different information from the M2M application).

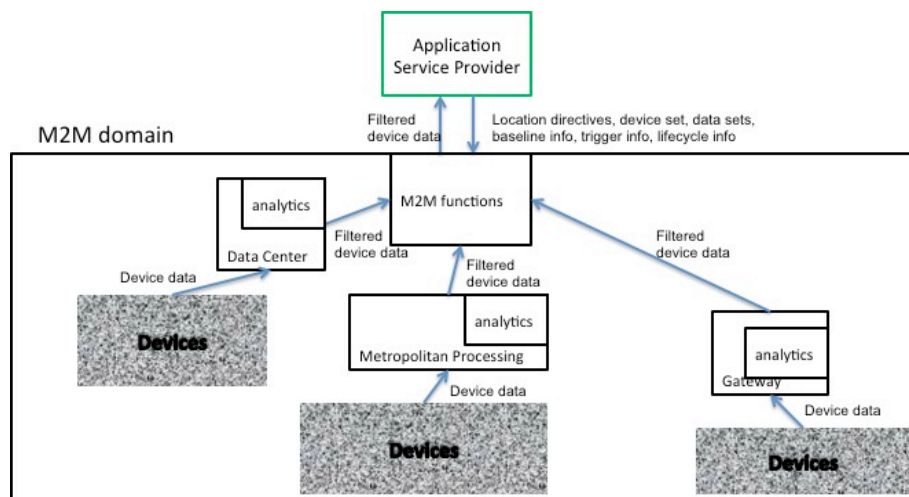


Figure 5-4 Analytics Use Case for M2M

52  
53 Example of distributed, non-hierarchical location of analytics use case – normal flow  
54 A hierarchical version of this use case would locate different compute/analytics at different levels of a  
55 hierarchy.

## 56 5.2.2 Source

57 oneM2M-REQ-2013-0102R03 Analytics for oneM2M

## 58 5.2.3 Actors

59 Devices – aim is to report what they sense  
60 Analytics library provider – aim is to provide analytics libraries to customers  
61 M2M application service provider – aim is to provide an M2M application to users

## 62 5.2.4 Pre-conditions

63 Before an M2M system's compute/analytics may be used, the following steps are to be taken:  
64 1. The M2M application service provider requests compute/analytics services from the oneM2M system.  
65 A request may include parameters required by analytics to perform computation and reporting, plus  
66 parameters required by the oneM2M system to locate and manage the lifecycle of the analytics  
67 computation instance (see 5.2.1).  
68 2. The oneM2M system selects a source Analytics library provider for, and obtains the appropriate  
69 analytics library.  
70 3. The oneM2M system provisions the appropriate analytics library at a location that meets the M2M  
71 application service provider's location directives.  
72 4. The oneM2M system generates a program based upon the M2M application service provider's request.  
73 5. The oneM2M system provisions the appropriate program based upon the M2M application service  
74 provider's request at the location(s) of step 3.  
75 6. The oneM2M system starts collecting M2M data from devices and inputs them into the provisioned  
76 compute/analytics program for the duration of the baseline-training period. A baseline is established,  
77 which may include bounds for M2M data ranges, bounds for frequency of M2M data received,  
78 bounds for relative M2M data values to other M2M data values, etc.

## 79 5.2.5 Triggers

80 Triggering is described within 5.2.7.

## 81 5.2.6 Normal Flow

82 1. The devices provide M2M data to the oneM2M system.  
83 2. The oneM2M system stores a set of M2M data (the storage set) from the devices  
84 3. The oneM2M system uses analytics to compare M2M data (the trigger set) from devices with the  
85 baseline.  
86 4. The oneM2M system determines whether the variation between the M2M data set and the baseline  
87 exceeds the specified bounds of the trigger condition, if it does then the following action occurs:  
88 5. The oneM2M system sends the requested M2M data (the report set), to the M2M application service  
89 provider.

## 90 5.2.7 Alternative Flow 1

91 The action to be taken by the oneM2M system following a trigger may be different than step 11 above.  
92 For example, the action may be to initiate conditional collection where for some duration or until some other  
93 trigger occurs.

- 94 A. A current collection scheme of device data is modified e.g. more frequent updates, or  
95 B. A new collection scheme is initiated

96 Other alternative actions may include, but are not limited to:

- 97  
98 • Initiating device/gateway diagnostics e.g. following a drop in the number of responding devices  
99 • Sending control commands to devices  
100 • Sending alerts to other oneM2M system services e.g. fraud detection  
101 • Sending processed (e.g. cleansed, normalized, augmented) data to the application



## 5.2.8 Post-conditions

Not applicable.

## 5.2.9 High Level Illustration

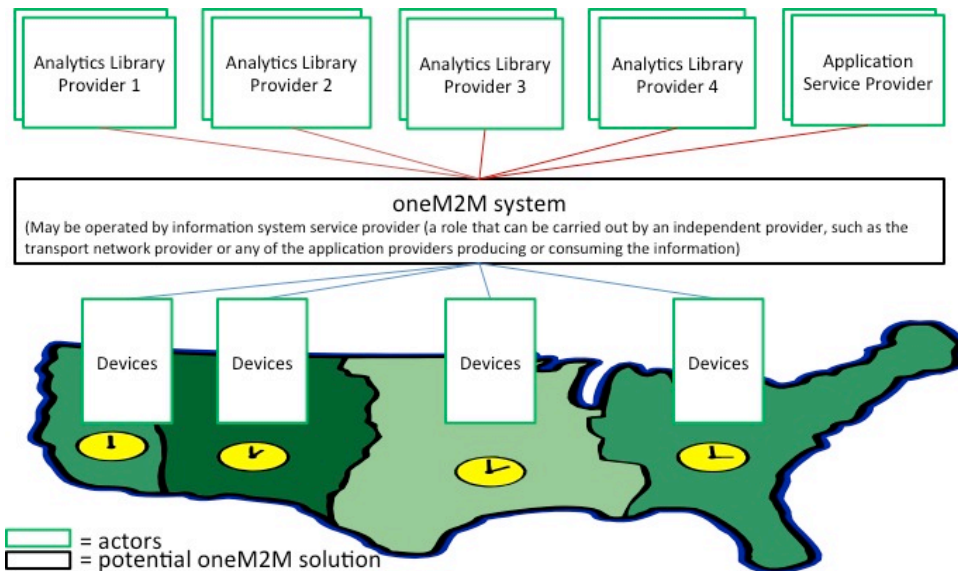


Figure 5-5 High level illustration of Analytics use case

### Concrete Example Oil and Gas

The above description is of the abstracted use case; a more concrete example is as follows:

Oil and gas exploration, development, and production are important potential use cases for M2M. To stay competitive energy companies are continuously increasing the amount of data they collect from their field assets, and the sophistication of the processing they perform on that data. This data can literally originate anywhere on Earth, is transported to decision makers over limited bandwidths, and often must be reacted to on real-time time scales. An M2M system can prove very useful in its ability to perform analytics, data storage, and business intelligence tasks closer to the source of the data.

Oil and Gas companies employ some of the most sophisticated and largest deployments of sensors and actuators networks of any vertical market segment. These networks are highly distributed geographically, often spanning full continents and including thousands of miles of piping and networking links. Many of these deployments (especially during the exploration phases) must reach very remote areas (hundreds of miles away from the nearest high bandwidth Internet connection), yet provide the bandwidth, latency and reliability required by the applications. These networks are typically mission critical, and sometimes life critical, so robustness, security, and reliability are key to their architecture.

Oil and gas deployments involve a complex large-scale system of interacting subsystems. The associated networks are responsible for the monitoring and automatic control of highly critical resources. The economic and environmental consequences of events like well blowouts, pipeline ruptures, and spills into sensitive ecosystems are very severe, and multiple layers of systems continuously monitor the plant to drive their probability of occurrence toward zero. If any anomalies are detected, the system must react instantly to correct the problem, or quickly bring the network into a global safe state. The anomalies could be attributable to many different causes, including equipment failure, overloads, mismanagement, sabotage, etc. When an anomaly is detected, the network must react on very fast timescales, probably requiring semi-autonomous techniques and local computational resources. Local actions like stopping production, closing valves, etc. often ripple quickly through the entire system (the system can't just close a valve without coordinating with upstream and downstream systems to adjust flows and insure all parameters stay within prescribed limits). Sophisticated analytics at multiple levels aids the system in making these quick decisions, taking into account local conditions, the global state of the network, and historical trends mined from archival big data. They may help detect early signs of wear and malfunction before catastrophic events happen.

Security is critical to Oil and Gas networks. This includes data security to insure all data used to control and monitor the network is authentic, private, and reaches its intended destination. Physical security of installations

141 like wells, pump stations, refineries, pipelines, and terminals is also important, as these could be threatened by  
142 saboteurs and terrorists.

143 There are three broad phases to the Oil and Gas use case: Exploration, Drilling and Production. Information is  
144 collected in the field by sensors, may be processed locally and used to control actuators, and is eventually  
145 transported via the global internet to a headquarters for detailed analysis.

### 146 **Exploration**

147 During the exploration phase, where new fields are being discovered or surveyed, distributed process  
148 techniques are invaluable to manage the vast quantities of data the survey crews generate, often in remote  
149 locations not serviced by high bandwidth internet backbones. A single seismic survey dataset can exceed one  
150 Petabyte in size. Backhauling this data to headquarters over the limited communications resources available in  
151 remote areas is prohibitive (Transporting a petabyte over a 20Mb/s satellite link takes over 12 years), so  
152 physical transport of storage media is currently used, adding many days of time lag to the exploration process.  
153 Distributed computing can improve this situation. A compute node in the field is connected to the various  
154 sensors and other field equipment used by the exploration geologists to collect the data. This node includes  
155 local storage arrays, and powerful processor infrastructures to perform data compression, analysis, and  
156 analytics on the data set, greatly reducing its size, and highlighting the most promising elements in the set to be  
157 backhauled. This reduced data set is then moved to headquarters over limited bandwidth connections.

### 160 **Drilling**

161 When oil and gas fields are being developed, large quantities of data are generated by the drilling rigs and  
162 offshore platforms. Tens of thousands of sensors monitor and record all conditions on the rig, and thousands of  
163 additional sensors can be located downhole on the drill string, producing terabyte data sets. Distributed  
164 compute nodes can unify all of these sensor systems, perform advanced real-time analytics on the data, and  
165 relay the appropriate subset of the data over the field network to headquarters. Reliably collecting, storing and  
166 transporting this data is essential, as the future performance of a well can be greatly influenced by the data  
167 collected and the decisions made as it is being drilled.

168 A subset of the data collected (wellhead pressure, for example) is safety critical, and must be continuously  
169 analysed for anomalies in real-time to insure the safety of the drilling operations. Because of the critical  
170 latency requirements of these operations, they are not practical for the Cloud, and distributed computing  
171 techniques are valuable to achieve the necessary performance.

### 173 **Production**

174 Once wells are producing, careful monitoring and control is essential to maximize the productivity of a field. A  
175 field office may control and monitor a number of wells. A computing node at that office receives real-time  
176 reports from all the monitoring sensors distributed across the field, and makes real-time decisions on how to  
177 best adjust the production of each well. Some fields also include injection wells, and the computing node  
178 closes the feedback loop between the injection rates and the recovery rates to optimize production. Some  
179 analytics are performed in the local computing node, and all the parameters are stored locally and uplinked to  
180 headquarters for more detailed analysis and archiving. Anomalies in sensor readings are instantly detected, and  
181 appropriate reactions are quickly computed and relayed to the appropriate actuators.

182 The Pump Station shown also includes a computing node. It is responsible for monitoring and controlling the  
183 pumps / compressors responsible for moving the product from the production field to the refinery or terminal  
184 in a safe and efficient manner. Many sensors monitor the conditions of the pipelines, flows, pressures, and  
185 security of the installation for anomalous conditions, and these are all processed by the local computing node.

### 187 **Conclusion**

188 The oneM2M Services Layer could offer “cloud-like” services to M2M Applications of computation/analytics  
189 functions commonly used across verticals, where those functions are optimally placed near to the sources of  
190 M2M data.

191 These services could include:

- 192 1. Advertisement of services to M2M Applications
- 193 2. Acceptance of M2M Applications’ directives over the “North-bound” interface.
- 194 3. Selection of where the requested computation/analytics functions are optimally placed
- 195 4. Provisioning and maintenance of virtual machine and computation/analytics functions (provided by  
196 oneM2M provider or 3rd party)
- 197 5. Redirection of M2M traffic to the virtual machine
- 198 6. Delivery of virtual machine output to other virtual machines or directly to M2M Applications (e.g. of  
199 filtered M2M data)

200 The M2M Applications and the M2M Service Provide may benefit from these services:

201 oneM2M Services Layer use of virtual machines on behalf of M2M Applications (e.g. to trigger new/modified  
202 data collection or device diagnostics or low latency M2M Device control)

203 oneM2M Services Layer use of virtual machines on behalf of the oneM2M Service Provider (e.g. optimized  
204 device management, fraud detection)

## 205 5.2.10 Potential requirements

- 206 1. The oneM2M system should be able to accept standardized inputs from M2M application providers which  
207 request compute/analytics services.
- 208 2. Note: Many Analytics APIs exist today, the most popular one being Google analytics service
- 209 3. The oneM2M system should be able to select analytics libraries from Analytics library providers.
- 210 4. The oneM2M system should be able to locate and run instances of compute/analytics programs and  
211 libraries at locations requested by M2M applications service providers.
- 212 5. The oneM2M system should be able to manage the lifecycle of instances of compute/analytics programs  
213 and libraries.
- 214 6. The oneM2M system should be able to steer device data to inputs of instances of compute/analytics  
215 programs
- 216 7. The oneM2M system should be able to take operational and management action as a result of analytics  
217 reports received.
- 218 8. The oneM2M system should specify supported compute/analytics triggers and actions.

219

## 220 5.3 Smart Meter Reading

### 221 5.3.1 Description

222 This clause provides selected Smart Meter Reading use cases

### 223 5.3.2 Source

224 oneM2M-REQ-2013-0217R02 Smart Meter Reading Use Case  
225 *Note:* use case information extracted from SGIP/OpenSG  
226 REQ-2015-0563 pCR on smart meter reading  
227

### 228 5.3.3 Actors

- 229 • Smart Meters (SM), Data Aggregation Points (DAPs),
  - 230 • Advanced Metering Infrastructure (AMI) Head-end,
  - 231 • Meter Data Management System (MDMS),
  - 232 • Customer Information System (CIS)
- 233

### 234 5.3.4 Pre-conditions

235 Availability of meter data.  
236 Smart Meters which are deployed in a block (e.g. same house, building, community, etc.) with the same  
237 behavior based on default configuration or charging policy could be assigned as a group.  
238

### 239 5.3.5 Triggers

240 Smart meter on-demand or bulk interval meter read request events

### 241 5.3.6 Normal Flow

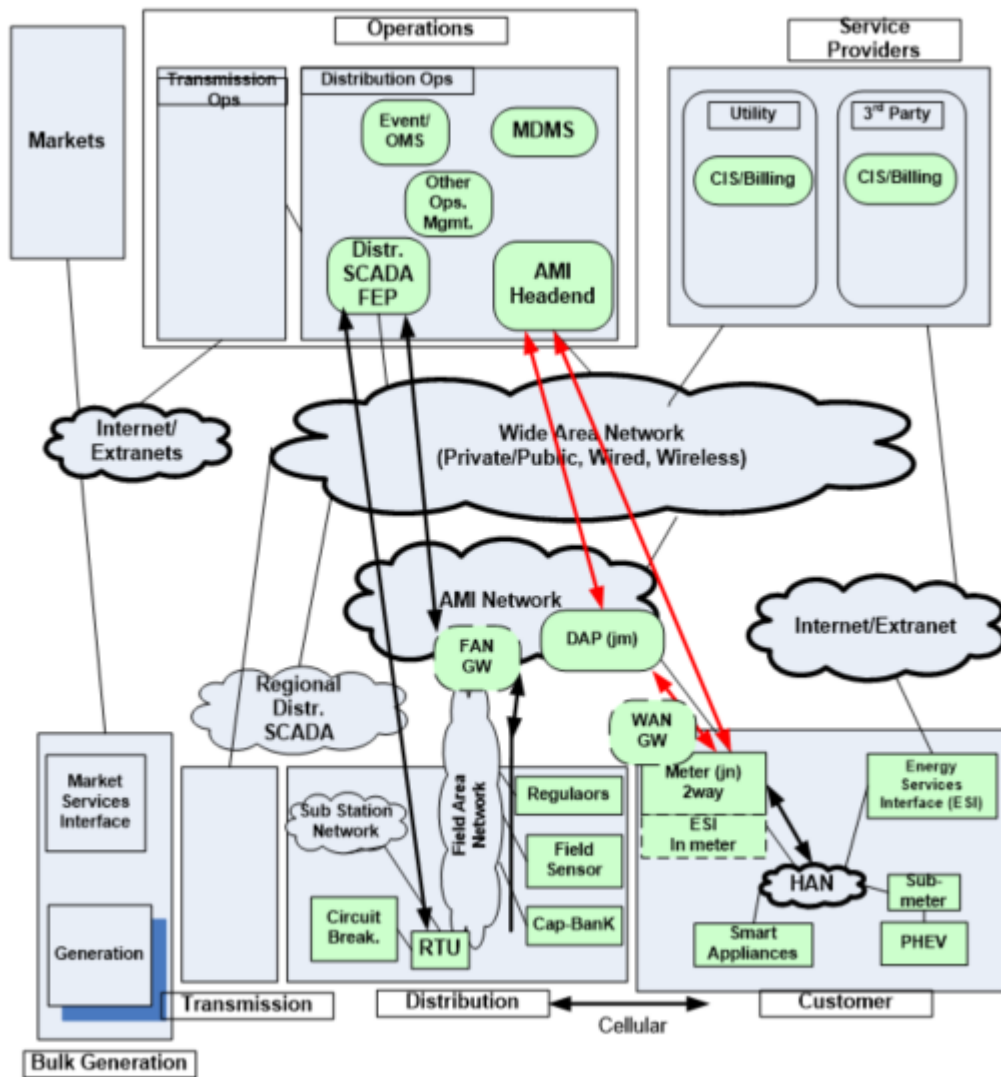
242 Smart Grid Interoperability Panel (SGIP) (<http://www.sgip.org>) and OpenSG users group  
243 (<http://osgug.ucaiuug.org/default.aspx>) have been leading this effort in North America. An informative  
244 document has been submitted to OneM2M based on the SGIP activity. In general, a number of external  
245 organizations such as the SGIP or the SGCG (Smart Grid Coordination Group) in Europe have been working  
246 to define use cases for Smart Grid (SG). Portals such as the Smart Grid Information Clearing House

247  
248  
249  
250  
251  
252  
253  
254  
255  
256  
257  
258  
259  
260  
261

(<http://www.sgiclearinghouse.org>) to assist with distributing information about smart grid initiatives in the US. The use-cases presented are derived in part from the above publicly available information.

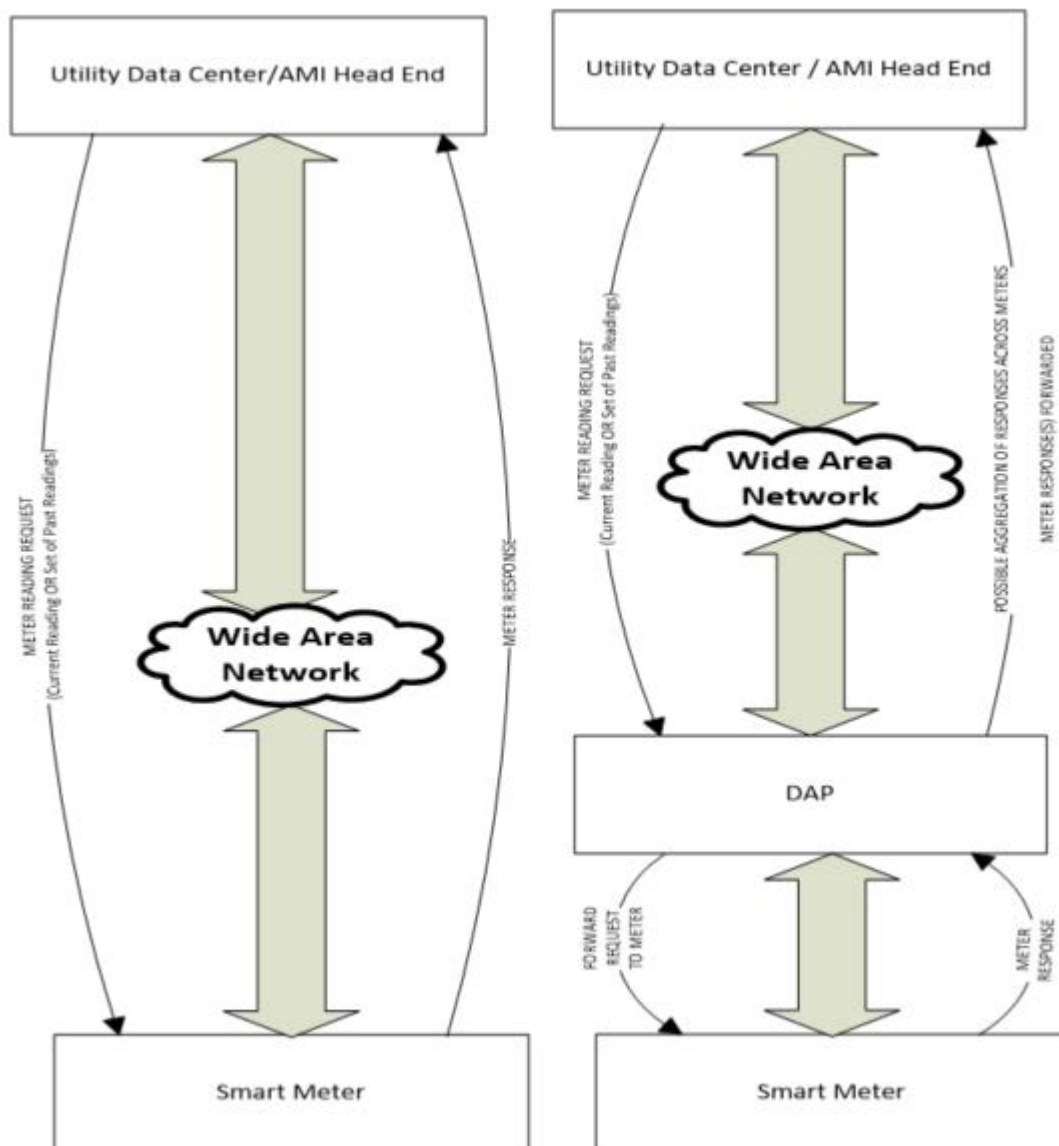
Figure 5-6 shows the conceptual actors/data flow diagram based on a more detailed diagram developed by SG-Net. The more detailed diagram developed by SG-Net can be seen in the associated submission related to SGIP-based Smart Grid Use Cases.

In Figure 5-7 each element is an “actor” that is communicating with another actor using the shown data flows. As an example, consider “Smart Meter” in the “Customer” quadrant (lower right). Smart Meter (SM) communicates with a number of other actors, such as a Data Aggregation Point (DAP) located in the AMI Network. The DAP can then transmit the aggregated data to the Utility Service Provider using the Wide Area Network. The meter reading information can reach the data centre for the Utility Service Provider via the AMI Headend which can forward the information to the MDMS which can coordinate with the CIS to store/retrieve meter data and to determine customer billing information. In certain variations such as cellular-based smart metering systems, a DAP entity may be bypassed, or merely serve as a pass-through for the information flow between the utility data centre and the smart meter.



262  
263  
264

Figure 5-6 Conceptual Actors/Data Flow Diagram



**Figure 5-7 Typical Smart Meter Reading Flows A (on left) and B (on right)**

Typically, a utility data centre processing application communicates end-to-end via the AMI Headend with a smart meter data application at the edge. Figure 5.3.6-2 shows two possible flows A and B depending on whether there is a DAP entity along the path from the Utility Data Centre / AMI Headend and the Smart Meter.

In flow A, the Utility Data Centre / AMI Headend can make a request to the Smart Meter directly. Typically there may be 3 to 6 such requests per day (typically < 10 times per day). The request could indicate that the current meter reading is desired. Alternatively, multiple meter readings over a period of time such as for a few hours (e.g. from 2 p.m. to 8 p.m.) for a given day or across days could be requested. The Smart Meter completes the request and communicates it back to the Utility Data Centre / AMI HeadEnd. Typical in such on-demand or bulk-interval read requests, a reasonably immediate response is desired of the order of a few seconds, so that there is not necessarily any significant delay tolerance allowed for the response. However, it is possible that, in current systems or in future systems, such requests could optionally carry a delay tolerance associated with the request depending on the urgency of the request. The size of the meter reading response can be of the order of a few tens to hundreds of bytes, and is also implementation dependent.

In flow B, the Utility Data Centre / AMI Headend can make a request to the Smart Meter that can be received via the DAP. Typically there may be 3 to 6 such requests per day (typically < 10 times per day). The request could indicate that the current meter reading is desired or that multiple meter readings over a period of time are

286 desired. The Smart Meter completes the request and sends its response to the DAP. This response from the  
287 Smart Meter to the DAP is typically desired in the order of 15 to 30 seconds, as suggested in the submitted  
288 informative document related to SGIP-based Smart Grid Use Cases. However the actual delay in processing  
289 can be implementation dependent across smart metering systems across the world. The size of the meter  
290 reading response can be of the order of a few tens to hundreds of bytes, and is also implementation dependent.  
291

292 In case that the Smart Meters belong to a group, there are two ways to distribute the request from the Utility  
293 Data Centre / AMI Headend to Smart Meters: the Utility Data Centre / AMI Headend sends a request to DAP  
294 then DAP distributes it to all Smart Meters, or the Utility Data Centre / AMI Headend sends same requests to  
295 all Smart Meters via DAP which acts as a router. There are several ways to submit the data from Smart Meters  
296 to the Utility Data Centre / AMI Headend: The DAP entity can buffer the data for some time, receive data from  
297 many meters, and then submit the aggregated data across meters to the Utility Data Centre / AMI Head End.  
298 The duration for which the DAP may buffer data can be implementation dependent, and could last for several  
299 seconds or minutes. In some variants, the DAP may serve merely as a router, so that it directly forwards the  
300 smart meter response to the Utility Data Centre / AMI HeadEnd without performing any aggregation tasks. In  
301 further variants, the DAP entity could be merely a virtual processing entity and not a physical one, where such  
302 a virtual entity could even potentially reside on the other side (not shown) of the wide area network associated  
303 with the Utility Data Centre / AMI Head End. For instance, the Utility Data Centre / AMI Headend could send  
304 a request to DAP for distributing it to all Smart Meters in a group, and if the DAP belongs to the third party,  
305 the DAP shall serve as a router to directly forward the smart meter response to the Utility Data Centre / AMI  
306 HeadEnd without performing any aggregation tasks.  
307

#### 308 Summary

309 To summarize, meter reading requests could request a single meter reading or a set of meter readings. Such  
310 requests may occur a few times (typically < 10) per day and can be of the order of a few tens of bytes. Meter  
311 reading responses can be of the order of a few 10s to 100s of bytes typically. Meter reading responses are  
312 typically expected in the order of a few seconds after reception of the request at the meter. Any delay tolerance  
313 associated with such requests can be optional or implementation dependent. In some system variants, a DAP  
314 entity may not exist at all so that the Utility Data Centre / AMI Head End communicates directly with the  
315 smart meter. In other end-to-end system variants, a DAP entity may serve as an intermediate processing or  
316 forwarding entity between the Smart Meter and the Utility Data Centre / AMI Head End. In such cases, the  
317 DAP entity may be either a physical or virtual processing entity in the end-to-end system and can assist with  
318 buffering and aggregating meter reading responses. The duration of buffering or aggregation at the DAP entity  
319 can be implementation dependent and could be of the order of a few seconds or minutes typically.  
320

### 321 5.3.7 Alternative Flow

322 None

### 323 5.3.8 Post-conditions

324 Not applicable

### 325 5.3.9 High Level Illustration

326 None

### 327 5.3.10 Potential Requirements

- 328 1. The M2M System shall be able to provide identity verification between the M2M device and the  
329 M2M server.
- 330 2. The M2M System shall be able to protect confidentiality of data (i.e. Smart Meter Response), even  
331 when DAP is deployed by the third party.  
332  
333  
334

## 335 5.4 Environmental Monitoring of Remote Locations to Determine 336 Hydropower

### 337 5.4.1 Description

338 Monitoring environmental parameters and effects in remote locations is of increasing interest due to the rapidly  
339 changing Global Climate and the world in general. Parameters such as temperate, pressure, water levels, snow  
340 levels, seismic activity have significant effects on applications such as green energy (wind and hydro power),  
341 agriculture, weather forecasting and tsunami warnings. The demand for remote monitoring information (real  
342 time and historical) has been increasing over the past decade and expected to increase exponentially in the  
343 foreseeable future.

344 Environmental monitoring is a M2M application where satellite is the only communications alternative as no  
345 other infrastructure is generally in such remote localities. This case study attached presents one solutions  
346 where satellite communication is commonly used for environmental monitoring. This is Hydro power  
347 generation through snow/water monitoring.

348 This attached paper provides an overview of the solution and how satellite is used to support this requirement.  
349 The document also outlines why the solution requires M2M remote satellite communications.

### 350 5.4.2 Source

351 oneM2M-REQ-2013-0123R02 Use-case Hydro-Power Monitoring Satellite

### 352 5.4.3 Actors

353 Energy companies

### 354 5.4.4 Pre-conditions

355 Two main requirements exist for remote monitoring in Hydro Power Generation. Firstly, there needs to be  
356 monitoring of the flow and supply of water to generate the power itself. Secondly, there needs to be monitoring  
357 of the environmental impact the hydro-electricity has on surrounding ecosystems for the storage of water and  
358 resulting change in natural flow.

359 Flow and Supply of Water: Availability and supply of water is fundamental to hydro generated power and is  
360 very seasonal and related to the regional climate. In cold climates such as Canada and Norway, water is  
361 supplied by snow where reservoirs are located in high locations and catchment areas cover extensive mountain  
362 regions. Snow levels, melting periods and supplies are inconsistent throughout the year. Reservoirs and storage  
363 facilities are designed to take into account seasonal inconsistencies from mother nature. In more tropical areas  
364 such as Brazil, tropical downfalls in the wet seasonal periods are important for flow management and are also  
365 seasonal.

366 Regardless of region, accurate sensors are critical to monitor water flow and supply such as rain fall, snow  
367 levels, snow temperature, snow wetness, reservoirs levels and other seasonal parameters. These sensor  
368 readings are critical to ensure Hydro companies can accurately predicate and monitor power generation levels.  
369 Sensor readings need to be sent back in near real time to Hydro processing plants to maintain operations. The  
370 location for the sensors are in mountainous and hard to reach areas that experience harsh environmental factors,  
371 partially high water/snow falls. Power or communication infrastructure is generally not available; therefore  
372 reliable satellite communication is the only option.

373 Sensor data is sent back consistently at short interval rates generally every five minutes from a number of  
374 multiple sensors in each location. Monthly usages in the region of 5 MB-10MB per month are typical  
375 depending on the number of sensor registers to poll and the M2M SCADA (supervisory control and data  
376 acquisition) communication protocol used (e.g. Modbus or priority protocol protocols used such as Totalflow).

377 Environmental impact that hydro-electricity has on surrounding ecosystems: Hydro-Electricity has the  
378 potential to affect the local ecosystems upstream and downstream from the generating plants. Government and  
379 world regulations are in place to ensure these systems minimize the impact on the local environment. Close  
380 monitoring and reporting of the surrounding areas are also part of the monitoring solution. Factors such as soil  
381 salinity, water levels, fish stock levels and erosion are some parameters that could be potentially monitored to  
382 ensure regulation and adhered to. This type of data is not critical for the power generation, however is required  
383 historically for trend analysis. Near real time communications is require for these types of sensors.

384 Sensor data is sent back long consistently interval rates generally every 30 minutes to 1 hour from a number of  
385 multiple sensors in each location. Monthly usages in the region of 1 MB-2 MB per month are typical,  
386 depending on the number of sensor registers to poll and the M2M SCADA communication protocol used.

387  
388  
389  
390  
391  
392  
393  
394  
395  
396  
397  
398  
399  
400  
401  
402  
403  
404  
405  
406  
407  
408  
409  
410  
411  
412  
413  
414  
415  
416  
417  
418  
419  
420  
421  
422  
423  
424  
425  
426  
427  
428  
429  
430  
431  
432  
433  
434  
435  
436  
437  
438  
439  
440

## 5.4.5 Triggers

Two triggers that initiate information being sent over this architecture.

- Constant polling and
- Conditional polling.

Constant Polling: Sensor polling rates are set by the Hydro operator. This information is used at the host to provide real time data as well as historical for trending analysis. Polling rates depend on the rate of change in environmental changes or how often data is required to make decision on flow rates through the Pembroke. Rates could be every few minutes up to few hours, but rates are constant. This data is very important to determine power requirements for the satellite terminal. The more data the more power that is required.

Conditional Polling: Information can be sent from the RTU based on specified events, sharp rise in water levels, temperate and any specific data. This data must be fed back to the Hydro control (host) in the event critical controls need to be made on the Hydro station.

## 5.4.6 Normal Flow

Remote Sensor/Satellite Terminal Integration: Remote sensors are normally connected to a Remote Terminal Unit (RTUs) that condition the sensors values into registers that are transmitted (over satellite) to a host. The RTU polls (or changes register value in some circumstances) register values from Programmable Logic Controllers (PLCs) that are connected to the aforementioned sensors. The RTU will then use a M2M (SCADA) communication protocol to send the register values to the host. SCADA protocol are designed to be very compact, only sending the minimum require data to the host, thus why serial based communication is popular. Modbus, DNP3 (Distributed Network Protocol), IEC 61850 [i.16] (used in electrical substations) or other priority based communication protocols are used and are generally based around serial communication to keep traffic to a minimum. IP is starting to become more popular to support these SCADA protocols.

The host resides in a corporate network of the Hydro provider, which analyses and presents this data into meaning information to make decisions on. The host is normally a hydro-power monitoring application designed specifically by the hydro provider that is integrated with the remote monitoring sites and controls for the Hydro plant. The host normally has a very advanced Human Machine Interface (HMI) to process data to a human operator, and through this, the human operator monitors water flow and controls the amount of water flowing through the penstock to the turbine.

As mentioned, RTUs communicate via either serial (RS-232/485) or IP layer 2 M2M SCADA protocols. Majority of modern based satellite communications systems support IP only layer two protocols and it is very common for RTUs to communicate via serial only. Terminals servers are usually placed in line between RTUs and satellite terminals where serial communication is required.

Satellite Service solution: L Band satellite service are the most popular used by Hydro plants in LATAM and North America. The L band satellite service operates over the L band frequency range (1.5GHz to 1.6GHz). This band is unique as it is not attenuated by weather where other high frequency band solutions operate in. Remote terminals in this application must be able to operate in wet tropical and cold snow ranges.

The terminal normally provides a direct IP network connection to the customer corporate control network (backhaul) via secure IP VPNs or leased line. A backhaul satellite solution is sometimes used for increased reliability. The L band satellite network must offers geographical redundancy for downlink earth station and backhaul infrastructure.

Satellite Terminal Solution: The L band satellite terminal must operate with extremely low power, less than 1W idle and 20W transmit. Majority of power used by remote terminals is used during the idle state. Solar power designs are suitable for the most modern L band satellite terminals terminal to operate in remote locations.

Remote terminal management and control is essential for this remote application. The terminal must continually ensure the terminal is on-net. If the terminal seems to be unable to transmit (or receive), the terminal automatically must reboots and reconnects itself to the network (known as watchdog). This removes the requirement to send someone to reboot the terminal. Remote management is conducted via out of band signalling. Terminal status, manual reboot and remote firmware updates are also essential of the operation of the remote terminal.

## 5.4.7 Alternative Flow

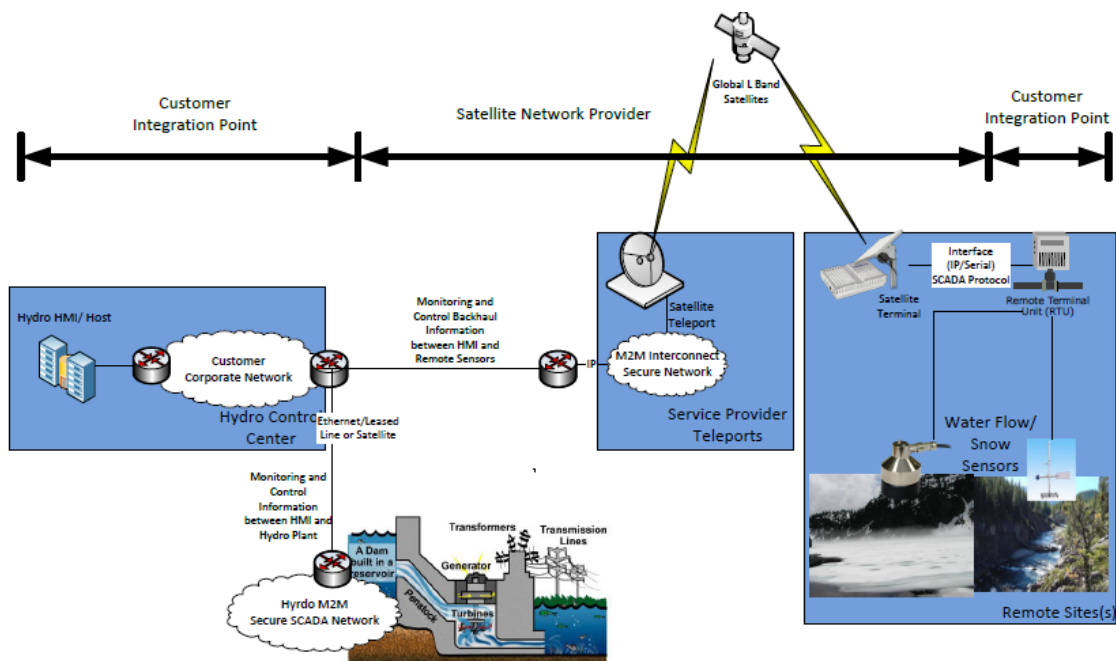
None



441 5.4.8 Post-conditions

442 Not applicable

443 5.4.9 High Level Illustration



444

445

446

Figure 5-8 High Level Illustration of Environmental Monitoring for Hydro-Power Generation using Satellite M2M

447 5.4.10 Potential Requirements

448

449

450

451

452

453

454

455

456

1. The M2M System shall provide mechanisms for ensuring round trip communications of specified times from sensors to actuators.
2. The M2M System shall support power constrained devices.
3. The M2M System shall support an M2M Application’s choice of communications transport characteristics e.g. Reliable or unreliable.
4. The M2M System shall support commonly used communications mechanisms for local area devices, e.g. RS-232/RS422.
5. The M2M System must provide communication availability to exceed 99.5% (1.83 days/year).

457 5.5 Oil and Gas Pipeline Cellular/Satellite Gateway

458 5.5.1 Description

459

460

461

462

463

464

465

466

This use case addresses a cellular gateway to transport oil and gas pipeline data to a backend server, to remotely monitor, manage and control devices equipped in the pipeline (e.g. meters, valves, etc.). Oil and gas companies can have meters are remote destinations that makes manual monitoring of the state of these meters as an expensive task to be pursued on a regular basis. Automated monitoring of oil and gas pipeline data can streamline the remote monitoring and management of these remote pipeline meters. When a fault is monitored on specific link of the pipeline network, it is necessary to open or shut the pipeline valve to block the link or to provide detour route. Also, when there is a necessity to change the quantity of oil and gas in pipeline, the valves should be damped through remote control.

467 5.5.2 Source

468

469

oneM2M-REQ-2013-0294R01 Oil and Gas Pipeline Cellular/Satellite Gateway  
 oneM2M-REQ-2013-0399 Additional Use Case for Oil and Gas UC

470

### 471 5.5.3 Actors

472 Oil and gas pipeline meters, valve controllers, cellular networks, backend servers, remote monitoring,  
473 management and control software

### 474 5.5.4 Pre-conditions

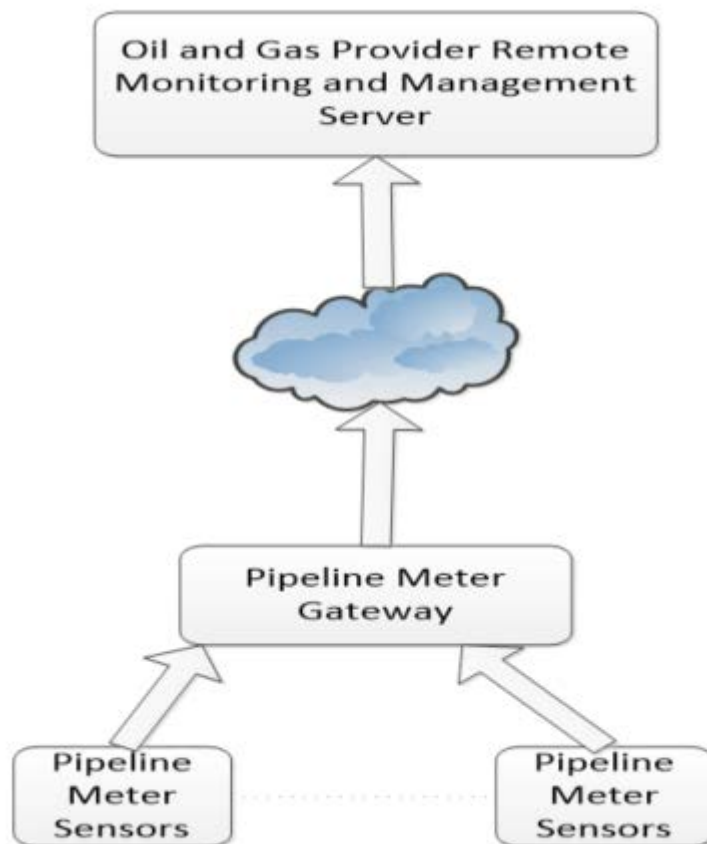
475 Cellular network connectivity, Satellite connectivity

### 476 5.5.5 Triggers

477 New pipeline sensor data requiring transport to a backend server  
478 Network dynamic access constraint or network utilization constraints or prior network access policy  
479 constraints or device energy minimization considerations can cause delay tolerant sensor data to be buffered  
480 (and aggregated if needed) at the gateway and transmitted at a later time  
481 Processing of recent measurements can result in remote requests for additional or more frequent measurements  
482 A firmware upgrade becomes available that needs to get pushed to the gateways

### 483 5.5.6 Normal Flow

484 Sensor data related to oil/gas quantity and quality, pressure, load, temperature, and consumption data is  
485 forwarded to backend server that is processed by a remote monitoring service associated with the oil and gas  
486 pipeline. Pipeline sensors and pipeline cellular gateways can communicate with each other wirelessly (if  
487 sensors and gateways are different nodes in the system). Pipeline cellular or satellite gateways can serve as  
488 aggregation points. Sensor data may be locally forwarded until it reaches a gateway or directly transmitted to  
489 the gateway depending on proximity of the sensor(s) to each gateway on the pipeline.  
490



491

492

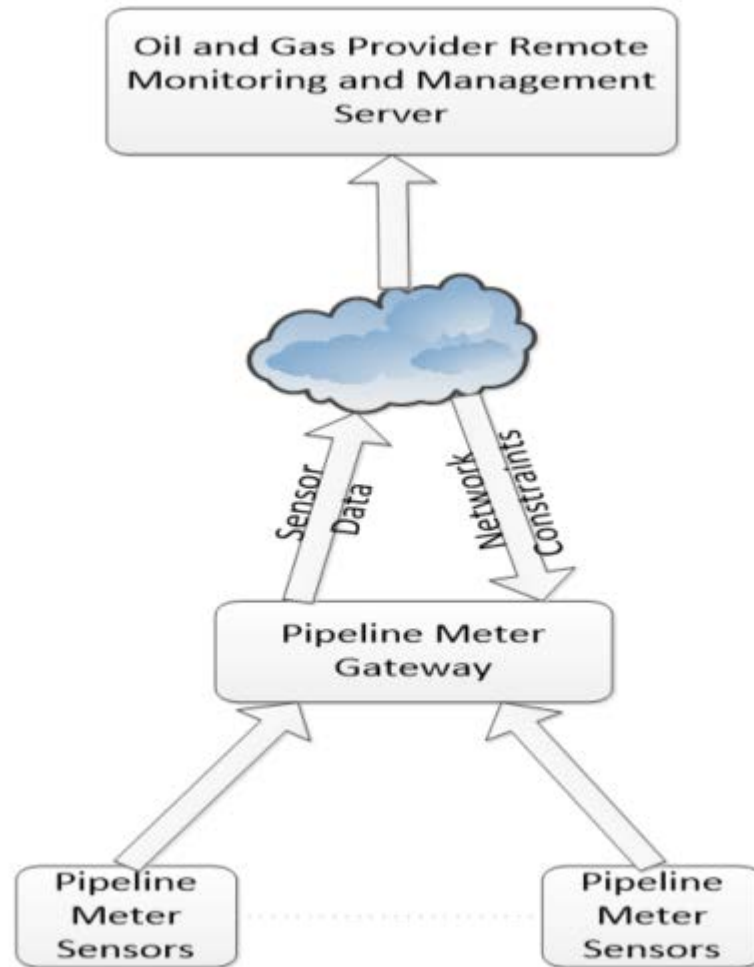
Figure 5-9 Flow - Oil and Gas Pipeline Gateway

493  
494  
495  
496  
497  
498

## 5.5.7 Alternative Flow

### Alternative Flow 1

Pipeline meter data can be stored, aggregated, and forwarded at an appropriate time based on network availability constraints or policy constraints or energy minimization constraints for the pipeline meter gateway. Transmission policies can be designed made to minimize network overhead.

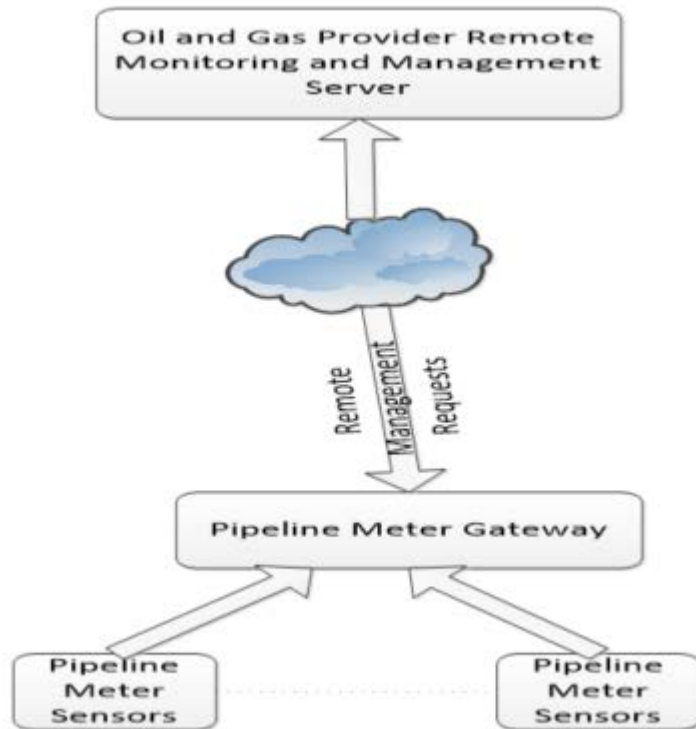


499  
500  
501  
502  
503  
504  
505  
506  
507  
508  
509

Figure 5-10 Alternative Flow 1 - Oil and Gas Pipeline gateway

### Alternative Flow 2

Pipeline meter data can be processed by the remote monitoring and management service. If any anomalies are detected, additional measurements could be triggered, or more frequent measurements could be triggered, or measurements by additional sensors can be triggered by the remote service manager. Firmware upgrades can also be provided by the remote management service. Remote measurement requests are typically triggered or polled only as absolutely needed so as to avoid the overhead of unnecessary polling and network congestion using such schemes with Normal Flow or Alternative Flow 1 preferred for reporting sensor data.

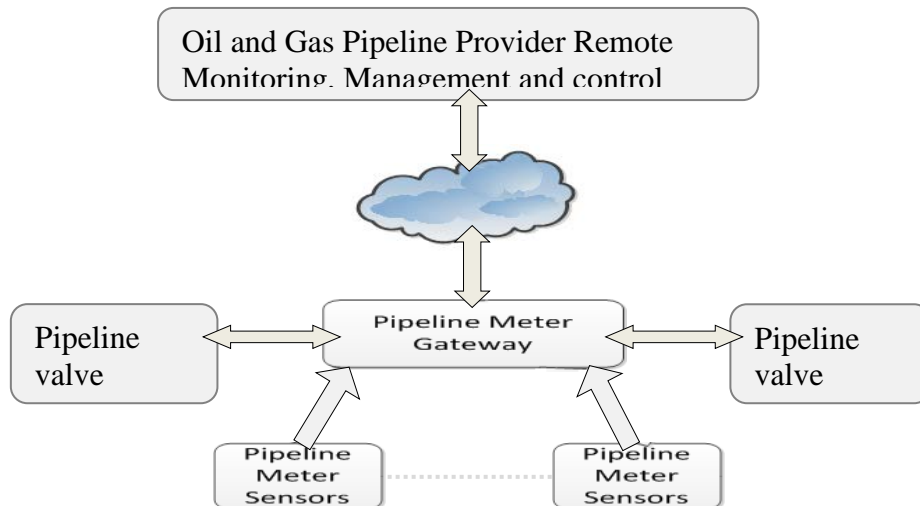


510  
511  
512  
513  
514  
515  
516  
517

Figure 5-11 Alternative Flow 2 - Oil and Gas Pipeline gateway

**Alternative Flow 3**

Valve control data should be delivered in real-time. For this purpose, Pipeline Meter Gateway can be used to transport valve control data as well. The Gateway should be connected to and control the targeted valve controllers.



518  
519

Figure 5-12 Alternative Flow 3 - Oil and Gas Pipeline gateway

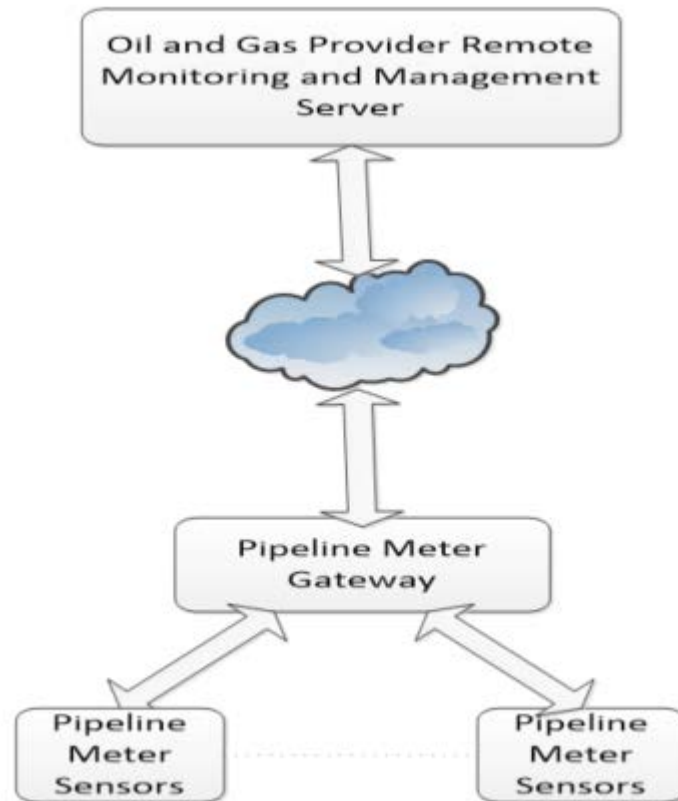
**5.5.8 Post-conditions**

Sensor data is stored in a database associated with the backend server. Remote monitoring service verifies the status of the different pipeline meters.

520  
521  
522  
523

- 524 1. Alternative Flow 1  
 525 Data is buffered and transmitted when the network or policy constraints or energy optimization constraints  
 526 allow transmission of delay-tolerant pipeline sensor data  
 527 2. Alternative Flow 2  
 528 More frequent or additional measurement request events can get triggered from the network based on  
 529 processing of recent measurement data.  
 530 3. Alternative Flow 3  
 531 When a valve controller received errored information from the gateway, the valve controller should send a  
 532 request of retransmission to the gateway.  
 533

534 **5.5.9 High Level Illustration**



535  
 536 **Figure 5-13 High Level Illustration - Oil and Gas Pipeline Gateway**  
 537

538 **5.5.10 Potential Requirements**

539 **Rationale**  
 540 This use case sets out from the presence of a gateway between one or more oil and gas pipeline sensor(s) and a  
 541 backend server. One gateway node may serve multiple pipeline sensors and data may be forwarded multi-hop  
 542 until it reaches a gateway. Data mules can collect data and dump the information at a gateway for  
 543 transportation. The ability to locally forward data wirelessly between nodes to a local aggregation point  
 544 serving as a gateway may be desirable depending on the location of sensor nodes and gateway nodes. Even  
 545 though the use case is assuming a cellular/satellite gateway, this restriction is not needed in general.

- 546 **Resulting requirements:**  
 547 1. The M2M system shall be capable of supporting gateway nodes that are capable of transporting sensor  
 548 measurements to back end servers.  
 549 2. The M2M system shall be capable of supporting static or mobile peer forwarding nodes that are capable of  
 550 transporting sensor measurements to a gateway node.  
 551

552 **Rationale**

553 Pipeline sensors can measure data at predetermined times. Pipeline sensors can also take measurements at  
554 random times or based on a request from a backend server to study the health of the pipeline. Therefore, new  
555 measurement data may become available at any time. When measurement data is available, the data can be  
556 processed locally to understand the criticality of the information. Based on the criticality/urgency of the  
557 information, the data can be transported over the network immediately or in a delay-tolerant manner. If an  
558 anomaly is detected with regard to the measured data, more frequent measurements may be taken locally or  
559 requested from the backend server, to continually assess the criticality of the situation. In case there is no new  
560 or relevant information, the system may choose not to transport unnecessary data to reduce network or reduce  
561 device energy usage.

562 **Resulting requirements:**

- 563 3. Whenever a pipeline sensor has measurement data available, it shall be possible for the sensor to send a  
564 request to the local pipeline gateway to transport new measurement data to the backend server.
- 565 4. Whenever measurement data is available, it shall be possible for the pipeline sensor or a local processing  
566 node/gateway to process the information and assess the urgency or criticality of the information, and tag  
567 the data appropriately to be critical/urgent or delay-tolerant.
- 568 5. Whenever measurement data is available that is determined to be critical/urgent, it shall be possible for the  
569 local gateway to send the information to a backend server as soon as possible (such as within in a few  
570 100s of ms). Delay-tolerant data shall be transported within the delay tolerance specified.
- 571 6. Whenever measurement data is available that is determined to be not important, the system may choose to  
572 not transport the data to reduce network usage or to reduce device energy usage.
- 573 7. More frequent measurements may be taken such as when one or more anomalies are detected in the  
574 system, which can result it more data and more frequent urgent transmissions in the system, depending on  
575 the criticality of the data.

576 **Rationale**

577 Local analytics service functions can be executed to process sensor information. A service function could  
578 consist of evaluation rules based on sensor data, and decisions based on rules associated with the data. An  
579 evaluation engine can process the rules to then decide whether/when to transmit data. Analytics processing can  
580 also be done in a distributed manner, with additional processing on the backend server, or configurability of  
581 the evaluation rules at the local gateway by the backend server.

582 **Resulting requirements:**

- 583 8. A local analytics service function can be executed on the local processing gateway based on evaluation  
584 rules associated with the measurement data, and decisions can be taken based on the processing.
- 585 9. A distributed analytics service function can be executed in collaboration with a backend server, where  
586 additional processing of data can be performed at the backend server, or where the rules associated with  
587 local processing can be configurable by a backend server.

588 **Rationale**

589 Incoming requests from the pipeline sensor to the pipeline gateway may not result in immediate forwarding of  
590 the data to the backend server if any of the following is applicable: Dynamically changing cellular network  
591 availability (coverage); cellular network utilization constraints (policies); device energy consumption or  
592 memory constraints. In one of the flows also the quality of the data to be transported (alert=high priority) was  
593 relevant for determining when the connection needs to be triggered. Categorization of traffic such as  
594 abnormal/urgent data such as a pipeline failure, versus normal traffic can be done at the gateway. Tagging and  
595 processing such traffic differently based on application/network/device constraints can be done at the local  
596 processing gateway. The system should allow a provisioning policy for handling categorized traffic at the local  
597 processing gateway. In many cases, in oil and gas pipeline systems, it is desirable to avoid unnecessary polling  
598 of the sensors and minimized network usage. Therefore it is desirable to enable to the system to determine  
599 policies for transmitting data such as a scheduled transmission versus an aggressive polling request based on  
600 the urgency of information, or aggregating information based on delay tolerance, to best utilize network  
601 resources.

602 **Resulting requirements:**

- 603 10. The local pipeline gateway needs to be capable to buffer incoming requests from the pipeline sensor for  
604 transporting data to the backend server and support forwarding them at a later time – which could  
605 potentially be a very long time in the order of hours, days or even more – depending on cellular network  
606 availability, cellular network utilization policies, device constraints
  - 607 11. The local pipeline gateway needs to be capable to accept parameters with incoming requests from the  
608 pipeline sensor which define a delay tolerance for initiating the delivery of the sensor measurements or  
609 parameters for categorizing sensor measurements into different levels of priority/QoS.
- 610  
611

- 612 12. The local pipeline gateway needs to be cable of receiving policies which express cellular network  
613 utilization constraints and which shall govern the decision making in the gateway when initiating  
614 connectivity over cellular networks.  
615 13. The local pipeline gateway needs to be capable to trigger connections to the cellular network in line with  
616 the parameters given by the request to transport data and in line with configured policies regarding  
617 utilization of the cellular network.  
618 14. The local pipeline gateway shall have the ability to categorize the data based on the abnormality/urgency  
619 or delay tolerance of the data.  
620 15. The local pipeline gateway can be provisioned with policies to handle categorized traffic.  
621

622 **Rationale**

623 The use case also describes a flow in which the backend server could initiate an action on the local pipeline  
624 gateway. The action could include a request for a measurement, or a firmware upgrade push to the gateway, or  
625 a change in the policies associated with data transportation. In particular, the ability to provide remote  
626 firmware upgrades or remote provisioning of policies is particularly desirable for these pipeline gateways at  
627 remote locations.

628 **Resulting requirements:**

- 629 16. The M2M system shall support transport of data from the backend server to the local pipeline gateway.  
630 17. The M2M system shall support of triggering a cellular connection to the local pipeline gateway in case the  
631 gateway supports such functionality  
632  
633

---

634 **6 Enterprise Use Cases**

635 **6.1 Smart Building**

636 **6.1.1 Description**

637 Smart building is a M2M service that utilizes a collection of sensors, controllers, allerter, gateways deployed at  
638 the correct places in the building combined with applications and server resides on the Internet to enable the  
639 automatic management of the building with just limited human labour. Smart building system can greatly  
640 reduce the cost involved in managing the building like energy consumption, labour cost. With the smart  
641 building system, services like video monitor, light control, air-condition control and power supply can all be  
642 managed at the control centre. Some services can be triggered automatically to save the precious time in case  
643 of fire, intruder, gas leak etc.

644 **6.1.2 Source**

645 oneM2M-REQ-2013-0122R04 Use Case Smart Building  
646

647 **6.1.3 Actors**

648 **M2M Service Provider:** A company that provides M2M service including entities like gateway, platform and  
649 enables the communication between them. The M2M Service Provider also exposes APIs for the development  
650 of all kinds of applications. The gateway provided by the Service Provider can be used to connect to different  
651 devices such as sensors, controllers.

652 **Control Centre:** The manage centre of the building, all data collected by the sensor is reported to the Control  
653 Centre and all commands are sent from the Control Centre. The Control Centre is in charge of the controlling  
654 of the equipment deployed around the building.

655 **Smart Building Service Provider:** A company that provides smart building services. A Smart Building  
656 Service Provider is a professional in the area. It is in charge of install the device all around the building, set up  
657 the Control Centre and provide the application that is used to manage the Control Centre and necessary  
658 training to workers in the Control Centre on how to manage the system. The Smart Building Service Provider  
659 has a business contract with the M2M Service Provider in utilizing the communication, gateway, M2M  
660 platform and APIs provided by the M2M Service Provider.

661  
662  
663  
664  
665  
666  
667  
  
668  
  
669  
  
670  
  
671  
672  
673  
674  
675  
676  
677  
678  
679  
680  
681  
682  
683  
684  
685  
686  
687  
688  
689  
690  
691  
692  
693  
694  
695  
696  
697  
698  
699  
700  
701  
702  
703  
704  
705  
706  
707  
708  
709  
710  
711  
712  
713  
714  
715  
716

## 6.1.4 Pre-conditions

The Smart Building Service Provider establishes a business relationship with the M2M Service Provider in using the gateway, M2M platform and APIs.  
The Smart Building Service Provider installs all the sensors, controllers, all over in and around the building and sets up the Control Centre in the building with the application to run the system.  
The Control Centre belongs to an estate management company and takes charge of several buildings all over the city. The building in the use case is one of them.

## 6.1.5 Triggers

None

## 6.1.6 Normal Flow

The light control of the building  
The Control Centre needs to control the light in the building by different areas and different floors. The Control Centre also needs to switch on and off all the light in the building. For the management of the lights, the Smart Building Service Provider deployed one gateway in each floor to get connection with the lights in the same floor. Each floor of the building has at least 100 lights and the building has 50 floors above the ground and 5 floors under the ground and each light can be switched separately. The lights in every floor is connected with the gateway using local WIFI network, the gateway is connected with the M2M platform using paid 3GPP network, the Control Centre is connect with the M2M platform using fixed network. A patrolling worker with a mobile device can access to the gateway's local network to switch the lights. The illustration can be seen in figure 6.1  
In order to switch the light from the whole floor, instead of sending request from the Control Centre 100 times, the Control Centre creates a group on the gateway of each floor to include all the light on that floor. As a result, the Control Centre could switch the light of a whole floor just by sending one request to the group created on the gateway, the gateway fans out the request to each light to switch them off.  
In order to switch the light of the building, instead of sending request from the Control Centre 5500 times, the Control Centre could create a group on the M2M platform to include all the groups created on each gateway on each floor. In this way, the Control Centre simply send one request to the group on the M2M platform, the group fans out the request to the group on every gateway, the group on the gateway fans out the request to each lights to switch it.  
The maintenance of the member of the group is the duty of a worker with a mobile device. Whenever a new light is installed, the worker adds the light to the group of the corresponding floor. Whenever a broken light is removed, the worker with the mobile device first searches the light from the group and removes the light from the group.  
The Control Centre creates the group in the purpose of controlling the lights, so the group is configured to accept lights only in case the group may cause unexpected result on other devices introduced to the group by mistake. For example, if the type of the group is configured as "light", then "wash machine" cannot be a member of the group. Because the commands to wash machine is much more complicated. If a wash machine is added to the group of lights by mistake, it may cause unexpected behavior to the wash machine.  
The add and remove of the members of the group of each floor is not necessary to be known to the Control Centre, but the Control Centre do know how to switch off the lights from the whole floor. In this way the Control Centre is exempt from the trivial task of maintaining each single light. However in the meantime, the administrator of the Control Centre can always make a list of all the lights and view their status from the Control Centre by retrieving from the group.  
**Intruder**  
With the deployment of smart building system, the number of patrollers is greatly reduced. For the security reason, a number of motion detector and cameras are installed all over the building.  
The motion detector and the cameras are configured to work together. During the period when certain floor of the building is in safe mode, whenever the motion detector detects a moving object, the camera captures a picture of the moving object immediately. The picture is sent to the Control Centre for the inspector to verify if it is an intruder or an automated image recognition system. As a result of fast reaction, the motion detector must trigger the photo shot as soon as possible.  
If the inspector sitting in the Control Centre finds that the object captured in the photo is a dog or a cat, he could just ignore the picture. If the figure caught in the picture is a stranger with some professional tools to break into a room. The inspector could send out a security team as soon as possible to the location based on the location reported from the motion detector.  
**Fire alarm**



717 In case of an emergency, the residents of the building need to be evacuated immediately. All the devices  
 718 related to a fire alarm need to be triggered almost at the same time. Whenever the fire sensor detects a fire in  
 719 the building, a chain group of devices associated with the fire detection shall be turned on simultaneously such  
 720 as the siren, the evacuation guide light, start the water pouring system, stop the elevator, cut off the electricity  
 721 at certain areas, send message to the hospital, call the fireman, in a way not interrupting each other. Due to the  
 722 possible latency and unavailability on the network to the Control Centre, the trigger of the devices on one floor  
 723 is configured in the gateway.  
 724 If only one fire sensor in one room of the building detects a fire with a range less than one square meter, siren  
 725 and water pouring system in the room would be switched on to alarm the resident to put out the fire. If lots of  
 726 fire sensors all detect fire together with smoke sensors, temperature sensors reporting unusual situations, the  
 727 whole fire alarm system will be triggered and all the residents in the building will be evacuated. If in the  
 728 meantime of a fire alarm, the sensors detect that the temperature is below the threshold which means the fire is  
 729 under control, the alarm can be cancelled automatically to all sirens and actuators to avoid the panic.  
 730 With the configuration on the gateway, the trigger of the devices can be very fast so that the damage caused by  
 731 the fire can be limited to its minimum

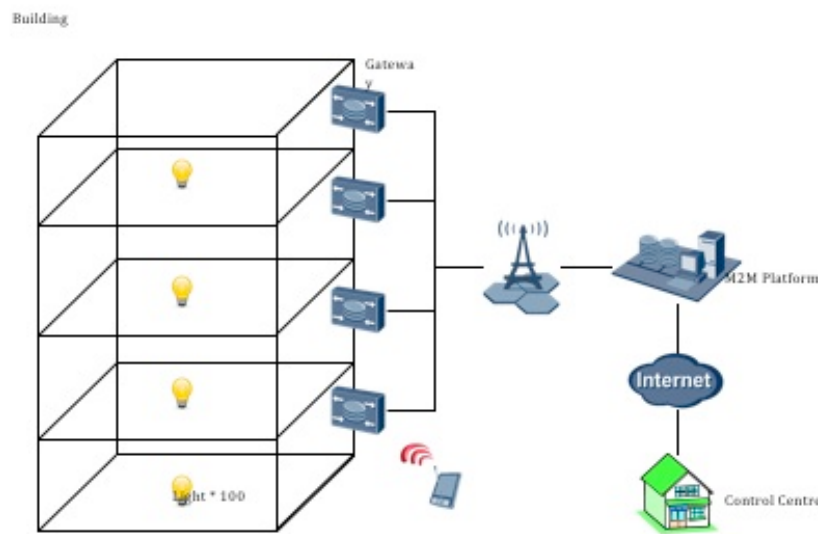
732 **6.1.7 Alternative Flow**

733 None

734 **6.1.8 Post-conditions**

735 Not applicable

736 **6.1.9 High Level Illustration**



737  
 738 **Figure 6-1 Smart Building Scenario**

739  
 740 **6.1.10 Potential Requirements**

- 741  
 742  
 743  
 744  
 745  
 746  
 747  
 748  
 749  
 750  
 751
1. The M2M system shall support the action chain harmonize a series of actions among a group of between devices, in a way not interrupting each other.
  2. The M2M system shall harmonize a series of actions based on certain conditions that support the action chain between devices shall subject to certain conditions.
  3. The M2M system shall support the devices to report their locations.
  4. The M2M system shall support a mechanism to group a collection of devices together.
  5. The M2M system shall support that same operations can be dispatched to each device via group.
  6. The M2M system shall support the members' management in a group i.e. add, remove, retrieve and update.
  7. The M2M system shall support that the group can check if its member devices are of one type.
  8. The M2M system shall support the group to include another group as a member.

## 752 6.2 Machine socialization

753

### 754 6.2.1 Description

755 A robot is designed to clean rooms in hotel. The task of the robot is to keep all rooms clean. If the hotel has  
756 only one robot, it has to clean rooms one by one. If the hotel has two robots, they will complete the task more  
757 efficiently if they cooperate with each other. If robot A has cleaned a room, it may inform the other robot that  
758 this room has been cleaned, so robot B can move to another room for clean job. This implies that if multiple  
759 robots share a same task, cooperation will improve the efficiency. As in the hotel scenario, the robots owner  
760 may not tell the robots explicitly that there exists another robot with the same task. So, firstly, the robot must  
761 have the capability to discover other robots and find out if they share the same task as itself. Secondly, a robot  
762 must realize what kind information will affect other robots behaviour, and it must transmit messages in order  
763 to share these information to other co-operators. For example, after a machine scan a room, it will find out the  
764 clean status of that room (clean or dirty), when a robot is cleaning a room or after it is cleaned, it will change  
765 the status of that room, the information will affect other robots' behaviour, because for any other robots it is  
766 unnecessary to go to a room that is being cleaned or has been cleaned by another robot. Thirdly, a robot must  
767 have the knowledge about the message interface of other robots. Only with this knowledge, it can send inform  
768 or command to another robots.

769 A cloud robot service platform may play an important role in this hotel scenario. Because the platform may  
770 help robots to discover each other, and the platform may initialize a powerful commander to optimize the job  
771 with multiple robots.  
772

### 773 6.2.2 Source

774 REQ-2015-0658R01  
775

### 776 6.2.3 Actors

- 777 • The clean robot is designed to keep all rooms clean. They may cooperate with each other directly or with the  
778 help of cloud robot service platform.
- 779 • Cloud robot service platform can discover the underline cooperation between machines.  
780

### 781 6.2.4 Pre-conditions

- 782 • Multi-robots share the same tasks or correlated tasks.  
783

### 784 6.2.5 Triggers

- 785 1. A robot discover another robot with the same or correlated tasks.  
786

### 787 6.2.6 Normal Flow

- 788 • A robot A is deployed in a hotel.
- 789 • Another robot B is deployed in a hotel.
- 790 • Robot A&B discover each other (the discovery is performed by themselves or aided by the cloud robot  
791 service platform)
- 792 • Robot A share information to robot B and Robot B share information to Robot A.
- 793 • The cloud robot service platform help to optimize the task process and help the robots to cooperate with each  
794 other.  
795

### 796 6.2.7 Alternative Flow

797 None  
798

799

## 6.2.8 Post-conditions

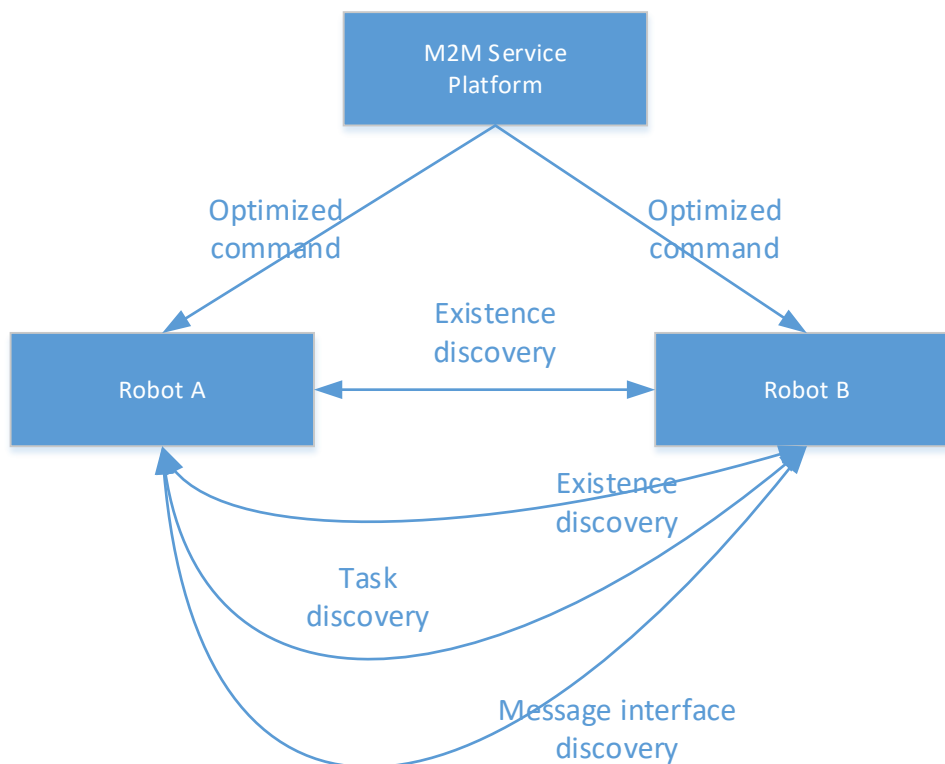
800

Not applicable

801

802

## 6.2.9 High Level Illustration



803

Figure 6-2 Machine Socialization

804

805

806

## 6.2.10 Potential Requirements

807

1. A M2M infrastructure shall be able to support the machine socialization functionalities, such as existence discovery, correlated task discovery, message interface discovery and process optimization for multiple machines with same tasks.

808

809

810

811

812

---

# 7 Healthcare Use Cases

813

## 7.1 M2M Healthcare Gateway

814

### 7.1.1 Description

815

This use case addresses a healthcare gateway to transport healthcare sensor data from a patient to a backend server and to also support bidirectional communications between a backend server via a gateway. The use case results in a set of potential requirements out of which some are specific to the fact that cellular connectivity is assumed between gateway and backend. Other than that, this use case is not restricted to cellular connectivity. This use case also addresses the situations where some of M2M System components are not available due to, for example, disaster

816

817

818

819

820

821  
822  
823  
824  
825  
826  
827  
828  
829  
830

## 7.1.2 Source

oneM2M-REQ-2012-0057R02 Use Case M2M Cellular Healthcare Gateway  
oneM2M-REQ-2012-0208R01 Correction to M2M Healthcare Gateway Use Case  
oneM2M-REQ-2013-0283R01 Addendum to M2M Healthcare Gateway Use Case  
oneM2M-REQ-2013-0185R03 Use case of peer communication  
oneM2M-REQ-2013-0356R01 Correction to M2M Healthcare Gateway Use Case,

*Note:* Several scenarios also supported by guidelines [i.13] defined in Continua Health Alliance should be covered by this use case.

831

## 7.1.3 Actors

832  
833  
834  
835  
836  
837  
838  
839  
840

- Patients using healthcare sensors
- Health-care gateways (also known as AHDs (Application Hosting Devices) in Continua Health Alliance terminology). Examples of healthcare gateways can include wall plugged devices with wired or wireless connectivity, or mobile devices such as smartphones.
- Operating healthcare service enterprise backend servers (equivalent to a WAN Device (Wide Area Network Device) in Continua Health Alliance terminology)
- Health care providers, operating healthcare enterprise backend servers
- Care givers and authorized users that could eventually access health sensor data
- Wide Area Network operator

841

## 7.1.4 Pre-conditions

842  
843  
844  
845  
846  
847  
848  
849  
850  
851

- Operational healthcare sensor(s) that requires occasionally or periodically transport of sensor data to a backend server.
- A local healthcare gateway is available that can be used to transport data from the healthcare sensor to a backend server. It is open as regards who owns and/or operates this local gateway. Different scenarios shall be possible supported (patient, healthcare provider, care-giver, M2M service provider, wide area network operator).
- Network connectivity is available for transporting healthcare sensor data from the local gateway to the backend server.
- A backend server that is hosting applications to collect measurement data and makes it available to care-givers, healthcare-providers or the patient.

852

## 7.1.5 Triggers

853  
854  
855  
856  
857  
858  
859  
860  
861  
862  
863  
864  
865  
866  
867  
868  
869  
870  
871  
872  
873

The following triggers could initiate exchange of information according to the flows described further-below:

- Patient-initiated measurement request (Trigger A). In this case, the patient decides to take a measurement and triggers the processing in the system.
- Static configured policy at a healthcare gateway that requests patient to initiate measurement (Trigger B). This can be an explicit message from the gateway device to a patient device, or it could just an indicator on the gateway itself such as a pop-up message or an indicator light requesting measurement.
- Static configured policy at a healthcare gateway that directly requests sensor data without patient intervention (Trigger C). This can be used in conjunction or in lieu of Triggers A or B. Some sensor data may be measurable or accessible without patient intervention so that the gateway merely needs to communicate with one or more sensors to obtain the data.
- Patient monitoring app on healthcare service backend server that triggers generation of sensor data (Trigger D).
- Dynamic patient monitoring request from the healthcare service provider (Trigger E).
- Availability of new patient healthcare data at a healthcare gateway that requires transport to a backend server.
- Availability of new patient healthcare data at a backend server that requires sharing with authenticated users such as a nurse/doctor (healthcare provider) and a patient's relative (such as a child care-giver).
- Health care service provider needing to contact patient to take measurements.
- Analysis of healthcare patient sensor info or trends that triggers the need to take action on behalf of patient (for example determination of a deteriorating health condition).
- QoS-aware data buffering policy on the healthcare gateway.

- 874 • Network-aware and/or device-aware delay-tolerant data management policy on the healthcare  
875 gateway. Network dynamic access constraints or network utilization constraints or prior network  
876 access policy constraints or device energy minimization considerations can cause delay tolerant  
877 sensor data to be buffered (and aggregated if needed) at the gateway and transmitted at a later time.
- 878 • Failure in the components of the M2M System for the healthcare service. (e.g. functional failure in  
879 Wide Area Network, functional failure in Healthcare Service Backend Server).

880  
881 The following clauses describe different flows that are possible in the m2m healthcare gateway system. For  
882 each flow, the events corresponding to the flow are high-lighted in the corresponding figure. Other events may  
883 be shown in a figure that are preserved to reflect the different types of processing that can occur in the system,  
884 with new events added in each subsequent figure to increase the complexity of the system. The high-level  
885 illustration provides a comprehensive summary description of the overall system.

## 886 7.1.6 Normal Flow

887 A measurement of the healthcare sensor is initiated as shown in 7-1. Patient can initiate the generation of  
888 sensor data such as taking a glucose meter measurement (Trigger A). The measurement may also be initiated  
889 based on some pre-defined schedule.

- 890 1. At the healthcare gateway (Trigger B or C).
- 891 2. The healthcare sensor data is forwarded to a backend server by a healthcare-gateway. If the data has a QoS  
892 indicator such as dynamic latency/bandwidth and/or delay tolerance, the gateway can determine whether  
893 to send the data immediately, or whether to buffer and send the data at a later time. Buffered data can be  
894 aggregated with past data or future data for a future aggregated transmission over the network. In  
895 wireless/cellular networks, aggregated transmissions can reduce the utilization of the network by  
896 requesting access to the network less frequently.
- 897 3. Measured data (or processed/interpreted versions of the data) that arrives at the healthcare service  
898 enterprise backend server may need to be forwarded to authorized subscribers – such as family care-giver  
899 or a nurse/doctor – via notifications. Subscriptions can be set up in advance, and configured at the backend  
900 server, so that when the data arrives, the subscribers can be notified. Filters can be associated with the  
901 subscriptions, so that only selective data or alert information can be sent to subscribers.  
902

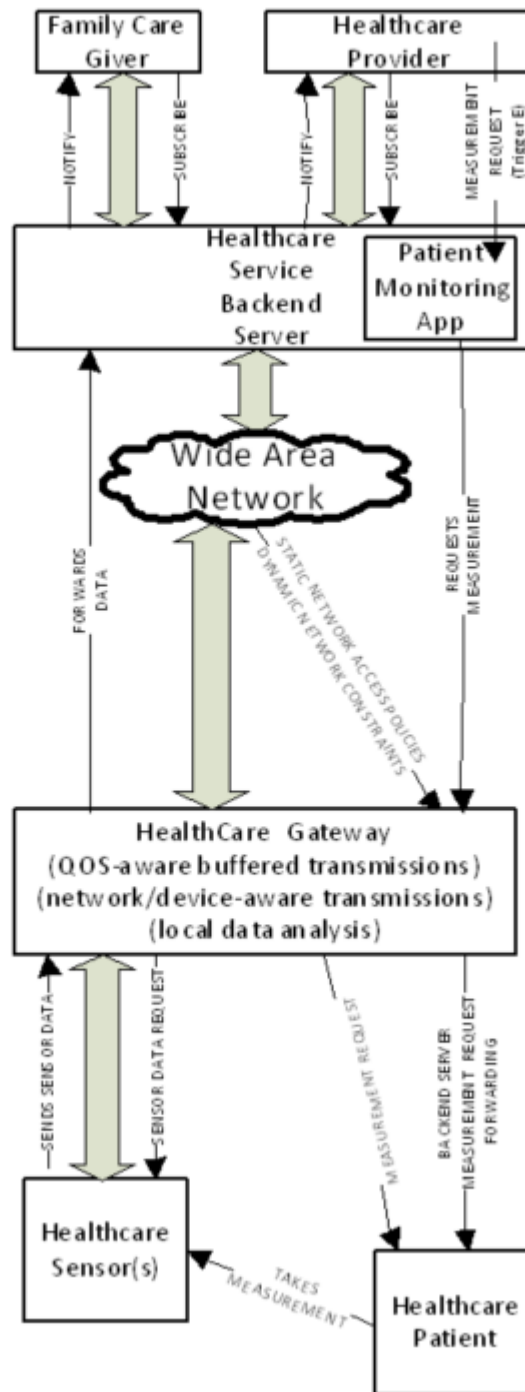


Figure 7-1 Healthcare Measurement Data Processing Flow

### 7.1.7 Alternative Flow

**Alternative Flow 1**– Network/Device-aware transmissions

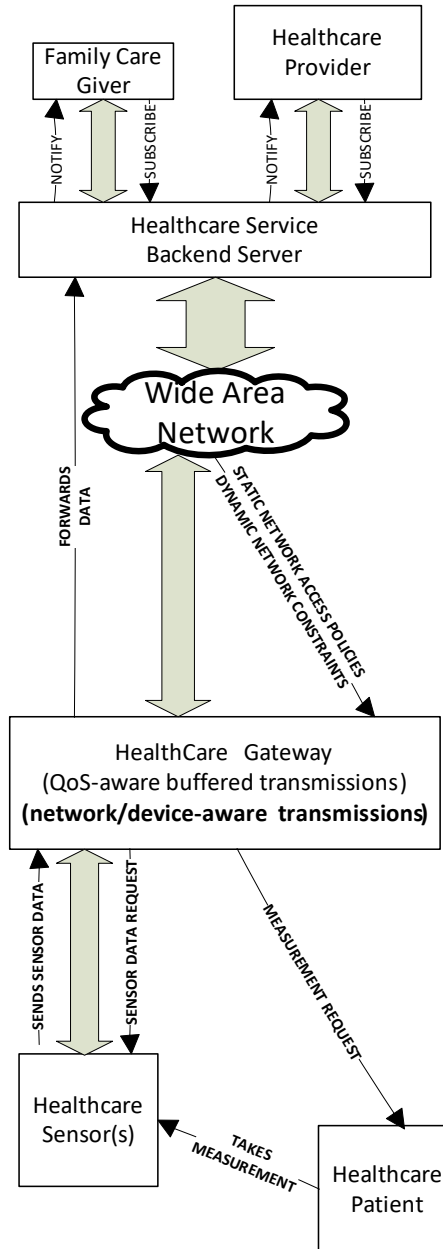
The flow in figure 7-2 depicts network/device-aware constraint processing in the system. This flow is the same as the regular flow with the following exceptions: The healthcare sensor data may need be stored on the gateway and forwarded at a future time based on one or more of the following factors:

- delay tolerances associated with the data.
- network policy constraints (efficiency, avoidance of peak loads, protection of spectrum).
- device constraints (energy consumption, data tariff).

915  
916  
917  
918  
919  
920  
921

- temporary lack of coverage of network connectivity.

Multiple measurements can be aggregated and transmitted together at a future time. Measurements can be taken with or without patient intervention and sent to the healthcare gateway. As measured data arrives at the healthcare gateway, its QoS indicators such as dynamic latency/bandwidth and delay tolerance can be processed. Delay tolerant data can be buffered and aggregated with past and future delay-tolerant data, with network/device-aware constraints can be applied to determine an appropriate time to transmit the data.



922  
923

Figure 7-2 Network/Device-aware Flow

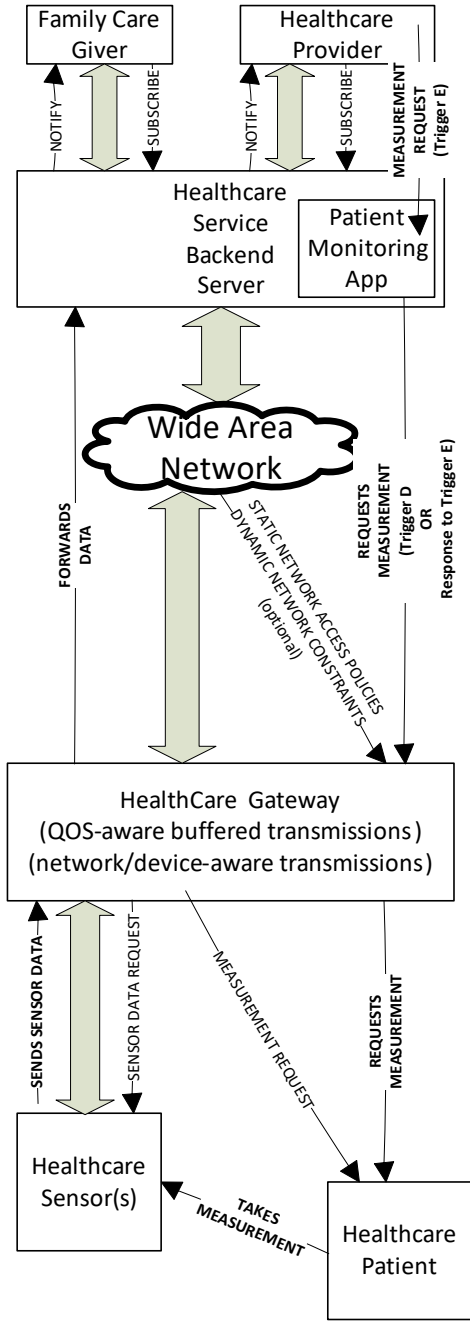
924  
925  
926  
927  
928  
929  
930  
931  
932  
933

### Alternative Flow 2– Remote Monitoring

Figure 7-3 depicts the event flow for remote monitoring from the healthcare service enterprise backend server. The backend server may expect the patient to submit sensor data periodically or with a pre-defined schedule. In the absence of a typically expected sensor data event, the backend server can trigger an event to request the patient to take a measurement. In this case, the trigger (Trigger D) arrives over a wide-area-network from the patient monitoring app on the healthcare service backend server delivered to the healthcare gateway. The patient monitoring app could generate this request based on a statically configured policy to request measurements or due to some dynamic needs based on processing of previous patient data.

934  
935  
936  
937  
938  
939  
940  
941  
942  
943  
944  
945  
946  
947

Optionally, the healthcare service provider may generate a measurement request (Trigger E) that can be received by the patient monitoring app on the backend server, which can subsequently submit a request over the wide area network for the patient monitoring request to the healthcare gateway. The healthcare gateway forwards the received request to the patient. In many cases, it is possible that a device associated with the patient, such as the healthcare cellular gateway, or a smartphone connected to the gateway, does not always have an active network connection, and that such a device may be asleep. In such a case, the measurement request can arrive with a wakeup trigger (such as using an SMS) (also called “shoulder tap” in Continua Health Alliance terminology) to the healthcare gateway, which can then establish connectivity with the backend server to determine the purpose for the trigger, and then subsequently process the patient measurement request. The patient subsequently takes the sensor measurement upon receiving the request. Alternatively, some sensor measurements could be taken without patient intervention. Measured sensor data is then received at the healthcare gateway, and subsequently transmitted based on processing the QoS/Network/Device-aware constraints for transmission.



948  
949  
950  
951

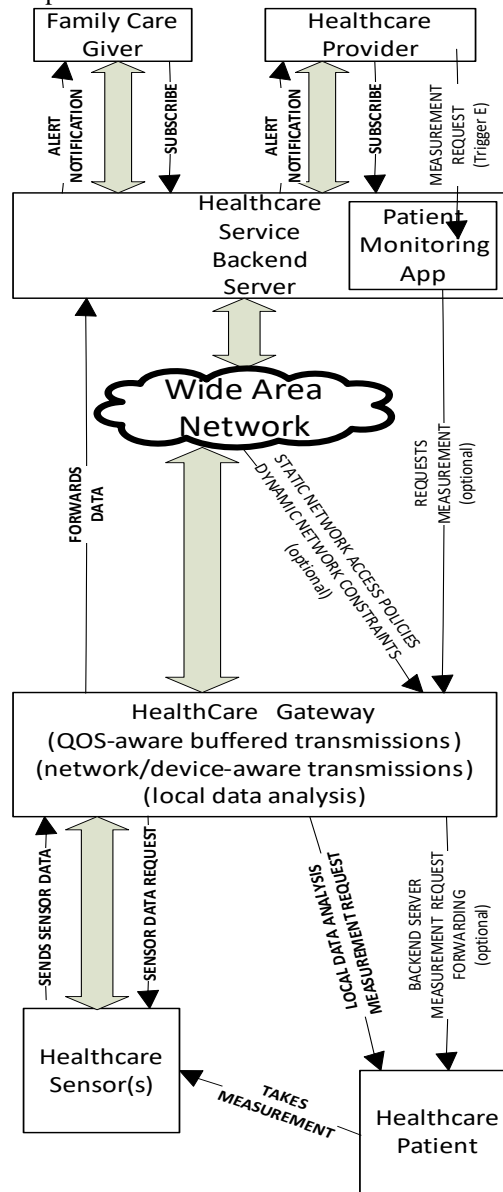
Figure 7-3 Remote Monitoring Flow

Alternative Flow 3 Local Gateway Data Analysis



952  
953  
954  
955  
956

Figure 7-4 illustrates a Local Gateway Data Analysis flow of events. The local gateway node can continuously process the data that it forwards. It can have smart algorithms to detect health anomalies associated with the patient. In case no anomalies are detected, the health sensor data may only be forwarded occasionally (see also alternative flow 1). In case an anomaly is detected, the local gateway needs to send an alert to the health care provider or the care-giver or to the patient if desired.



957  
958

**Figure 7-4 Local Gateway Data Analysis Flow**

959  
960  
961  
962  
963  
964  
965  
966  
967  
968  
969  
970  
971

#### **Alternative Flow 4 – Partial Failure Case**

Figure 7-5 illustrates a partial system failure, i.e. the failure of Healthcare Service Backend Server and/or the failure of the connection between Healthcare Gateway and Wide Area Network. In this situation, nevertheless, components of the healthcare system that are not in failure should continue their normal operations. Examples of the ‘normal operation’ are as follows:

1. Reports from Healthcare sensor are received by and stored in Healthcare Gateway
2. Notification from Healthcare Gateway (e.g. Measurement triggers) is forwarded to Patient
3. If the messages transmitted between Healthcare Sensors and Healthcare Gateway were encrypted before the failure for the privacy of patients, that encryption should be maintained after the failure. (c.f. For maintaining the security mechanism in an isolated domain, a locally operable key management mechanism can be introduced.)

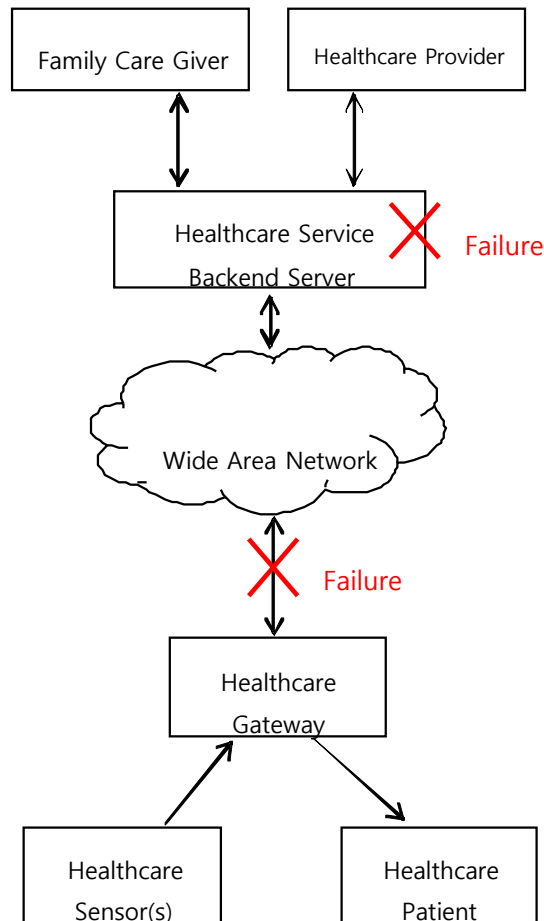


Figure 7-5 Example of failures in components of the M2M System for healthcare service

### 7.1.8 Post-conditions

**1. Normal flow**

Sensor data is stored in a database associated with the backend server. Healthcare provider and care-giver observe data to ascertain status of patient's health.

**2. Alternative Flow 1**

Data is buffered and transmitted when the network constraints or policy constraints or device energy minimization constraints allow the transmission of delay-tolerant data.

**3. Alternative Flow 2**

Patient takes measurement and sends data to backend server.

**4. Alternative Flow 3**

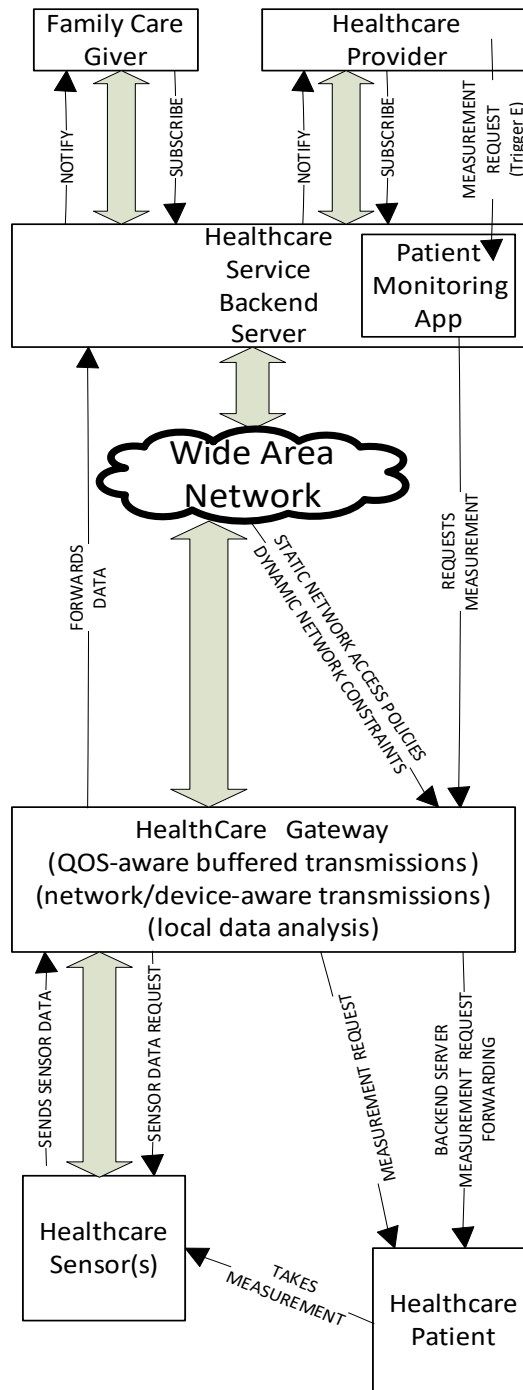
Local data analysis with indication of abnormal condition results in an alert message sent to the health care provider and optionally to the patient.

**5. Alternative Flow 4**

Components of the healthcare system that are not in failure continue their normal operations.

### 7.1.9 High Level Illustration

Figure 7-6 summarizes the overall description of this use-case. All the flows and connectivity should be self-explanatory based on the discussions in the previous clauses.



993  
994 **Figure 7-6 Healthcare Gateway High Level Illustration**

995 **7.1.10 Potential Requirements**

996 **Rationale**

997 This use case sets out from the presence of a gateway between one or more healthcare sensor(s) and a backend  
998 server. Even though the use case is assuming a cellular gateway, this restriction is not needed in general.

999 **Resulting requirement:**

- 1000 1. The M2M system shall be capable of supporting gateway nodes that are capable of transporting sensor  
1001 measurements to back end servers.  
1002

1003 **Rationale**

1004 Sensors can measure patient data with or without patient initiation. Therefore, new measurement data may  
1005 become available at any time.

1006 **Resulting requirement:**

- 1007 2. Whenever a healthcare sensor has measurement data available, it shall be possible for the sensor to  
1008 send a request to the local healthcare gateway to transport new measurement data to the backend  
1009 server.  
1010

1011 **Rationale**

1012 Incoming requests from the healthcare sensor to the healthcare gateway may not result in immediate  
1013 forwarding of the data to the backend server if any of the following is applicable: Dynamically changing  
1014 cellular network availability (coverage); cellular network utilization constraints (policies); device energy  
1015 consumption or memory constraints or mobility, and data delay tolerance/QoS information. In some cases, the  
1016 delay tolerance may be very low (implying requiring immediate transport) whereas in other cases, the delay  
1017 tolerance can be significant. In some other variants where real-time delivery or near-real-time delivery is of  
1018 interest, then real-time latency and bandwidth QoS requirements become significant. More than one healthcare  
1019 sensor may provide data at the same time, so that the healthcare gateway will need to process one or more  
1020 concurrent data streams. Event categories associated with the data to be transported (such as alert=high  
1021 priority) can also be relevant for determining when the connection needs to be triggered.  
1022

1023 **Resulting requirements:**

- 1024 3. The local healthcare gateway needs to be capable to buffer incoming requests from the healthcare  
1025 sensor for transporting data to the backend server and support forwarding them at a later time – which  
1026 could potentially be a very long time in the order of hours, days or even more – depending on cellular  
1027 network availability, cellular network utilization policies, device constraints  
1028 4. The local healthcare gateway needs to be capable of accepting parameters with incoming requests  
1029 from the healthcare sensor source which define a QoS policy for initiating the delivery of the sensor  
1030 measurements or parameters for categorizing sensor measurements into different levels of  
1031 priority/QoS.  
1032 5. The local healthcare gateway needs to be able to concurrently process multiple streams of data from  
1033 different sources with awareness for the stream processing requirements for each of the streams. The  
1034 local healthcare gateway needs to address the QoS policy of one or more concurrent streams while  
1035 taking into account network constraints such as available link performance and network cost. The  
1036 local healthcare gateway needs to adapt to dynamic variations in the available link performance or  
1037 network communication cost or network availability to deliver one or more data streams concurrently  
1038 6. The local healthcare gateway needs to be capable of receiving policies which express cellular network  
1039 utilization constraints and which shall govern the decision making in the gateway when initiating  
1040 connectivity over cellular networks.  
1041 7. The local healthcare gateway needs to be capable to trigger connections to the cellular network in line  
1042 with the parameters given by the request to transport data and in line with configured policies  
1043 regarding utilization of the cellular network  
1044

1045 **Rationale**

1046 A subscription and notification mechanism was described in this use case. Only authenticated and authorized  
1047 users (e.g. care-giver, relatives, and doctors) shall be able to subscribe to healthcare sensor measurement data  
1048 and get notifications and access to the measured data. These authenticated and authorized stakeholders are  
1049 typically using applications that use the M2M system to access the measured data.  
1050

1051 **Resulting requirement:**

- 1052 8. The M2M system shall be capable of supporting a mechanism to allow applications (residing on the  
1053 local gateway, on the backend server or on the sensor itself) to subscribe to data of interest and get  
1054 notifications on changes or availability of that data.  
1055 9. The M2M system needs to be able to allow access to data that is being transported or buffered only to  
1056 authenticated and authorized applications  
1057

1058 **Rationale**

1059 The use case also describes a flow in which the backend server could initiate an action on the local healthcare  
1060 gateway.  
1061

1062 **Resulting requirements:**

- 1063 10. The M2M system shall support transport of data from the backend server to the cellular healthcare  
1064 gateway.  
1065 11. The M2M system shall support of triggering a cellular connection to the local healthcare gateway in  
1066 case the gateway supports such functionality.  
1067

1068 **Rationale**

1069 Different subscribers may be interested in different information so that each subscriber may want to get  
1070 notified only for events of interest to that subscriber:  
1071

1072 **Resulting requirements:**

- 1068 12. Subscriber-specific filters can be set up at the healthcare service enterprise backend server so that each  
1069 subscriber can be notified only when information/events relevant to the subscriber are available/occur.  
1070

#### 1071 **Rationale**

1072 The M2M healthcare gateway device can be without an active network connection because it is in a sleep  
1073 mode of operation to save energy and/or because it is trying to save radio/network resources. A patient  
1074 monitoring app may be desirous of communicating with the gateway device when the gateway device is in this  
1075 sleep mode of operation.  
1076

#### 1077 **Resulting requirements:**

- 1078 13. The M2M system shall be able to support a wakeup trigger (aka "shoulder-tap") mechanism (such as  
1079 using SMS or alternate mechanisms) to wake up the gateway. The gateway can subsequently establish  
1080 a network connection and query the enterprise backend server for additional information, and the  
1081 enterprise backend server may then respond with adequate information to enable further processing of  
1082 its request.  
1083 14. When some of the components of M2M System are not available (e.g. WAN connection lost), the  
1084 M2M System shall be able to support the normal operation of components of the M2M System that  
1085 are available.  
1086 15. When some of the components of M2M System are not available (e.g. WAN connection lost), the  
1087 M2M System shall be able to support the confidentiality and the integrity of data between authorized  
1088 components of the M2M System that are available.

## 1089 7.2 Wellness Services

### 1090 7.2.1 Description

1091 This use case introduces several services based on wellness data collected by wellness sensor devices via  
1092 mobile device such as smartphones and tablets which is regarded as M2M gateway.  
1093 Some wellness sensor devices are equipped with M2M area network module and measure individual wellness  
1094 data. The mobile device connects to the wellness sensor devices by using the M2M area network technology,  
1095 collecting and sending the wellness data to application server.  
1096 It is important to consider that mobile device as M2M gateway has mobility. For instance, there are  
1097 possibilities for a mobile device to simultaneously connect to many wearable wellness sensor devices, and to  
1098 connect newly to wellness sensor devices which have never connected previously at the location of outside.  
1099 This use case illustrates potential requirements from the use case of wellness services utilizing mobile device.

### 1100 7.2.2 Source

1101 oneM2M-REQ-2013-0167R03 Use Case on Wellness Services

### 1102 7.2.3 Actors

- 1103 • M2M Device: wellness sensor device is blood pressure sensor, heart rate sensor and weight scale, for  
1104 example. It can measure wellness data of users, may be multi-vendor, and equipped with several kind of  
1105 communication protocol.  
1106 • M2M Area Network: network which connects between M2M device and M2M gateway.  
1107 • M2M Gateway: mobile device (e.g. a smart phone) which can receive wellness data from wellness sensor  
1108 devices and communicate with application servers.  
1109 • Mobile Network: network which has functions to communicate wellness data and control message between  
1110 M2M gateway and M2M service platform.  
1111 • M2M Service Platform: platform where management server is located and which is used by the Application  
1112 Server to communicate with the M2M Gateway.  
1113 • Management Server: server which manages the gateway such as mobile device, and controls its configuration  
1114 such as installing/uninstalling applications.  
1115 • Application Server: server which serves the wellness services such as indicating the graph of wellness data  
1116 trend.

1117 Note: Definition of some words is in discussion. Therefore, the description of these actors may change.

## 7.2.4 Pre-conditions

- Wellness sensor devices are able to establish a connection to the mobile device in order to send wellness data to M2M Service Platform or Application Server.
- It is first time to associate the mobile device with the wellness sensor devices.

## 7.2.5 Triggers

New wellness sensor devices such as weight scale are detected by mobile device. User tries to associate the detected devices. Examples are below:

- User buys several kind of wearable wellness sensor devices such as blood pressure sensor, heart rate sensor. In order to start monitoring vital data using these sensors, User tries setting of these devices simultaneously. Note that please refer to [i.4] ETSI TR 102 732 “Use cases of M2M applications for eHealth”. (Normal Flow)
- User buys wellness sensor devices such as weight scale, and newly deploys them at User’s house to check the wellness status daily. (Normal Flow)
- User goes to a fitness centre to do exercise and checks the effect by utilizing equipment which is owned by fitness centre and has never connected to User’s mobile device. (Alternative Flow 1)

## 7.2.6 Normal Flow

Usually wellness sensor devices are bought by Users. These devices are deployed in User’s house, or are worn with User.

1. The mobile device detects new wellness sensor devices and tries to connect to it under User’s permission to connect (pairing between sensor device and mobile device).
2. The mobile device has established a connection to the wellness sensor device, and then the mobile device receives additional information of the wellness sensor device (e.g. type of device, service certificates of the device, required application software ...).
3. The mobile device is provided with the appropriate application software from the Management Server and is appropriately configured by the Management Server.
4. When the User measures the data by using wellness sensor device, the mobile device collects the data and sends it to the Application Server.

## 7.2.7 Alternative Flow

### Alternative Flow 1

1. As indicated in the Normal Flow, usually the wellness service collects the data from wellness sensor devices which the User owns.
2. When the mobile device is brought outside, there is an opportunity to connect new wellness sensor devices (e.g. blood pressure which is set in fitness centre).
3. The mobile device detects new wellness sensor devices and tries to connect to them under User’s permission to connect.
4. The mobile device has established a connection to the wellness sensor device and then the mobile device receives additional information of the wellness sensor device (e.g. type of device, service certificates of the device, required application software ...).
5. The mobile device is provided with the appropriate application software and is appropriately configured by the Management Server.
6. When the User measures the data by using wellness sensor device, the mobile device collects the data and sends it to the Application Server.

### Alternative Flow 2

1. The wellness service may be an optional subscriber service to be charged. The User subscribes it and creates an account on the Application Server.
2. When the User utilizes the wellness service, at first the User needs to activate the service on the Application Server.
3. When the mobile device detects wellness sensor devices, it requests the Management Server to provide appropriate application software with configuration to the mobile device.
4. The Management Server checks with the Application Server if the User has subscribed to the service and activated it or not.
5. And then, if the User is not subscribed to the service or has not activated it, the Management Server does not provide any application software.

### Alternative Flow 3

After the User has collected the data, the User is able to disconnect the mobile device from the wellness sensor device and to de-activate the service.

1. If the User brings the mobile device out of the range of M2M Area Network, the mobile device disconnects the wellness sensor device automatically.
2. The User is also able to disconnect these devices by operating settings of the mobile device or by waiting for a while until the wellness sensor device disconnect by itself.
3. The User is also able to cancel the optional service. The User applies the cancellation to the Application Server. After the Application Server accepts the cancellation, the Management Server checks with the Application Server. The Management Server confirms the cancellation, it makes application software de-activate and/or remove from the mobile device.

## 7.2.8 Post-conditions

- Measured wellness data are stored in the M2M Service Platform or the Application Server.
- User is able to access to the Application Server and explore the graph of the wellness data trend.

## 7.2.9 High Level Illustration

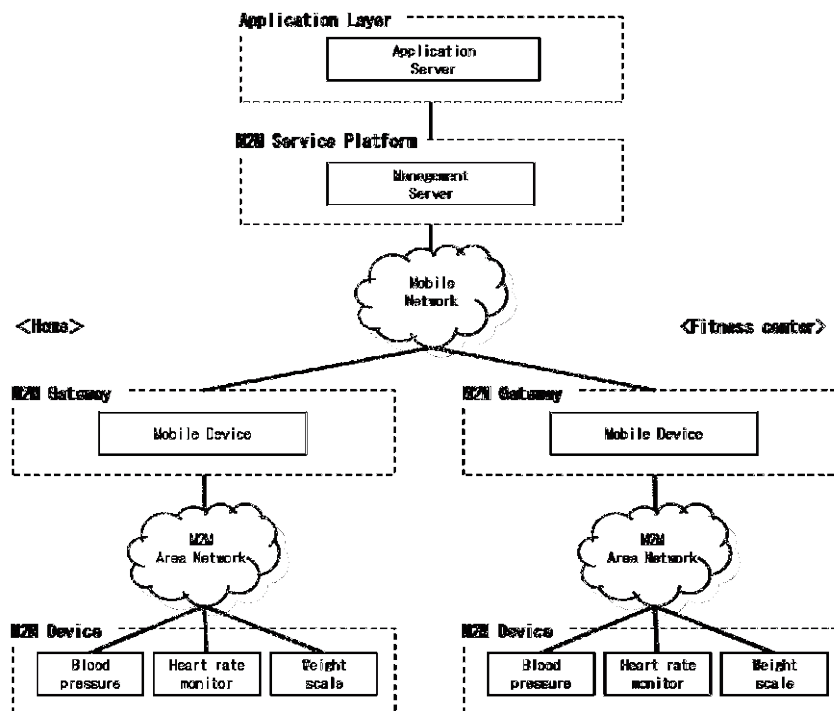


Figure 7-7 Wellness Service High Level Illustration

## 7.2.10 Potential Requirements

1. M2M Gateway SHALL be able to detect device that can be newly installed (paired with the M2M Gateway).
2. Upon detection of a new device the M2M Gateway SHALL be able to be provisioned by the M2M Service Platform with an appropriate configuration which is required to handle the detected device.
3. The M2M Service Platform SHALL be able to provide an authenticated and authorized application in the M2M Gateway with appropriate configuration data.

## 7.3 Secure remote patient care and monitoring

### 7.3.1 Description

E-health applications, that provide the capability for remote monitoring and care, eliminate the need for frequent office or home visits by care givers, provide great cost-saving and convenience as well as improvements. “Chronic disease management” and “aging independently” are among the most prominent use cases of remote patient monitoring applications. More details of the actors and their relationships for these use cases are mentioned in details in an ETSI document [i.4] and are not covered here. Instead this contribution provides an analysis of specific security issues pertaining to handling of electronic health records (EHR) to provide a set of requirements in the context of oneM2M requirement definition work.

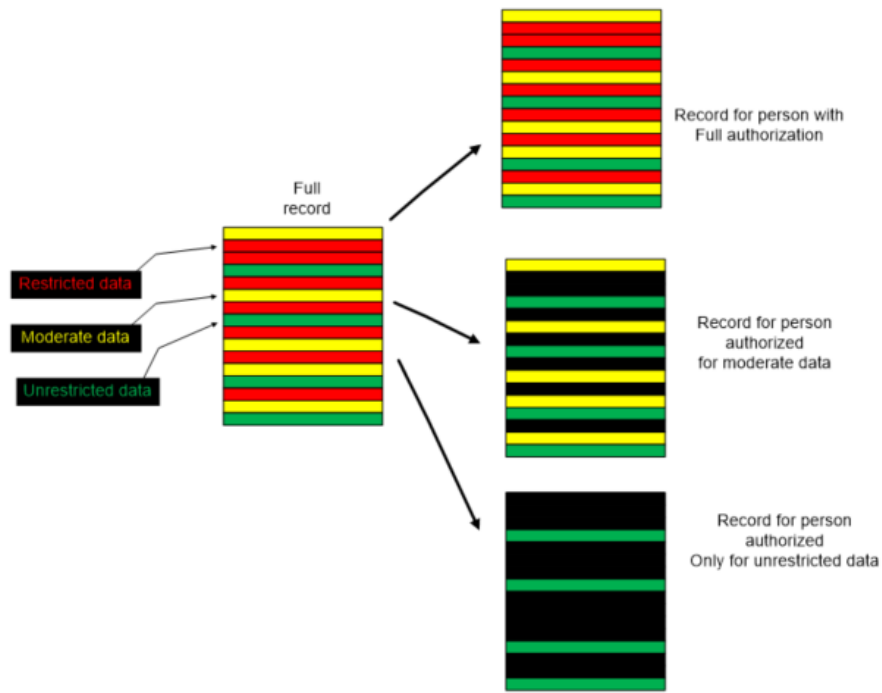
Remote patient monitoring applications allow measurements from various medical and non-medical devices in the patient’s environment to be read and analysed remotely. Alarming results can automatically trigger notifications for emergency responders, when life-threatening conditions arise. On the other hand, trigger notifications can be created for care givers or family members when less severe anomalies are detected. Dosage changes can also be administered based on remote commands, when needed.

In many cases, the know-how about the details of the underlying communications network and data management may be outsourced by the medical community to e-health application/ solution provider. The e-health solution provider may in turn refer to M2M service providers to provide services such as connectivity, device management. The M2M service provider may intend to deploy a service platform that serves a variety of M2M applications (other than e-health solution provider). To that end, the M2M service provider may seek to deploy optimizations on network utilization, device battery or user convenience features such as ability of using web services to reach application data from a generic web browser. The M2M service provider may try to provide uniform application programming interfaces (APIs) for all those solution providers to reach its service platform in a common way. From the standpoint of the M2M application, the application data layer rides on top a service layer provided by this service platform. By providing the service platform and its APIs, the M2M SP facilitates development and integration of applications with the data management and communication facilities that are common for all applications.

As part of providing connectivity services, the M2M service provider may also provide secure sessions for transfer of data for the solution providers that it serves. In many jurisdictions around the world, privacy of patient healthcare data is tightly regulated and breaches are penalized with hefty fines. This means the e-health application provider may not be able to directly rely on the security provided by the M2M service provider links/sessions and instead implement end to end security at application layer. This puts additional challenges on the M2M service platform, since it needs to provide its optimizations on encrypted data.

One particular issue with e-health is that not only the data is encrypted, but it may also contain data at different sensitivity levels, not all of which appropriate to each user. For instance in the US the Health Insurance Portability and Accountability Act (HIPAA) regulates the use and disclosure of protected health information. Different actors within a healthcare scenario may have different levels of authorizations for accessing the data within the health records, so the information system must take care to present the health data to each user according to the level of authorization for that user. A process, common to address this issue is redaction. This means that one starts with a document that originally includes data of all sensitivity levels and then removes any piece of information that has a higher sensitivity level than the pre-determined redaction level (RL). The end result is a redacted version of the initial document that can be presented to a person/entity that has the matching authorization level (AL). Persons with lower AL are not authorized to view this particular version of document. The redaction engine can produce multiple versions of the initial records, where each version corresponds to one redaction level (RL) including material at specific sensitivity level (and lower).



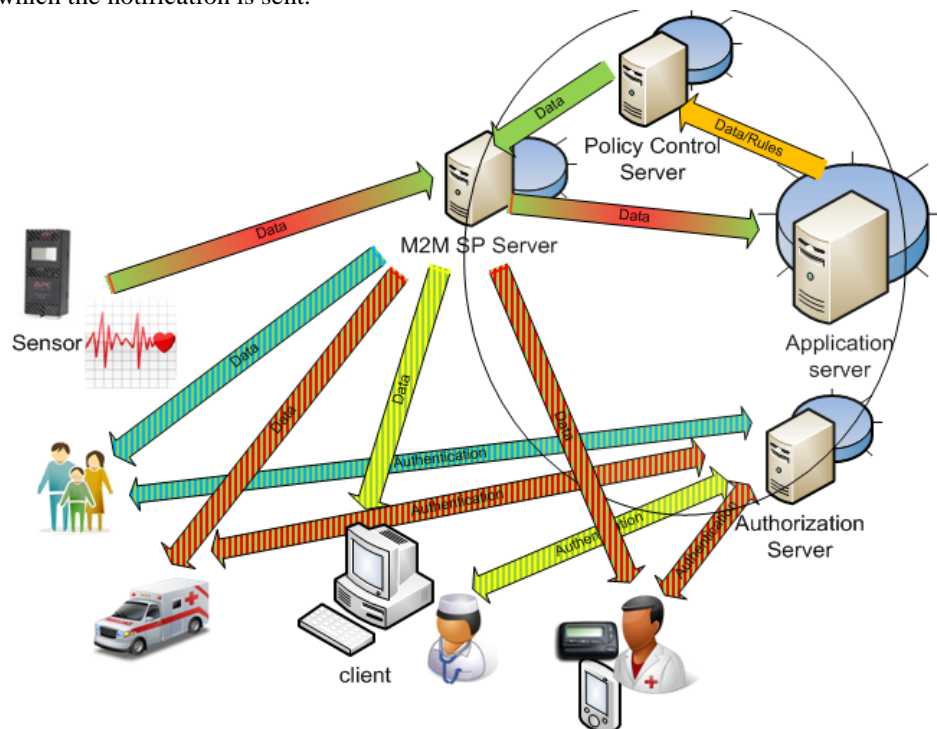


**Figure 7-8 – An illustration of a process with 2 levels of redaction. Black colour indicates a data field that is masked from an unauthorized user.**

Care must be taken to ensure that only authorized users have access to data. Therefore, the system must match the redaction level (RL) of data with the authorization level (AL) and present the proper version of the record for each actor.

The redaction engine may reside at a policy control server or at the application server operated by the M2M application service provider. The policy server may also hold policies on which users get which authorization level (AL), while an authorization server may be in charge of authenticating each user and assigning her the proper AL.

In a system relying on notifications based on prior subscriptions, data must be examined first to determine which subscribers should receive notifications and then only those subscribers should be capable to retrieve the data about which the notification is sent.



1260 **Figure 7-9 An e-Health application service capable of monitoring remote sensor devices and producing**  
1261 **notifications and data to health care personnel based on their authorization level.**

## 1262 7.3.2 Source

1263 oneM2M-REQ-2013-0227R02 e-Health application security use case

## 1264 7.3.3 Actors

- 1265 • Patients using sensor (medical status measurement) devices
- 1266 • E-Health application service providers, providing sensor devices and operating remote patient monitoring,  
1267 care and notification services
- 1268 • Care givers (e.g. nurses, doctors, homecare assistants, emergency responders) and other administrative users  
1269 with authorization to access healthcare data (e.g. insurance providers, billing personnel). We also refer to  
1270 these entities as “participants in the healthcare episode” in some occasions.
- 1271 • M2M service providers, network operators, providing connectivity services for the patients, e-health  
1272 application providers and care givers.
- 1273

## 1274 7.3.4 Pre-conditions

- 1275 • A categorization rule set, that is able to categorize various entries within a medical record according to the  
1276 sensitivity levels and label them accordingly, must exist.
- 1277 • A redaction engine that is able to examine the raw medical record and produce different versions of the  
1278 record at different redaction levels (RL) with only data that is at or below a sensitivity level.
- 1279 • A policy engine that is able to examine medical records and determine level of criticality (applicable to one  
1280 of the flows described).
- 1281 • A set of authorization policies that describe what authorization level (AL) is required to be able to access data  
1282 at each redaction level (RL).
- 1283 • An authorization engine/server that interacts with each user of the e-health application to verify their claimed  
1284 AL, for example the server may perform an authentication function with the user.
- 1285 • The e-health application server that is capable of interacting with the authorization server to check the AL of  
1286 each user to determine the user’s RL before serving data at the requested (or appropriate) RL to that user.
- 1287

## 1288 7.3.5 Triggers

- 1289 • Creation of new measurement data by a remote medical device.
- 1290 • Analysis of received measurement data at application servers, and determination of need for redaction, or  
1291 creation of alarms and notifications, etc.
- 1292 • Requests from participants in a health care episode (caregivers) for sensitive medical records.
- 1293 • Arrival of new participants (new doctors, etc.) in the health care episode
- 1294

## 1295 7.3.6 Normal Flow

1296 In the main flow a remote medical device performs a measurement and sends it to an e-health application  
1297 provider’s (AP) application server, which in turn processes the data and notifies the appropriate actors  
1298 regarding the condition of the patient.

1299 The AP provides an application client to be installed on the device, and the application servers that interact  
1300 with all the application clients. Both the application client and application server use the data management and  
1301 communication facilities within the service layer exposed through the service layer APIs.

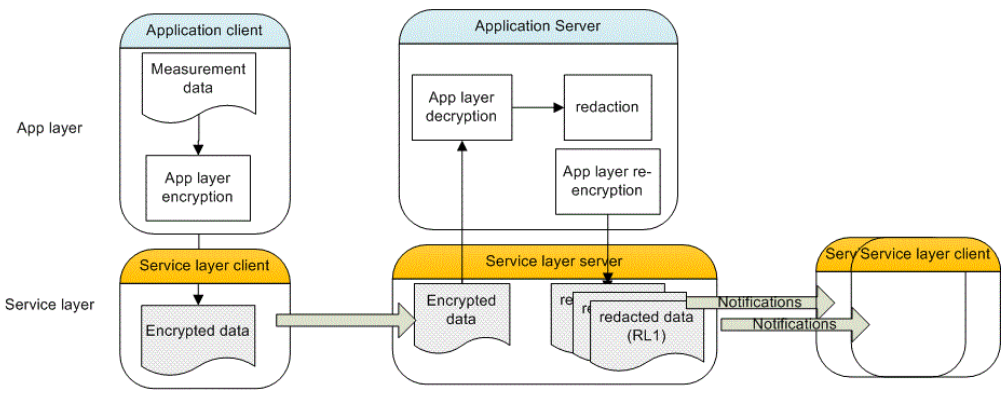
1302 This flow could be as follows:

- 1303 • The sensor on the medical device performs a measurement and reports it to the application client on  
1304 the device.
- 1305 • The application client (e.g. an e-health application) uses the service layer API to reach the service  
1306 layer (provided by M2M service provider) within the device to transfer data to the application server.  
1307 When application level data privacy is required, the application client on the device must encrypt the  
1308 sensor data before passing the data to the service layer. Since the data must be kept private from  
1309 service layer function, the encryption keys and engine used by the application client must be kept  
1310 within a secure environment that is out of reach of the M2M service provider. This may require a set  
1311

1312  
1313  
1314  
1315  
1316  
1317  
1318  
1319  
1320  
1321  
1322  
1323  
1324  
1325  
1326  
1327  
1328  
1329  
1330  
1331  
1332  
1333  
1334  
1335  
1336  
1337  
1338  
1339  
1340  
1341  
1342

of secure APIs to reach the application’s secure environment. It may however be more convenient that these APIs are bundled with the secure APIs used to reach keys/ environment that secures the service layer, so that each application only deals with one set of APIs.

- The service layer (provided by M2M service provider) passes the data from the device to the M2M service provider servers.
- The M2M service layer at the server side passes the data to the e-health application server.
- At this point, the application needs to prepare to notify any interested parties (caregivers) that have subscribed to receive notifications regarding the status or data received about a patient. However, when application data is encrypted and redaction is to applied, more intelligence must be applied regarding who is authorized to receive a notification regarding status update. This may be done as follows:
  - After the e-health application server receives the data from M2M SP server, it decrypts the data, analyses and performs redactions based on application policies (possibly with help of policy servers). This produces multiple versions of the initial data (one at each redaction level). The application server then re-encrypts each redacted version. Each encrypted version needs to be tagged based on the redaction level (RL) it contains and possibly the authorization level (AL) it requires for viewing.
  - The application server passes the tagged data (multiple files) to the M2M service provider server (the service layer server)
  - The M2M SP server will then sends a notification to each of the subscribers as long as their AL is at or above the level required to view any of the data just received. This means a separate authorization server may have initially performed an authorization of each user that requests to subscribe to data regarding each patient. The authorization would need to assess the identity of the user, her role and the claimed AL before registering the user for notifications. It is possible that the authorization server upon assertion of AL for each user provide the necessary decryption keys for receiving encrypted redacted data to the user’s device. In that case, the device that the user is using needs to be authenticated based on a verifiable identity (an identity that is bound to a tamper-proof identity within the secured environment). Alternatively, the decryption keys may be present within the user devices (e.g. specific USB stick!) through other means. In either case a mechanism must exist to release decryption keys stored with an authenticated device’s secure storage based on the user authorization and thus a binding of user and device authentications may be important.



1343  
1344  
1345  
1346  
1347

**Figure 7-10 Dealing with Redaction in an M2M system separating Application layer and Service layer. The Service layer functions are provided by M2M service provider, while application layer functions are provided by application provider.**

### 7.3.7 Alternative Flow

1349  
1350  
1351  
1352  
1353  
1354  
1355  
1356

**Alternative Flow No 1**

One alternative flow is when a user requests information regarding a patient without having previously subscribed for any notifications. The M2M SP server must first refer the user to the authorization server to assert the user’s authorization level (AL) before serving the user with a response.

**Alternative Flow No 2**

One alternative flow is when a user requests to provide instruction commands regarding a patient to a remote device. The service must make sure that the user has the proper AL to issue the command.

1357  
1358 **Alternative Flow No 3**

1359 One alternative flow is when users are categorized not based on authorization levels but based on the level of  
1360 their responsiveness. For instance, a life-critical event must cause the emergency responders to receive  
1361 notifications and act very quickly, while a less critical event may only lead to a family member to be alerted.  
1362 The subscription/ notification system should provide this level of granularity, i.e. information can be tagged  
1363 based on criticality level. There must also be a policy engine that categorize the data based on its criticality  
1364 level (CL).

1365 **7.3.8 Post-conditions**

1366 **Normal flow**

1367 Multiple versions of patient record exist for multiple redaction levels at the M2M service provider servers.  
1368 Each user can pull the version corresponding to her AL after she has been notified about presence of new data.  
1369 The server can serve the data based on its RL tagging or AL tagging.

1370 **Alternative Flow No 3**

1371 Data is tagged with criticality level and served to each user according to their level of responsiveness.  
1372

1373 **7.3.9 High Level Illustration**

1374 Not provided

1375 **7.3.10 Potential requirements**

- 1376 1. The M2M system shall support M2M applications with establishing a security context for protecting  
1377 the privacy of application data from the underlying M2M service.  
1378

1379 This means support of synchronous exchanges required by identification/ authentication/ or other security  
1380 algorithms for establishment of security associations (keys, parameters, algorithms) for end-to-end encryption  
1381 and integrity protection of data. Furthermore, any exchanges for establishing the M2M application security  
1382 context can use the security context at underlying layers (e.g. M2M service layer) to protect the exchanges (as  
1383 another layer of security), but the M2M application security context, once established, would be invisible to  
1384 the M2M system.  
1385

- 1386 2. The M2M system must support mechanisms for binding identities used at service layer and/or  
1387 application layer to the tamper proof identities that are available within the device secured  
1388 Environment.  
1389

1390 Anchoring higher layer identities to a low level identity (e.g. identities that are protected at the hardware or  
1391 firmware level) is needed to be able to securely verify claimed identities during device authentication  
1392 processes at various levels. Also APIs providing lower layer identities to application layer for the purpose of  
1393 binding application layer identities and lower layer identities.  
1394

- 1395 3. M2M devices and M2M system shall support provisioning of application specific parameters and  
1396 credentials prior and/or after field deployment, while preserving the privacy of provisioned material  
1397 from M2M system if needed.  
1398

1399 This means the M2M devices must support identities and credentials that are independent of the M2M system  
1400 provider credentials and could be used for delivery of application specific parameters/credentials.

- 1401 4. When M2M application data security is independent of M2M system, the Secured Environment  
1402 within devices or infrastructure entities shall provide separation between the secured environments for  
1403 each application and the secured environment for M2M service layer.  
1404 5. The secure environment described in requirement above shall provide both secure storage (for keys,  
1405 sensitive material) and secure execution engine (for algorithms and protocols) for security functions  
1406 for each application or service layer.  
1407 6. The security functions provided by the Secured Environment should be exposed to both M2M service  
1408 layer and M2M applications through a set of common APIs that allow use of Secured Environment of  
1409 each of M2M service layer and M2M applications in a uniform fashion.  
1410 7. The M2M service layer must be able to perform authorization before serving users with sensitive data.  
1411 8. The authorization process should support more than two authorization levels and the service layer  
1412 must be able to accommodate response/ notifications to the users based on their level of authorization.

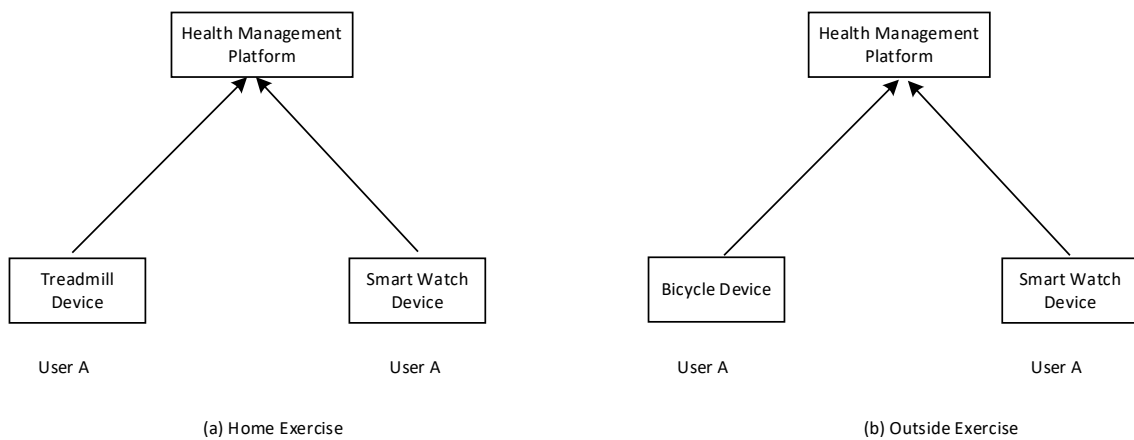
9. The M2M service layer must accommodate tagging of opaque application data for various purposes, such as urgency levels, authorization/redaction levels, etc.
10. There must be a mechanism to allow the M2M application or service layer to bind user credentials/authorizations to device credentials, such that credentials within the device can be used for security purposes during or after a user is authenticated/ authorized.
11. The M2M service layer must be able to accommodate delay requirements for the application based on the tagging applied to the application data. For instance, data that is marked critical must create notifications for first-level responders.
12. Any software client, especially those performing security functions (e.g. authentication clients) must be integrity protected (signed) and verified after device power up/reset or before launch. Widely deployed standards such PKCS#7 or CMS should be used for code signing.

## 7.4 Use case for information correlation

### 7.4.1 Description

Different devices have different functions, but these functions may produce related information. For example, a smart watch can be used to monitor heart rate, number of steps etc.; meanwhile, a treadmill/bicycle can be used to monitor speed, distance, and calories burned. When these devices refer to the same person, the data produced by these devices are highly related, since the data is all about the health of the person.

At the same time, the relationship of different devices is dynamic. For example, when doing home exercise, the smart watch and treadmill are related. Similarly, when doing outside exercise, the smart watch and bicycle are related.



**Figure 7-11 (a) Home exercise and (b) outside exercise use cases for information correlation**

### 7.4.2 Source

REQ-2017-0073R02 Use case for information correlation

### 7.4.3 Actors

- Smart Watch Device: has function to monitor the heart rate, number of steps of the End Users.
- Treadmill Device: has function to monitor the speed, distance, calories burned of the End Users.
- Bicycle Device: has function to monitor the speed, distance, calories burned of the End Users.

- 1447 • Healthcare Management Platform: manages the healthcare related devices and stores the healthcare related  
1448 information.
- 1449 • End User: the user of the healthcare related devices.  
1450

### 1451 7.4.4 Pre-conditions

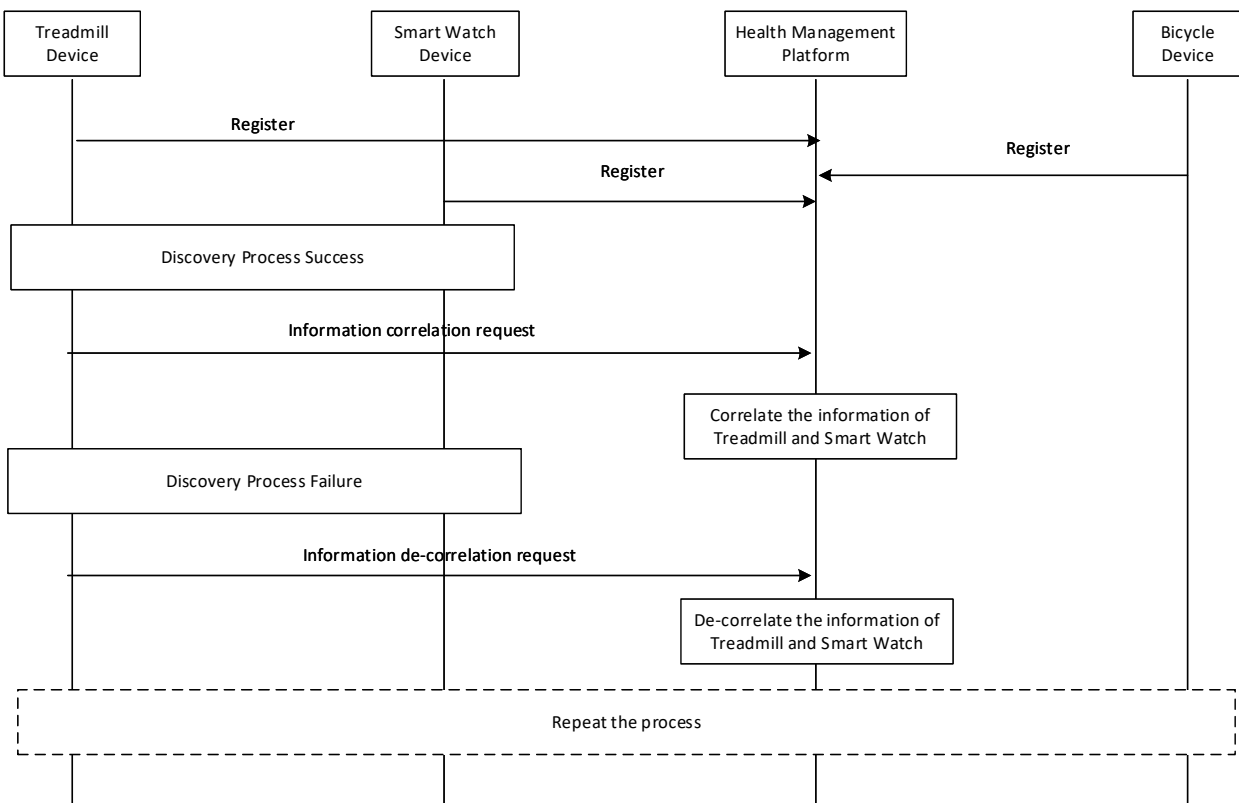
1452 Smart Watch Device has the capability to discovery the Treadmill Device and Bicycle device, for example,  
1453 using the NFC technology to discover the Treadmill device and Bicycle device.  
1454

### 1455 7.4.5 Triggers

1456 Not applicable  
1457

### 1458 7.4.6 Normal Flow

1459  
1460



1461  
1462  
1463  
1464

**Figure 7-12 Information correlation normal flow**

1. Smart Watch Device, Treadmill Device, Bicycle Device register to Healthcare Management Platform;

- 1465 2. During home exercise time, User A uses the Smart Watch Device to find the Treadmill Device;
- 1466 3. Smart Watch Device initiates an information correlation request to the Healthcare Management platform;
- 1467 4. Healthcare Management platform correlates the information of the Smart Watch Device and Treadmill
- 1468 Device;
- 1469 5. User A leaves the treadmill device and can't find the treadmill device;
- 1470 6. The Smart Watch Device initiates an information de-correlation request to the Healthcare Management
- 1471 platform;
- 1472 7. Healthcare Management platform de-correlated the information of the Smart Watch Device and Treadmill
- 1473 Device.
- 1474 8. During outside exercise time, User A uses the Smart Watch Device to find the Bicycle Device;
- 1475 9. Smart Watch Device initiates an information correlation request to the Healthcare Management platform;
- 1476 10. Healthcare Management platform correlates the information of the Smart Watch Device and Bicycle;
- 1477 11. User A leaves the bicycle device and can't find the bicycle device;
- 1478 12. The Smart Watch initiates an information de-correlation request to the Healthcare Management platform;
- 1479 13. Healthcare Management platform de-correlated the information of the Smart Watch Device and Bicycle
- 1480 Device.

1481

#### 1482 7.4.7 Alternative flow

1483 Not applicable

#### 1484 7.4.8 Post-conditions

1485 Not applicable

#### 1486 7.4.9 High Level Illustration

1487 Not applicable

#### 1488 7.4.10 Potential requirements

- 1489 1. The oneM2M system shall support the correlation of information from different entities.
- 1490 2. The oneM2M system shall support de-correlation of information from different entities.

1491

1492

---

## 1493 8 Public Services Use Cases

### 1494 8.1 Street Light Automation

#### 1495 8.1.1 Description

1496 Street Light Automation can be considered as part of the City Automation (ETSI classifier) vertical industry

1497 segment – and related to others e.g. Energy, Intelligent Transportation Systems, etc.

1498 Industry segment organisations: none known

1499 Industry segment standards: none known

1500 Deployed: with varying functionality, in multiple countries

1501

1502 Street Light Automation Goals

- 1503
- Improve public safety
- 1504
- Reduced energy consumption / CO2 emissions
- 1505
- Reduce maintenance activity
- 1506

1507

#### Methods

- 1508
- Sensing and control
- 1509
- Communications
- 1510
- Analytics
- 1511

1512 A street light automation service provider, provides services to control the luminosity of each street light  
1513 dependent upon (resulting in 10 sub-use cases):

1514 Local (street level)

- 1515
1. Light sensors
- 1516
2. Power quality sensors
- 1517
3. Proximity sensors (civilian or emergency vehicles, pedestrians)

1518 Street light automation service provider operation centre

- 1519
4. Policies (regulatory & contractual)
- 1520
5. Ambient light analytics (sunrise/sunset, weather, moonlight, etc.)
- 1521
6. Predictive analytics (lights parts of streets predicted to be used, etc.)

1522 Communications received from other service providers

- 1523
7. Traffic light service (emergency vehicle priority)
- 1524
8. Emergency services (vehicle routing, police action, etc.)
- 1525
9. Road maintenance service (closures and/or diversions)
- 1526
10. Electricity service (power overload)

1527

## 8.1.2 Source

1528 oneM2M-REQ-2012-0036R07 Proposed Use Case Street Light Automation

1529 *Note:* From public document research: “Street Light Control” use case identified in [i.5] ETSI TR 102 897  
1530

1531

## 8.1.3 Actors

- 1532
- Street light automation application service provider, has the aim is to adjust street light luminosity.
- 1533
- Street light devices have the aim is to sense, report, execute local and remote policies, illuminate street.
- 1534
- Traffic light application service provider, has the aim is to enhance their emergency vehicle service using  
1535 street lighting.
- 1536
- Emergency services application services provider, have the aim is to brightly illuminate police action areas  
1537 and brightly illuminate planned path of emergency vehicles.
- 1538
- Road maintenance application service provider, has the aim is to obtain extra street light signalling near  
1539 closed roads.
- 1540
- Electricity application service provider, has the aim is to have electricity consumers reduce their load when  
1541 an overload is declared.

1542

## 8.1.4 Pre-conditions

1543 See sub-case flows.

1544

## 8.1.5 Triggers

1545 See sub-case flows.

1546

## 8.1.6 Normal Flow

1547 1. **Sub use case 1** - Local: Light sensors

1548 **Summary:** (no atomic action steps)

1549 **Trigger:** Detected light level moves below/above threshold

1550 **Action:** Increase/decrease luminosity in a set of street lights

1551 **Detailed flow** (no confirmation, etc. – actors in “quotes”, system under study in italics)

1552 a. “Street lights” message the Street light system that street light sensors have detected light level  
1553 movement below/above threshold.

1554 b. Street light system informs the “street light operation centre” with the street light sensor information.



- c. “Street light operation centre” messages the Street light system with a street light control message to increase/decrease luminosity according to “street light operation centre” policy.
- d. Street light system messages the “street lights” with a street light control message to increase/decrease luminosity according to “street light operation centre” policy.
- e. Optionally (normal case), if “street lights” receive a control command from the Street light system within some time, then, “street lights” increase/decrease luminosity in a set of street lights according to “street light operation centre” policy.
- f. Optionally (alternative case), if “street lights” do not receive a control command from the Street light system within some time, then, “street lights” increase/decrease luminosity in a set of street lights, according to local policy.

Note that the terminology “policy” refers to a set of rules which may be dependent upon variables output from analytics algorithms.

## 2. Sub use case 2 - Local: Light sensors

**Local:** Power quality sensors

**Summary:** (no atomic action steps)

**Trigger:** Detected input voltage level moves above/below threshold

**Action 1:** Send alert message to electricity service provider

**Action 2:** Decrease/increase energy applied to a set of street lights

**Detailed flow** (no confirmation, etc. – actors in “quotes”, system under study in italics)

- a. “Street lights” message the Street light system that street light power sensors have detected input voltage level movement above/below threshold
- b. Street light system informs the “street light operation centre” with the street light sensor information
- c. “Street light operation centre” messages the Street light system with an alert message to “electricity service provider” according to “street light operation centre” policy.
- d. Street light system informs “electricity service provider” of alert message.
- e. “Street light operation centre” messages the Street light system with a street light control message to increase/decrease luminosity according to “street light operation centre” policy.
- f. Optionally (normal case), if “street lights” receive a control command from the Street light system within some time, then, “street lights” increase/decrease luminosity in a set of street lights according to “street light operation centre” policy.
- g. Optionally (alternative case), if “street lights” do not receive a control command from the Street light system within some time, then, “street lights” increase/decrease luminosity in a set of street lights, according to local policy

## 3. Sub use case 3 - Local: proximity sensors (civilian or emergency vehicles, pedestrians)

**Summary:** (no atomic action steps)

**Trigger:** Civilian or emergency vehicle or pedestrian detected entering/leaving street section

**Action:** Increase/decrease luminosity in a set of street lights

**Detailed flow** (no confirmation, etc. – actors in “quotes”, system under study in italics)

- a. “Street lights” message the Street light system that street light power sensors have detected civilian or emergency vehicle or pedestrian detected entering/leaving street section.
- b. Street light system informs the “street light operation centre” with the street light sensor information.
- c. “Street light operation centre” messages the Street light system with a control message to increase/decrease luminosity according to “street light operation centre” policy.
- d. Street light system messages the “street lights” with a street light control message to increase/decrease luminosity according to “street light operation centre” policy.
- e. Optionally (normal case), if “street lights” receive a control command from the Street light system within some time, then “street lights” increase/decrease luminosity in a set of street lights according to “street light operation centre” policy.
- f. Optionally (alternative case), if “street lights” do not receive a control command from the Street light system within some time, then, “street lights” increase/decrease luminosity in a set of street lights, according to local policy.

## 4. Sub use case 4 – Operation Centre: Policies (regulatory & contractual)

**Summary:** (no atomic action steps)

**Trigger:** SLA non-conformity for low intensity imminent

**Action:** Increase luminosity in a set of street lights to keep within SLA

**Detailed flow** (no confirmation, etc. – actors in “quotes”, system under study in italics)

- a. The “street light operation centre” detects through analytics that an SLA regarding minimum street light intensity is in danger of not being met.

- 1617 b. “Street light operation centre” messages the Street light system with a control message to increase  
1618 luminosity according to “street light operation centre” policy.  
1619 c. Street light system messages the “street lights” with a street light control message to increase  
1620 luminosity according to “street light operation centre” policy.  
1621

1622 5. **Sub use case 5** - Operation centre: Ambient light analytics (sunrise/sunset, weather, moonlight)

1623 **Summary:** (no atomic action steps)

1624 **Trigger 5a:** A band of rain moves across an area of street lights

1625 **Action 5a:** Increase/decrease luminosity in a rolling set of street lights

1626 **Trigger 5b:** Sunrise/sunset is predicted to occur area in 30 minutes

1627 **Action 5b:** Decrease/increase luminosity in a rolling set of street lights

1628 **Detailed flow** (no confirmation, etc. – actors in “quotes”, system under study in italics)

- 1629 a. The “street light operation centre” detects through analytics that (5a) a band of rain is moving across  
1630 an area of street lights, or (5b) Sunrise/sunset is predicted to occur area in 30 minutes.  
1631 b. “Street light operation centre” messages the Street light system with a street light control message to  
1632 increase/decrease luminosity according to “street light operation centre” policy.  
1633 c. The Street light system messages the “street lights” to increase/decrease luminosity in a set of street  
1634 lights according to “street light operation centre” policy.  
1635

1636 6. **Sub use case 6** - Operation centre: Predictive analytics (lights parts of streets predicted to be used)

1637 **Summary:** (no atomic action steps)

1638 **Precondition:** Vehicle paths are tracked via proximity sensors and a route model is generated

1639 **Trigger:** A vehicle enters a street section which has 85% probability of taking the next left turn

1640 **Action:** Increase luminosity on current street section ahead and also on street on next left

1641 **Detailed flow** (no confirmation, etc. – actors in “quotes”, system under study in italics)

- 1642 a. “Street lights” message the Street light system that street light power sensors have detected civilian or  
1643 emergency vehicle entering street section  
1644 b. Street light system informs the “street light operation centre” with the street light sensor information  
1645 c. “Street light operation centre” messages the Street light system with a control message to  
1646 increase/decrease luminosity according to “street light operation centre” policy.  
1647 d. Street light system messages the “street lights” with a street light control message to increase/decrease  
1648 luminosity according to “street light operation centre” policy.  
1649

1650 7. **Sub use case 7** - From other service providers: Traffic light service input (emergency vehicle priority)

1651 **Summary:** (no atomic action steps)

1652 **Trigger:** An emergency vehicle is approaching a junction

1653 **Action:** Increase luminosity in street lights along streets leading away from junction

1654 **Detailed flow** (no confirmation, etc. – actors in “quotes”, system under study in italics)

- 1655 a. “Traffic light service provider” messages the Street light system that emergency vehicle approaching  
1656 street junction from certain direction.  
1657 b. Street light system informs the “street light operation centre” with the street junction information.  
1658 c. “Street light operation centre” messages the Street light system with a control message to increase  
1659 luminosity according to “street light operation centre” policy.  
1660 d. Street light system messages the “street lights” with a street light control message to increase  
1661 luminosity according to “street light operation centre” policy.  
1662

1663 8. **Sub use case 8** - From other service providers: Emergency services input (vehicle routing, police action)

1664 **Summary:** (no atomic action steps)

1665 **Trigger 8a:** An emergency vehicle route becomes active

1666 **Action 8a:** Increase luminosity in street lights along vehicle route

1667 **Trigger 8b:** An area is declared as having an active police action

1668 **Action 8b:** Increase luminosity in street lights within police action area

1669 **Detailed flow** (no confirmation, etc. – actors in “quotes”, system under study in italics)

- 1670 a. “Emergency services provider” messages the Street light system that (8a) emergency vehicle street  
1671 route is active, or (8b) an area is declared as having an active police action  
1672 b. Street light system informs the “street light operation centre” with the street junction information  
1673 c. “Street light operation centre” messages the Street light system with a control message to increase  
1674 luminosity according to “street light operation centre” policy.  
1675 d. Street light system messages the “street lights” with a street light control message to increase  
1676 luminosity according to “street light operation centre” policy.  
1677

1678 9. **Sub use case 9** - From other service providers: Road maintenance service input (closures and/or  
1679 diversions)

1680 **Summary:** (no atomic action steps)

1681 **Trigger 9a:** A road is closed

1682 **Action 9a:** Program a changing luminosity pattern in street lights near to closed road

1683 **Trigger 9b:** A route diversion is activated

1684 **Action 9b:** Program a changing luminosity pattern in street lights along the streets of the diversion

1685 **Detailed flow** (no confirmation, etc. – actors in “quotes”, system under study in italics)

- 1686 a. “Road Maintenance service provider” messages the Street light system that (9a) a road is closed, or  
1687 (9b) a route diversion is activated
- 1688 b. Street light system informs the “street light operation centre” with the road maintenance information
- 1689 c. “Street light operation centre” messages the Street light system with a control message to set lights to  
1690 changing luminosity pattern according to “street light operation centre” policy.
- 1691 d. Street light system messages the “street lights” with a street light control message to set lights to  
1692 changing luminosity pattern according to “street light operation centre” policy.

1693  
1694 10. **Sub use case 10** - From other service providers: Electricity service input (power overload)

1695 **Summary:** (no atomic action steps)

1696 **Trigger:** A power overload situation is declared

1697 **Action:** Decrease luminosity in a set of street lights

1698 **Detailed flow** (no confirmation, etc. – actors in “quotes”, system under study in italics)

- 1699 a. “Electricity service provider” messages the Street light system that (9a) that an overload condition  
1700 exists across some area.
- 1701 b. Street light system informs the “street light operation centre” with the overload condition information
- 1702 c. “Street light operation centre” messages the Street light system with a control message to decrease  
1703 luminosity according to “street light operation centre” policy.
- 1704 d. Street light system messages the “street lights” with a street light control message to decrease  
1705 luminosity according to “street light operation centre” policy.

1706

## 1707 8.1.7 Alternative Flow

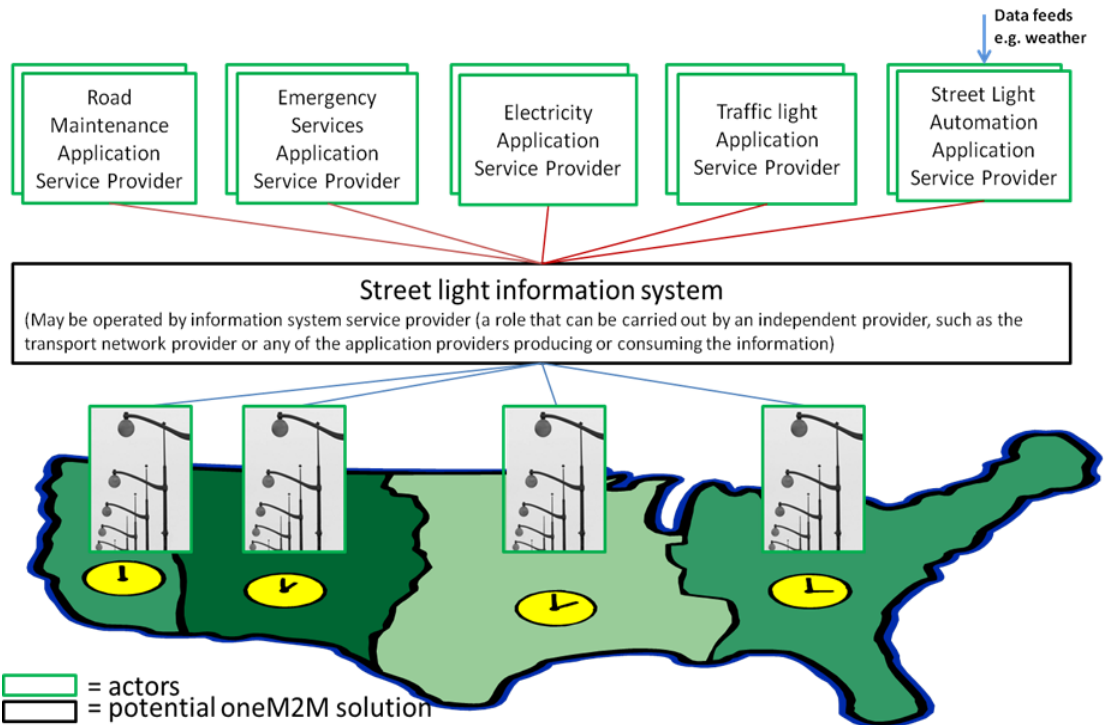
1708 In the case of loss of communications, street lights have local policies which they obey.

## 1709 8.1.8 Post-conditions

1710 Street light luminosity or luminosity pattern is adjusted as needed.

1711

### 8.1.9 High Level Illustration



1712

1713

1714

Figure 8-1 Street Light Automation High Level Illustration

### 8.1.10 Potential Requirements

1716

Generic (needed by two or more verticals or applications)

1717

1. The M2M solution shall support the ability to collect information from M2M devices.
- 1718 2. The M2M solution shall support the ability to deliver collected information from M2M devices to
- 1719 M2M applications.
- 1720 3. The M2M solution shall support control commands (for devices) from M2M applications.
- 1721 4. The M2M solution shall support control commands for groups of M2M devices.
- 1722 5. The M2M solution shall support the ability to receive device application software from M2M
- 1723 applications.
- 1724 6. The M2M solution shall support the ability to deliver device application software to M2M devices.
- 1725 7. The M2M solution shall provide mechanisms for information sharing, i.e. receiving information from
- 1726 M2M applications (information providing) to be consumed by other M2M applications (information
- 1727 consuming).
- 1728 8. The M2M solution shall provide charging mechanisms for information sharing among M2M
- 1729 applications.
- 1730 9. The M2M solution shall support the ability to provide an estimate of the time period from when a
- 1731 device sent a message to the M2M solution until when it responded with a message to the device.
- 1732 10. The M2M solution shall provide security context (authentication, encryption, integrity protection) for
- 1733 secure connection between entities. The security context shall include mechanisms and techniques on
- 1734 how to setup a security connection , and where the security connection information is stored and how
- 1735 to establish the secure connection
- 1736 11. The M2M service layer shall provide security mechanisms to facilitate the end to end security of
- 1737 M2M applications.
- 1738 12. The M2M service layer shall provide security mechanisms to avoid compromising the end to end
- 1739 security of M2M applications.

1740

Specific (to this vertical/use case)

1741

None

1742

Note that the terminology:

1743

- “Device application software” refers to application software that runs on a device including programs, patches, program data, configuration, etc.
- “M2M application” is any application that makes use of the M2M service layer - some form of prior agreement may be needed.

#### Security Considerations

- Attack vectors and example impacts:
  - By sending false reports of sensors to applications
  - Energy provider overdriving voltage
- By sending false control commands to devices
  - Blackout to obscure crime
- By blocking valid messages
  - Energy wastage

## 8.2 Devices, Virtual Devices and Things

### 8.2.1 Description

The municipality of a Smart City operates an Application Service that monitors traffic flow and switches traffic lights depending on traffic. This “traffic application” controls the traffic lights and a couple of surveillance cameras to observe traffic flow.

The traffic application makes several of the surveillance cameras discoverable in the M2M System and potentially allows access to the data (the video streams) of these cameras. The surveillance cameras can be searched and discovered in the M2M System based on search criteria such as type (e.g. video camera for traffic) and other meta-data (e.g. location or activation state).

In addition to (physical) devices the traffic application publishes “virtual devices” that act similar to sensors and provide derived data such as: number of vehicles that passed during the last minute/hour, average speed of vehicles ...

Also these “virtual devices” can be searched and discovered in the M2M System based on type and other meta-data.

However, in contrast to the previous case (real devices) virtual devices only implemented as software and do not require a Connectivity Layer. They are data structures published by the traffic application.

The traffic application charges other applications to receive data from these virtual devices.

Finally, the traffic application also publishes “things” in the M2M System like roads and intersections. Other “things” the traffic application might publish are phased traffic lights (green wave).

“Things” are similar to “virtual devices” but have relations to other “things” (e.g. a section of a road lies between two intersections).

A “street”, published by the traffic application, provides information on the average speed of traffic, congestion level, etc. A “series of phased traffic lights” provides information about which traffic lights are in phase, the current minimal/maximal/optimal speed, etc.

The “traffic application” of the Smart City charges other applications to access data from its published “things”.

A second Application Service, a “logistics application” is operated by a company that manages a fleet of trucks to deliver goods all over the country. This “logistics application” provides an optimal route for each truck at any time.

One of the trucks is currently driving in the Smart City. The logistics application has a service level agreement with the traffic application of the Smart City.

The logistics application discovers all things (streets, intersections...) that are relevant to calculate an optimal route for the truck, based on type and location. It uses the published data and is charged for the access to these data.

### 8.2.2 Source

oneM2M-REQ-2012-0073 Use Case on Devices - Virtual devices - Things

### 8.2.3 Actors

- The municipality of a Smart City (Application Service Provider)
- The fleet management company (Application Service Provider)
- The M2M Service provider (M2M Service provider)

## 8.2.4 Pre-conditions

- The municipality of a Smart City operates a “traffic application” that monitors traffic flow and switches traffic lights.
- The fleet management company operates a “logistics application” that manages a fleet of trucks.
- Both Applications are using the same M2M Service Capabilities Network (MSCN) operated by the M2M Service provider.
- The traffic application allows the logistics application to access some of its Devices, Virtual devices and Things.

## 8.2.5 Triggers

None

## 8.2.6 Normal Flow

- The traffic application creates Virtual devices (e.g. traffic sensors) and Things (e.g. streets, series of phased traffic lights...) for use by other M2M applications in the MSCN of the M2M Service operator.
- The traffic application publishes the semantic description (types, relations, and meta-data) of its Devices (e.g. cameras), Virtual devices and Things in the MSCN of the M2M Service operator. The traffic application restricts discoverability of its Virtual devices and Things to applications provided by business partners of the municipality of a Smart City.
- The traffic application enables access to the data of some of its traffic cameras to all M2M applications, but access to the data of virtual devices and things is restricted to applications of business partners (e.g. the logistics application).
- The logistics application searches the MSCN of the M2M Service operator for things and virtual devices in the vicinity of the truck. Based on the semantic search criteria (described by reference to a taxonomy or ontology) only the things and virtual devices that are useful for calculating the route of the truck are discovered.
- The logistics application reads the data from relevant things and virtual devices and calculates the optimal route for the truck.
- The logistics application is charged by the MSCN of the M2M Service operator for reading the data from things and virtual devices of the traffic application.
- The traffic application is reimbursed for usage of its things and virtual devices.

## 8.2.7 Alternative Flow

None

## 8.2.8 Post-conditions

Not applicable

## 8.2.9 High Level Illustration

None

## 8.2.10 Potential Requirements

1. The M2M System shall provide a capability to an Application shall be able to create Virtual Devices and Things in the M2M Service Capability Network.
2. The M2M System shall provide a capability to an Application shall be able to publish semantic descriptions and meta-data (e.g. location) of its Devices, Virtual Devices and Things in the M2M Service Capability Network.
3. The M2M System shall provide a capability to an Application to search for and discover Devices, Virtual Devices and Things in the M2M Service Capability Network based on their semantic descriptions and meta-data. The supported formats of semantic descriptions shall be described in the oneM2M standard.
4. The M2M System shall provide a capability to an Application shall be able to control, via the M2M Service Capability Network, access to semantic descriptions and meta-data of its Devices, Virtual Devices and Things.

- 1845 5. The M2M System shall provide a capability to an Application shall be able to allow, via the M2M  
1846 Service Capability Network, access to its Devices, Virtual Devices and Things to individual other  
1847 applications.  
1848

## 1849 8.3 Car/Bicycle Sharing Services

1850 -void –

1851  
1852 *Note:* This use case can be found in TR-0026 [i.20].

1853 Source: oneM2M-REQ-2012-0132R01 Use Case: Car/Bicycle Sharing Services

## 1856 8.4 Smart Parking

1857 -void –

1858  
1859 *Note:* This use case can be found in TR-0026 [i.20].

1860 Source: oneM2M-REQ-2013-0169R03 Use Case Smart Parking  
1861

## 1862 8.5 Information Delivery service in the devastated area

### 1863 8.5.1 Description

#### 1864 Background

- 1865 • When a disaster occurs in the metro area, many victims require various kinds of information such as  
1866 traffic, safety and evacuation area. However, it may be difficult to collect such information  
1867 immediately and properly.  
1868

#### 1869 Description

- 1870 • This is the use case of a M2M Service that transmits required information to the User Devices (UDs)  
1871 of disaster victims immediately and automatically. Some of the information shall be maintained  
1872 before a disaster happens.
- 1873 • UD connects to the Wireless Gateways (WGs). The WGs properly provide the UD with the  
1874 information stored on its local DB to avoid the network congestion.
- 1875 • When Disaster Sensor detect a serious disaster, the Service Provider multicasts the latest information  
1876 which the victims need such as traffic congestion, locations of closest hospitals and evacuation area.  
1877 The UD receives and update the information automatically.
- 1878 • After the disaster happens, the Service Provider continues to update the information according to the  
1879 situation of traffic, safety and evacuation area as well as the data from Disaster Sensors and  
1880 Equipment for public information.

### 1881 8.5.2 Source

1882 oneM2M-REQ-2012-0074R09 Use Case: Information Delivery service in the devastated area

### 1883 8.5.3 Actors

- 1884 • Service Provider has the aim to assist disaster victims by providing information to victims who have  
1885 User Devices (UDs).
- 1886 • Disaster Sensor shall detect a disaster and send the disaster detection to the Service Provider.
- 1887 • Equipment shall send information to the Service Provider.
- 1888 • The UD shall receive the information from the Service Provider to support the disaster victim in  
1889 emergency.
- 1890 • Wireless Gateway (WG) can send the information from the Service Provider to the UD by wireless  
1891 connection (e.g. Wi-Fi, 3GPP) in an emergency.

1892 **8.5.4 Pre-conditions**

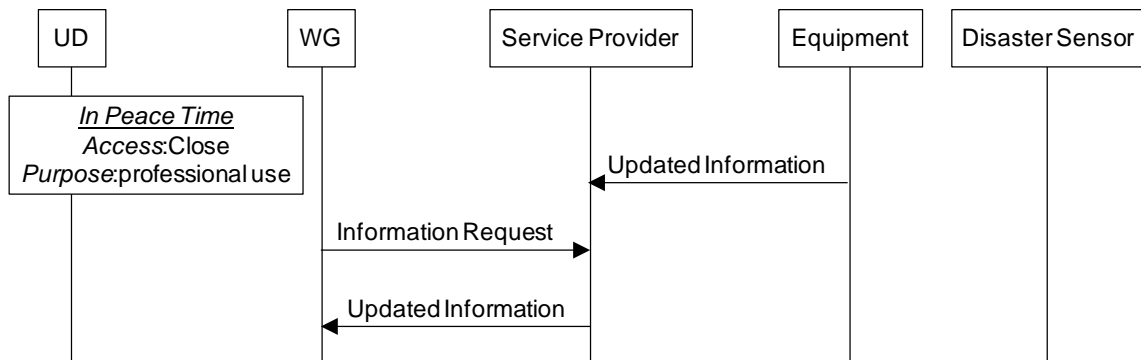
- 1893 • In times when disasters are not present (peace time), the Equipment collects information to be used for  
1894 disaster situations (emergencies). The information is maintained in the DBs on the Service Provider's  
1895 Disaster Information Network.
- 1896 • The Service Provider shall have reliable, secure communication with the Disaster Sensor by checking  
1897 the certificate issued by the Disaster Sensor.
- 1898 • When receiving information regarding a disaster from the Service Provider, the WGs shall have the  
1899 method to check if the information is reliable prior to distributing the information to UDs.
- 1900 • UDs shall be able to receive the message from the Disaster Sensor by the other communication paths.
- 1901 • The WG may be used for the other services for specific UDs in peace time. In case of emergency,  
1902 every subscribed UDs should be able to receive the message from the Service Provider through the  
1903 WG.
- 1904 • Communication connections among UDs, WGs and Service Provider are established.
- 1905 • When the network connectivity is available, the information on DB in the Service Provider-Disaster  
1906 Information Network and local DBs in the WGs should be capable of being regularly synchronized  
1907 and updated.

1908 **8.5.5 Triggers**

1909 The detection of a disaster (emergency) by the disaster sensor

1910 **8.5.6 Normal Flow**

1911 Normal flow for collecting information during a disaster



1914 **Figure 8-2 In Peace Time**



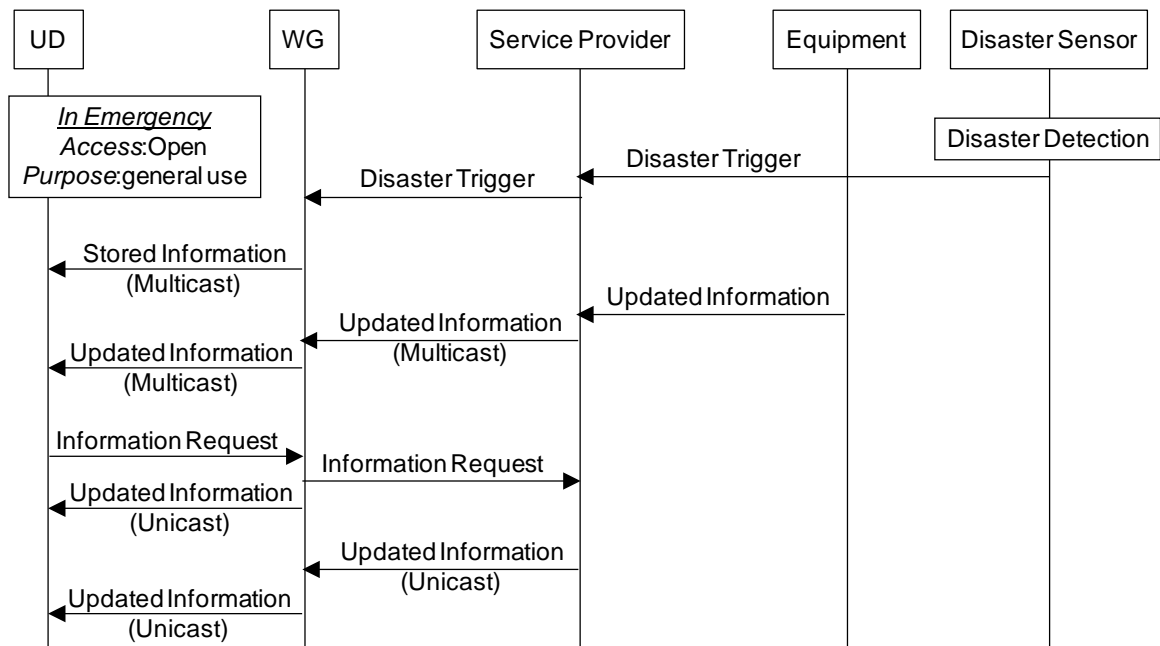


Figure 8-3 In emergency

1. WGs request the updated information from the Service Provider in peace time repeatedly and stores the information in their local DBs.
2. Disaster Sensors send messages to start the processing flow of the information delivery service to the Service Provider if they detect the disaster trigger.
3. The Service Provider should be able to allow every UD to access to the Databases in the WGs and Service Provider's Disaster Information Network.
4. The Service Provider sends the latest information to UD's automatically. WGs can send the stored information on the local DB to the UD's in order to suppress the network congestion.

### 8.5.7 Alternative Flow

UDs can request their dedicated information from WGs. When the network connectivity between the WG and Service Provider is established, WGs can request from the Service Provider the dedicated information for the UD's (e.g. family safety and their refuge area, personal medical information).

### 8.5.8 Post-conditions

Not applicable

### 8.5.9 High Level Illustration

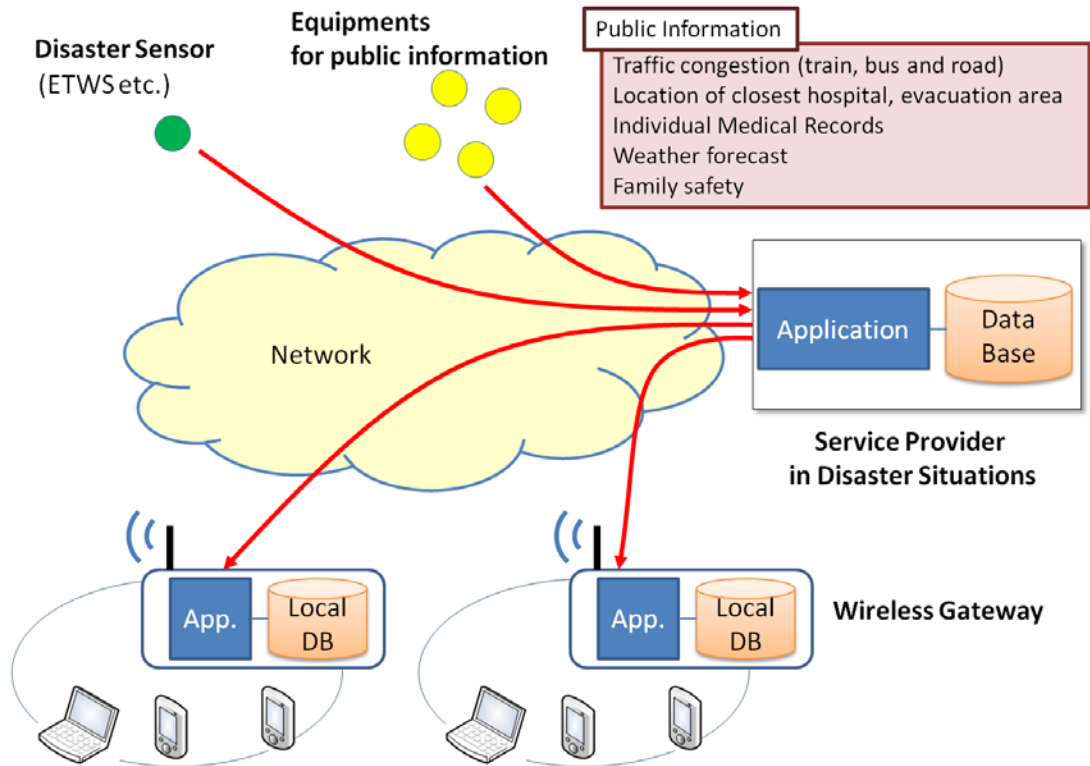


Figure 8-4 High Level System View

### 8.5.10 Potential Requirements

Table 8-1 Potential Requirements

Requirement ID	Classification	Requirement Text
HLR-088-a	Data reporting	The M2M System shall provide capabilities to Applications to update/synchronize Application specific databases between the Network Application and Gateway Application.  Fulfilled by HLR-041.
HLR-087	Data reporting	The M2M System shall support transmission of Application specific data (e.g. tsunami and earthquake detection sensor data) from Devices and oneM2M external sources (e.g. ETWS data) to Applications in the Network.  Fulfilled by HLR-046.
HLR-088-b	Data storage	A (wireless) Gateway shall be able to autonomously provide Devices that are attached via the LAN of the Gateway with trusted data that is locally stored in the Gateway.  Trusted data and retrieval fulfilled by HLR-041 ACLs.
HLR-088-c	Data reporting	When the WAN connection between the Gateway and Service provider is not possible, the Gateway shall continue to provide data that is locally stored on the Gateway to authorized Devices.
HLR-089	Data reporting	A (wireless) Gateway shall be able to transmit data (e.g. disaster warnings) to M2M Devices that are connected to the Gateway and are authorized to receive the data.  Fulfilled by HLR-010.

HLR-092-a	Security	A M2M Device that receives broadcast data from a (wireless) Gateway shall be able to verify that the (wireless) Gateway is authorized to broadcast the data (e.g. disaster warnings) and that the data is authentic. Fulfilled by HLR-185 and HLR-213.
HLR-092-b	Security	The M2M System shall provide capabilities to the Service Provider to enable/disable open access of M2M Devices to the Gateway. <ul style="list-style-type: none"> <li>• If access of M2M Devices to the Gateway is open any M2M Device shall be allowed to receive data from the Gateway.</li> <li>• If access of M2M Devices to the Gateway is not open only authorized M2M Devices shall be allowed to receive data from the Gateway.</li> </ul> Fulfilled by HLR-180, HLR-201

## 8.6 Holistic Service Provider

### 8.6.1 Description

In this use case a “Holistic Service Provider” provides M2M Application services for a large building, an industry facility, a sports complex, a public infrastructure, etc. In contrast to ‘normal’ M2M Application service providers a Holistic Service Provider mainly aggregates and combines data from other M2M Application service providers of the facility, e.g. to provide analytics ore forecast services.

In this use case a Holistic Service Provider for a football stadium provides the optimal fill status of the water reservoir of the stadium, taking into account:

- Event calendar and occupancy patterns for the planned events
- Current weather conditions and forecast,
- Ticket sales,
- lawn irrigation with the target to enable a high level of rain water

The requirement for such a scenario is that M2M Application service providers can provide limited access to a subset of their M2M data to the Holistic Service Provider. In addition this needs to be done in a semi-automated way that requires minimal human involvement

### 8.6.2 Source

REQ-2015-0527R01

*Note:* This use case has been gathered from material of the EU FP7 Project CAMPUS 21 (<http://www.campus21-project.eu>), in particular from Deliverable 1.1 “Analysis of Existing Business Models and Procurement Schemes” (<http://www.campus21-project.eu/media/publicdeliverables/D1-1.pdf>)

### 8.6.3 Actors

- **Holistic Management Service Provider (HM):** A company that provides holistic management services for energy, material and resource flows for any kinds of facilities. The actor provides the synergetic analytics over all data sources within different dimensions like time, space and context, and provides decision support for advanced facility control operations. This actor cooperates with the facility operator in order to provide holistic data management and control.  
According to oneM2M terminology the **HM** is a M2M Application Service Provider
- **Facility Operator (FO):** A company that is in charge of the operation of facility. The main focus is the main facility’s metering and control system (e.g. building automation systems) and therefore the operation of the facility in a cost- and energy-efficient manner. This actor will cooperate with third party facility services in order to enable holistic data integration. It is in charge of the business relations for all actors active within and for the facility.  
According to oneM2M terminology the **FO** is a M2M Application Service Provider

- **Third Party Facility ICT provider (TP):** A company which provides an additional sensor/ control/ metering system into the facility operated independently (installed permanently or temporarily, e.g. event ticketing system) from the main facility monitoring system. This actor might have a business relation with the facility operator, and enables access to its data.

According to oneM2M terminology the **TP** is a M2M Application Service Provider

All the above mentioned actors provide oneM2M System compliant M2M Application services.

## 8.6.4 Pre-conditions

- In order to provide services the Holistic Management Service Provider (HM) needs to get access to M2M data of multiple, independent Third Party Facility ICT providers (TP) in near real time. He needs to prove legitimacy of his request to access these data by some authorization of the Facility Operator (FO)
- The Facility Operator has established a business relationship with the Holistic Management Service Provider (FO ↔ HM)
- The Facility Operator has established business relationships with Third Party Facility ICT providers that provide:
  - The event calendar and ticket sales (TP for event management)
  - ticket sales solutions at the stadium
  - maintenance (temperature- and humidity control, irrigation) of the lawn of the stadium
  - maintenance (filling level, quality control, outflow- and inflow control) of the water reservoir of the stadium (FO ↔ TP)
- Facility Operator, Holistic Management Service Provider and Third Party Facility ICT providers has established business relationships with the M2M Service Provider. (FO, HM, TP ↔ M2M-SP)

Note, there is no business relationship between the Holistic Management Service Provider and Third Party Facility ICT providers.

## 8.6.5 Triggers

Not applicable

## 8.6.6 Normal Flow

1. Offline Step:
  - (a) The Holistic Management Service Provider (HM) requests the Facility Operator (FO) to provide him with data read-access to event calendar, ticketing information, lawn conditions and water reservoir conditions. These data are required with a certain quality/granularity (e.g. twice a day). Moreover actuation-access to the inflow of the water reservoir is requested
  - (b) The Facility Operator (FO) returns a list of IDs of Third Party Facility ICT providers (TP) whose Applications provide these data
2. The Facility Operator (FO) provides the HM with an electronic token that certifies the FO's consent to allowing the HM's applications to access Third Party Facility ICT provider (TP) data. This consent – and the token - is restricted to only
  - The TPs and the data of these TPs that are required for the holistic service
  - The necessary quality/granularity of the data.
 The Facility Operator (FO) can at any time revoke his consent by invalidating the electronic token
3. Based on list of IDs of TPs the M2M Application of the HM discovers relevant applications of the TPs

4. The M2M Application of the HM requests read / write access to the relevant data of the TPs applications. The electronic token provided by the FO is attached to this request to prove its legitimacy.
5. Since the legitimacy of the data access request is proven through the electronic token the TP enables the data access to the HM with the necessary quality/granularity of the data.

### 8.6.7 Alternative flow

Not applicable

### 8.6.8 Post-conditions

Not applicable

### 8.6.9 High Level Illustration

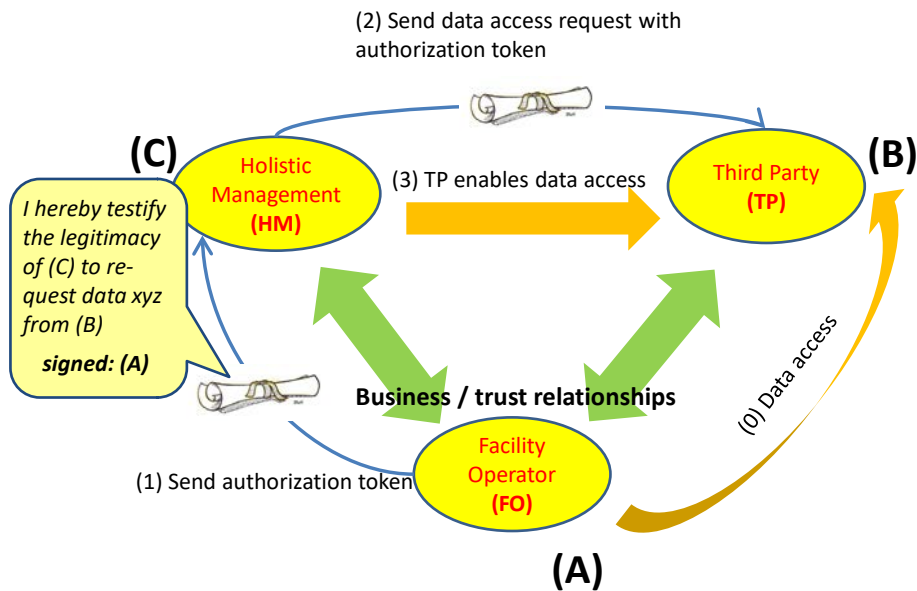


Figure 8-5 Holistic Service Provider High Level Illustration

### 8.6.10 Potential requirements

3. When an M2M Application (A) has access (read and/or write) to application data of another M2M Application (B) then (A) shall be able to create an electronic means - e.g. a token - that certifies the consent of (A) that a third M2M Application (C) is authorized to access these data too.
4. The M2M Application (A) shall be able to provide a third M2M Application (C) with this authorization token.
5. The M2M Application (A) shall be able to restrict the consent expressed in the authorization token to specify:
  - the authorized M2M Application (C)
  - the data accessed from a specified M2M Application (B)
  - the type of data access (read and/or write) and time when (how often) data can be accessed.

- 2054
- in case of subscription to the data the time granularity of providing data updates
- 2055
- 2056
- 2057
- 2058
- 2059
- 2060
- 2061
- 2062
- 2063
6. An M2M Application (B) shall be able to receive a request to access its data from an M2M Application (C) together with an authorization token that certifies the consent of M2M Application (A) that (C) has been authorized by (A) to access these data.
  7. The M2M Application (A) that had issued the authorization token shall be able to revoke the authorization token.
  8. When an authorization token has been revoked, then any M2M Application (B) that had granted access to its data based on the presence of this authorization token shall receive notification by the M2M System that the authorization token has been revoked.

---

2064

## 9 Residential Use Cases

2065

### 9.1 Home Energy Management

2066

#### 9.1.1 Description

2067 This use case is to manage energy consumption at home so that consumers can be aware of their daily home  
2068 energy consumptions and able to control this consumption by remote actions on home appliances. Innovative  
2069 services can be developed from the data (energy) collection and sent to either the consumers/ equipment or to  
2070 Business-to-Business market.

2071 The use case focuses on a home Energy Gateway (EGW) that collects energy information from the electrical  
2072 home network and communicates it to an M2M system for aggregating and processing of the data. Services  
2073 can then be developed from the collected data.

2074 The EGW performs an initial treatment of the data received from various sources (sensors, context) as follows:

- 2075
- aggregating and processing the obtained information:
  - sending some information to the remote M2M system e.g. sending alerts through the M2M system
  - using some information locally for immediate activation of some actuators/appliances
  - Is connected (wirelessly or via wireline) to home devices, including the home electrical meter, for information on global or individual consumption of the appliances
  - Providing displayable consumed energy-related information to the end-user/consumer terminals (PC, mobile phone, tablet, TV screen, etc.)
- 2076
- 2077
- 2078
- 2079
- 2080
- 2081
- 2082

Ref:[i.6] {HGI-GD017-R3 (Use Cases and Architecture for a Home Energy Management Service)}

2083

#### 9.1.2 Source

2084 oneM2M-REQ-2012-0058R03 Home Energy Management

2085 **Note:** from [i.2] ETSI TR 102 935 v2.1.1

2086

#### 9.1.3 Actors

- 2087
- User: user of home appliance
  - Communication operators: in charge of communicating the collected information via any protocol (e.g. ZigBee, PLC, Bluetooth 4.0 ...) to EGW and from the EGW to the M2M system
  - Energy gateway SP: in charge of collecting & transmitting securely energy information from appliances to the M2M system and receiving remote controls/commands from the M2M system
  - System operators/providers of service layer platform(s): in charge of providing services/common functionalities for applications (e.g. HEM) that are independent of the underlying network(s); e.g. they are in charge of collecting the status information of home devices and controlling them via the energy gateway.
  - Application Service Provider: Provides Home Energy Management (HEM) Application for the user through the M2M system
- 2088
- 2089
- 2090
- 2091
- 2092
- 2093
- 2094
- 2095
- 2096
- 2097

2098

#### 9.1.4 Pre-conditions

2099 None

2100

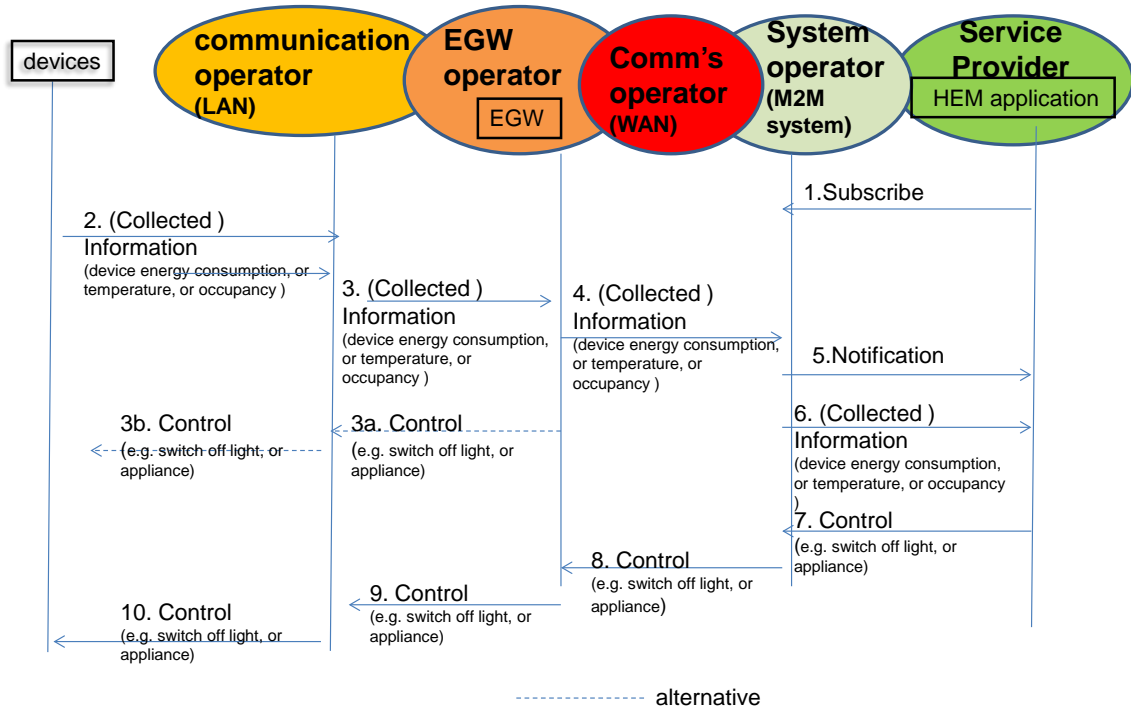
### 9.1.5 Triggers

2101

None

2102

### 9.1.6 Normal Flow



2103

2104

**Figure 9-1 Home Energy Management Normal Flow**

2105

2106

2107

2108

2109

2110

2111

2112

2113

2114

2115

2116

2117

2118

2119

2120

1. HEM application (M2M device) subscribe to System Operator/SP for information from home device(s).
2. Information from devices which could be M2M devices (smart meters, electric lightening, fridge, washing machine etc.) at home is collected by the Energy Gateway Operator (EGW) via communication network operator. . Information may include room, temperature, occupancy, energy consumption.
3. Collected information is stored in the EGW SP and may be processed at energy gateway. As a result, control message may be sent back to device from the energy GW depending on policies stored in the energy gateway.
4. Collected information may also be sent to system operator which contains the M2M service platform for storage via communication network.
5. Subscribed application (HEM) is notified information is available for processing. Its subscribe M2M operator can process the information before sending to HEM application depending on subscription profile.
6. HEM application reacts to the shared /collected information and can send control message (e.g. To switch a home device e.g. light /appliance or washing machine) via the system operator.
7. Control is propagated back through different operator to appropriate M2M device(s).

2121

### 9.1.7 Alternative Flow

2122

None

2123

### 9.1.8 Post-conditions

2124

Not applicable

## 9.1.9 High Level Illustration

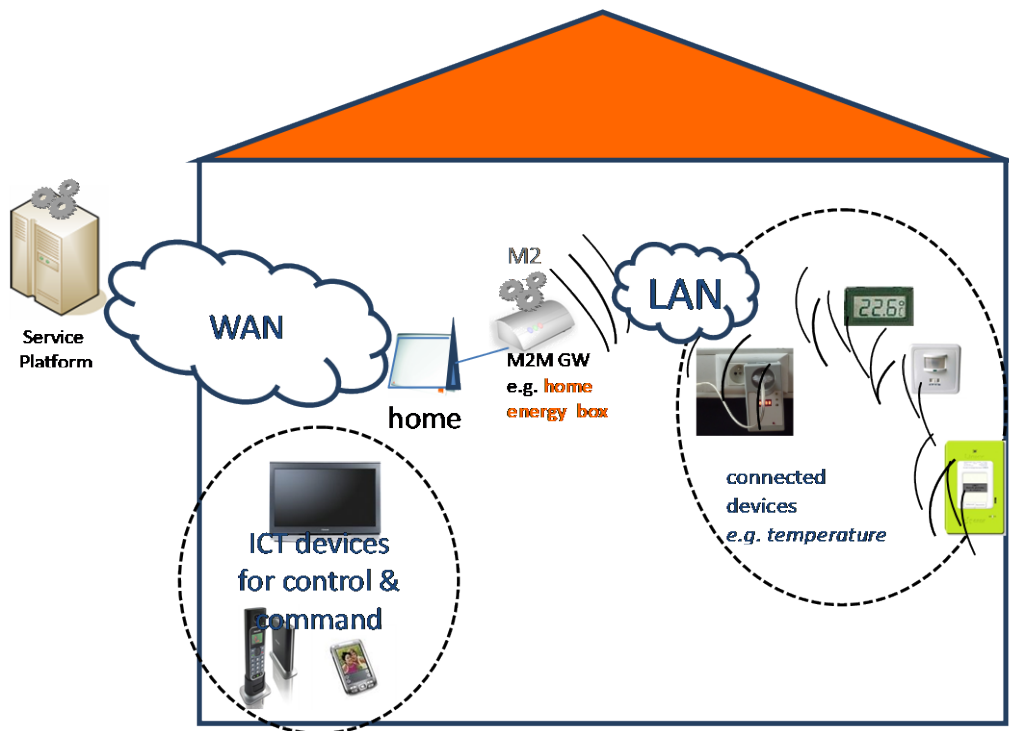


Figure 9-2 Home Energy Management System High Level Illustration

2126

2127

2128

2129

## 9.1.10 Potential Requirements

2130

2131

2132

2133

2134

2135

2136

2137

2138

2139

2140

2141

2142

2143

2144

2145

2146

2147

2148

2149

2150

2151

2152

2153

2154

2155

2156

2157

2158

2159

1. Similar to that of WAMS use case summarized as follows:
  - a. Data collection and reporting capability/function
  - b. Remote control of M2M Devices
  - c. Information collection & delivery to multiple applications
  - d. Data store and share
  - e. Authentication of M2M system with M2M devices/ /collectors
  - f. Authentication of M2M devices with M2M applications
  - g. Data integrity
  - h. Prevention of abuse of network connection
  - i. Privacy
  - j. Security credential and software upgrade at the Application level.
  - k. In addition the following requirements are needed:
    - l. The M2M system shall support a Gateway
    - m. The Gateway can be per home or per multiple homes e.g. a Gateway Concentrator.
2. Configuration Management
3. Pre provisioning of the M2M Devices and Gateways:
  - a. The M2M System shall support mechanisms to perform simple and scalable pre provisioning of M2M Devices/Gateways.
4. Management of multiple M2M Devices/Gateways
  - a. The M2M Application e.g. the HEM application shall be able to interact with one or multiple M2M Devices/Gateways, e.g. for information collection, control, either directly or through using M2M Service Capabilities.
  - b. The HEM application shall be able to share anonymous data with energy partners to provide the consumer with special energy rates.
5. Support for subscribing to receive notification:
  - a. The M2M System shall support a mechanism for allowing applications to subscribe and being notified of changes.
  - b. The M2M System operator shall be is able to support subscription of the HEM application to subscribe.
6. Support for optimizing notification:



2160 The M2M System shall be able to may support a mechanism for delaying notification of Connected Devices in  
2161 the case of a congested communication network.

#### 2162 7. Support for store and forward

- 2163 a. The M2M System shall be able to support a mechanism to manage a remote access of information from  
2164 other Connected Devices. When supported the M2M system shall be able to aggregate requests and delay  
2165 to perform the request depending on a given delay and/or category e.g. the M2M application does not have  
2166 to connect in real time with the devices.  
2167  
2168

## 2169 9.2 Home Energy Management System (HEMS)

### 2170 9.2.1 Description

2171 This use case introduces several services based on HEMS technologies.

2172 Home appliances from multiple vendors are connected to a LAN or PAN, and controlled by the gateway  
2173 device.

2174 The gateway device aggregates functionalities of home appliances by getting their status and sending this to  
2175 the management server.

2176 The gateway device is also upgradable to host newly released home appliance(s).

2177 The gateway device provides an API for remote control which takes privacy and authorization issues into  
2178 account.

### 2179 9.2.2 Source

2180 oneM2M-REQ-2012-0072R05 Use Case Home Energy Management System (HEMS)  
2181

### 2182 9.2.3 Actors

- 2183 • User: user (owner) of the home appliances
- 2184 • Home Appliance: appliances which may be from multiple vendors and are monitored and/or controlled  
2185 energy consumption
- 2186 • Gateway Device: a device installed in the user's home and receives remote control commands from the  
2187 management server
- 2188 • Management Server: the server which is in charge of collecting the status of appliances and controlling the  
2189 appliances via the gateway device
- 2190 • HEMS Application Server: the server which provides HEMS service for the user through the remote  
2191 management server

### 2192 9.2.4 Pre-conditions

- 2193 • WAN connectivity to the Gateway Device is installed
- 2194 • Service contract is required, and authentication credentials for the Management Service are installed on the  
2195 Gateway device.

### 2196 9.2.5 Triggers

2197 New Air Conditioner (for example) is installed

### 2198 9.2.6 Normal Flow

- 2199 1. User operates the Gateway Device to identify newly installed Air Conditioner (A/C) on the LAN.
- 2200 2. The newly installed A/C is identified by the Gateway Device.
- 2201 3. The Gateway Device requests the Management Server to provide support software for the A/C.
- 2202 4. The support software is installed on the Gateway Device.
- 2203 5. The Gateway Device registers the functionalities of the A/C to the Management Server.
- 2204 6. The Management Server notifies the event of the installation of the A/C to the HEMS Application Server.
- 2205 7. The HEMS Application Server is reconfigured with the newly installed A/C.
- 2206 8. The HEMS Application Server receives the latest status of all of the Home Appliances including the  
2207 newly installed A/C from the Management Server.

9. The HEMS Application Server sends management command(s) to the Management Server to minimize energy consumption.

### 9.2.7 Alternative Flow

None

### 9.2.8 Post-conditions

Energy consumption within the home is minimized by monitoring and controlling Home Appliances.

### 9.2.9 High Level Illustration

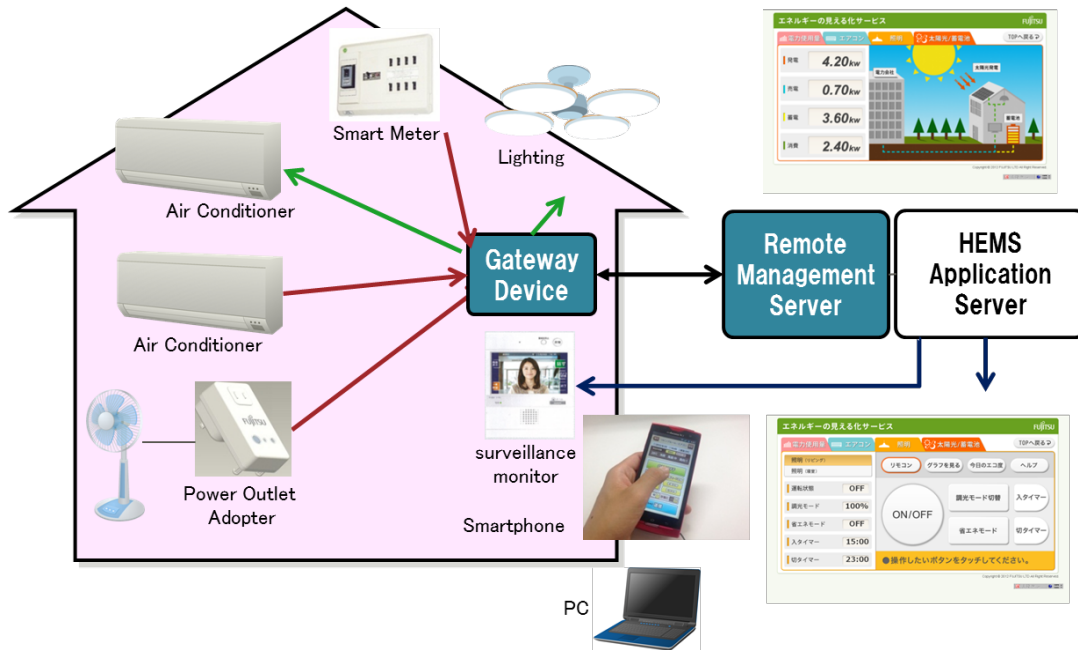


Figure 9-3 Home Energy Management System High Level Illustration

### 9.2.10 Potential Requirements

1. Gateway Device shall have the following requirements.
2. To detect the newly installed Home Appliance.
3. To be provided with appropriate pre provisioning configuration which is required to host the Home Appliances?
4. To support Home Appliances from multiple vendors as an abstracted object model.
5. To allow control to be overridden of the Home Appliances by User's direct operation.

## 9.3 Plug-In Electrical Charging Vehicles and power feed in home scenario

### 9.3.1 Description

The aim of the Plug-In Electric Vehicle (PEV) Charging and Power feed use case is to show the interaction between the different actors that can be involved in the charging of Electric Vehicle in home scenario. The scenario includes engagement of various actors:

- Electricity-Network Service Provider (Electricity-N/W-SP),
- Dedicated Electric Vehicle Charging SP (EVC-SP) who takes care of special functions like the Demand Response (DR) enablement (cost effective PEV Charging and Power Feed),

- 2236
- PEV-SP in charge of functions related to PEV service and maintenance (providing a data connection for PEV health purposes such as managing Power Feed cycles, PEV-SW upgrading & remote fault analysis, etc.)
- 2237
- 2238
- 2239
- PEV manufacturer in charge of replacing faulty parts for the PEV
- 2240

2241 PEV can be considered as a load and also as power storage (DER resource). In the latter case, a Power Feed from the PEV's battery into the Electricity-N/W is required.

2242 The Electricity-N/W-SP is responsible for the residential homes (smart) metering. Depending on local laws, 2243 the metering for the (Electrical Vehicle Charging Equipment) EVCE may be independent and might be a 2244 physical part of the EVCE.

2245 Depending on the PEV's brand, a parallel wired data connection may be included in the EVCE charging plug 2246 to enable the PEV's controller to access its agreed service and maintenance provider (PEV-SP). In case of no 2247 wired connection (high data rate, e.g. Ethernet), a short reach link, e.g. via ZigBee® or even Bluetooth® may 2248 be established (medium data rate ~2 Mb/s). This connection will then be routed via the EVCE's mobile 2249 broadband link to the PEV-SP's control centre in parallel to the charging and power feed control data, which is 2250 routed to the EVC-SP's control centre.

2251

2252 Related Standard activities:

- TC 69 committee: working on [i.7] ISO/ IEC 15118 parts 1-4, vehicle to grid communication; currently under development
  - EU standardisation Mandate 486 to CEN, CENELEC and ETSI (for further information refer to [i.8] Mandate 486)
  - Open 2G: using [i.9] DIN specification 70121 and [i.7] IEC 15118
  - DIN specification [i.9] 70121 defines the requirements for the communications between the electric vehicle (EV) and the charging EVCE).
- 2254
- 2255
- 2256
- 2257
- 2258
- 2259
- 2260

## 2261 9.3.2 Source

2262 oneM2M-REQ-2012-0059R02 Plug-In Electric Vehicle Charging (PEV)

2263 *Note:* from [i.2] ETSI TR 102 935 v2.1.1

## 2264 9.3.3 Actors

- Electricity Network service provider (Electricity N/W-SP/DSO) is responsible for the residential homes smart metering.
  - Electricity vehicle charging service provider (EVC-SP) takes care of special functions like the Demand Response (DR) enablement (cost effective PEV Charging and Power Feed)
  - PEV service provider (PEV SP) offering functions in conjunction with PEV service and maintenance (PEV health check and management such as management of power feed cycles, PEV-SW upgrading & remote fault analysis, etc.)
  - Communication operator /provider provide the public wireless data service to PEV-SP and EVC SP control centres.
- 2265
- 2266
- 2267
- 2268
- 2269
- 2270
- 2271
- 2272
- 2273

## 2274 9.3.4 Pre-conditions

2275 Connection from PEV to EVCE through a wired EVCE plug (data communication) or wirelessly (ZigBee or 2276 Bluetooth) or any short range technology.

2277 Public communication network from EVCE to PEV SP and EVCE SP control centres.

2278 Public communication between EVCE metering and El. N/W SP

## 2279 9.3.5 Triggers

2280 Control and pricing announcements from El. N/W SP to for example balance the power N/W

2281 Control and pricing trigger/initiate PEV being charged at a particular time with a specific power feed cycle that 2282 is appropriate for consumer (cheaper) and for El. N/W SP (balance power system).

2283 PEV health management through PEV control link to EVCE

2284 e.g. PEV SP initiates health check when PEV is plugged into EVCE for charging; if there is a problem detected 2285 or a PEV part status is over a certain limit, this will trigger a corrective measure according to health check 2286 result (e.g. PEV SP place an order for a part replacement to PEV manufacturer, or SW upgrade, etc.)

2287 EVCE SP will control and manage EVCE through EVCE control link;

### 9.3.6 Normal Flow

An example flow to show the interaction between PEV SP (PEV health check), PEV manufacturer (PEV defect part replacement) and EVC SP (metering/charging):

- Red colour to refer to flow related to EVC charging application
- Green colour refer to flow related to PEV SP application
- Blue colour refer to flow related to PEV manufacturer application

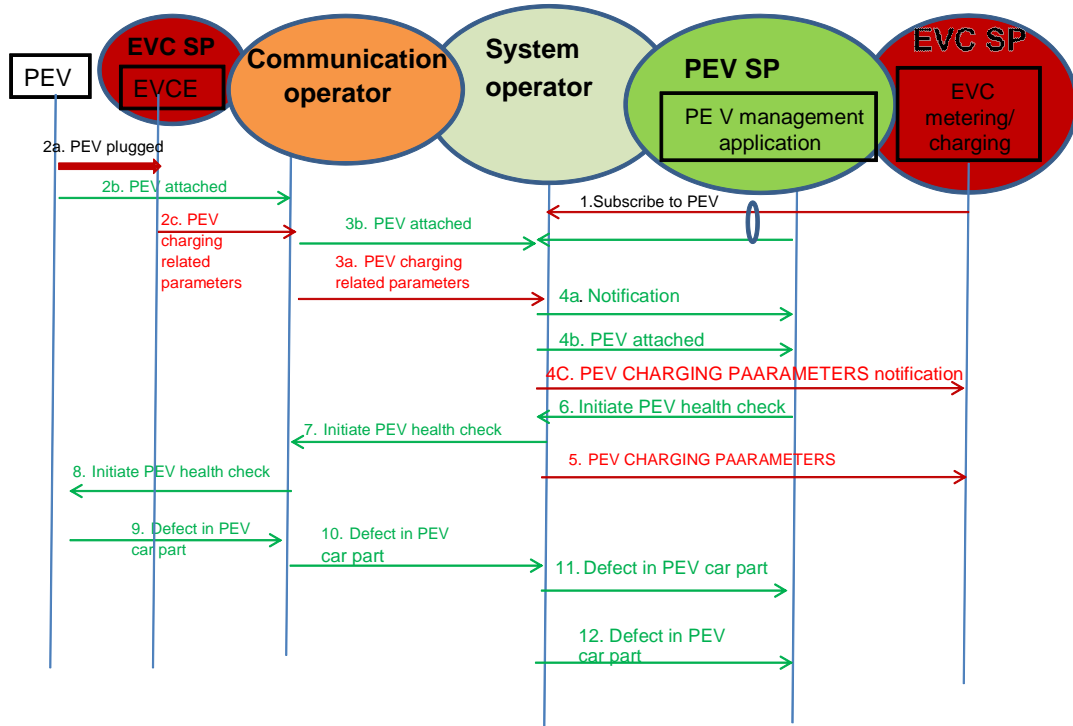


Figure 9-4 PEV Normal Flow

1. PEV management application and EVC metering/charging application subscribe to information related to PEV.
- 2.
- 2a. PEV is plugged to EVCE
- 2b. PEV related information (e.g. PEV1) is sent to communication operator
- 2c. PEV charging related information (e.g. .charging period)
3. Information sent in step 2 are sent to system operator which trigger the notification in step 4
4. Notifications are sent to the subscribed applications.
5. PEV charging parameters pulled/pushed to the EVC-SP
6. PEV management application sent an initiation of health check message to system operator
7. Initiation message is sent by system operator through communication operator to PEV to start the health check
- 8.-9. A PEV part defect is detected and a message is sent to the system operator, which triggers the notification of the PEV SP
10. System operator is sent a defect Notification to PEV SP application of the car part.
11. Which in turn send an order of the defected part to system operator
12. System operator sends the order to a PEV manufacturer

### 9.3.7 Alternative Flow

None

### 9.3.8 Post-conditions

Not applicable

## 9.3.9 High Level Illustration

### Plug-In Electric Vehicle (PEV) Charging & Power Feed

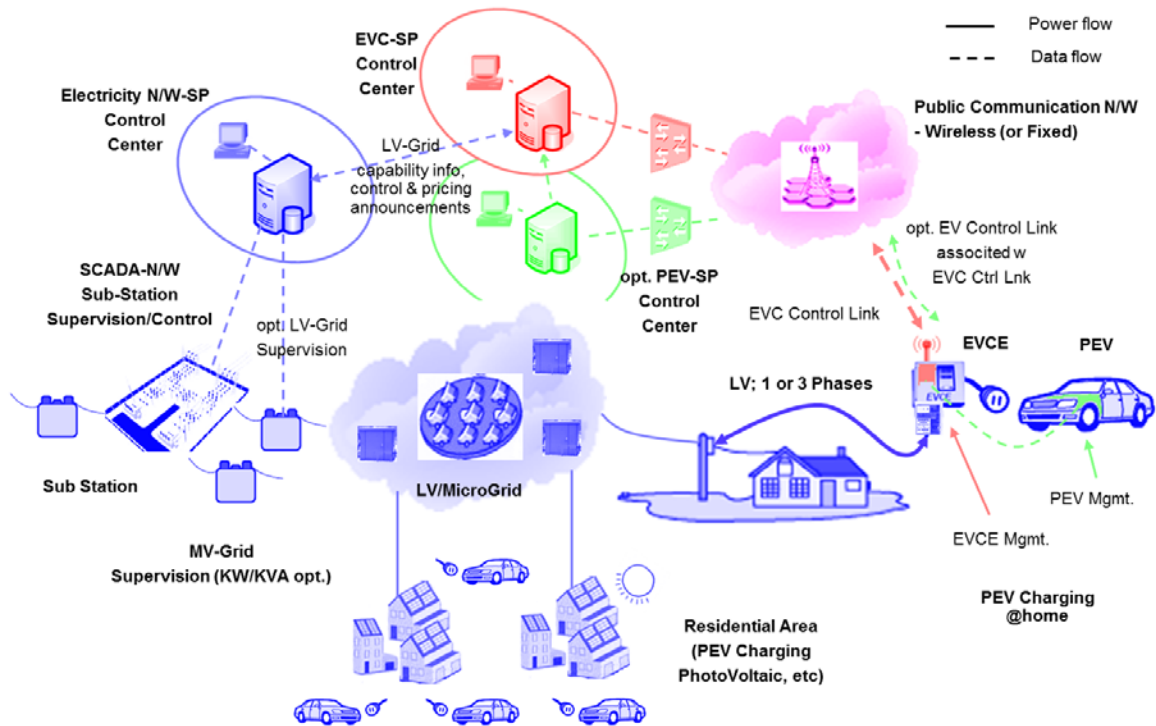


Figure 9-5 PEV Charging High Level Illustration

2322

2323

2324

2325

## 9.3.10 Potential Requirements

2326

2327

2328

2329

2330

2331

2332

2333

2334

2335

2336

2337

2338

2339

2340

2341

2342

2343

2344

2345

2346

2347

1. Secure communication of the following transactions:
  - i. SW upgrade by PEV manufacturer,
  - ii. Collecting PEV status info for health check will trigger control or command (e.g. order new part, trigger to do a car service) to another SP
  - iii. Collecting charging information (metering) from EVCE i.e. power feed cycle and time and charging period to the EVC-SP control centre (the metering could be home owned smart meter or Utility owned)
  - iv. Collection metering info from EVCE (PEV considered as a load or resource), to Electric N/W provider for billing purposes. Controlling EVCE e.g. SW upgrade, part order
  - v. Pricing info from Electricity Network SP to EVC SP
  - vi. Fleet management control centre to collect location information of PEV
2. Potential requirements are similar to those of WAMS:
  - i. Data collection and reporting capability/function including data delivery to multiple applications
  - ii. Remote control of M2M Devices
  - iii. Data store and share
  - iv. Authentication of M2M system with M2M devices/ /collectors
  - v. Authentication of M2M devices with M2M applications
  - vi. Data integrity
  - vii. Prevention of abuse of network connection
  - viii. Privacy
  - ix. Security credential and software upgrade at the Application level.

## 9.4 Real-time Audio/Video Communication

### 9.4.1 Description

So far, session control and Real-time audio/video communication are taken as basic capabilities in H2H telecom network. People may think that device does not need to listen or watch something from elsewhere except itself, thus there is no need for M2M system to support such kinds of human oriented capabilities, however, this is not the case. The following are some use cases in which session control for real-time audio/video communication is needed.

#### Use Case 1: Home Surveillance

One person, when travelling far from home, would like to use the application installed on his/her cell phone or pad computer to monitor his/her house, via the cameras fixed inside or outside his/her house. In the case the person makes a call to the camera through his/her cell phone or pad computer requesting for image/video transmission, the camera can answer the call request and automatically start transmission of images/video captured by the camera.

The camera may be able to initiate an audio/video call or send messages for alarm addressing to the cell phone of the person in the case there are abnormal images captured by the camera, e.g. the image changes or the camera are moved. The cameras can communicate with other M2M devices via wired or wireless network. The communication can be between the M2M application on the M2M device and the M2M application applied in a service centre which provides home surveillance service to the users.

In order to have a clearer look at the images captured by the cameras, some commands can be sent to the camera to adjust some parameters on the cameras, e.g. tilt, zoom in/out, adjust the focus, initiate recording, and so on. For easy and better control of the camera along with the video transmission, the commands can be transported within the same session as for video transmission. It is assumed that standalone session can be created to control the cameras as well.

The cell phone can also start calling the camera automatically according to some predefined rules. For example, the cell phone calls the camera and records the audio/video information automatically every night while the owner is sleeping.

#### Use Case 2: Doorbell Controller

One person, when he/she is away from home, his/her children or parents may forget to take the keys and lock them from entering into the house. After they push the door bell or door controller with cameras equipped, the application installed on the door bell or door controller may initiate a video call to the person's cell phone in which it shows who are standing before the door, and once the user answers the call reaching his/her cell phone, the door will open.

Also, when the motion detector equipped near the doorbell detects some abnormal movements near the door, the motion detector notifies the doorbell with a camera to start a call to the owner's cell phone. When the owner answers the phone, he/she will be able to make sure if the movements are normal.

#### Use Case 3: Customized Home Service

One person, when he/she is away from home, he/her may use his/her mobile device to coordinate appointments using calendar application or to search information on internet. His/her mobile device also can trace its location using GPS. By collecting the information, his/her life pattern/context and interests can be analysed.

Using well-analysed information, a service provider can provide user- customized home service with home appliances which have capability of showing video or playing audio like smart television or smart refrigerator.

He/she may come back to home and turn on TV. Channels would be recommended based on analysed data of his/her preference. Then commercial advertisement on TV would be shown regarding of his/her interest and personal information.

### 9.4.2 Source

oneM2M-REQ-2013-0281R02 Use Case real time audio video communication

oneM2M-REQ-2013-0398R01 Use Case of Additional audio video

### 9.4.3 Actors

- M2M Service Provider:

2403 A company that provides M2M service including one or more of the entities e.g. devices with camera,  
2404 oneM2M platform and service centre for surveillance and alarm reaction.  
2405

- 2406 • Service Centre:  
2407 The service centre provides home surveillance and other corresponding services, e.g. initiating an audio/video  
2408 call to the host of the home in case there are intruders or initiating a multimedia conference call for  
2409 consultation for a patient.

### 2410 9.4.4 Pre-conditions

- 2411 Before the audio/video call could be set up, the following steps are to be taken:
- 2412 • The Devices are configured with the number/address to which an audio/video call can be initiated for  
2413 alarm
  - 2414 • The oneM2M system allocates unique identifiers for the devices
  - 2415 • The devices need to be registered in the oneM2M system

### 2416 9.4.5 Triggers

2417 None

### 2418 9.4.6 Normal Flow

- 2419 1. The device registers in oneM2M system.
- 2420 2. When receiving request towards or from the device for an audio/video call, the oneM2M system  
2421 authorizes if the originator is allowed to send the request.
- 2422 3. If it is allowed, the oneM2M system route the message accordingly and create a connection between the  
2423 originator and the receiver for real-time audio and video transfer, and even commands for camera control.
- 2424 4. After the communication is completed, the oneM2M system releases the connection and resources.

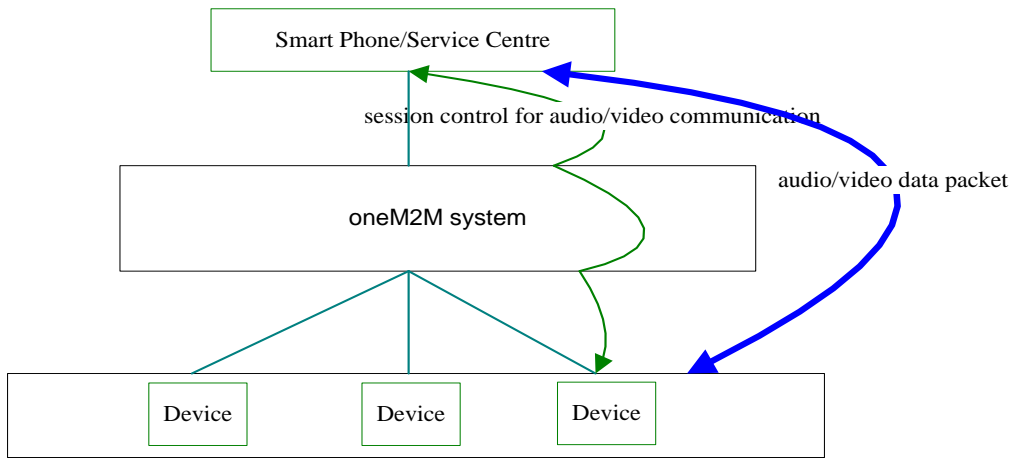
### 2425 9.4.7 Alternative Flow

2426 None

### 2427 9.4.8 Post-conditions

2428 Not applicable

### 2429 9.4.9 High Level Illustration



2430  
2431 **Figure 9-6 High Level Illustration of Real-time Audio/Video Communication**

### 2432 9.4.10 Potential Requirements

- 2433 1. The oneM2M system shall provide a capability to allocate unique identifiers to devices for  
2434 identification and session routing in oneM2M system.

- 2435 2. The oneM2M system shall support to establish and terminate real-time audio/video session between  
2436 M2M applications.  
2437 3. The oneM2M system shall provide a capability for a device to be registered in the system.  
2438 4. The oneM2M system shall support authorization if a request to and from the device for real-time  
2439 audio/video call establishment is allowed.  
2440 5. The oneM2M system shall provide a capability for routing a request for real-time audio/video call  
2441 establishment from or to the device.  
2442 6. The oneM2M system shall provide a capability for media control (e.g. negotiation of transcoding,  
2443 QoS) between the M2M applications for real-time audio/video data packet transmission.  
2444  
2445

## 2446 9.5 Event Triggered Task Execution

### 2447 9.5.1 Description

2448 Gateway Device may be required to configure for executing some tasks which are triggered by pre-defined  
2449 events.

### 2450 9.5.2 Source

2451 oneM2M-REQ-2013-0176R03 Event Triggered Task Exec Use Case  
2452 REQ-2015-0596 Event Trigger Use Case Revise

### 2453 9.5.3 Actors

- 2454 • Management Server,  
2455 • Gateway Device which has the characteristic both M2M Gateway (aggregate measured value) and M2M  
2456 Device (accepting setting change),  
2457 • Thermometer and Air Conditioner (M2M Device),  
2458 • Data Storage Server,  
2459 • User

### 2460 9.5.4 Pre-conditions

- 2461 • Gateway Device is configured to work as the gateway for collecting data from some sensor devices installed  
2462 at home network.  
2463 • Sensor Devices are configured to accept the management request from Gateway Device which requests  
2464 reporting measured data on demand

### 2465 9.5.5 Triggers

- 2466 • M2M System is going to configure Gateway Device for scheduling task execution for data collection from  
2467 sensor devices.

### 2468 9.5.6 Normal Flow

- 2469 1. Management Server requests management on scheduling task settings of Gateway Device to fetch the  
2470 current value of the thermometer, and report collected data from a thermometer (one of the Sensor Devices  
2471 in this use case) every 30 minutes.  
2472 2. Gateway Device establishes the connection to the thermometer, and collects measured data.  
2473 3. Gateway Device reports the collected data to Data Storage Server.

### 2474 9.5.7 Alternative Flow

2475 Alternative Flow 1

- 2476 1. (after step 2 in normal flow,) Gateway Device stores series of measured data associating with the  
2477 source Sensor Device.  
2478 2. Management Server requests Gateway Device to report the log data which summarize series of  
2479 measured data by Sensor Devices for one day.  
2480

2481 Alternative Flow 2



1. Management Server configures the M2M Application on the Gateway Device to start monitoring energy consumption of Air Conditioner, when the device is turned on, and to stop monitoring when that is turned off.
2. M2M Application on the Gateway Device subscribes requests notification on the power status change of Air Conditioner.
3. When the user turned on the Air Conditioner, the Gateway Device is notified by event notation for the status change.
4. M2M Application on the Gateway Device starts monitoring the energy consumption of the Air Conditioner.
5. When User turned off the Air Conditioner, the M2M Application on the Gateway Device is notified the status change
6. Gateway Device stops monitoring the energy consumption of the Air Conditioner.

Alternative Flow 3

1. Management Server configures the M2M Application on the Gateway Device to report the energy consumption when the total energy consumption exceeded over the 20kW per day.
2. M2M Application on the Gateway Device keeps collecting data about energy consumption from home electronics (i.e. Air Conditioner).
3. When the total energy consumption exceeded over the 20kW per day, the M2M Application on the Gateway sends notify the report to the Data Storage Server.

### 9.5.8 Post-conditions

Collected data is stored on the Data Storage Server for further use

### 9.5.9 High Level Illustration

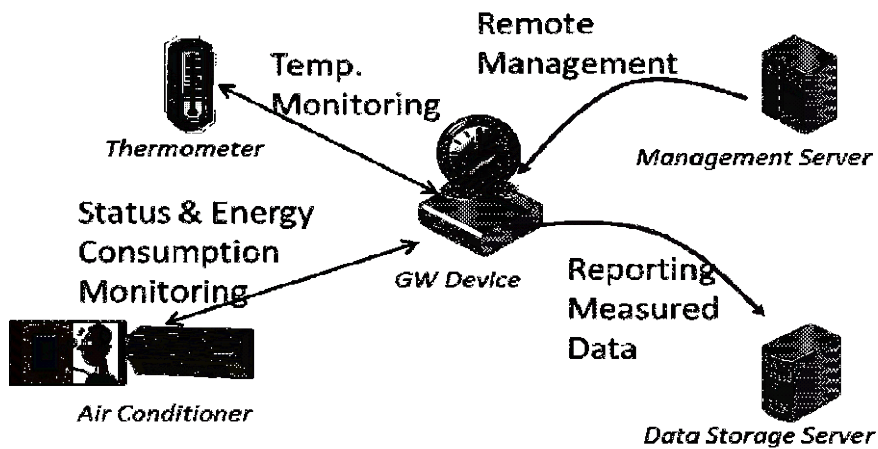


Figure 9-7 Event triggered Task Execution High Level Illustration

### 9.5.10 Potential Requirements

1. M2M System Shall support timer triggered data collection on M2M Gateway from M2M Device.
2. M2M System Shall support M2M Gateway which reports collection of data measured by M2M Device.
3. M2M System Shall support to start/stop monitoring measured data by M2M Device triggered by status change of M2M Device to be monitored.
4. M2M System Shall support conditional report from M2M Gateway which reports measured data by M2M Device(s). The condition can be expressed as event notification message which is triggered by M2M Application which is monitoring threshold and/or size of value change.

## 9.6 Semantic Home Control

### 9.6.1 Description

This use case demonstrates co-operation between two independent M2M applications. The co-operation is made possible because one application can find the other application through semantic information about the application's resources. This semantic information is available in the M2M System.

One application is a building management system (BMS) for a big apartment house. The BMS is operated by a building manager, e.g. the owner of the apartment house. BMS has knowledge about the blueprints of all the apartments in the house, e.g. it knows which heater is located in which room (heaters are assumed to be equipped with temperature sensors/actuators).

The other application is a home energy management system (HEMS). It has been subscribed by the tenant of one of the apartments. HEMS controls the heaters of the apartment (among other purposes).

Because HEMS can find the resources of BMS – e.g. the resource that represents the tenant's apartment and the heaters therein HEMS can configure itself automatically (and can adapt to changes over time) and doesn't require human configuration.

Finding the right resources in the M2M System is made possible through semantic annotation of the resources

### 9.6.2 Source

oneM2M-MAS-2013-0020 Semantic use cases from ETSI Semantics TR

### 9.6.3 Actors

- Building manager: is running a Building management system (BMS) for his apartment house.
- Tenant of an apartment: has subscribed to a home energy management system (HEMS) for his apartment.
- M2M service provider: is providing access to the M2M System for both applications, BMS and HEMS.
- Building management system (BMS): is a M2M network application.
- Home energy management system (HEMS): is a M2M network application.

### 9.6.4 Pre-conditions

The Building management system (BMS) is an M2M application that contains all the information needed to manage a large apartment house. In particular it contains the construction details of the tenant's apartment, where the doors and windows are located, where the heaters are, their capacity, etc. The BMS is used for overall control of the building, but information relevant for individual apartments (e.g. control of the heaters, built-in sensors for windows and doors) can be made available to authorized tenants. In case of fire, the complete blueprint of the house can be made available to fire-fighters.

In the M2M System the BMS makes its information available as M2M resources, similar to as if they were data transmitted by a device. E.g. the complete apartment, individual rooms, their heaters and windows could be represented as M2M resources.

A new tenant is renting an apartment in the house. As he is moving in, he also subscribes to a general-purpose home energy management system (HEMS) that promised a very efficient heater control. E.g. the HEMS always uses the best available electricity tariff and the heating is turned off when windows are open.

As part of the subscription, the HEMS is granted access to the respective resources used by the BMS in the M2M system. In particular, the building manager has permitted access of the tenant's HEMS to those resources of the BMS that are needed for energy management of the tenant's apartment (rooms, heaters, door- and window sensors, etc.). Other resources not needed for this task are not exposed to the HEMS.

### 9.6.5 Triggers

None

### 9.6.6 Normal Flow

The newly subscribed HEMS will immediately start discovering new devices in the apartment. Once the BMS has granted access, the HEMS will discover the resources of the BMS that are related to the apartment. Using the semantic description of the devices the HEMS can immediately find out about the available rooms, heaters, temperature sensors, etc. With this knowledge it can configure itself without any human intervention.

Since the BMS has configured its devices to be represented in the M2M System as abstract devices, the HEMS can use this information to immediately control the devices using the offered abstract command set.

2569                   Consequently, HEMS does not have to understand the specifics (e.g. specific protocol) of a particular heater  
2570                   control.  
2571                   Later, the building manager installs a new device into the tenant's apartment which can help in efficient energy  
2572                   management. This new device is also managed by BMS. Using the selection rule of the HEMS service, the  
2573                   new device will get immediately available to the HEMS. The HEMS will discover the new device and will use  
2574                   it to control the apartment's energy consumption.

## 2575                   9.6.7 Alternative Flow

2576                   None

## 2577                   9.6.8 Post-conditions

2578                   Not applicable

## 2579                   9.6.9 High Level Illustration

2580                   None

2581

## 2582                   9.6.10 Potential Requirements

- 2583                   1. The M2M System shall support a common (e.g. per vertical domain) semantic data model (e.g.  
2584                   represented by Ontology) available to M2M application.
- 2585                   2. The M2M System shall provide discovery capabilities that enable the discovery of M2M resources  
2586                   based on their semantic information, e.g. semantic categories and relationship among them. (e.g. all  
2587                   heaters and windows in a room; the room in which a window is located...).
- 2588                   3. The M2M System shall provide representation and discovery functionality of real-world entities  
2589                   (rooms, windows) that are not necessarily physical devices.
- 2590                   4. The M2M system shall be able to map control commands issued towards an abstract device to the  
2591                   concrete commands of a specific device.
- 2592

## 2593                   9.7 Semantic Device Plug and Play

### 2594                   9.7.1 Description

2595                   This use case applies with any verticals, below just take home automation as an example. The use case is about  
2596                   when a device is newly registered in a home, it will find its own character and its relationship with its  
2597                   neighbour devices and Things automatically based on semantic information within the M2M system without  
2598                   the interference of human being. For example, the house owner bought a lamp and a switch to the lamp for his  
2599                   house. Both the lamp and switch is enabled with wireless abilities to be able to communicate with the home  
2600                   automation gateway and other devices. The lamp is for the lobby and accordingly the switch is located near the  
2601                   entrance of the lobby. When the house owner has placed the lamp and the switch properly, a simple power-on  
2602                   would make the lamp and the switch work fine.

### 2603                   9.7.2 Source

2604                   oneM2M-MAS-2013-0020 Semantic use cases from ETSI Semantics TR

2605

### 2606                   9.7.3 Actors

- 2607                   • Home automation service provider: is providing home automation service by providing applications running  
2608                   on home automation devices such as gateway, lamp, switch, TV, air-condition etc.
- 2609                   • Home automation management system (HAMS): is a network application.
- 2610                   • Device manufacturer: produces devices as M2M nodes.
- 2611                   • M2M service provider: provides M2M service acts as a platform where all M2M nodes can register to.
- 2612                   • House owner: is a consumer of the home automation service.

#### 9.7.4 Pre-conditions

The house owner has a contract with the home automation service provider for the home automation service. The home automation service provider has a business relationship with the M2M service provider and the device manufacturer. The home automation management system manages all the devices and their relationships registered in the house. Each device has its role and serves fixed services among all home devices.

#### 9.7.5 Triggers

None

#### 9.7.6 Normal Flow

When the house owner buys new devices for his house, the newly bought devices will register to the M2M service provider and expose to the M2M SP its role and functionalities including their semantic descriptions. According to such information, the HAMS will compare the semantic description of the new device with the semantic description of the existing devices in the house and judge their relationships by semantic inference. Then the HAMS will help establish the relationship between the new device and the device in the home and the relationship is maintained in the M2M SP. For example the HAMS finds that the lamp is to be controlled by the switch, it may then bind the status of the switch to the action of the lamp. If the status of the switch is ON, an "ON" command will be sent to the lamp automatically.

#### 9.7.7 Alternative Flow

None

#### 9.7.8 Post-conditions

Not applicable

#### 9.7.9 High Level Illustration

None

#### 9.7.10 Potential Requirements

1. The M2M System shall support a semantic data model that is at least common to the vertical industry in which a Thing is used to describe Things registered in the M2M System.
2. The M2M entity shall be able to expose its semantic description to the M2M System.
3. If a Thing is capable to expose semantic information to the M2M System the M2M System shall be able to use that information to represent the Thing.
4. The M2M System shall be able to describe the semantic relationship between Things.

### 9.8 Triggering in the Field Domain

- void -

Note: This use case can be found in TR-0013 [i.17]

Source: REQ-2014-0447 Use case for Triggering in Field Domain

---

## 2651 10 Retail Use Cases

### 2652 10.1 Vending Machines

#### 2653 10.1.1 Description

2654 In some situations, vending machine providers need to limit the network access for vending machines based on  
2655 their geographic location. The providers do NOT want the vending machine user to move the machine from  
2656 the specified area to other locations (potentially for better sales), so that the providers can control the  
2657 geographic distribution of their vending machines and make decisions based on data statistics and analysis (e.g.  
2658 which are the best-selling areas? How many products are sold in specified areas during specified time? (and so  
2659 on).

#### 2660 10.1.2 Source

2661 REQ-2014-0466R05 Use case for vending machine

#### 2662 10.1.3 Actors

- 2663 • Vending machine, which can automatically sell products and report data information to the application  
2664 platform through M2M service platform
- 2665 • The M2M service platform, which can control the vending machine device and its access to the network
- 2666 • Vending machine application platform, which can accept the data report from vending machine, monitor its  
2667 status, and perform data analysis.

#### 2668 10.1.4 Pre-conditions

2669 The location information of the Vending machine is provided to the M2M Service platform by the Underlying  
2670 network.

#### 2671 10.1.5 Triggers

- 2672 • Vending machine restarts and registers to M2M service platform
- 2673 • Vending machine reports data information (e.g., each sale transaction or products selling information and so  
2674 on).

#### 2675 10.1.6 Normal Flow

- 2676 • The vending machine restarts and registers to M2M service platform.
- 2677 • The M2M service platform checks the geographic location policy. If current geographical location of the  
2678 vending machine is in the permitted area, it allows the vending machine to register. Otherwise, it denies  
2679 access.
- 2680 • After vending machine successfully registers, it reports data information (for example, the product selling  
2681 information and the stock information) periodically or for each product sale to the vending machine  
2682 application platform through M2M service platform.
- 2683 • The M2M service platform checks the geographic location policy. If the current geographic location of the  
2684 vending machine is in the permitted area, it allows for the data report. Otherwise, it will be denied.
- 2685 • The vending machine application platform receives the data information report, records the information and  
2686 performs data analysis.

#### 2687 10.1.7 Alternative Flow

2688 None

#### 2689 10.1.8 Post-conditions

2690 Not applicable

## 10.1.9 High Level Illustration

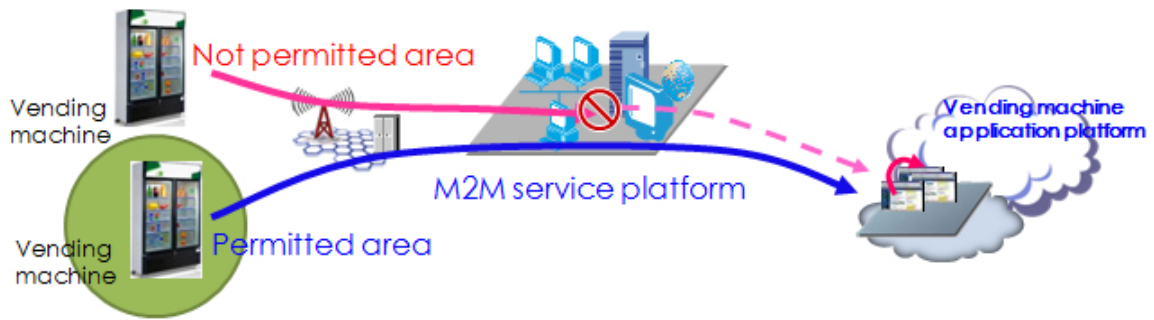


Figure 10-1 – High level illustration of Vending Machines use case

## 10.1.10 Potential Requirements

1. The M2M service platform shall be able to support the geographic location-based network access policy. (see also requirement OSR-047)
2. The M2M service platform shall be able to support a geographical boundary within a network access policy. (see also requirement OSR-047)

---

# 11 Transportation Use Cases

## 11.1 Vehicle Diagnostic & Maintenance Report

- void -

*Note:* This use case can be found in TR-0026 [i.20].

Source: oneM2M-REQ-2012-0067R03 Vehicle Stolen and Vehicle Diagnostics

## 11.2 Remote Maintenance Services

- void -

*Note:* This use case can be found in TR-0026 [i.20].

Source: oneM2M-REQ-2013-0188R06 Use Case Remote Maintenance

## 11.3 Traffic Accident Information Collection

- void -

*Note:* This use case can be found in TR-0026 [i.20].

Source: oneM2M-REQ-2013-0264R05 Use Case Traffic Accident Information Collection

Note: From [i.9]ETSI TR 102 638

## 11.4 Fleet Management Service using DTG (Digital Tachograph)

- void -

*Note:* This use case can be found in TR-0026 [i.20].

2728 Source: oneM2M-REQ-2013-0219R01 Use case – Fleet management using DTG  
2729  
2730

## 2731 11.5 Electronic Toll Collection (ETC) Service

2732 - void –  
2733  
2734

2735 *Note:* This use case can be found in TR-0026 [i.20].

2736 Sources:

2737 REQ-2014-0431R03 Use cases for Electronic Toll Collection (ETC) service

2738 REQ-2014-0449R02 Use cases for Electronic Toll Collection (ETC) service  
2739  
2740

## 2741 11.6 Taxi Advertisement service

2742 - void –  
2743

2744 *Note:* This use case can be found in TR-0026 [i.20].

2745 Source: REQ-2014-0467R02 Use case for taxi advertisement  
2746  
2747

## 2748 11.7 Vehicle Data Service

2749 - void –  
2750  
2751

2752 *Note:* This use case can be found in TR-0026 [i.20].

2753 Source: REQ-2014-0472R06 Use Case on Vehicle Data Services  
2754  
2755  
2756

## 2757 11.8 Smart Automatic Driving

2758 - void –  
2759

2760 *Note:* This use case can be found in TR-0026 [i.20].

2761 Source: REQ-2015-0554-Smart Automatic Driving  
2762  
2763  
2764

## 2765 11.9 Vehicle Data Wipe Service

2766 - void –  
2767

2768 *Note:* This use case can be found in TR-0026 [i.20].

2769 Source: REQ-2015-0589R04 Use case on vehicle data wipe service  
2770  
2771  
2772

---

## 12 Other Use Cases

### 12.1 Extending the M2M Access Network using Satellites

#### 12.1.1 Description

This Use Case demonstrates a scenario that extends the M2M access network using satellite communications. It serves to emphasize that satellite communication is a key component of the network domain to be incorporated in future requirements work at OneM2M on Smart Metering and other M2M use cases. In locations that are difficult to reach with fixed-line or cellular communications, a machine-to-machine (M2M) satellite solution extends terrestrial coverage and provides access to devices that require remote monitoring and control. Satellite-based communication networks provide communications that integrate seamlessly with any remote IP based application. Satellite networks offer IP connectivity, ubiquitous real time coverage, robust security, high availability compared to cellular networks. Satellite M2M solutions are also much more cost-effective than some years due to advances in satellite technology. Traditional satellite communications has had a stigma of being expensive and requiring large, power-hungry terminals too complex to integrate with applications. Modern satellite networking, however, provides competitive price solutions, ubiquitous coverage, and a high level of availability which compliment terrestrial networks. For this reason, it is important to consider satellite services for Supervisory Control and Data Acquisition (SCADA) applications, low data rate (LDR) solutions, and other remote, unmanned machine-to-machine (M2M) services.

#### 12.1.2 Source

oneM2M-REQ-2012-0061R02 Use Case Smart Metering with Satellite Communications

#### 12.1.3 Actors

- Service Providers for M2M

#### 12.1.4 Pre-conditions

The following additional functionalities or sub scenarios are explained in a high level format, to relate to electricity, gas, heating, and water.

##### 1. Distribution Automation

Deploying satellite M2M services along power distribution lines, as a supporting link, allows electrical utility providers to connect to their data centres and extend their network reach to the boundaries of their entire service territory, improving decision-making and operational efficiencies. A single, two-way IP data connection provides automated monitoring and control of re-closers, switches, or other distribution devices – anywhere - enabling utility providers to maintain continuous surveillance and control of their distribution network for voltage fluctuations, outages and service demands.

##### 2. Substation Connectivity

M2M Satellite communications provide services for electricity substations in locations that may be difficult to reach with fixed-line or cellular communications.

M2M Satellite communications contains the flexibility to cope with both low-volume high-frequency traffic and bursts of high-volume, low-frequency traffic. If a primary link breaks down, satellite communications can automatically provide backup communications at any substation.

##### 3. Disaster Recovery

Business continuity is vital for utilities that provide essential services such as electricity, water and gas to millions of people as they need to be able to recover immediately from natural or manmade disasters. When a catastrophic event causes terrestrial networks to fail, utilities companies can rapidly deploy satellite terminals to provide an alternative communications path, enabling them to maintain communications, diagnose issues quickly, and run critical applications.

#### 12.1.5 Triggers

The need to access M2M user devices (UDs) that may not be reachable with terrestrial and wireless networks.



2822 12.1.6 Normal Flow

2823 An example of a M2M communication using satellite service is Smart Metering (valves, electricity meter, gas  
2824 meter, water meter, and heat meter). Smart Metering devices over a small area connect to aggregation points or  
2825 Smart Meter Concentrators via a local, meshed wireless network. These aggregation points, or concentrators,  
2826 collect usage data and distribute control data to and from consumers in a limited geographical area,  
2827 transmitting it back to the utility’s data centre (Figure 12-1).

2828 The satellite connectivity backhauls Smart Meter data from a satellite antenna mounted on an Advanced  
2829 Metering Infrastructure (AMI) concentrator to the utility’s data centre. Each AMI concentrator links to  
2830 multiple smart meters via a local wireless network.

2831 In this configuration example, satellite communications co-locate with the primary gateway communication to  
2832 aggregate meter data at the gateway, extending the network reach across a utility’s entire service.

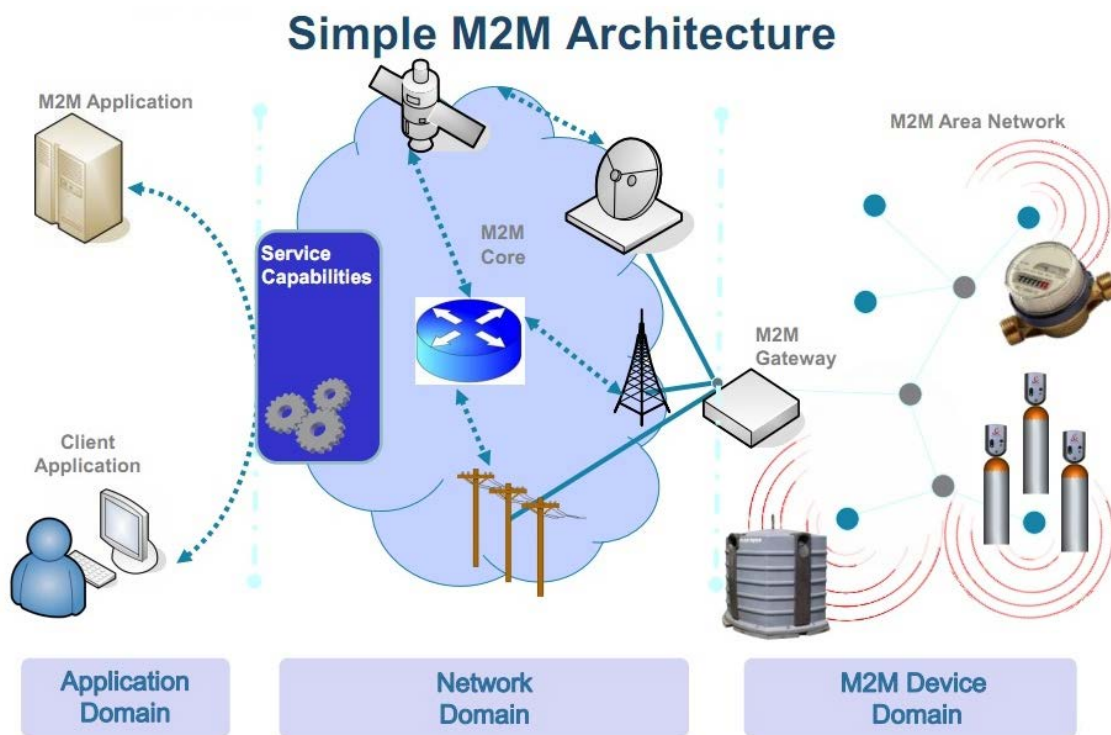
2833 12.1.7 Alternative Flow

2834 None

2835 12.1.8 Post-conditions

2836 Not applicable

2837 12.1.9 High Level Illustration



2838  
2839  
2840 Figure 12-1 Extended Smart Metering Configuration (source: ETSI)

2841 12.1.10 Potential Requirements

- 2842 1. Satellite access shall be considered in all M2M network domain architectures.

## 12.2 M2M Data Traffic Management by the Underlying Network Operator

### 12.2.1 Description

According to the data traffic condition, e.g. current traffic congestion status, in underlying networks, the underlying network operators (e.g. mobile network operators) would like to manage the M2M data traffic in their networks in conjunction with M2M service platform and/or M2M application server providers in order to avoid losing the M2M communication data packets in the networks.

The M2M service platform and/or M2M application server providers will change their configuration such as data transmission interval or stop sending data over the underlying networks for some duration after receiving the notification from underlying networks.

This use case illustrates handling of M2M data transmission based on the data traffic condition information of underlying network and interworking among the M2M service application server, M2M platform and the underlying network.

### 12.2.2 Source

oneM2M-REQ-2013-0175R03 Use Case on M2M data traffic management by underlying network operator

### 12.2.3 Actors

- The M2M application server providing data transmission control according to the data traffic condition of underlying network  
The application server has functions to receive data traffic condition information from the M2M platforms and/or the underlying networks, and control M2M data transmissions according to the received information.
- The M2M service platform providing data transmission control according to the data traffic condition information of underlying networks  
The M2M service platform has functions to receive the data traffic condition information from the underlying networks, and/or control M2M data transmissions according to the information.
- The underlying network providing the data traffic condition information  
The underlying network has functions to send the data traffic condition information to M2M application servers, M2M service platforms, and/or M2M devices.  
The data traffic condition information includes required transmission interval, required maximum data rate, required maximum data volume, current traffic congestion status, congested network area information etc.
- The M2M device providing data transmission control according to the data traffic condition information  
The M2M device to receive the data traffic condition information from the underlying networks or M2M service platforms, and control M2M data transmissions.

### 12.2.4 Pre-conditions

The underlying network monitors the status of the data traffic, analyse the status, define the traffic condition and provides the data traffic condition information to M2M application servers, M2M platforms and/or M2M devices.

### 12.2.5 Triggers

None

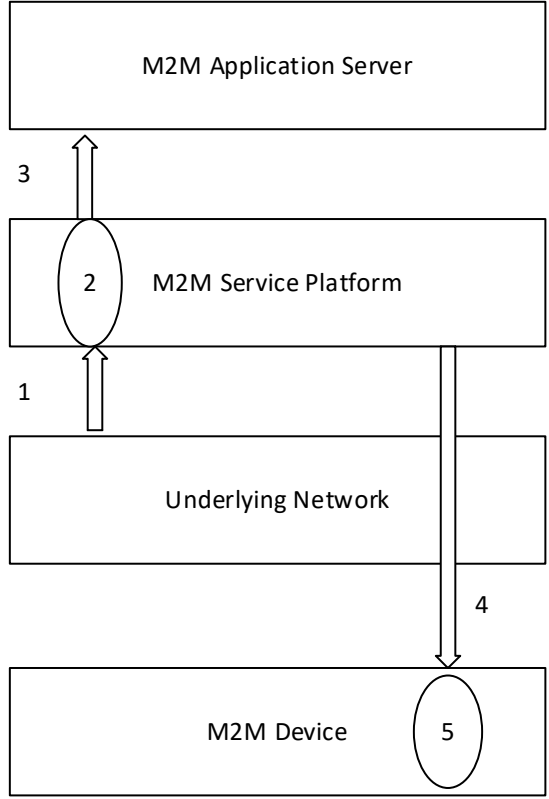
### 12.2.6 Normal Flow

Normal Flow 1:

1. The mobile network sends the data traffic condition information to the M2M service platform and/or M2M application server.
2. After the M2M service application server receives the data traffic condition information from the underlying network in step1, and it controls M2M data transmission accordingly.

2892  
2893  
2894  
2895  
2896  
2897  
2898  
2899

3. After the M2M application service platform receives the data traffic condition information from the underlying network in step 1 via the M2M service platform, it and controls M2M data transmissions accordingly.
4. The M2M service platform may send M2M data transmission configuration information to the M2M device.
5. After the M2M device may receive M2M data transmission configuration information from the M2M service platform in step 4, it and may controls M2M data transmissions accordingly.



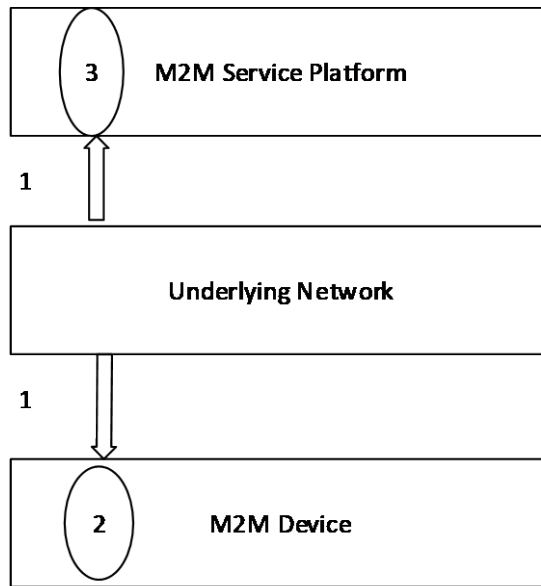
2900  
2901

**Figure 12-2 Normal Flow 1 of Data Traffic Management by Underlying Network Operator**

2902  
2903  
2904  
2905  
2906  
2907  
2908  
2909  
2910  
2911  
2912  
2913  
2914

Normal Flow 2:

1. The underlying mobile network sends the data traffic condition information to the M2M device as well as M2M service platform.
2. Upon receiving the information, the M2M device re-configures the application behavior, e.g. the interval extension of communication, by M2M service layer capability. The re-configuration profile may be statically stored or can be overwritten by control from the M2M service platform.
3. Upon receiving the information, the M2M service platform controls M2M data transmission accordingly in cooperation with M2M service application server described in step 1 to step 3 in normal flow 1.



2915

2916

Figure 12-3 Normal Flow 2 of Data Traffic Management by Underlying Network Operator

2917

### 12.2.7 Alternative Flow

2918

None

2919

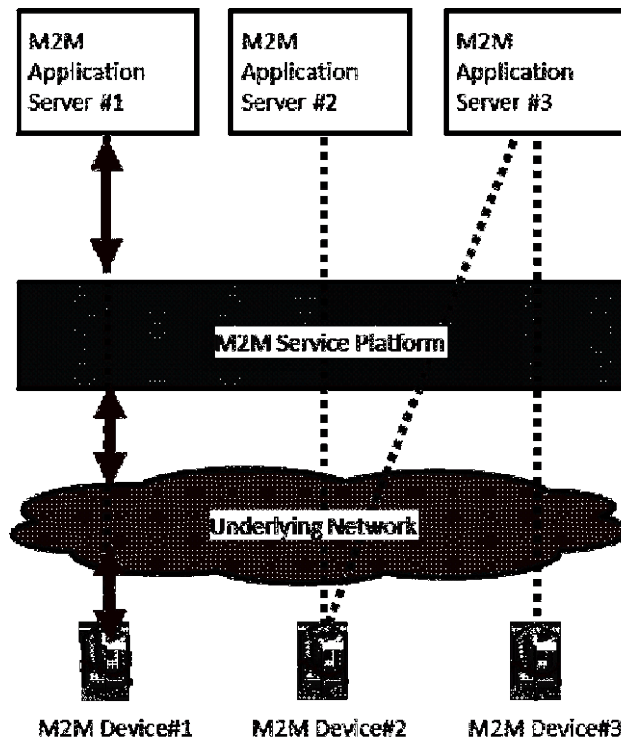
### 12.2.8 Post-conditions

2920

Not applicable

2921

### 12.2.9 High Level Illustration



2922

2923

Figure 12-4 High Level Illustration of Data Traffic Management by Underlying Network Operator

2924

## 2925 12.2.10 Potential Requirements

- 2926 1. The M2M service platform SHALL be able to receive the data traffic condition information from the  
2927 Underlying network and notify it to the M2M application server. The M2M application server  
2928 SHALL be able to control M2M data transmission based on the Underlying Network data traffic  
2929 condition.  
2930 2. The M2M service platform MAY SHALL be able to control M2M data transmission based on the  
2931 Underlying Network data traffic condition.  
2932 3. The M2M device SHALL be able to control M2M data transmission based on the Underlying  
2933 Network data traffic condition.  
2934 4. The M2M device SHALL control M2M application behavior implemented on top of M2M service  
2935 layer when the M2M device received notification regarding Underlying Network data traffic  
2936 condition from the Underlying Network.  
2937  
2938

## 2939 12.3 Optimized M2M interworking with mobile networks 2940 (Optimizing connectivity management parameters)

### 2941 12.3.1 Description

2942 Background on the use case and current state in 3GPP.  
2943 M2M Services, due to their nature (generally not involving human conversations), will most likely create much  
2944 lower Average Revenue Per User (ARPU) to an Underlying mobile Network than ordinary Human-to-Human  
2945 traffic.  
2946 Since M2M services, and in particular the oneM2M standard, relies on Underlying Networks (often mobile  
2947 networks) the success of M2M will inevitably depend on the fact that M2M traffic in the underlying network  
2948 will compete with human-to-human traffic; both, technically (use of resources) and economically (ARPU).  
2949 If M2M traffic in the Underlying Network would not be competitive with human-to-human traffic then a  
2950 significant sector of M2M services – i.e. those with low ARPU – could not be realized.  
2951 To enable economically feasible M2M business e.g. 3GPP seeks to reduce the costs – impact of traffic to the  
2952 network and the consumption of radio resources – that M2M devices will create for their networks.  
2953 E.g. already as early as in 2008 3GPP has created a first set of requirements on Machine Type  
2954 Communications (MTC) in [i.10]TS 22.368. These were finally approved in 3GPP Rel-10 (2010).  
2955 However, due to the (at the current point in time) low priority of M2M business for 3GPP Networks only  
2956 limited work has been done in 3GPP architecture, radio- and protocol groups until now.  
2957 E.g. only 2 out of 4 building blocks: MTCE-SDDTE (Small Data and Device Triggering Enhancements) and  
2958 MTCE-UEPCOP (UE Power Consumption Optimizations) have been prioritized by SA2 to be handled in  
2959 current 3GPP Rel-12.  
2960 SA2 (architecture) normative work can be found in [i.11] TS 23.682, the architecture study in [i.12] TR 23.887  
2961 We believe - and hope - that when in a few years 3GPP Rel-12/13 networks will be in operation then M2M  
2962 traffic will have a significant share in 3GPP networks. Therefore it is crucial that oneM2M expresses its needs  
2963 and potential impact to 3GPP now.  
2964 OneM2M, representing a high level of expertise in M2M business, needs to actively offer support to 3GPP and  
2965 other Underlying Network technologies.  
2966 Overview of the use case  
2967 Many mobile data applications are characterized by transmission of small data packets. Frequent small data  
2968 transmission may cause the network load by the mobile terminal changing frequently between idle and  
2969 connected state, if the terminal returns to idle mode soon after the data transmission. On the other hand, when  
2970 the mobile terminal is kept connected state unnecessarily (if normal operation involves only small data  
2971 transmission), it has impact on mobile terminal power consumption and radio resources consumption.  
2972 In order to reduce both, the control load related to the state transition and the consumption of radio resources,  
2973 the mobile network (e.g. 3GPP) needs to adjust configuration parameters (the connect keep timer, the radio  
2974 reception interval, etc.) based on the data transmission interval (frequent or infrequent) of the mobile terminal.  
2975 It is important for a mobile network to be informed about a change of data transmission interval of a M2M  
2976 device which is handled or monitored on service layer. However, such a change of data transmission interval is  
2977 not easily detected by the mobile network.

2978 This use case illustrates detection of a change of data transmission interval on service layer and notification to  
2979 the mobile network by interworking between the M2M service platform and the mobile network.

## 2980 12.3.2 Source

2981 oneM2M-REQ-2013-0231R02 Use Case on Mobile Network interworking-connectivity

## 2982 12.3.3 Actors

- 2983 • An M2M Application, hosted on an application server, provides services for creating flood warnings by  
2984 making use of (and communicating with) an M2M Device that is measuring water levels of a river.
  - 2985 ○ If the M2M Application detects that the water level becomes hazardous by the measurement data  
2986 of the M2M device it sends a request to change the communication mode (normal->abnormal) to  
2987 the M2M device (the water sensor), and sends current data transmission interval (frequent  
2988 communication) of the M2M device to the M2M service platform.
  - 2989 ○ The data transmission interval includes interval level (normal or frequent), interval value (5min,  
2990 30 min, 1h) etc.
- 2991 • The M2M service platform provided by the M2M service provider
  - 2992 ○ The M2M service platform has functions to get the data transmission interval from the application  
2993 server, analyse the information to detect the change of the transmission interval of the M2M  
2994 device and send the current data transmission interval of the M2M device to the mobile network  
2995 if any changes are discovered.
- 2996 • The mobile network provided by the mobile network operator
  - 2997 ○ The mobile network has functions to get the current data transmission interval of the M2M device  
2998 from the M2M service platform and inform the mobile network about it.
- 2999 • The M2M device
  - 3000 ○ The M2M device (the water level sensor) has functions to collect the measurement data and send it  
3001 the application server.
  - 3002 ○ The M2M device has two communication modes.
    - 3003 ▪ The normal communication mode (the water level is within a safe range): the data  
3004 transmission interval is infrequent (e.g. once an hour).
    - 3005 ▪ The abnormal communication mode (the water level exceeds the normal range (hazards)):  
3006 the data transmission interval is frequent (e.g. every minute).
  - 3007 ○ The M2M device has function to change into abnormal communication mode (the data  
3008 transmission interval is frequent) by a request to change the communication mode (normal-  
3009 >abnormal) from the application server.

## 3010 12.3.4 Pre-conditions

- 3011 • The water level of the river is safe. It means the data transmission interval of the M2M device (the sensor) is  
3012 infrequent (the communication mode is normal).
- 3013 • The configuration parameters of the mobile network about the M2M device
  - 3014 ○ The connection keep time :Short

## 3015 12.3.5 Triggers

3016 The water level of the river changes to hazardous through heavy rain. It means the data transmission interval  
3017 changes to frequent (the communication mode is abnormal) from normal (the communication mode is normal).

## 3018 12.3.6 Normal Flow

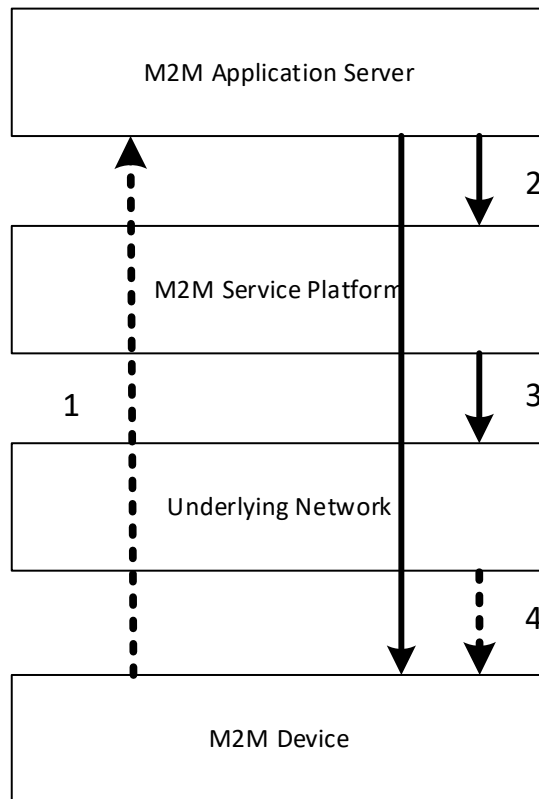


Figure 12-5 Normal Flow - Optimizing connectivity management parameters

1. The application server checks the measurement data from the M2M device (the water sensor).
2. If the application server detects that the water level becomes hazardous by the measurement data, sends a request to change the communication mode (normal->abnormal) to the M2M device (the water sensor), send current communication interval (frequent) of the M2M device to the M2M service platform.
3. The M2M service platform detects the change of the data transmission interval (infrequent->frequent) of the M2M device based on the current communication interval (frequent), and sends the current data transmission interval of the M2M device to the mobile network.
4. The mobile network adjusts configuration parameters of the mobile network about the M2M device based on the current data transmission interval of the M2M device if necessary.  
E.g. the configuration parameters of a 3GPP network may include the connection keep time (e.g. the inactivity timer, the idle (dormant) timer), the radio reception interval (e.g. the DRX (discontinuous reception) timer) etc.

### 12.3.7 Alternative Flow

None

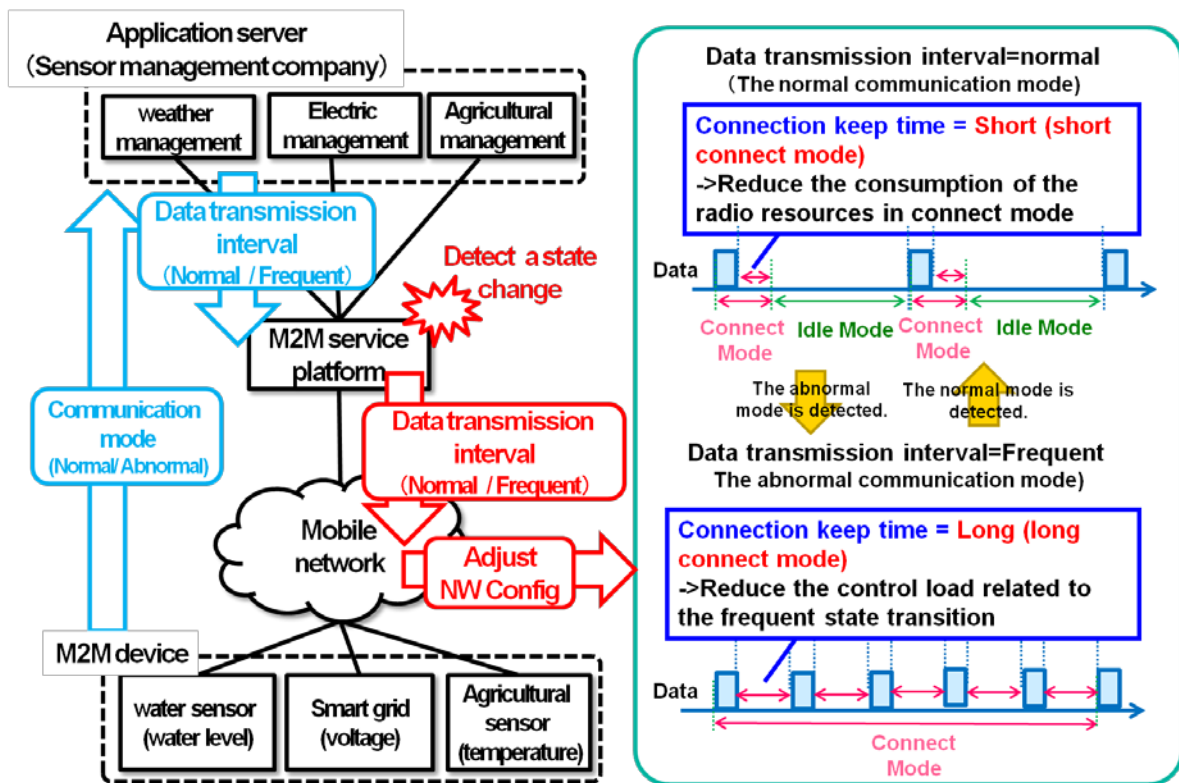
### 12.3.8 Post-conditions

The configuration parameters of the mobile network about the M2M device

- The connection keep time :Long

3040

### 12.3.9 High Level Illustration



3041

3042

3043

Figure 12-6 High Level Illustration - Optimizing connectivity management parameters

3044

### 12.3.10 Potential Requirements

3045

3046

3047

3048

3049

3050

3051

3052

3053

3054

3055

3056

3057

3058

3059

- The M2M service platform SHALL be able to provide the Underlying Network with information related to M2M devices that allows optimizations in the Underlying Network with regard to M2M traffic.
  - An example of such useful information to a cellular network is the current (or change of the) set of data transmission scheduling descriptors including interval times (5min, 30 min, 1h), time ranges (10pm-6pm) etc. of the M2M Device
  - How to utilize such information by the cellular network is the cellular operator implementation dependent and outside the scope of oneM2M.
- The M2M service platform MAY be able to compute the information with which the Underlying Network should be provided by analysing the information received from the M2M application before providing to the Underlying Network.

Note: The interface to convey such information to the Underlying Network will depend on the type (e.g. 3GPP, 3GPP2, fixed) of the Underlying Network.

3060

## 12.4 Optimized M2M interworking with mobile networks (Optimizing mobility management parameters)

3061

3062

### 12.4.1 Description

3063

3064

3065

3066

Background on the use case and current state in 3GPP M2M Services, due to their nature (generally not involving human conversations), will most likely create much lower Average Revenue Per User (ARPU) to an Underlying mobile Network than ordinary Human-to-Human traffic.



3067 Since M2M services, and in particular the oneM2M standard, relies on Underlying Networks (often mobile  
3068 networks) the success of M2M will inevitably depend on the fact that M2M traffic in the underlying network  
3069 will compete with human-to-human traffic; both, technically (use of resources) and economically (ARPU).  
3070 If M2M traffic in the Underlying Network would not be competitive with human-to-human traffic then a  
3071 significant sector of M2M services – i.e. those with low ARPU – could not be realized.  
3072 To enable economically feasible M2M business e.g. 3GPP seeks to reduce the costs – impact of traffic to the  
3073 network and the consumption of radio resources – that M2M devices will create for their networks.  
3074 E.g. already as early as in 2008 3GPP has created a first set of requirements on Machine Type  
3075 Communications (MTC) in [i.10] TS 22.368. These were finally approved in 3GPP Rel-10 (2010).  
3076 However, due to the (at the current point in time) low priority of M2M business for 3GPP Networks only  
3077 limited work has been done in 3GPP architecture, radio- and protocol groups until now.  
3078 E.g. only 2 out of 4 building blocks: MTCe-SDDTE (Small Data and Device Triggering Enhancements) and  
3079 MTCe-UEPCOP (UE Power Consumption Optimizations) have been prioritized by SA2 to be handled in  
3080 current 3GPP Rel-12.  
3081 SA2 (architecture) normative work can be found in [i.11] TS 23.682, the architecture study in [i.12] TR 23.887  
3082 We believe - and hope - that when in a few years 3GPP Rel-12/13 networks will be in operation then M2M  
3083 traffic will have a significant share in 3GPP networks. Therefore it is crucial that oneM2M expresses its needs  
3084 and potential impact to 3GPP now.  
3085 OneM2M, representing a high level of expertise in M2M business, needs to actively offer support to 3GPP and  
3086 other Underlying Network technologies.  
3087

#### 3088 Overview of the use case

3089 For optimizing traffic handling it is important for a mobile network to know about the mobility characteristics  
3090 (e.g. low mobility) of a M2M device to adjust configuration parameters (the traffic (paging) area, the location  
3091 registration interval, etc.). Such mobility characteristics are not easily detected by the mobile network itself but  
3092 depend on the M2M service and need to be provided by the service layer.

3093 Currently e.g. the assumption in 3GPP is that such mobility characteristics are relatively static and do not  
3094 change for the device. However in reality one and the same device (e.g. device in a car) may at one time be  
3095 stationary – low mobility characteristics when the car is parked – and at other times be mobile – high mobility  
3096 characteristics when driving.

3097 Therefore it becomes important for the mobile network to be informed about mobility characteristics (and  
3098 changes of it) of a M2M device. However such information can only be provided on service layer and not by  
3099 the mobile network itself.

3100 This use case illustrates detection of a change of mobility characteristics on service layer (through the M2M  
3101 Application) and notification (through the oneM2M Service Capabilities) to the mobile network by  
3102 interworking between the M2M service platform and the mobile network.  
3103

## 3104 12.4.2 Source

3105 oneM2M-REQ-2013-0137R02 Use Case on Mobile Network interworking-mobility

## 3106 12.4.3 Actors

- 3107 • The application server providing an application for a fleet management company  
3108 The application server has functions to get the mobility related M2M information from the M2M device  
3109 and send the current mobility characteristics based on the mobility related M2M information to the M2M  
3110 service platform.
- 3111 • The M2M service platform provided by the M2M service provider  
3112 The M2M service platform has functions to get the current mobility characteristics from the application  
3113 server, analyse the information to detect the change of the mobility characteristics of the M2M device  
3114 based on the current mobility characteristics and send the current mobility characteristics of the M2M  
3115 device to the mobile network if any changes are discovered.  
3116 The mobility characteristics include mobility status (high mobility, low mobility, no mobility), direction  
3117 and speed, etc.
- 3118 • The mobile (transport) network provided by the mobile network operator  
3119 The mobile network has functions to get the current mobility characteristics of the M2M device from the  
3120 M2M service platform and adjust the configuration parameters of the mobile network about the M2M  
3121 device based on the current mobility characteristics of the M2M device.  
3122 The configuration parameters of the mobile network include the traffic (paging) area, the location  
3123 registration interval, etc.
- 3124 • The M2M device

3125 The M2M device has functions to collect the mobility related M2M information from sensors within the  
 3126 vehicle and send it to the application server.  
 3127 The mobility related M2M information includes engine on/off, navigation system on/off, and GPS data etc.

3128 **12.4.4 Pre-conditions**

3129 An M2M Application, hosted on an application server, provides services for fleet management by making use  
 3130 of (and communicating with) an M2M Device that is mounted on a vehicle of the fleet.

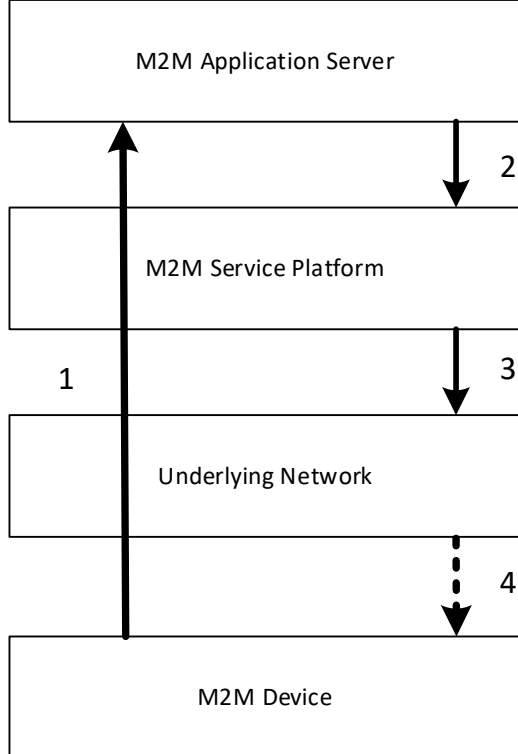
- 3131 • The vehicle is running on the road. It means the mobility characteristics of the M2M device (the  
 3132 vehicle) is high mobility (the engine is on)
- 3133 • The configuration parameters of the mobile network about the M2M device
  - 3134 ○ The traffic (paging) area: Wide
  - 3135 ○ The location registration interval: Short

3136 **12.4.5 Triggers**

3137 The vehicle stops at a parking lot. It means the mobility characteristics of the M2M device (the vehicle)  
 3138 changes from high mobility (the engine is on) to no mobility (the engine is off).

3139 **12.4.6 Normal Flow**

3140  
 3141



3142  
 3143 **Figure 12-7 Normal Flow - Optimizing mobility management parameters**

- 3144 1. The M2M device collects the mobility related M2M information (the engine is off) from sensors within  
 3145 the vehicle and sends it to the application server.
- 3146 2. The application server gets the mobility related M2M information of the M2M device (the vehicle) and  
 3147 sends the current mobility characteristics (high mobility) based on the mobility related M2M information  
 3148 to the M2M service platform.
- 3149 3. The M2M service platform detects the change of the mobility characteristics (high mobility->no mobility)  
 3150 of the M2M device based on the current mobility characteristics (high mobility), and sends the current  
 3151 mobility characteristics of the M2M device to the mobile network.  
 3152

4. The mobile network adjusts configuration parameters of the mobile network about the M2M device based on the current mobility characteristics of the M2M device if necessary.
  - The changed configuration parameters of the mobile network are the traffic area (Wide->Small), the location registration interval (Short->Long).
  - The mobile network may additionally need to adjust configuration parameters in the mobile M2M device.

### 12.4.7 Alternative Flow

None

### 12.4.8 Post-conditions

The configuration parameters of the mobile network about the M2M device

- The traffic (paging) area: Small
- The location registration interval: Long

### 12.4.9 High Level Illustration

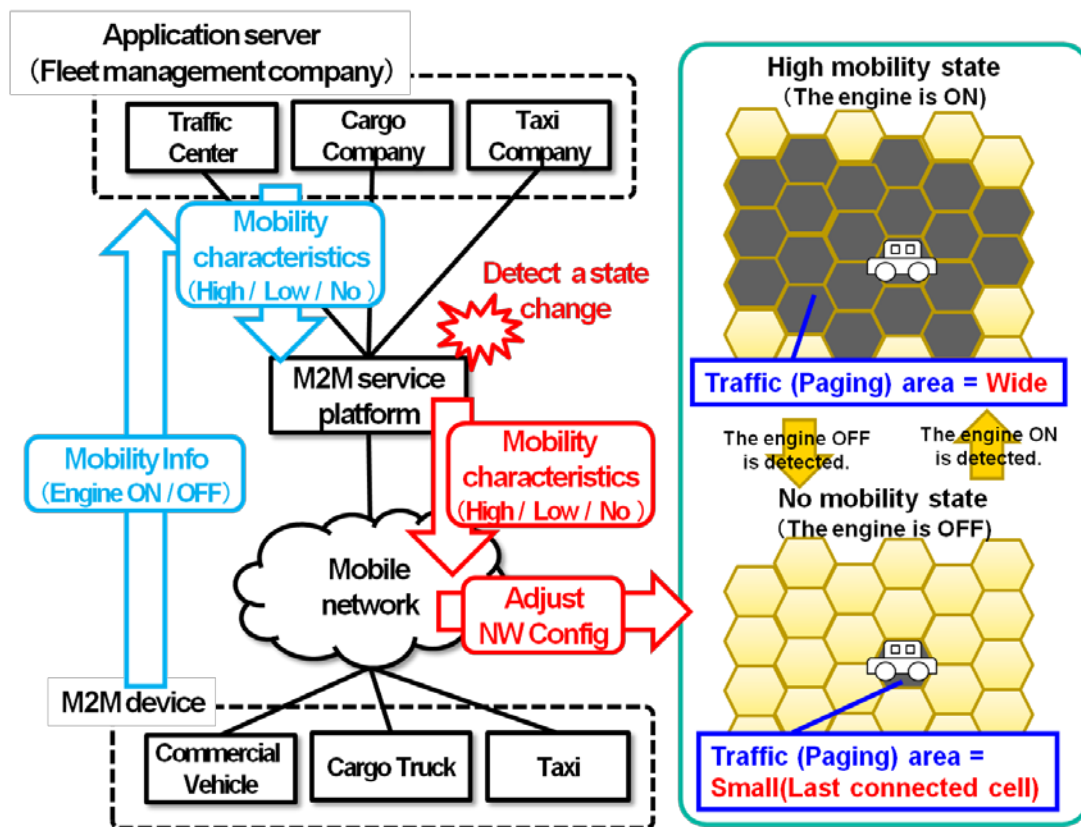


Figure 12-8 High Level Illustration - Optimizing mobility management parameters

### 12.4.10 Potential Requirements

1. The M2M service platform SHALL be able to provide the Underlying Network with information related to M2M devices that allows optimizations in the Underlying Network with regard to M2M traffic

An example of such useful information to a cellular network is the current (or change) of the mobility characteristics include moving range (e.g. high mobility, low mobility, no mobility, or speed range), moving direction and moving speed, etc. of the M2M device.

2. How to utilize such information by the cellular network is the cellular operator implementation dependent and outside the scope of oneM2M.

- 3180  
3181  
3182  
3183  
3184  
3185  
3186
3. The M2M service platform MAY be able to compute the information with which the Underlying Network should be provided by analysing the information received from the M2M application before providing to the Underlying Network.

Note: The interface to convey such information to the Underlying Network will depend on the type (e.g. 3GPP, 3GPP2, Fixed) of the Underlying Network.

## 12.5 Sleepy Nodes

### 12.5.1 Description

3189  
3190  
3191  
3192  
3193  
3194  
3195  
3196  
3197  
3198  
3199

Many e-Health applications involve the use of medical devices which may be connected to a monitoring service. The device user or the user's care providers may periodically need to observe measurements or interact with the device to optimize treatment.

Communications capabilities with multiple entities may be required. For example, communications may be needed between the device and a service/application that collects and analyses the monitored information. In another application communications to allow some control over the device. In one such case the communications may be between the device and the user's care provider(s) and in another case the communication may be with the device manufacturer. Short range communications capability that operates through other devices such as Smartphone or home gateway is assumed to conserve battery life.

One example of such a device is a diabetes management system that includes an insulin pump and a blood glucose monitor.

3200  
3201  
3202  
3203  
3204  
3205  
3206  
3207  
3208  
3209  
3210  
3211  
3212  
3213  
3214  
3215  
3216  
3217  
3218  
3219  
3220  
3221

An insulin pump is used to deliver the insulin. Two types of insulin are commonly used one is fast acting the other slow. The fast acting is usually administered in conjunction with a meal, while the slow acting is used throughout the day.

When and how often the blood glucose level monitor needs to take a reading varies with the daily routine as well as the user's condition.

The need to report the monitored information could vary from an instantaneous reading ordered by the user's care provider to a record of readings at varying intervals over different time periods.

Usually, the monitored information is stored on the device for a period of time before being periodically downloaded. In some cases, the data is sent to a monitoring service, which may perform analysis of the information in preparation for reporting to the user's care providers.

This device can automatically operate the above mentioned functions when needed. Programming of some of these functions can be varied depending on the condition of the user. Sometimes during a daily routine automated operation is preferred (e.g. while traveling or sleeping). Automation is more important for some device users, such as infants, which cannot operate the device manually.

Occasionally, there may be a need to download new firmware to a device to correct a software problem or provide new programming.

The proper functioning of the device is important to maintaining the user's health. The device needs to be operational when needed (i.e. reliable). Optimizing the devices battery life contributes to its reliable functioning. To maximize the life of the device's battery requires putting certain of its functions to sleep for different time intervals (i.e. sleep cycles) when not needed.

Sleep mode device handling is a fundamental issue/requirement for the M2M system. Although there are several requirements in this domain, currently there is no use case clearly addressing this functionality.

### 12.5.2 Source

3222  
3223  
3224

oneM2M-REQ-2013-0261R03 Sleepy Node Use Case

### 12.5.3 Actors

- Sleepy Node (SN)

3226  
3227  
3228  
3229  
3230  
3231  
3232  
3233

A device that spends a large amount of its lifetime disconnected from the network, mainly to save power, or just because it's not capable of storing the energy required for its reliable operation. The device wake up may be based on a variety of methods including but not restricted to: local physical interrupts or triggers, alarms, notifications, etc.

Sleepy node devices may own and host a set of resources that need to be made available to the other network participants as if it were a typical, always connected device. In some cases low-power, low-range communication technologies (e.g. ZigBee or Bluetooth) may be used to establish connections with relays

3234 or gateways capable of longer-range communication (e.g. the user's home Wi-Fi router or smartphone). In  
3235 this use case several devices used for medical treatment (e.g. insulin pump and blood glucose monitor)  
3236 embody sleepy node functionality.

3237  
3238 • **Medical Device Monitoring & Management Service (MDMMS)**

3239 This service periodically collects medical information from the user's monitoring device. Such a service  
3240 usually provides analysis of the device information for use by medical professionals (e.g. user's care  
3241 providers). This service can also initiate communication with the device (to send it a command, to re-  
3242 program it, to update its firmware, etc.). Additional services could be provided to other actors through the  
3243 collection and analysis of additional information such as device reachability, connection and  
3244 synchronization requirements, battery status, etc.

3245  
3246 • **Care Provider (CP)**

3247 Care Providers refers to medical professionals responsible for evaluating and directing treatment for an  
3248 illness or disease. In this use case the Care Providers are M2M Application Service Providers that interact  
3249 with the user's medical device. The Care Providers require access to the data provided by the device as  
3250 well as to applications and functions residing on the device.

3251  
3252 • **Medical Device Manufacturer (MDM)**

3253 The medical device manufacturer will occasionally require to access and control the device to, for  
3254 example, download a firmware update or to re-program the device.

3255 **12.5.4 Pre-conditions**

3256 In this use case the user (e.g. patient) is assumed to be wearing a medical device that operates as a Sleepy Node.  
3257 However, other similar use cases may involve a medical device that has been surgically implanted within the  
3258 user, which places an even higher degree of emphasis on its power conservation characteristics. The device has  
3259 been provisioned for communication using the oneM2M System and is capable of establishing a data  
3260 connection for communicating with the MDMMS.

3261 **12.5.5 Triggers**

3262 A variety of triggers might be associated with the overall use case:

- 3263 • Scheduled transfer of information from SN to MDMMS
- 3264 • Command from MDMMS to SN (initiated by CP)
- 3265 • Alarm condition at SN requiring interaction with MDMMS
- 3266 • Update of SN firmware (by MDMMS or MDM)
- 3267 • Status update or servicing of the SN (by CP, MDMMS or MDM)

3268 To be noted: triggers for device wake up are different than the use case triggers and may be based on a variety  
3269 of methods such as: local physical interrupts or triggers, alarms, notifications, etc. Communications between  
3270 SN and the MDMMS may be triggered by either entity.

3271 **12.5.6 Normal Flow**

3272 A. Initial setup of SN to MDMMS communications

- 3273 1. The device is first installed /powered up.
- 3274 2. Network connectivity with the oneM2M System will be established.
- 3275 3. Communications between SN and MDMMS are initiated by either entity, depending on individual  
3276 requirements. Device, capability, service, subscription, user, etc. information is exchanged.
- 3277 4. The SN and MDMMS may exchange SN specific information such (power cycles, allowable  
3278 communication wake-up triggers, etc.)
- 3279 5. The device may receive commands from the MDMMS.
- 3280 6. The device completes any received commands and communicates status as appropriate.
- 3281 7. The device returns to a sleep state.

3282 B. SN to MDMMS transfer of information

- 3283 1. The device wakes up from a sleep cycle. The wake up may occur based on any number of  
3284 asynchronous events.
- 3285 2. The device initiates communication with the MDMMS. Because the device has been in a sleep  
3286 condition that does not support any network connectivity, it is possible that a data connection with the  
3287 oneM2M System will need to be re-established.
- 3288 3. Once a data connection is established, the device transfers its accumulated information payload to  
3289 the MDMMS.

- 3290 4. The device may receive commands from the MDMMS that are either sent directly during the
- 3291 established communication session or have been sent previously and stored in an intermediate node.
- 3292 5. The device completes any received commands and communicates status as appropriate.
- 3293 6. The device returns to a sleep state.
- 3294 C. Command from MDMMS to SN
- 3295 1. Care Provider initiates command to the device (e.g. change in insulin delivery rate) via MDMMS.
- 3296 2. MDMMS may schedule delivery of the command based on any relevant scheduling information
- 3297 (such as service and application requirements, notification types, network congestion status, SN
- 3298 power cycle status, SN reachability, etc.). Several commands may be aggregated, ordered or queued
- 3299 and delivered to the SN or an intermediary node.
- 3300 3. Command(s) are delivered by the intermediary node or MDMMS to the SN after its wake up.
- 3301 4. The device completes any received commands and communicates status as appropriate.
- 3302 5. The device returns to a sleep state.
- 3303 D. Alarm condition at SN requiring interaction with MDMMS
- 3304 1. The device wakes up outside of its sleep cycle due to an alarm condition (e.g. blood glucose levels
- 3305 below a predetermined threshold).
- 3306 2. The device initiates communication with the MDMMS. Because the device has been in a sleep
- 3307 condition that does not support any network connectivity, it is possible that a data connection with the
- 3308 oneM2M System will need to be re-established.
- 3309 3. Once a data connection is established, the device communicates the alarm condition to the
- 3310 MDMMS.
- 3311 4. The device may receive commands from the MDMMS that are either sent directly during the
- 3312 established communication session or have been sent previously and stored in an intermediate node.
- 3313 5. The device completes any received commands and communicates status as appropriate, but also
- 3314 maintains the communication session until the alarm condition is cleared or otherwise resolved.
- 3315 6. The device returns to a sleep state.
- 3316 E. Update of SN firmware
- 3317 1. MDMMS is notified by MDM that the device firmware must be updated.
- 3318 2. MDMMS schedules the firmware update.
- 3319 3. The device wakes up and receives a notification that firmware update is requested. This may
- 3320 require additional action by the user (e.g. plugging the device into a power source during the update
- 3321 process) and by the MDMMS to establish a communication channel between the MDM and the
- 3322 device to perform the data transfer and/or execute the update process.
- 3323 4. The device returns to a sleep state.
- 3324 F. SN status update or servicing
- 3325 1. Various SN status and/or parameters (battery status, reachability state, etc.) are requested via
- 3326 MDMMS
- 3327 2. MDMMS notifies the SN.
- 3328 3. The device initiates communication with the MDMMS. Because the device has been in a sleep
- 3329 condition that does not support any network connectivity, it is possible that a data connection with the
- 3330 oneM2M System will need to be re-established.
- 3331 4. Upon device wake up
- 3332 G. The device returns to a sleep state

### 3333 12.5.7 Alternative Flow

3334 None

### 3335 12.5.8 Post-conditions

3336 In most cases, the SN will resume sleep as detailed in the flow clause, but the state of wakefulness is  
 3337 determined by other factors such as device, application, service or subscription requirements.

### 3338 12.5.9 High Level Illustration

3339 None

### 3340 12.5.10 Potential Requirements

3341 The following is a list of previously submitted requirements with impact on SN functionality, which is now re-  
 3342 submitted for consideration for this scenario.

3343 **Table 12-1**

Temp req. no.	Submitted req. number	Initial submitter	Requirement
SNR-001	HLR-118	Telecom Italia	The M2M System may be aware of the reachability state of the Applications.
SNR-002	HLR-024	Telecom Italia	The M2M System shall be able to support a variety of different M2M Devices/Gateways types, e.g. active M2M Devices and sleeping M2M Devices, upgradable M2M Devices/Gateways and not upgradable M2M Devices/Gateways.
SNR-003	HLR-055	Telecom Italia	The M2M System should support time synchronization. M2M Devices and M2M Gateways may support time synchronization. The level of accuracy and of security for the time synchronization can be system specific.
SNR-004	HLR-114	Telecom Italia	The M2M System shall support testing the connectivity towards a selected set of Applications at regular intervals provided the Applications support the function.
SNR-005	HLR-095	Fujitsu	The M2M System shall be able to support a mechanism for delaying notification of Connected Devices in the case of a congested communication network.
SNR-006	HLR-096	Fujitsu	The M2M System shall be able to support a mechanism to manage a remote access of information from other Connected Devices. When supported the M2M system shall be able to aggregate requests to perform the request depending on a given delay and/or category e.g. the M2M application does not have to connect in real time with the devices.
SNR-007	HLR-097	Telecom Italia	The M2M System may support a mechanism for delaying notifying a Connected Objects.
SNR-008	HLR-098	Telecom Italia	The M2M System may support a mechanism to manage a remote access of information from Applications and shall be able to aggregate requests and delay to perform the request depending on a given delay and/or category.
SNR-009	HLR-115	Telecom Italia	The Applications and their resources operational status shall be monitorable.
SNR-010	HLR-161	ALU, Huawei	The M2M System shall be capable of retrieving information related to the environment (e.g. battery, memory, current time) of a M2M Gateway or Device

## Informative annex to Potential Requirements

### Requirements TS content related to Sleepy Node functionality

#### OSR-002

The M2M system shall support communication means that can accommodate devices with constrained computing (e.g. small CPU, memory, battery) or communication capabilities (e.g. 2G wireless modem, certain WLAN node) as well as rich computing (e.g. large CPU, memory) or communication (e.g. 3/4G wireless modem, wireline) capabilities.

#### OSR-013

The M2M System shall be aware of the delay tolerance acceptable by the M2M Application and shall schedule the communication accordingly or request the underlying network to do it, based on policies criteria.

#### OSR-015

The M2M system shall support different communication patterns including infrequent communications, small data transfer, large file transfer, streamed communication.

#### MGR-001

M2M System shall support management and configuration of resource constrained devices.

### Other agreed requirements related to Sleepy Node functionality

#### (HLR-005)

The M2M System shall support M2M applications accessing the M2M system by means of a non-continuous connectivity.

#### (HLR-006)

The M2M System shall be able to manage communication towards a device which is not continuously reachable.

3369  
3370  
3371  
3372  
3373  
3374  
3375

**(HLR-047)**

The M2M System shall be able to manage the scheduling of network access and of messaging.

**(HLR-137)**

The M2M System shall provide the capability to notify M2M Applications of the availability of, and changes to, available M2M Application/management data on the M2M Device/Gateway, including changes to the M2M Area Network.



## 12.6 Collection of M2M System data

### 12.6.1 Description

M2M Service Providers have a need to provide the Application Service Providers with data and analysis related to the behavior of the M2M System as well as the service provider supplied components of the M2M System (e.g. Device Gateway) M2M Operators face two problems.

M2M Service Providers can utilize the methods of Big Data by collecting M2M System data for the behavior of the M2M System as well as data from M2M System components provided by the Service Provider.

In this scenario, the data is collected from M2M Gateways and Devices provided by the M2M Service Provider. The M2M System data that is collected from the M2M Devices and Gateways can be described as:

- M2M System Behavior
- Component Properties

**M2M System Behavior:** Data related to the operation of the M2M Applications within the M2M System. Types of data that is to be collected includes information related Messages transmittal and reception (e.g. bytes, response times, event time).

**Component Properties:** Data related to the Service Provider supplied components as the component is in use by the M2M System (e.g. location, speed of the component, other anonymous data).

With this data, the M2M Service Provide can provide:

1. Analysis of the data without knowledge of content of the Application's data.
2. Insights into the operation of the M2M Applications. For example, the M2M Service Provider can infer the "correct" state of the application or the network status changes, by the analysis of the data, and then trigger some kinds of optimization mechanisms.

### 12.6.2 Source

oneM2M-REQ-2013-0279R04 Collection of non-application data

### 12.6.3 Actors

- Front-end data-collection equipment (e.g. M2M Devices and Gateways) :
- Management Platform (e.g. M2M Service Provider's Platform)
- Monitor Centre (e.g. M2M Application's Platform)
- M2M System Data Collection Centre

### 12.6.4 Pre-conditions

None

### 12.6.5 Triggers

- Time trigger: collecting data at a specific time;
- Position trigger: collecting data when position changed;
- Behavior trigger: collecting data when certain behavior happened

### 12.6.6 Normal Flow

1. The M2M Device and Gateway collects M2M System data.
2. Once a trigger is activated, the M2M Devices and Gateway sends the M2M System data to the M2M System Data Collection Centre.

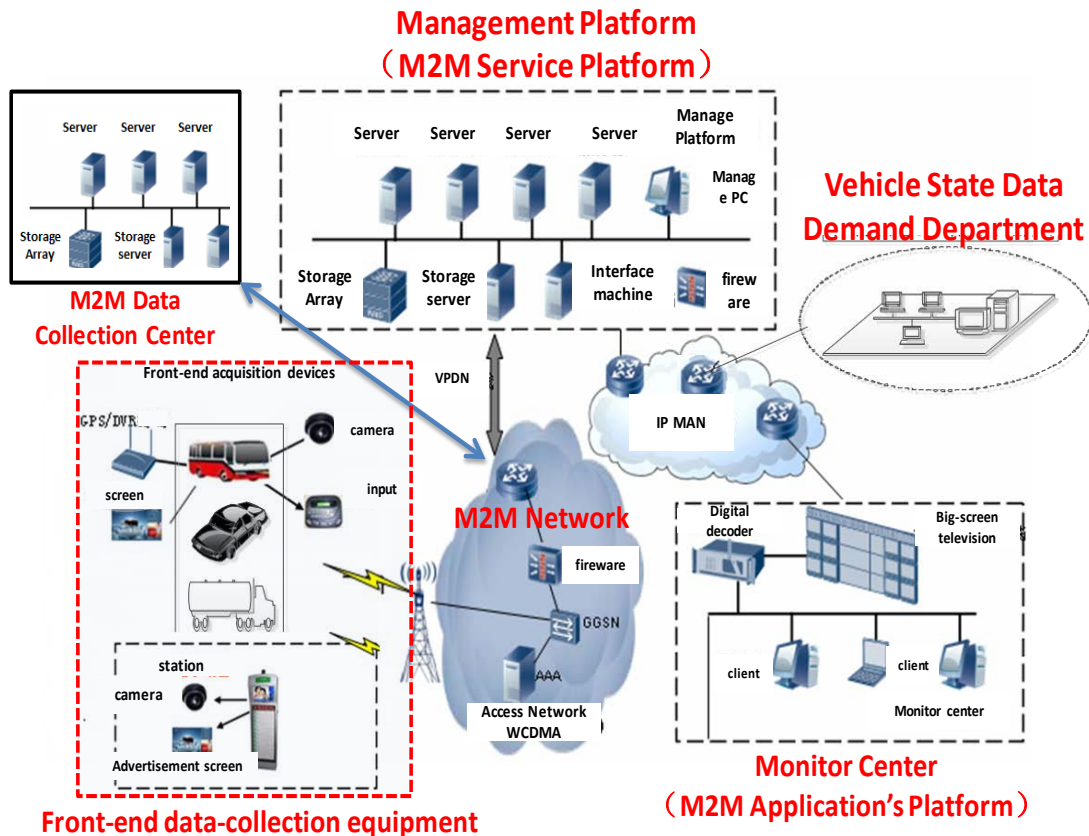
### 12.6.7 Alternative Flow

None

### 12.6.8 Post-conditions

Not applicable

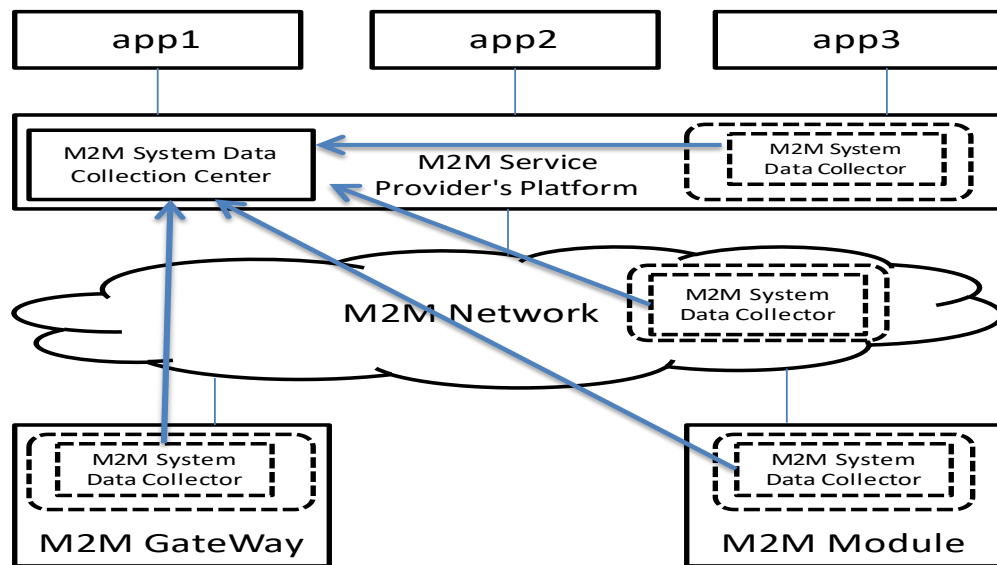
## 12.6.9 High Level Illustration



**Figure 12-9 Vehicle Operation Management System**

- Vehicle Operation Management System provide users a new telecommunications business with remote collection, transmission, storage, processing of the image and alarm signals.
- Front-End Data Collection Equipment include Front-End 3G camera, Electronic Station, Car DVR, costumed car GPS, WCDMA wireless routers and other equipment.
- Management Platform with business management function, include:
  - Forwarding, distribution, or storage of images
  - Linkage process of alarms
  - Management and maintenance of the vehicle status data.
- Monitor Centre: consists of TV wall, soft / hardware decoder, monitor software, etc.
- Vehicle State Data Demand Department: such as auto 4S shop, vehicle repair shop, vehicle management centre, automobile and parts manufacturers, government regulatory platform, etc.
- M2M System Data Collection Centre: use built-in data collectors resided in Network Equipment, M2M Platform, Costumed M2M Modules and Costumed M2M Terminal Devices to collect M2M System data.

## 12.6.10 Potential Requirements



**Figure 12-10 M2M System Data Collection Processing Flow**

1. M2M System should support M2M System data collection.

As illustrated in Figure 12.6.10 1, we suggest that M2M System data collector should reside in:

- M2M Service Providers' Platform
- M2M Network Equipment
- M2M Devices and Gateways
- M2M Communication Module

## 12.7 Leveraging Broadcasting/ Multicasting Capabilities of Underlying Networks

### 12.7.1 Description

This use case illustrates that an automotive telematics (Application) service provider XYZ Ltd. alerts vehicles around where a traffic accident has just happened. The alerted vehicles could go slow or go another route to prevent a second accident and to avoid the expected traffic jam.

In this case, the automotive telematics service provider XYZ Ltd. takes advantage of broadcasting/multicasting capability of underlying communication networks. Some kinds of communication networks (in particular, a mobile communication network) have the capability to broadcast/multicast a message in specific areas. Utilizing this capability, XYZ Ltd. can alert at once all the relevant vehicles within a specific region. This approach can avoid burst traffic in the communication network and provides a simple and cost-efficient way for XYZ Ltd. to implement this neighbourhood alerting mechanism.

Note: Ordinary unicast messaging mechanism is inadequate here. The alert messages shall be delivered in a timely manner to all the relevant vehicles within a specific region. XYZ Ltd. therefore needs to select the relevant vehicles that should receive the alert messages according to their current registered location (It needs continuous location management of vehicles). Moreover the underlying communication network has to route large number of unicast messages with very short delay.

However it is hard for XYZ Ltd. to utilize broadcasting/multicasting functionality of underlying networks directly which can vary with kinds of communication networks (e.g. 3GPP, 3GPP2, WiMAX or Wi-Fi). A oneM2M service provider ABC Corp. facilitates this interworking between XYZ Ltd. and a variety of communication network service providers (or operators). ABC Corp. exposes unified/standardized interfaces to utilize broadcasting (or multicasting) capability of communication networks. ABC Corp. authenticates the requester (=XYZ Ltd.), validates and authorizes the request, then calls the corresponding function of the appropriate communication networks.

Note: There are many other scenarios in which broadcasting/multicasting capability of underlying communication networks provides significant benefit in a M2M system. For example,

- Warning about a crime incident
  - When a security firm detects a break-in at a house, it sets off all neighbourhood burglar alarms and alerts the M2M Application on the subscribed users' cellular phones around there.
- Monitoring a water delivery system
  - When a water-supply corporation detects a burst of a water pipe, it remotely shuts off the water supply valves in that block, and alerts the M2M Application on the subscribed users' cellular phones around there.

The potential requirements in this contribution cover the above and all similar use cases, too.

## 12.7.2 Source

oneM2M-REQ-2013-0260R02 Leveraging Broadcasting - Multicasting Capability of Underlying Networks

## 12.7.3 Actors

- The automotive telematics service provider: XYZ Ltd.  
It provides automotive telematics service as a M2M application.
- The oneM2M service provider: ABC Corp.  
It provides a common platform to support diverse M2M applications and services.
- The communication network service providers (or operators): AA Wireless, BB Telecom and CC Mobile  
They operate communication networks.  
Some of them have the capability to broadcast/multicast a message in specific areas. The broadcasting/multicasting capability is available for external entities.
- The vehicles:  
They have communication capability as M2M devices, and have user interfaces (e.g. displays, audio speakers) or actuators to control driving.

Note: roles are distinct from actors. For example, the oneM2M service provider role may be performed by any organization that meets the necessary standardization requirements, including MNOs.

## 12.7.4 Pre-conditions

The vehicles are able to communicate in one or more communication networks.

## 12.7.5 Triggers

The automotive telematics service provider XYZ Ltd. detects a traffic accident.

How it detects the accident and captures details of the accident is out of scope of this use case.

## 12.7.6 Normal Flow

1. XYZ Ltd. estimates the location and impact of the accident to specify the area in which all the relevant vehicles should be alerted.
2. XYZ Ltd. requests oneM2M service provider ABC Corp. to alert subscribed vehicles in the specified area.
  - That request encapsulates the alert message (payload) and alert parameters (options).
    - The request contains the payload to be delivered to vehicles. It can contain for example the alert level (how serious and urgent), the location and time of the accident, and directions to the driver (e.g. go slow or change routes).
    - The request also defines targeted receivers of the message and specifies alert options. They can contain for example the area to be covered, the type of devices to be alerted, the option whether the alerting should be repeated, the repetition interval, and stopping conditions.
3. ABC Corp. receives the alert request from XYZ Ltd. It authenticates the requester (=XYZ Ltd.), validates and authorizes the request. When the request from XYZ Ltd. does not have alert parameters, ABC Corp. analyses the alert message to determine broadcast parameters. Then it chooses appropriate communication network service providers (or operators) to meet the alert request from XYZ Ltd.
4. ABC Corp. requests AA Wireless and CC Mobile to broadcast the alert message in the specified area.
  - That request encapsulates the alert message (payload) and broadcast parameters.
    - The alert message is the payload to be delivered to vehicles. The contents are the same as from ABC Corp. but the format and encoding of the message may be different from AA Wireless and CC Mobile.

- The broadcast parameters define targeted receivers of the message and specify broadcast options. They can contain for example the area to be covered, the type of devices to be alerted, the option whether the broadcast should be repeated, the repetition interval, and stopping conditions. The format of the parameters can be different between AA Wireless and CC Mobile.

ABC Corp. may need to cover a part of the broadcasting functions for some communication network service providers. For example, if CC Mobile does not have the functionality to repeat broadcasting periodically, ABC Corp. repeatedly requests CC Mobile to broadcast the message, in order to meet the request from XYZ Corp.

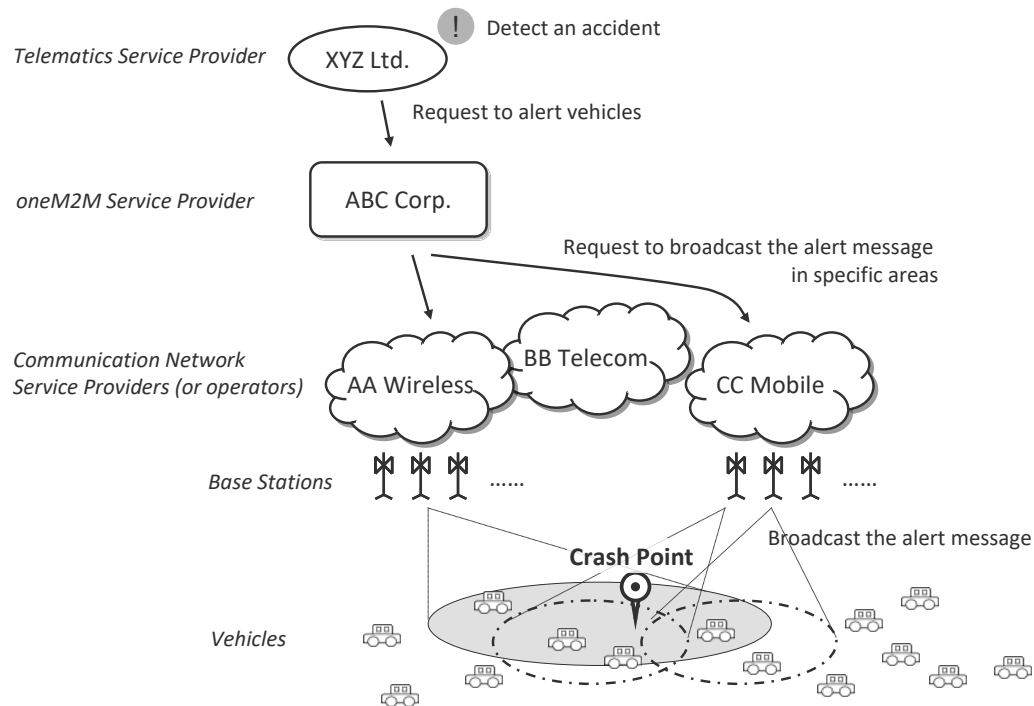
### 12.7.7 Alternative Flow

None

### 12.7.8 Post-conditions

The vehicles around where the traffic accident has just happened are properly alerted about the accident.

### 12.7.9 High Level Illustration



**Figure 12-11 High level illustration 1**

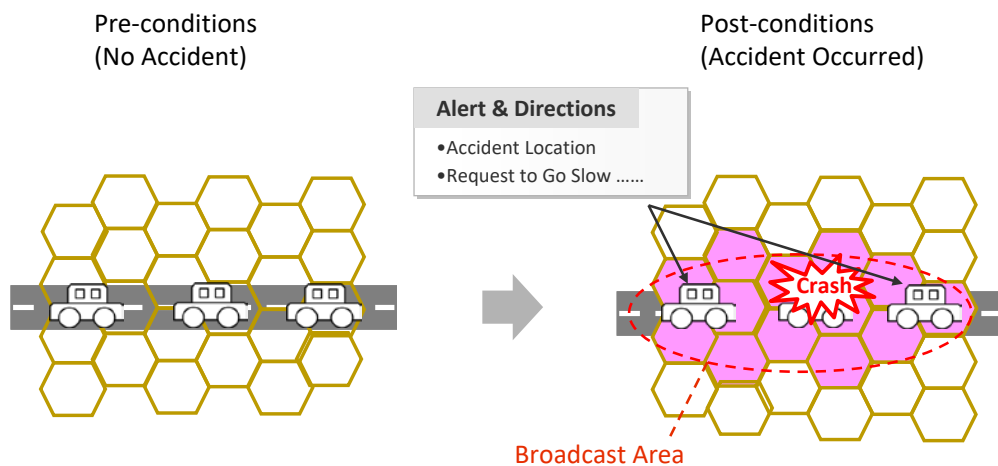


Figure 12-12 High Level Illustration 2

### 12.7.10 Potential Requirements

1. oneM2M System SHALL be able to leverage broadcasting and multicasting capability of Underlying Networks.
2. oneM2M System SHALL enable a M2M Application to request to broadcast/multicast a message in specific geographic areas.
  - That request SHALL encapsulate the message (payload) from the M2M Application, relevant parameters (options) and optionally credentials for authentication and authorization.
  - The M2M System SHALL support that request to be independent of the types of the Underlying Networks.
3. oneM2M System SHALL support mechanisms for Authentication, Authorization and Accounting of an M2M Application to request to broadcast/multicast a message.
  - oneM2M System SHALL authenticate the M2M Application.
  - oneM2M System SHALL validate and authorize the request.
  - oneM2M System SHALL support accounting on handling the request.
4. oneM2M System SHALL be able to select appropriate underlying networks to broadcast/multicast a message in specified geographic areas according to capability/functionality of those networks.
5. oneM2M System SHALL be able to receive information on broadcasting/multicasting capability/functionality of each underlying network.
6. oneM2M System SHALL be able to indicate towards the Underlying Network that a message needs to be broadcasted/multicast and to determine its broadcast parameters (or multicast parameters), e.g. the area to be covered, the type of devices to be alerted, the option whether the broadcast should be repeated, the repetition interval, and stopping conditions.
7. oneM2M System SHALL be able to analyse a message from a M2M Application to determine broadcast parameters.
8. Interfaces to address the above requirements SHALL be standardized by oneM2M.

Note: roles are distinct from actors. An actor may play one or more roles and the economic boundary conditions of a particular market will decide which role(s) will be played by a particular actor.

## 12.8 Leveraging Service Provisioning for Equipment with Built-in M2M Device

### 12.8.1 Description

Some industrial equipment is so complicatedly designed that it's difficult for users themselves to maintain, such as construction engineering equipment, air compressor, large medical instrument and so on. Vehicles with online service can also be seen as one kind of such equipment. Therefore, equipment vendors build back-end

applications to monitor and maintain them remotely. They also collect data from them for analysis in order to improve service level and product quality. We call such service provided by equipment providers as “equipment remote maintenance service”.

Equipment providers can integrate remote communication unit into equipment directly. But often, they get M2M device from other providers, which mainly provide remote communication capability. They embed one M2M device into one equipment.

More and more equipment begin to use mobile network to communicate with the back-end application because of the convenience and low-cost of the current mobile network. In this case, SIM Card or UIM Card should be put into the M2M device. epic [i.15] can be one of the best choices.

This contribution mainly focuses on M2M service provisioning in the above case. M2M service consists of the service provided by M2M service platform and network service provided by the mobile network. Therefore, full M2M service provisioning consists of M2M service provisioning and network service provisioning. The former is to allow M2M device to talk with M2M service platform. The latter is to make M2M device access mobile network.

M2M service platform is operated by M2M Service Providers (M2M SP). With M2M SP’s help, Equipment Providers don’t need to manage mobile-network specific identifiers, such as IMSI, MSISDN or MDN. They just use Equipment ID / Equipment Name and Device ID / Device Name to identify equipment and device. M2M Service Platform can hide the complexity of the underlying mobile network.

For devices managed by M2M Service platform, there are two kinds of M2M Service status. One is administrative status. The other is operational status. The former is to tell whether M2M Service has been allowed to be running by M2M SP for a device. “active” means it’s allowed. “de-active” means it’s not allowed. The latter is to tell whether M2M Service is available now for a device. “available” means it function correctly now. “unavailable” means it doesn’t function correctly now. For example, if related IMSI has been deactivated by MNO, M2M Service operational status of the device is unavailable.

For network identifiers, Network Service administrative status is to tell whether network service has been allowed to be running for a network identifier by MNO. “active” means it’s allowed. “de-active” means it’s not allowed.

## 12.8.2 Source

oneM2M-REQ-2013-0171R03 M2M Service Provisioning for Equipment with Built-in M2M Device

## 12.8.3 Actors

- Equipment Provider (EP)  
Vendors who make equipment with built-in remote communication capability, sell and install equipment, and provide equipment remote maintenance service
- Equipment User  
Customers who use equipment
- M2M Device Provider (M2M DP)  
Vendors who make M2M Device with built-in remote communication capability and other M2M service capability
- M2M Service Provider (M2M SP)  
Service provider who provide M2M service which including network service
- Mobile Network Operator (MNO)  
Service provider who provide mobile network service
- Equipment Provider Back-end Application (EPBA)  
One kind of M2M Applications by which EPs can monitor, control, and collect data from their equipment. It is normally located in EP’s office.
- M2M Service Platform (MSP)  
Platform which is operated by M2M SP and provides M2M Service
- Equipment  
It is made by EP, which can do some specific work in some specific areas, such as concrete machinery, hoisting machinery and air compressor.
- M2M Device  
Device embedded into equipment, which serves the function of communication between equipment and EPBA. It also talks with MSP to use M2M service.

## 12.8.4 Pre-conditions

Equipment User uses equipment remote maintenance service provided by EP.

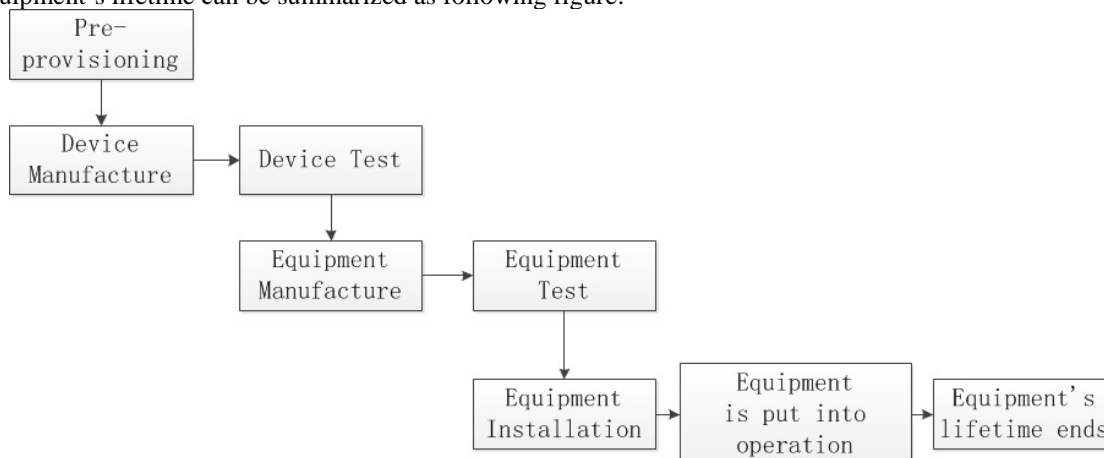
Equipment Provider uses M2M Service provided by M2M SP.  
M2M Service provided by M2M SP includes Network Service. That is to say, M2M service provider chooses which MNO's network to be used.

## 12.8.5 Triggers

None.

## 12.8.6 Normal Flow

Equipment's lifetime can be summarized as following figure:



**Figure 12-13 Equipment lifetime**

M2M service provisioning for equipment with built-in M2M device mainly consists of the following scenarios:

- Pre-provisioning Scenario
- Manufacture and Test Scenario
- Installation Scenario
- EP Suspends / Resumes / Stops Equipment Remote Maintenance Service Scenario
- M2M SP Suspends / Resumes M2M Service Scenario
- MNO Suspends / Resumes Network Service Scenario
- Replacing-device Scenario

### 1. Pre-provisioning Scenario

At first, M2M SP prepares a batch of SIM/UIM cards from MNOs and registers the information of these cards in MSP, such as ICCID, IMSI and so on

### 2. Manufacture and Test Scenario

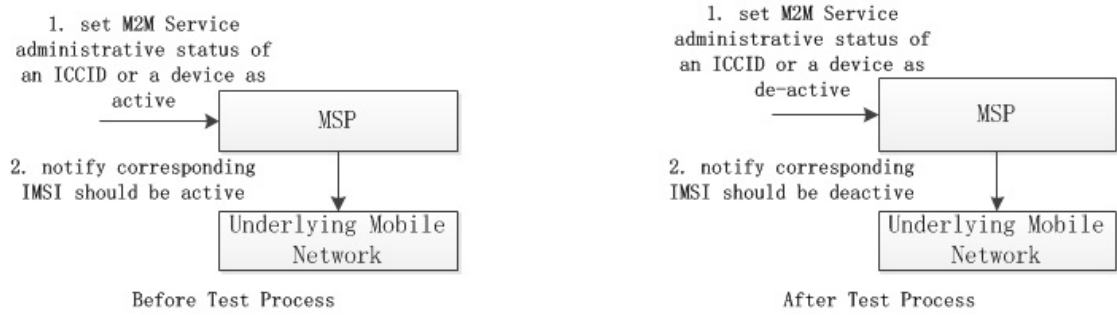
**Device Manufacture Phase:** M2M DP gets SIM/UIM card from M2M SP, and puts it into the module, and integrates the module into the device. Then, M2M DP configures the device ID parameter in device.

**Device Test Phase:** After that, M2M DP tests the device. Before and after the test, M2M DP or M2M SP sets M2M Service administrative status of specific ICCID as “active” or “de-active”, which allows MSP to talk with underlying mobile network to activate or deactivate the network service administrative status of the corresponding IMSI. In the test process, M2M Device reports its device ID and ICCID/IMSI to MSP. Thus, MSP knows such binding info.

**Equipment Manufacture Phase:** After that, EP gets the device and puts it into their equipment. Then, EP configures the equipment ID parameter in device.

**Equipment Test Phase:** EP also tests the equipment. Before and after the test, EP or M2M SP sets the M2M Service administrative status of specific device as “active” or “de-active”, which allows MSP to talk with underlying mobile network to activate or deactivate the network service administrative status of the corresponding IMSI. In the test process, Equipment reports its device ID and equipment ID to EPBA.

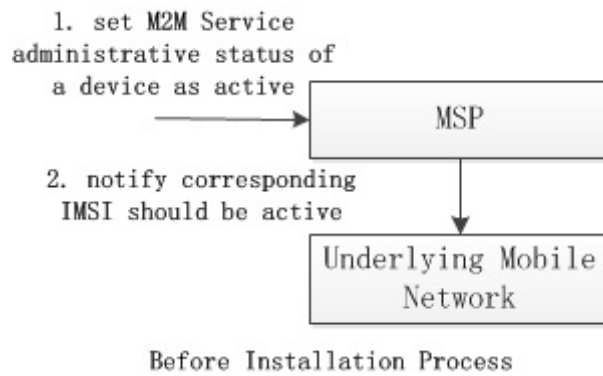




**Figure 12-14 Manufacture and Test Scenario**

**3. Installation Scenario**

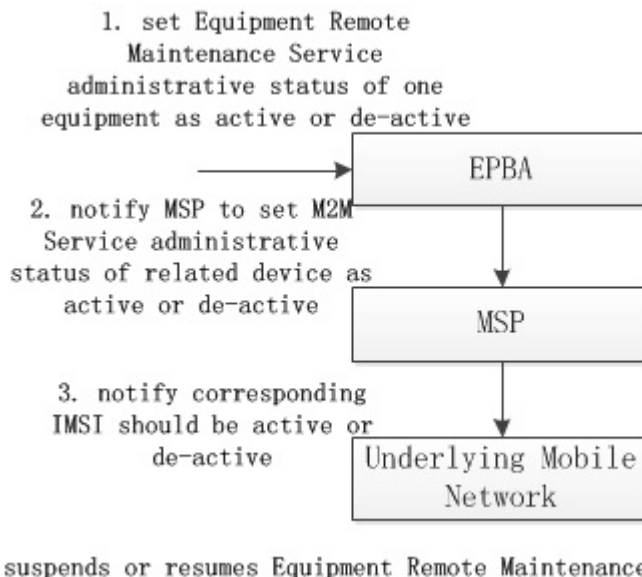
Before the installation, EP sets equipment remote maintenance service of specific equipment as “active”, and it talks with MSP to set M2M service administrative status of the corresponding device as “active”, and which also allows MSP to notify underlying mobile network to set network service administrative status of the corresponding IMSI as “active”. Then, EP continues to install the equipment. After that, the equipment can be put into operation.



**Figure 12-15 Installation Scenario**

**4. EP Suspends / Resumes / Stops Equipment Remote Maintenance Service Scenario**

EP may suspend, resume, or stop equipment remote maintenance service of specific equipment. For suspending and resuming scenario, EP sets equipment remote maintenance service of specific equipment as “de-active” or “active”, which may trigger MSP to set M2M service administrative status of the corresponding device as “de-active” or “active”, and which also may trigger MSP to notify underlying mobile network to set network administrative status of the corresponding IMSI as “de-active” or “active”. But, in some cases, the above administrative statuses don't correlation together. It's up to different business model and management policy.

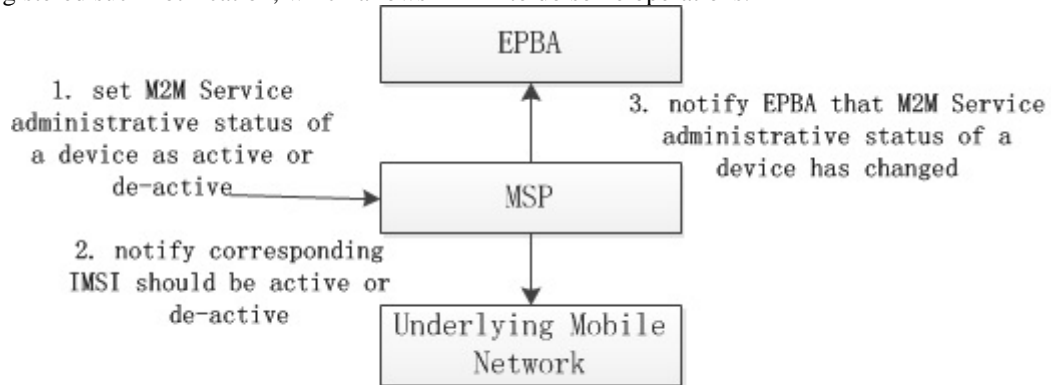


**Figure 12-16 EP Suspends / Resumes / Stops Equipment Remote Maintenance Service Scenario**

For stopping scenario, EP sets equipment remote maintenance service of specific equipment as “stopped”, which may trigger MSP to set M2M service administrative status of the corresponding device as “stopped”, and which also may trigger underlying mobile network to reclaim the corresponding IMSI.

#### 5. M2M SP Suspends / Resumes M2M Service Scenario

M2M SP may suspend or resume M2M service of specific device, which may let MSP talk with underlying mobile network to deactivate or activate network service administrative status of the corresponding IMSI. After that, MSP should notify EPBA of such M2M service administrative status change of the device if EPBA has registered such notification, which allows EPBA to do some operations.

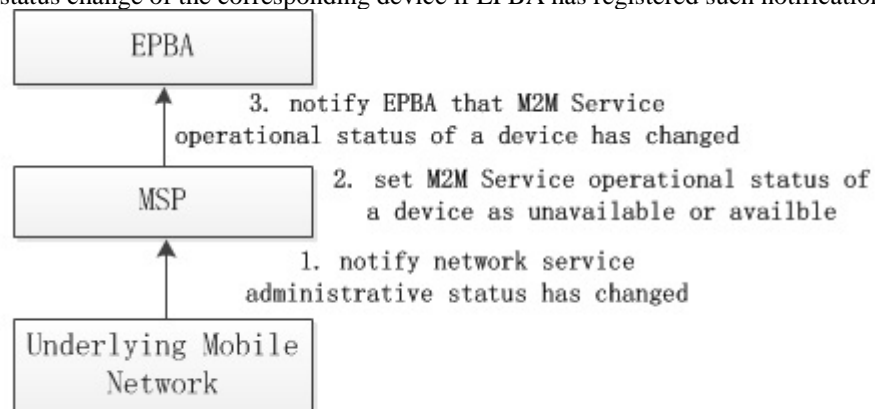


M2M SP Suspends / Resumes M2M Service Scenario

**Figure 12-17 SP Suspends / Resumes M2M Service Scenario**

#### 6. MNO Suspends / Resumes Network Service Scenario

MNO may suspend or resume network service of specific IMSI. If that happens, underlying mobile network may notify MSP the change of specific IMSI. Then, MSP may change the M2M service operational status of the corresponding device to “unavailable” or “available”. After that, MSP may also notify EPBA of the M2M service operational status change of the corresponding device if EPBA has registered such notification.



MNO Suspends / Resumes Network Service Scenario

**Figure 12-18 MNO Suspends / Resumes Network Service Scenario**

#### 7. Replacing-device Scenario

In some cases, EP may decide to replace bad device with new one in the equipment.

EP sets equipment remote maintenance service of specific equipment as “replaced”, which triggers MSP set M2M service administrative status of the corresponding device as “stopped”, which also may trigger MSP to notify underlying mobile network to reclaim the corresponding IMSI.

The following procedure is the same as the Equipment Manufacture Phase in Manufacture and Test Scenario

### 12.8.7 Alternative Flow

None

### 12.8.8 Post-conditions

Not applicable

## 12.8.9 High Level Illustration

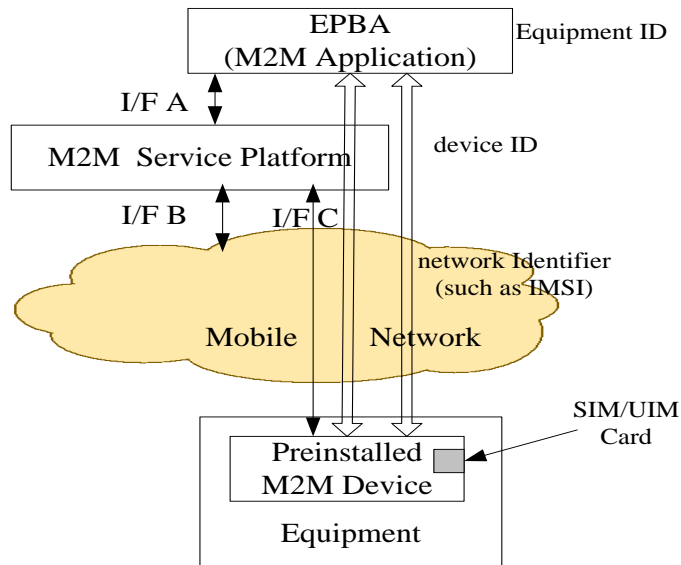


Figure 12-19 High Level Illustration

## Service Model

Equipment Provider (EP) provides equipment remote maintenance service to Equipment User. M2M SP provides M2M service to EP. MNO provides network service to M2M SP.

Equipment remote maintenance service consists of M2M service which is provided by M2M SP and other service provided by EP.

M2M service consists of network service which is provided by MNO and other service provided by M2M SP.

M2M service operational status will be de-active if network service administrative status is de-active.

## Entity Model

EPBA uses equipment ID to identify specific equipment.

EPBA and MSP uses device ID to identify specific device. MSP and underlying mobile network use network identifier such as IMSI, MSISDN, MDN or External id to identify specific user in its network.

One equipment has only one M2M device in it at one time. EP can replace old M2M device in equipment with new one.

One M2M device has only one SIM/UIM card in it.

## 12.8.10 Potential requirements

1. The M2M System shall identify and manage M2M Service status of devices.  
Note: There are two kinds of M2M Service status. One is administrative status. The other is operational status. The former is to tell whether M2M Service has been allowed to be running by M2M SP for a device. "active" means it's allowed. "de-active" means it's not allowed. The latter is to tell whether M2M Service is available now for a device. "available" means it function correctly now. "unavailable" means it doesn't function correctly now. For example, if related IMSI has been deactivated by MNO, M2M Service operational status of the device is unavailable.
2. The M2M System should identify Network Service administrative status of device-related network identifiers such as IMSI, MSISDN, MDN, or External id.
3. Note: Network Service administrative status is to tell whether network service has been allowed to be running for a network identifier by MNO. "active" means it's allowed. "de-active" means it's not allowed. The M2M System should support the correlation of service identifier of a device in service layer and related mobile network identifier such as IMSI, MSISDN, MDN, or External id in underlying network layer.  
Note: Different MNOs may expose different kinds of network identifiers to the M2M System. It's up to MNO.

4. System should notify underlying mobile network that Network Service administrative status of related mobile network identifier should be changed when M2M Service administrative status of a device changes if underlying mobile network can receive such notification and has subscribed such notification.
5. The M2M System shall notify M2M Application when M2M Service administrative status of a device changes if M2M Application has subscribed such notification. The M2M System should notify M2M Application when M2M Service operational status of a device changes if M2M Application has subscribed such notification.
6. The M2M System should change M2M Service operational status of the corresponding device to available or unavailable when it receives the notification from the underlying mobile network that Network Service administrative status of a mobile network identifier has changed to active or de-active, if the underlying mobile network can send such notification to the M2M System.
7. The M2M System should support M2M Application to activate or de-activate M2M Service administrative status of a device.

## 12.9 Semantics query for device discovery across M2M Service Providers

### 12.9.1 Description

This use case describes discovery of a device based on metadata of the device such as the type of device or its location. It is similar to the use case “Use Case on Devices, Virtual Devices and Things” in section 8.2 however in the present use case the discovery may be extended to the domains of different M2M service providers.

### 12.9.2 Source

REQ-2014-0005R01 Semantics query for device discovery across M2M Service Providers

### 12.9.3 Actors

- M2M Application Provider  
The M2M Application Provider provides an application which can employ a device that has already been installed and is operated by a different M2M Application Provider. However, the M2M Application Provider does not have any information (ID, URI, etc.) that can identify the device, the M2M service provider and the M2M Application Provider which the device belongs to.
- M2M Service Provider 1  
M2M Service Provider 1 is a service provider with whom the M2M Application Provider has a contractual relationship.
- M2M Service Provider 2  
M2M Service Provider 2 is a service provider with whom the M2M Application Provider does not have a contractual relationship. The M2M Service Infrastructure of M2M Service Provider 1 can communicate with the M2M Service Infrastructure of M2M Service Provider 2 via an inter-provider interface.
- The device which M2M Application Provider wants to employ is connected to M2M Service Provider 2.

### 12.9.4 Pre-conditions

An M2M Device (e.g. a surveillance camera in a public space, a thermometer for agriculture in a field, etc.) has been installed and is operated in the domain of M2M Service Provider 2. The M2M Application Provider has found the device in the real world (in the public space, the agriculture field, etc.) and wants to make use of the device within his application. The M2M Application Provider, however, does not have any information (ID, URI, etc.) that can identify the device. Further, the M2M Application Provider does not know which M2M Service Provider the device belongs to. The M2M Application Provider has a contractual relationship with M2M Service Provider 1. M2M Service Providers 1 and 2 have databases that contain information on their devices. The databases include location information (where each device is currently located) and the device type.

## 12.9.5 Triggers

Using a suitable interface (e.g. a web-page) of the M2M Application the M2M Application Provider creates a request for using the device. The request contains location information about the device and possibly a device type.

## 12.9.6 Normal Flow

0. The M2M Application launches a query within the domain of M2M Service Provider 1 to find and identify the device. The query is invoked with location information on the device and information on the device type.
1. The database of M2M Service Provider 1 is searched whether the requested device is connected to his domain or not.
2. If the requested device is connected to M2M Service Provider 1, M2M Service Provider 1 returns to the M2M Application the information to identify the device (ID, URI, etc.) and terms of use for the device.
3. If the requested device is not connected to M2M Service Provider 1 then M2M Service Provider 1 forwards the query to other M2M Service Providers to which M2M Service Provider 1 has an inter-provider system interface. Forwarding may depend on whether some criteria of the query are known to be supported / not supported by a certain Service Provider (e.g. if it is known that the devices of a Service Provider only operate in a certain geographical region and the query looks for a device in a different region).
4. The query is executed in the domains of the other M2M Service Providers.
5. If the requested device is connected to M2M Service Provider 2 then M2M Service Provider 2 returns to M2M Service Provider 1 the information to identify the device (ID, URI, etc.) and terms of use for the device.
6. M2M Service Provider 1 returns to M2M Application Provider the information to identify the device (ID, URI, etc.) and terms of use.

## 12.9.7 Alternative Flow

None

## 12.9.8 Post-conditions

M2M Application Provider can start to employ the device on the basis of the terms of use sent by M2M Service Provider 1.

## 12.9.9 High Level Illustration

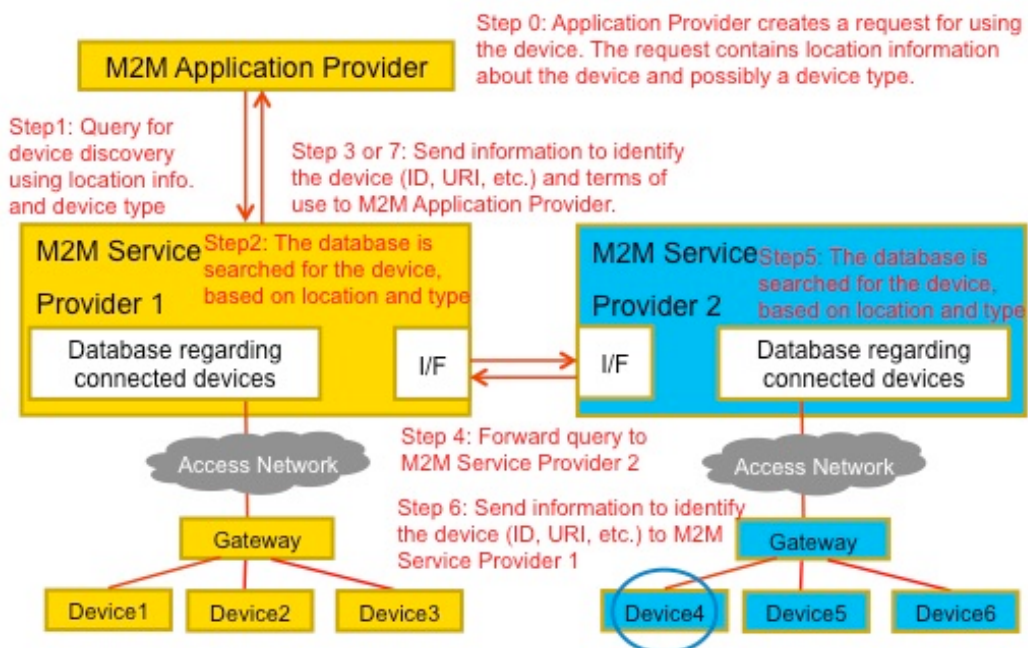


Figure 12-20 High Level Illustration of Semantics discovery across M2M Service Providers

## 12.9.10 Potential Requirements

The following requirements extend the requirement SMR-004 from section 6.3.2 (Semantic Requirements) of [i.14]:

SMR-004: The M2M System shall provide capabilities to discover M2M Resources based on semantic descriptions.

1. The M2M System shall provide a capability to an M2M Application to search (semantic query) within the domain of the application's M2M Service Provider to discover M2M Devices, Virtual Devices and Things on the basis of their semantic descriptions and meta-data such as device location or a device type.
2. The M2M System shall provide a capability to a M2M Service Provider to automatically forward such a semantic query via standardized inter-provider interfaces to the domains of other M2M Service providers in order to extend the search to these domains.

Note: Based on Service Provider's policies forwarding can depend on whether some criteria of the query are known to be supported / not supported by a certain Service Provider (e.g. if it is known that the devices of a Service Provider only operate in a certain geographical region and the query looks for a device in a different region).

If M2M Devices, Virtual Devices and Things that match the criteria are found within the domain of a M2M Service Provider to which the semantic query had been forwarded then the search results may be returned via standardized inter-provider interfaces to the domain of the M2M Service Provider that had forwarded the query. The search result shall contain sufficient information to identify the device and the term of use for the device.

3. The M2M System shall provide the capability to return to the M2M Application that had issued the semantic query the results of the query from the M2M Service Provider's domain and from M2M Service Provider domains to which the query had been forwarded.

The supported formats for semantic queries shall be described in the oneM2M standard.

## 12.10 Underlying network service activation and deactivation

### 12.10.1 Description

- Background of the use case

Currently, for flexible M2M service deployments and low network service subscription cost, some underlying network operators have developed their private network service activation and deactivation APIs and opened them to M2M application providers. The M2M systems may need to support reusing the network service activation and deactivation capability provided by underlying network via transforming these network APIs and opening for M2M applications.

- Overview of the use case

In the M2M device, a network service module (e.g. SIM card) will be embedded to support the network communication. For some potential requirements, the network service module need be activated or deactivated by remote or local M2M applications via M2M platform.

In the context of this use case, an *active network service module* means that the network service module enables the M2M device to send / receive M2M traffic. An *inactive network service module* does not allow the M2M device to send / receive M2M traffic, however the service module, together with the M2M device, is capable to exchange signalling with M2M platform according to network operator's policy.

The network entity of underlying network can activate/deactivate network service module according to network policy and network service activation/deactivation request.

The following scenarios are given to show above requirements.

- Factory acceptance test

During the factory acceptance test of the M2M device, the network service module need be activated for M2M service testing. After the test, the network service module need be deactivated for saving the network subscription cost.

- Starting usage

When the M2M device are sold and the user starts to use it, the network service module need be activated to support the M2M service. The network service module may be activated via M2M platform by local M2M applications in the case that the local M2M applications detects the M2M device in use or by remote M2M applications in the case that the user requests the M2M application server to active the M2M device.

- Abandon

When the M2M device is abandoned by user, the network service of the M2M device need to be deactivated for reducing network service subscription cost. In this case, the network service module will be deactivated via M2M platform by remote M2M applications.

- Lost

When the M2M device is lost or stolen, the network service of the M2M device need be deactivated for reducing network service subscription cost. In this case, the network service module will be deactivated via M2M platform by remote M2M applications.

- Abused

When the M2M device is misused by user (e.g. used for certain forbidden services), the remote M2M application server intends to stop providing M2M service and deactivate the network service of target M2M device via M2M platform.

Similarly, if a M2M device is used outside a specific geographic area in which the M2M device is supposed to operate (e.g. a vending machine is removed from its assigned place) then a location enabled M2M device may deactivate the network service module.

## 12.10.2 Source

REQ-2014-0446R02 Underlying network service activation and deactivation use case

## 12.10.3 Actors

- Underlying network operator
- M2M service provider
- M2M Application server (operated by a M2M Application Service provider)
- M2M platform (operated by the M2M service provider)
- M2M device (containing a network service module)
- Network service module (operated by the Underlying network operator)

## 12.10.4 Pre-conditions

- The mobile network operator opens the service interface, i.e. network API, for remote activation and deactivation of underlying network service.

## 12.10.5 Triggers

The following triggers could initiate exchange of information.

Trigger A:

The M2M application on M2M device initiates the activation request. In this case, the M2M device is in use, and the M2M application intends to activate / deactivate the network service of the corresponding M2M device via an M2M platform.

(Note that even if the network service of the M2M device is deactivated, the M2M device may still be able to connect to target M2M platform according to the policy of network operator. )

Trigger B:

The M2M application server initiates the activation/deactivation request. In this case, the M2M application intends to activate / deactivate the network service of the target M2M device via M2M platform.

## 12.10.6 Normal Flow

### Trigger A:

When the M2M device is in first use, network service activation request will be triggered by local M2M application on M2M device (Trigger A).

1. The M2M application on M2M device initiates the activation request to M2M platform.
2. The M2M platform uses the network service activation API provided by the underlying network operator to active the network service module of the corresponding M2M device and feedback the activation information.

### Trigger B:

When the user intends to reuse the M2M device, network service activation request will be triggered by remote M2M application, and when the M2M device is misused by users, network service deactivation request will be triggered by remote M2M application. (Trigger B).

1. The M2M application server initiates the activation/deactivation request to M2M platform.

- The M2M platform uses the network service activation/deactivation API provided by the underlying network operator to activate/deactivate the network service module of target M2M device and feedback the activation/deactivation information to the M2M application server.

### 12.10.7 Alternative Flow

None.

### 12.10.8 Post-conditions

**Trigger A:**

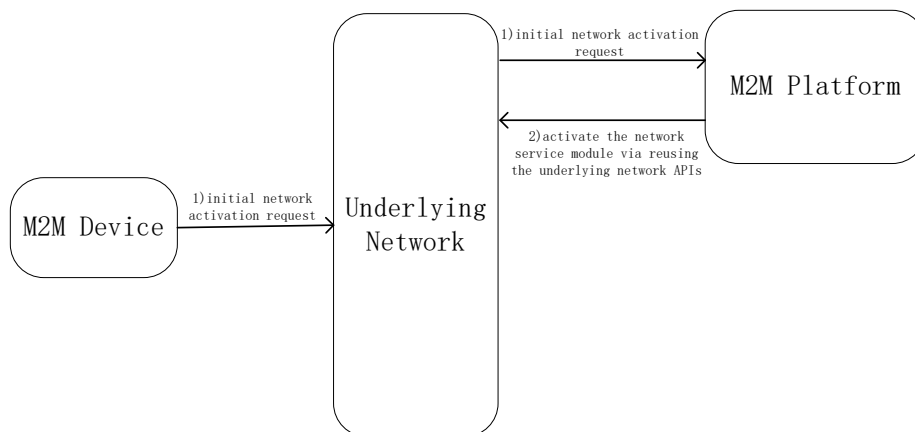
The M2M device can send / receive M2M traffic if the network service module is activated successfully according to network activation request.

**Trigger B:**

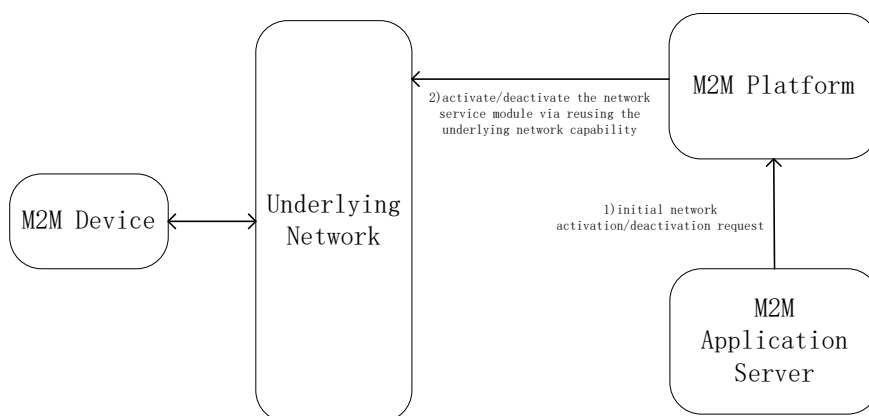
The M2M device cannot send / receive M2M traffic but may be able to exchange signalling with M2M platform if the network service module is deactivated successfully according to network deactivation request.

### 12.10.9 High Level Illustration

Fig. 11-22 and Fig. 11-23 describe the normal flow of this use case for Trigger A and Trigger 2 from high level aspect.



**Figure 12-21 - Normal flow description for Trigger A**



**Figure 12-22 - Normal flow description for Trigger B**

### 12.10.10 Potential requirements

- The M2M systems shall support the capability of reusing the network service activation and deactivation capability in underlying network via Mcn reference point.



## 12.11 On-demand data collection for factories

- void -

**Note:** This use case can be found in TR-0018 [i.18].

Source: REQ-2014-0487R03: A use case for industry: On-demand data collection for factories

## 12.12 Smart Irrigation System

### 12.12.1 Description

The use case describes a smart irrigation system in which all the valves and sensors deployed around the farmland are centrally controlled and managed by Irrigation Administration Centre. The sensors include temperature, humidity, illumination and soil moisture level. The Irrigation Administration Centre collects data from those sensors and decides if it's time to irrigate the farmland. Because the soil condition and the plant are different depend on the area of the farmland. The timing of the irrigation may be different. According to the pre-configured policies, and the Irrigation Administration Centre decides which valves to open, which valves to close as well as how much the valve opens to irrigate the farmland.

### 12.12.2 Source

REQ-2015-0528R03 Use case on transactions (Smart Irrigation System).

### 12.12.3 Actors

- Irrigation Administration Centre (IAC): The application that analyses the data collected by sensors and control the valves to irrigate the farmland.
- Smart Irrigation Service Provider: The Smart Irrigation Service Provider provides special sensors and valves to implement irrigation system. The Smart Irrigation Service Providers also own the database on the policies of how to irrigate certain plant based on the data collected by sensors. The Smart Irrigation Service Provider helps the customer of its system to deploy the irrigation system which includes the deployment of gateways, sensors and valves into the farmland. Prepare the channel and pipes to let the water flow to every corner of the farmland. The installation and configuration of the Irrigation Administration Centre. And make sure the system is working fine before the finishing of its service.
- M2M Service Provider: The M2M Service Provider provides M2M platform, M2M Gateway and standard ways to connect devices with each other. The Smart Irrigation Service Provider subscribes the service provided by M2M Service Provider to deploy its own service.
- Farmer: The customer that purchases the service from Smart Irrigation Service Provider. After the installation of the Smart Irrigation System, the farmer will no longer worry about the irrigation of its farmland.
- Sensors and Valves: Sensors and Valves deployed by Smart Irrigation Service Provider. The Valves are connected by channels or pipes. The sensors are scattered around the farmland include temperature sensor, humidity sensor, light sensor, soil moisture sensor.
- Channels and Pipes: Channels and pipes are jointly connected by valves from the source of the water to every corner of the farmland. Channels are half closed and may be overflowed if the water cannot be released in time. Pipes are closed and have standard pressure limit. If the downstream valve cannot be opened in time, may cause irregular pipe pressure which may result in fall of the junction valve or leak of water.
- M2M Gateway: M2M Gateways are deployed by M2M Service Provider to connect with sensors and valves around the farmland. M2M Gateway collects data from sensors and reports the data to M2M Platform. M2M Gateway also distribute control message from M2M Platform to valves.
- M2M Platform: M2M Platform is deployed by M2M Service Provider. It stores sensor data and valve conditions which are read or written by Irrigation Administration Centre application.

### 12.12.4 Pre-conditions

The subscription relationships between farmer, Smart Irrigation Service Provider, M2M Service Provider are carefully contracted.

Channels and Pipes are connected with valves from the source of water to every corner of the farmland.

Sensors are scattered around the farmland and connected with gateway and finally connected with the M2M Platform.

Irrigation Administration Centre is registered with M2M Platform and can successfully read or write sensor and valve state data.

To irrigate one part of the farmland, it may need to open several valves at the same time or in a certain order. If failed to do so, it may cause water overflow of the channel or irregular pressure of the water pipes. This may then result in unexpected irrigation or water leak.

### 12.12.5 Triggers

Based on the sensors data read by the Irrigation Administration Centre, the Irrigation Administration Centre decides to irrigate one part of the farmland.

### 12.12.6 Normal Flow

- 1) IAC reads sensors data from M2M Platform of Area\_A of the farmland.
- 2) IAC detects that according to current condition, Area\_A needs to be irrigated half an hour later.
- 3) IAC detects that to irrigate Area\_A, Valve\_1, Valve\_3 and Valve\_7 need to be opened at the same time. Valve\_1 needs to be opened to 10%, Valve\_3 needs to be opened to 50% and Valve\_7 needs to be opened to 100%.
- 4) IAC then sends request to M2M Platform to indicate to switch the valves to corresponding percentage in half an hour.
- 5) Valve\_1, Valve\_3 and Valve\_7 responded with success information immediately.
- 6) Valve\_1, Valve\_3 and Valve\_7 adjusted its open percentage after half an hour. Irrigation starts.
- 7) IAC detects that according to current condition, the water in Area\_A would be sufficient.
- 8) IAC then sends request to M2M Platform to indicate to switch the valves off in 5 min.
- 9) Valve\_1, Valve\_3 and Valve\_7 responded with success information immediately.
- 10) Valve\_1, Valve\_3 and Valve\_7 is shut off in 5 min. Irrigation stopped.

### 12.12.7 Alternative flow

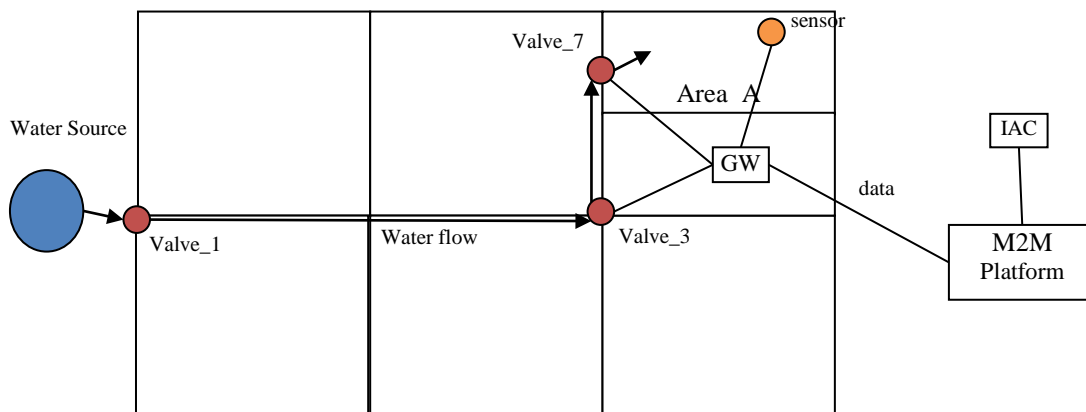
The alternative flow is about the scenario that something error happened during the operation of the valves.

- 1) IAC reads sensors data from M2M Platform of Area\_A of the farmland.
- 2) IAC detects that according to current condition, Area\_A needs to be irrigated half an hour later.
- 3) IAC detects that to irrigate Area\_A, Valve\_1, Valve\_3 and Valve\_7 need to be opened at the same time. Valve\_1 needs to be opened to 10%, Valve\_3 needs to be opened to 50% and Valve\_7 needs to be opened to 100%.
- 4) IAC then sends request to M2M Platform to indicate to switch the valves to corresponding percentage in half an hour.
- 5) Valve\_1 and Valve\_7 responded with success information immediately but Valve\_3 responded with a failure.
- 6) IAC requests to Valve\_1 and Valve\_7 the cancellation of the operation.
- 7) Valve\_1 and Valve\_7 responded the success cancellation.
- 8) Irrigation failed, the IAC will try some time later again for the irrigation.

### 12.12.8 Post-conditions

None

### 12.12.9 High Level Illustration



**Figure 12-23 Smart Irrigation System**

## 12.12.10 Potential requirements

1. The oneM2M system shall support distributed transactions to multiple devices or applications where the transaction includes the characteristics of atomicity, consistency, isolation and durability.
2. The oneM2M system shall support the completion of distributed transactions to multiple devices or applications while maintaining the order of the operations and performing the transaction within a given time frame.

## 12.13 Group Registration Management

### 12.13.1 Description

A user's smart phone hosts several workout tracking applications and several home automation applications. The workout tracking applications were provided with the user's gym membership. When in the gym, the workout applications are used to reserve and monitor the availability of workout equipment (e.g., treadmills) and track the user's workout performance. While at home, the workout tracking applications are used to track the user's workout performance.

The home automation application are used to control smart devices in the home while the user is at home or on the road.

When the user is at home, both the workout and home automation applications register with the user's home automation gateway so that they can communicate with smart devices and workout equipment in the home. While on the road, the home automation applications register with an M2M Server that can be used to monitor and control devices in the home via the home automation gateway. The workout applications also register with the M2M Server and take advantage of a location tracking service that the M2M Server offers. The location tracking service will be used by the workout application to detect when the host devices enters a gym.

Upon entering the gym, the workout applications register with an M2M Gateway that is owned by the gym. The geographical availability of new services triggers the workout applications to search for a new service layer and a registration to a new service layer.

### 12.13.2 Source

REQ-2015-0561 Use case group registration

### 12.13.3 Actors

- Workout Applications
- Home Automation Applications
- Home Gateway
- Gym Gateway
- M2M Server

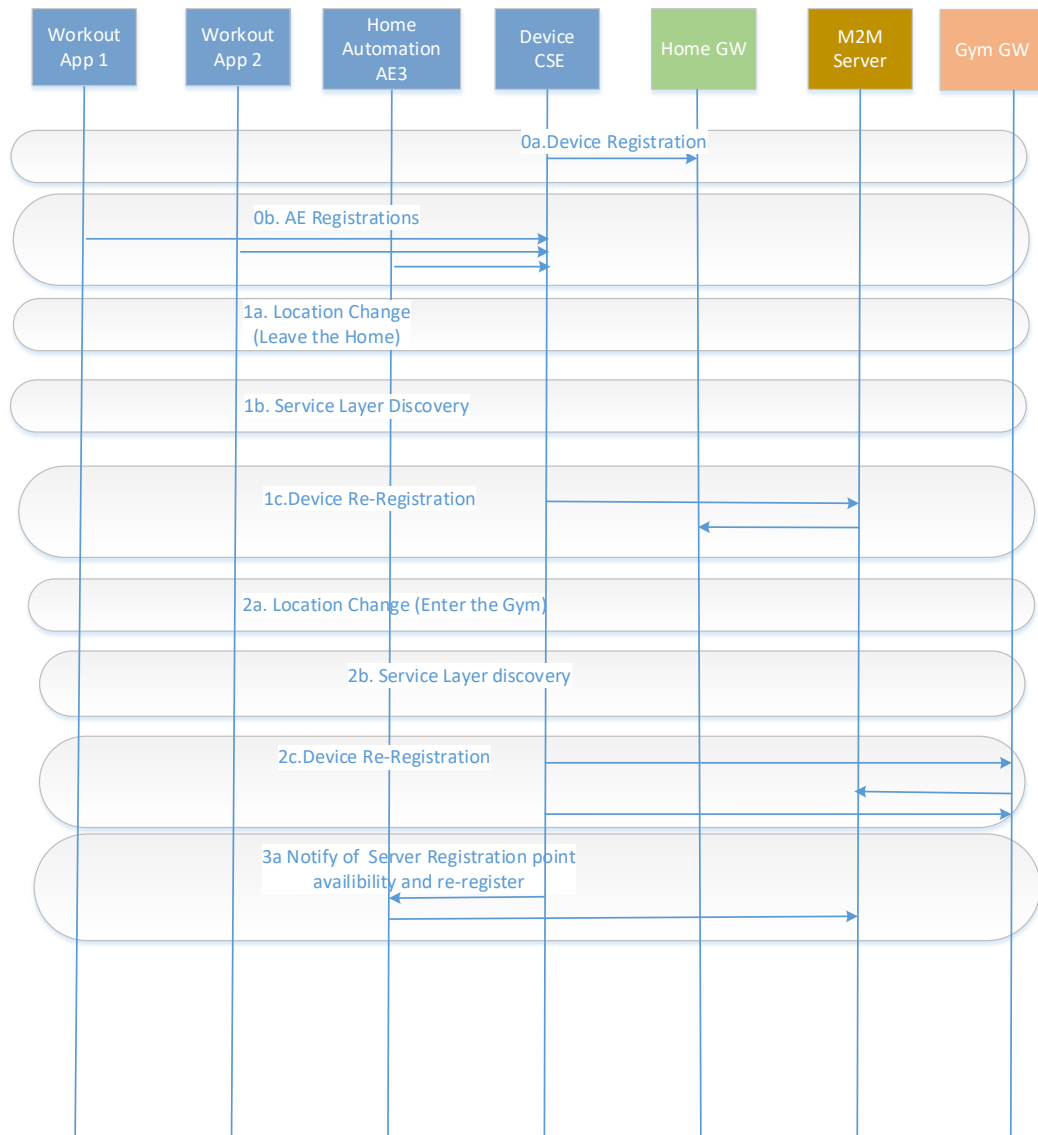
### 12.13.4 Pre-conditions

The Home GW is registered with the M2M Server

### 12.13.5 Triggers

Location change

### 12.13.6 Normal Flow



**Figure 12-24 Group Registration Management**

- 0a. The Device is registered with the home GW (i.e. via Wi-Fi).
- 0b. The workout and home automation applications AEs are registered with the ASN-CSE
- 1a. The user leaves the home, thus losing its network connection to the Home Gateway.
- 1b. The device (smart phone) performs service discovery and determines that the M2M Server can be reached (i.e. via cellular).
- 1c. The device registers with the M2M Server (i.e. via cellular).
- 2a. The user enters the gym.
- 2b. The device performs service layer discovery and determines the availability of the gym as registration point. Alternatively M2M Server notifies the device of the new registration point available at the gym. The cellular connection continues to be available.
- 2c. The device re-registers at Gym Gateway (e.g. via Wi-Fi) and announces the workout applications AE1 and AE2. The device does not announce applications which cannot be serviced by the gym gateway (e.g. home automation AE3)
- 3. The device notifies the home automation application AE3 of the availability of the M2M Server as registration point and AE3 re-registers directly with the M2M Server

## 12.13.7 Alternative flow

Depiction of alternative flows is not relevant

## 12.13.8 Post-conditions

The workout applications (AE1 and AE2) are being serviced by the Gym Gateway via a Wi-Fi connection. The home automation applications (AE3) is now registered to the M2M Server via a cellular connection.

## 12.13.9 High Level Illustration

See high level flow

## 12.13.10 Potential requirements

1. The oneM2M System shall provide the capability to notify a device hosting a group of applications that it should perform discovery when alternative registration points are available (e.g., via different underlying networks) based on the service requirements of each of the applications hosted.
2. The oneM2M System shall provide the capability to register applications in group or independently, based on their service requirements.

## 12.14 Multicast using group

### 12.14.1 Description

In the smart metering scenario, meters are reporting their collected data to the server in a predefined frequency. If it is decided to change the frequency, the server will have to change the policy to every meter by unicast manner. It's preferred that the system may utilize the broadcast or multicast mechanism to send out the configuration message to all the eligible devices at one time to save the network resources.

### 12.14.2 Source

REQ-2015-0557R01-Use Case multicast using group

### 12.14.3 Actors

- Metering Company: The Company that provides metering service to collect metering data from all the meters deployed across the city.
- M2M SP Platform: The platform provided by the M2M Service Provider to collect metering data from all meters.
- Meter: The meter device that is equipped with a wireless or wired network capability that connects with the M2M SP Platform to report their metering data.

### 12.14.4 Pre-conditions

The Metering Company and M2M Service Provider has signed contract about delivering the M2M Service. The Metering Company deploys Meters with pre-configuration on the frequency of reporting the data. The Meters connect and register with the M2M SP Platform and periodically reports metering data.

### 12.14.5 Triggers

The Metering Company decided to change the report frequency.

### 12.14.6 Normal Flow

1. The Metering Company creates a group on the M2M SP Platform and include all the meters as group members.

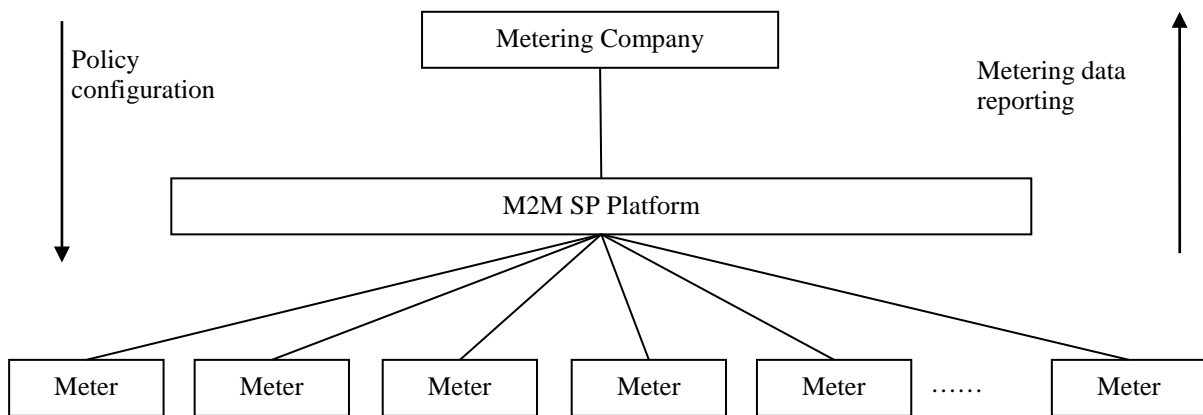
2. After the successful creation of group, the Metering Company then sends a policy configuration message to all meters through the group.
3. The M2M SP Platform determines if the connection of the meters supports broadcast/ multicast.
4. The M2M SP Platform then makes the best use of the broadcast/ multicast mechanism to fan out configuration messages.
5. After the receiving of the policies, meters start to report the metering data using the new frequency.

### 12.14.7 Alternative flow

None

### 12.14.8 Post-conditions

### 12.14.9 High Level Illustration



**Figure 12-25 Multicast using group**

### 12.14.10 Potential requirements

1. The oneM2M System shall be able to select an appropriate Underlying Network to broadcast or multicast data depending on the network's broadcast/multicast support and the connectivity supported by the targeted group of M2M Devices/Gateways.[OSR-052]
2. The M2M System shall be capable of collecting asynchronous responses pertaining to the broadcasted messages.

## 12.15 Access control using group

### 12.15.1 Description

The Parking Management System of the building is in charge of collecting the number of the available parking slot by the sensor that was set above each slot. The Parking Management System publishes the information on the M2M Platform for vehicles which is destined to the building to acquire. However, the information is only disclosed to vehicles that has proper access rights. The Parking Management System uses a group to organize the vehicles that has the correct access rights.

### 12.15.2 Source

REQ-2015-0556R01-Use Case access control using group

### 12.15.3 Actors

- **Parking Management System:** The Parking Management System uses the M2M SP to host its parking slot reservation service. The Parking Management System reports the available number of parking slots to the M2M platform for vehicles to acquire.
- **M2M SP:** The M2M Service Provider provides M2M platform as well as the connection between the platform, vehicles and the Parking Management System.
- **Vehicle:** The Vehicle acquires the available parking slot number of the building and decides if to reserve one from the Parking Management System or choose another nearby parking area.

### 12.15.4 Pre-conditions

The Parking Management System, the M2M SP and the Vehicles have established business relationship with each other.

Some Vehicles has been authorized by the Parking Management System to read the available parking slot information while some others are not.

The Parking Management System created a group on the platform of the M2M SP to organize all the Vehicles that are authorized.

### 12.15.5 Triggers

One Vehicle attempts to acquire the available parking slot number from the platform.

### 12.15.6 Normal Flow

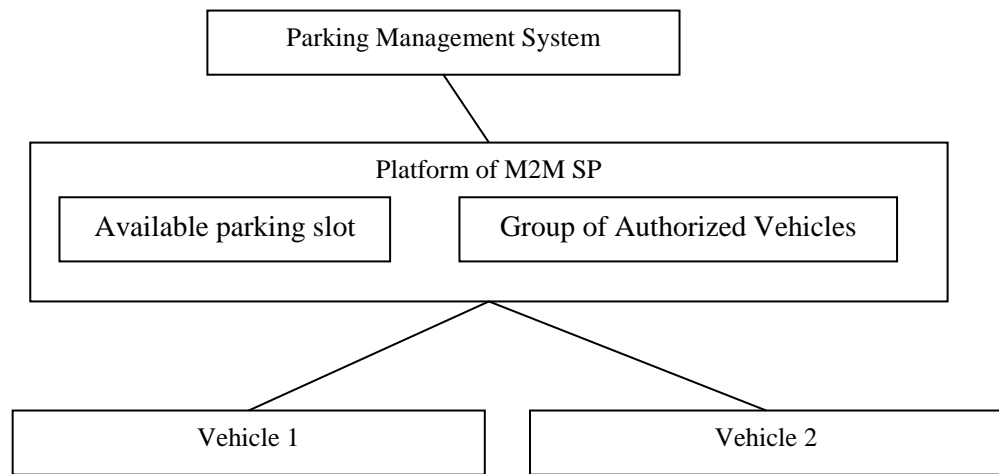
1. The Vehicle that is destined to the building acquires the available parking slot from the platform.
2. The platform inspects if the Vehicle is among the group that is authorized to retrieve such information.
3. The platform finds that the Vehicle is a member of the group.
4. The platform responds back the information to the Vehicle.

### 12.15.7 Alternative flow

1. The Vehicle that is destined to the building acquires the available parking slot from the platform.
2. The platform inspects if the Vehicle is among the group that is authorized to retrieve such information.
3. The platform finds that the Vehicle is not a member of the group.
4. The platform rejects the acquire attempt from the Vehicle.

## 12.15.8 Post-conditions

## 12.15.9 High Level Illustration



**Figure 12-26 Access control using group**

## 12.15.10 Potential requirements

1. The M2M System shall support grouping of M2M applications that have the same access control rights towards specific resources, so that access control can be performed by validating if the M2M application is a member of certain group.

## 12.16 Personal data management mechanism based on user's privacy preference

### 12.16.1 Description

Because the data collected by the M2M platforms may include personal information or sensitive information of data providers, the access to such data should be controlled appropriately. This use case shows the data management mechanism based on data provider's privacy preferences, which is developed as a PPM (Privacy Policy Manager). Because access from application service providers to the collected data at M2M service platform is controlled based on the privacy preferences that are configured by the data providers, unnecessary and unwanted access to the collected data is blocked appropriately.

### 12.16.2 Source

REQ-2015-0576-Use case of PPM

### 12.16.3 Actors

- Front-end data-collection equipment (M2M devices): This actor collects various kinds of data and sends the data to a management platform. The collected data may include sensitive or privacy information of data providers.
- Management platform (M2M Service Provider's Platform): The management platform stores the data collected by M2M devices. This also has authorization function that manages the access control to the stored data.



- **Data provider:** A data provider is a user of services from application service providers. The user subscribes services, and the management platform starts to collect data related to the user and its services. In case that a service requires personal information of a user, such data are collected by the management platform. So the user becomes the data provider. The data that are provided by the data provider may include sensitive or private information. The data provider can configure his/her privacy preference for the collected personal data. If the data provider would not like to permit the application service provider to collect or access specific kinds of data, the data provider can configure the privacy preference of the service to control the data collection or access. The management platform control the data collection from the M2M devices and the data access from the application service providers to the collected personal data based on the privacy preferences.
- **PPM:** A PPM function manages privacy preferences of the data providers. The data providers configure their privacy preferences while subscribing application services. The application service providers present the data providers which kinds of data are collected and used by the application service, and the data providers configure their privacy preferences to give access permissions to several kinds of collected data. Although an application service provider may use many kinds of data from a data provider, the data provider can permit the subset of listed data by configuring the privacy preference for its application service. A PPM function also has mechanism to record the usage of the collected data. When application service providers access to the collected data from data providers, its accesses are logged to the PPM. If the data providers would like to refer the past usage of their personal data, they can check it by accessing the PPM. The data provider can request the application service providers to delete the collected data based on the record of access log.
- **Application service providers:** This actor provides many kinds of services to service users. In case the application service providers use the data stored in the management platform, they access to the data via authorization function. Because this function provides access control to the data, the function asks a PPM and decides whether the application service provider has access permission to the accessing data or not.

#### 12.16.4 Pre-conditions

None

#### 12.16.5 Triggers

- **Service subscribing trigger:** configuring privacy preference of data providers for each service
- **Data collection trigger:** collecting data at M2M modules
- **Data access trigger:** accessing collected data from application service providers
- **Data usage reference trigger:** referring usage of collected data from application service providers
- **Data deletion trigger:** requesting deletion of accessed and stored data in application service providers

#### 12.16.6 Normal Flow

The following normal flow is described based on a figure in High Level Illustration (XX.X.9).

- a) **Configuration of privacy preference by data provider**
  1. When a user starts to subscribe a service of application service provider, the user checks the privacy policy of service. The privacy policy explains what kinds of data will be accessed to provide the service. If the user permits the application service provider to access the collected data by M2M management platform, the user becomes the data provider.
  2. The data provider can select the kinds of data that the application service provider can use by using the PPM. If the data provider would not like to permit the application service provider to access specific kinds of data, the data provider can configure the privacy preference to enable this situation. In other words, because this access permission can be defined item by item, the data provider can restricts the access to the part of collected data.
- b) **M2M data collection**
  1. The M2M Service Provider's platform collects data related to the data providers by using M2M devices. In this phase, unwanted and unused data are not collected by configuring privacy preference in PPM appropriately.

- c) M2M data access from application service providers
  1. When application service providers access to the collected data in M2M Data, they access M2M Service Provider's Platform. The authorization function in the platform controls access to the M2M Data based on the privacy preference stored in the PPM. The authorization function retrieves privacy preference to the target data from the PPM.
  2. If the access is permitted, the target data are transferred to the application service provider. If the access is not permitted, the authorization function responds to the application service provider with the notification of access denied with reasons.
- d) Traceability of personal data usage
  1. When the application service providers access to the collected data in M2M Data, all the access and its result (access permitted, access denied) are recorded and stored at the PPM.
  2. If the data provider would like to check the status of data usage by application providers, the data provider access to the PPM. The data provider can recognize that which application provider accessed to what kinds of collected data.
  3. If the data provider would like to delete the collected data that were stored in the application service providers, the data provider can request the application service providers to delete the transferred data by specifying access record in the PPM.

### 12.16.7 Alternative flow

None

### 12.16.8 Post-conditions

None

### 12.16.9 High Level Illustration

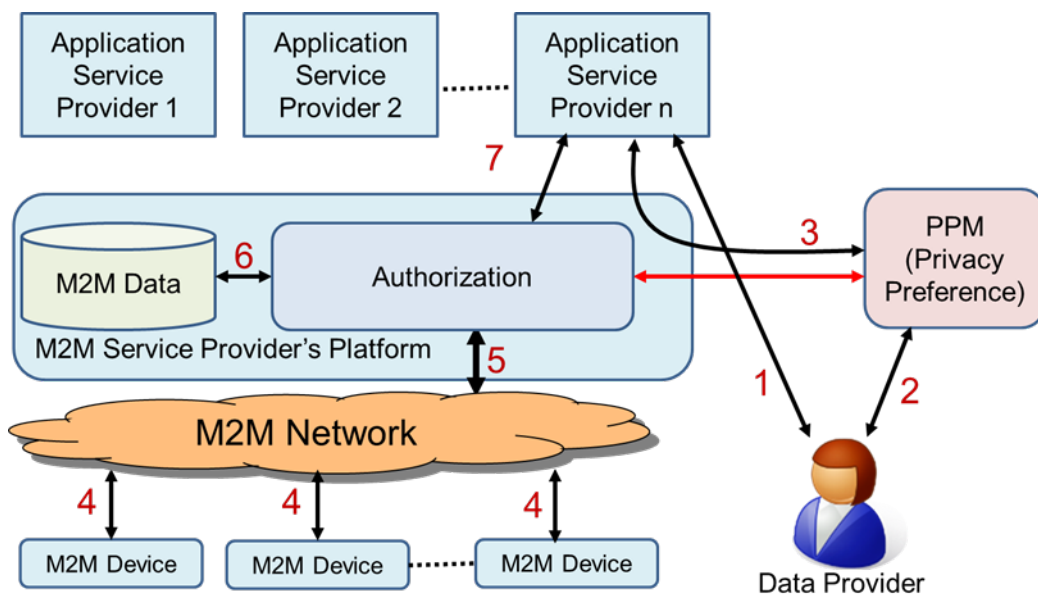


Figure 12-27 Overview of Personal Data Management mechanism using PPM

### 12.16.10 Potential requirements

1. The M2M system shall support the capability of managing the data collection and access to the collected data by using authorization mechanism to avoid unnecessary and unwanted personal information access based on the privacy preference defined by the data provider.
2. The M2M Service Provider's Platform system shall provide an interface that enables access control for personal data of a data provider by using access control policy defined by the data provider as privacy preference.

## 12.17 Quality of Sensor Data

### 12.17.1 Description

It is quite popular to transmit observation values of the sensor as a form of time series data in social infrastructure, i.e. factories, power plants, water systems, or railroad systems. In these handling of sensor values, observation value is transmitted with “quality bit”, which represents quality of data, i.e. the observation value is valid or not by reference to predefined normal operating condition of the sensor.

The quality bit is used as a quality indicator of observation value of sensor. In other words, it is used as a basis for considering whether the value is usable or not, or how the value should be used.

Here we consider an example case where water is stored in a tank and is conveyed by a pump. The water level of a tank is observed by a sensor, and data collection policy (named data catalogue) is utilized at oneM2M MN to transmit average of 2 observation values. The observation value is not adequate to be utilized when there is any abnormality in the electric power source of the sensor or in controller. The average value is not adequate to be utilized when one of observation values is not adequate. Therefore, information such as “the observation value of sensor of water level lacks quality” is added in order to make the application work as intended.

### 12.17.2 Source

REQ-2015-0599R03 Sensor Data Quality

### 12.17.3 Actors

- Tank1: Tank stores water
- Pump1: Pump conveys water
- Water level sensor1: It observes water level of a tank1 and transmit the observation value d1 to PLC/DCS1 at fixed time intervals
- Electric power source of water level sensor1: It supplies electric power which is required for the water level sensor1 to work correctly
- PLC(Programmable Logic Controller)/DCS(Distributed Control System)1: PLC/DCS receives two observation values, i.e. water level of tank1 and status signal of electric power source of water level sensor1, and transmit a form of water level data d1 with a quality bit q1 at fixed time intervals. When the electric power source of water level sensor1 is abnormal or PLC/DCS1 itself has some abnormality, the water level observation value d1 is considered to be incorrect and the quality bit q1 is set to “not good.”
- Tank2: Tank stores water
- Pump2: Pump conveys water
- Water level sensor2: It observes water level of tank2 and transmit the observation value d1 to PLC/DCS2 at fixed time intervals
- Electric power source of water level sensor2: It supplies electric power which is required for the water level sensor to work correctly
- PLC/DCS2: PLC/DCS receives two observation values, i.e. water level of tank2 and status signal of electric power source of water level sensor2, and transmit a form of water level data d2 with a quality bit q2 at fixed time intervals. When the electric power source of water level sensor2 is abnormal or PLC/DCS2 itself has some abnormality, the water level observation value d2 is considered to be incorrect and the quality bit q2 is set to “not good.”
- oneM2M MN: oneM2M MN receives water level observation values d1 and its corresponding quality bit q1 from PLC/DCS1 as a form of time series data, receives water level observation value d2 and its corresponding quality bit q2 from PLC/DCS2 as a form of time series data, calculates average value d3 as specified by data catalogue, and transmits the average value d3 and its quality bit q3 to oneM2M platform. When quality bit q1 or q2 is “not good”, the calculated average d3 is considered to be incorrect and quality bit q3 is set to “not good.”
- oneM2M platform: oneM2M platform receives time series data and its corresponding quality bit from oneM2M MN and transmit them to Application.
- oneM2M Application: oneM2M Application receives time series data and its corresponding quality bit, and performs user-defined procedure(s) referring quality bit value.
- Real-time Ethernet: Real-time Ethernet connects PLC/DCS and oneM2M MN.

- Underlying network: connects oneM2M MN and oneM2M platform.

#### 12.17.4 Pre-conditions

Observation value of sensor is coupled with its quality bit and correspondence relation is defined.

#### 12.17.5 Triggers

PLC/DCS receives observation value at fixed time intervals and receives status signal of electric power supply of the water volume sensor.

#### 12.17.6 Normal Flow

1. When the electric power source of water level sensor1 is normal and PLC/DCS1 has no abnormality, the observation value d1 is considered to present correct water level and to be usable and PLC/DCS1 adds quality bit q1 “good” to the observation value d1. Otherwise, when the electric power source of water level sensor 1 is abnormal or PLC/DCS1 has some abnormality, the observation value d1 is considered to be incorrect and PLC/DCS1 adds quality bit q1 “not good” to the observation value d1. Similarly, PLC/DCS2 adds quality bit q2 “good” or “not good” to the observation value d2.
2. oneM2M MN receives observation value d1 and its corresponding quality bit q1 from PLC/DCS1 as a form of time series data receives observation value d2 and its corresponding quality bit q2 from PLC/DCS2 as a form of time series data, calculates average value d3 as specified by data catalogue, and transmits the average value d3 and its quality bit q3 to oneM2M platform. When q1 or q2 is “not good”, the calculated average value d3 is considered to be incorrect and quality bit q3 is set to “not good.”
3. oneM2M platform receives time series data and its corresponding quality bit from oneM2M MN, and transmits them to oneM2M application.
4. Application receives time series data and its corresponding quality bit from oneM2M platform and performs user-defined procedure(s) referring quality bit value. Usually, observation value with quality bit “not good” is not used to monitoring or controlling functions.

#### 12.17.7 Alternative flow

None.

#### 12.17.8 Post-conditions

None.

#### 12.17.9 High Level Illustration

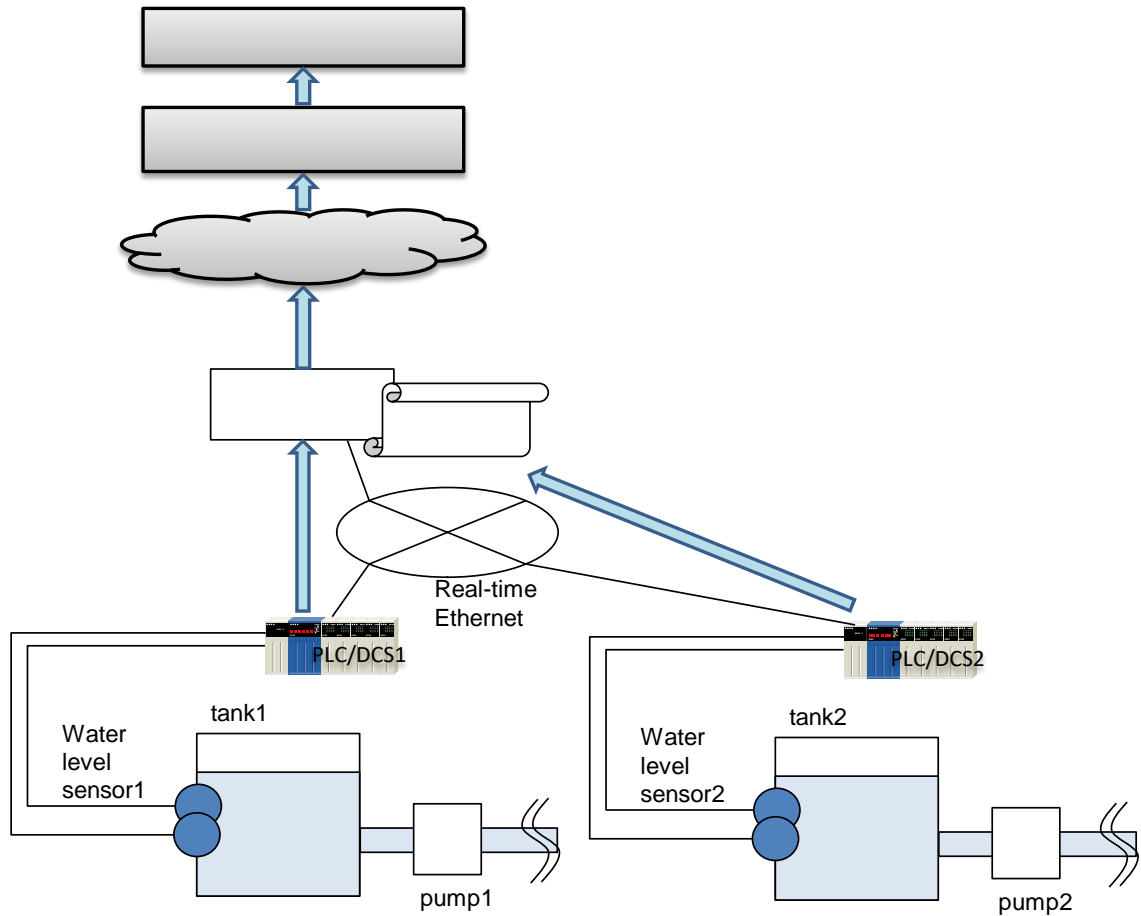


Figure 12-28 Quality of sensor data

### 12.17.10 Potential requirements

1. The oneM2M system shall provide capability to manage data quality description of resource.

## 12.18 Agriculture monitoring drone system

### 12.18.1 Description

Drone was originally developed for military purpose for surveillance of enemy troops. However, the drone is now used in a wide variety area specifically in sport, logistic, media, industry, and agriculture area. Since drone can be equipped with GPS flight assistance, Sensor, Radar, and Camera, it can detect abnormal action when it fly over the farmland and report the data to the administration centre. In addition, the drone can carry pesticides and spray over the crop to protect it from fungal infections.

Drone collects the information regarding the condition of farmland and crop and send the monitoring data to the administration centre. At agriculture administration centre, the aggregated data can be analysed and the information used for smart faming solution e.g., knowing how much fertilizer needs to be used, detecting what harmful insects are living in the farmland.

Drone is operated with battery power and after receiving command message from administration centre, it follows the action described in the command message e.g., modifying monitoring region coverage, coming back to the battery charging station. If a series of command messages are not delivered to each drone because

of communication loss or if the message is delivered well but it malfunctioned then the desired actions are not performed. In order to prevent this situation, service transaction mechanism was introduced in the M2M platform. This use case is based on service transaction and this additionally introduces policy-based transaction rescheduling mechanism.

## 12.18.2 Source

REQ-2015-0607R01 Use Case for Agricultural Drone

## 12.18.3 Actors

- Drone, which can monitor the condition of farmland and crop and report data to the administration centre through M2M platform. It also carry pesticides or fertilizer on the move to spray over the crop.
- M2M Platform, which can manage the resources about drones and receive message from drone and deliver control message to the drone connected via access network.
- Agriculture Monitoring administration Centre (AMC), which receive the data from drones for monitoring farmland and crops and send the command message to each drone for desired action.

## 12.18.4 Pre-conditions

None

## 12.18.5 Triggers

The battery level of one drone is low and needs to be recharged. In this situation, AMC sends the drone a command message which indicates the drone coming back. At the same time, AMC sends group of drones command messages which direct coverage modification about monitoring region.

## 12.18.6 Normal Flow

00. All Drone are registered with M2M Platform and AMC sends control messages to each drone for monitoring the farmland and crop.
01. If one drone's battery level become low, AMC gets this information and waits for sending the control message which indicates the drone with low level battery should come back to the battery charging station. If one drone come back to the charging station and then the number of drone monitoring the farmland decrease. Thus each drone needs to update its monitoring coverage. To this end, AMC waits for sending each drone control messages which indicate modifying its monitoring coverage.
02. Because a series of command message is important, AMC initiates transaction triggering mechanism and sends command message to drone 1~6.
03. In this situation, drone 1~5 responded with success information, drone 3 has a problem and responded with failure information.
04. Because transaction mechanism was initiated, AMC sends the roll-back message to drone 1~6 which enables each drones to cancel the received command message and return to the previous status.

## 12.18.7 Alternative Flow

The alternative flow is about the scenario represents policy-based rescheduling mechanism.

00. AMC initiates transaction triggering mechanism and sends command message to drone 1~6.
01. In this situation, drone 1~5 responded with success information, drone 3 has a problem and responded with failure information.
02. Based on the responding message from drone 1~6, M2M platform triggers transaction rescheduling mechanism referring to the transaction policy.
03. Transaction group is created for transaction rescheduling for example, drone 1~3 are grouped with A, drone 4~6 are grouped with B.
04. In this case, if drone 3 fails again as the same in previous situation, only drone 1~3 in Group A would be affected by the cancellation of the operation.

## 12.18.8 Post-conditions

None.

## 12.18.9 High Level Illustration

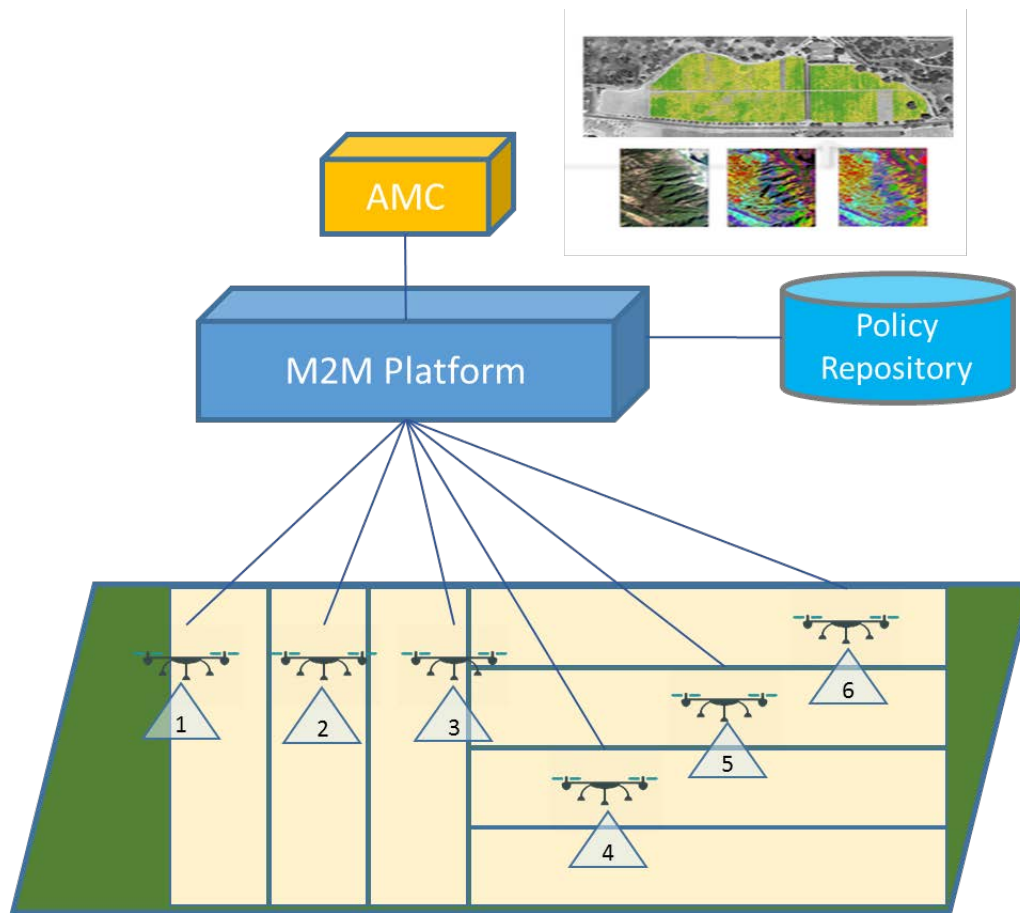


Figure 12-29 Agriculture monitoring drone system

## 12.18.10 Potential requirements

1. The oneM2M System shall support transaction management to multiple devices or applications providing policy based mechanism that should be invoked (e.g. keep status, re-schedule, rollback) depending on the outcome of the desired operation.

## 12.19 Terms And Conditions Markup Language for Privacy Policy Manager

### 12.19.1 Description

Given different legal jurisdictions and individual preferences, there is a need to at least semi-automate the process for configuring privacy preferences and agreement to Terms and Conditions (T&C's). Otherwise the user (data subject) would have to agree multiple T&C's and each smart device and service would have to have a GUI that the user would have to access and configure to set their privacy preferences by hand. A better way forward would be to allow the profile owner configure a single set of profile's (house, work, personal, parental, legal etc.) and as a new smart device or service is added:

- A. Where the terms and conditions fall within the parameters set in the user's profile, the device can be automatically authorised (with a notification to the user). If the T&C don't fall within the parameters set, only the differences (as a delta to the user's profile) are presented to the user for authorisation with the exception of the parental/Legal profile which the user will not be able to override, only the profile owner (e.g. parent/Local government respectively) can override.
- B. The user's privacy settings from their profile can be automatically configured where relevant, with confirmation notification to the user. Where it's not possible to fully configure the relevant security controls the user is alerted and can manually decide

To make this possible we need to be able to convert Terms & Conditions and privacy settings in to a standard mark-up language that can be understood by smart devices and translated in to a human readable format. Another advantage of this mark-up language will allow standard translations of this mark-up language in to multiple human languages allowing new compliant devices to be rapidly brought to market in multiple countries. Customers can also shop for devices and services that meet their requirements, such a meeting their defined minimal level of data encryption, thus allow business to more easily market the high value features of their products to mass market customers.

Consider someone buying a prebuilt new home in the year 2025, the buyer will be looking at a home with integrated smart sensors, smart home appliances, each selected by builder or their subcontractor. Each of these will potentially have a separate set of terms and conditions, such as the Oven, fridge, washing machine, security motion sensor, fire alarm etc. just in an integrated kitchen alone. Currently as part of the legal information that the builder has to provide to a buyer certain paperwork, mainly focuses on legal liabilities governed by law which the buyer's solicitor will check on buyer behalf for any issues.

In 2025 the buyer will also have to go through potentially dozens of sets of T&C before purchasing the property, the buyer may also need to check this with their insurer (e.g. who can access alarm data) and Mortgage company as they could affect the value of the property (such as the issues with zero priced solar panels & roof leases in the UK, example of devices). In addition to the smart devices, which may be tied to specific service, selected by the builder such as electrical power and water, the builder may have selected other services such as Fire and security monitoring services that are pre-configured as part of the smart home. [The builder may have selected these as they provide free trials they can use to demonstrate the features, may be required to by law (Energy), their own backers (such as banks funding the development wanting fire/security monitoring to protect their investment), the smart device makers may offer a discounted price in return for connecting the service or the builder may be provided with financial incentives to "install" a service by a specific company. There will be business interest by service providers in getting builders to pre-select and configure their services on the grounds that inertia selling will convert a percentage of home buyers in to customers.]

The home purchaser will have to read though all the terms and conditions\*, decide which he agrees with, which he does not, then go through the process to disable each of the devices/services they don't accept the T&C for, add their own selected services before configuring the devices and services how they want. In theory as each of the devices and services is gathering data about the new owner, they should suspend their operation until the user has formally provided informed consent to the T&C in accordance to local laws.

This will require that smart devices and services do the following:

- Announce their presence to the new owner.
- Be able to display their terms and conditions directly to the user.
- Have some way for the new owner to accept the terms and conditions.
- Configure their preferences
- Be able to receive a revocation of permissions command and delete user configuration to trigger the above steps.

Another option would be for all machine to machine devices to be able to communicate this information to a user's selected control devices e.g. a Smart Phone.

## 12.19.2 Source

REQ-2015-0619R02 Terms And Conditions Markup Language for Privacy Policy Manager

## 12.19.3 Actors

Names are based on the current European Union (EU) data protection definitions.

- Data subject. The living individual about who the data is captured. May or may not be the data owner.
- Data owner. The individual who owns the data. E.g. the home owner. Can be the data processor or a separate entity. [But also need to account for Non EU companies who may believe they own the data].
- Data processor. The entity who processes the data on behalf of the data owner

## 12.19.4 Pre-conditions

Not applicable

## 12.19.5 Triggers

Not applicable



## 12.19.6 Normal Flow

1. The profile owner configures a single set of profile's (house, work, personal, parental, legal etc.)
2. A new smart device or service is added:
3. Where the terms and conditions fall within the parameters set in the data subject's profile, the device can be automatically authorised (with a notification to the data subject).
4. If the T&C don't fall within the parameters set, only the differences (as a delta to the data subjects profile are presented to the data subjects for authorisation.
5. The data subject will not be able to override the parental/legal profile. Only the profile owner (e.g. parent/local government respectively) can override.
6. The data subject's privacy settings from their profile can be automatically configured where relevant, with confirmation notification to the data subject..

## 12.19.7 Alternative flow

Where it's not possible to fully configure the relevant security controls the data subject is alerted and can manually decide

## 12.19.8 Post-conditions

The data subject has given or refused informed consent for data capture for each oneM2M service based only on the deltas between each new service and the terms and conditions already accepted.

## 12.19.9 High Level Illustration

The concept of a Privacy Policy Manager (PPM), as described in TR-0016 [i.19] is

*"The PPM had been adapted to large scale HEMS (Home Energy Management System) as trial, and they had started evaluation of PPM effectiveness.*

*The PPM is based on the following two main concepts:*

- *Based on 'Privacy by Design', Inclusion in the architecture of a personal data distribution base.*
- *Based on 'Privacy First', the provision of an "end users function" by which end users can manage their own personal data distribution according to their privacy preferences."*

An overview of the proposal is shown below (Data Provider is the equivalent of Data Subject in UE data protection legislation).

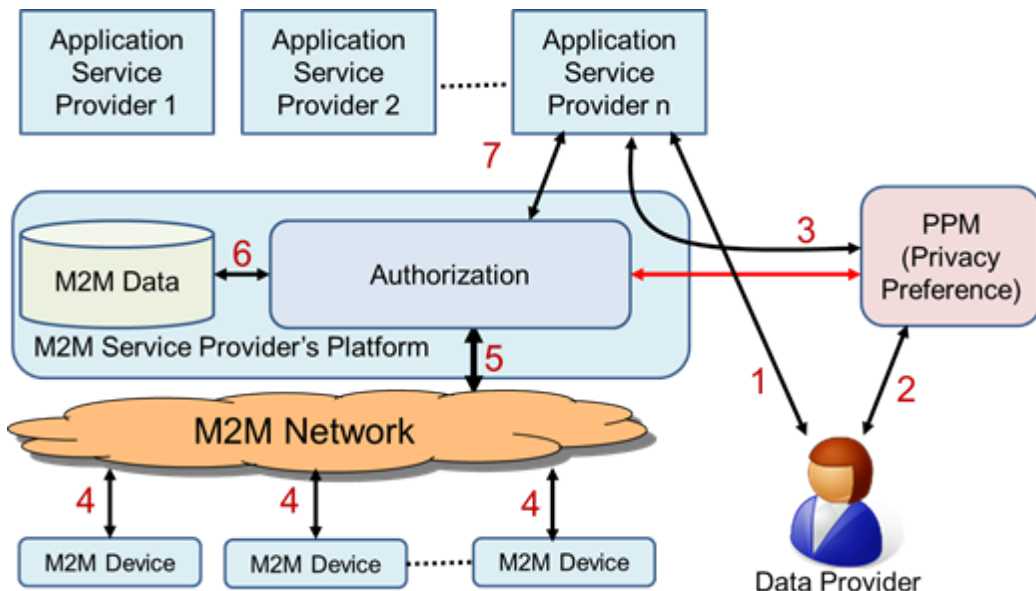


Figure 12-30 Terms And Conditions Markup Language for Privacy Policy Manager

## 12.19.10 Potential requirements

1. The oneM2M system shall store and process privacy preferences in an interoperable manner.
2. The oneM2M system shall support privacy profiles at various levels to care for conditions of legal requirements, manufacturers, and data subjects.
3. The oneM2M system shall be able to prioritise privacy profiles where there is a conflict between profiles (legal profile takes priority over data subject profile, for example).

## 12.20 Intelligent agricultural product traceability

### 12.20.1 Description

Traceability is the ability to trace backward the history (e.g. operation, location) of an entity by means of recorded identifications. It is widely used in product life-cycle monitoring. Intelligence agriculture product traceability is a typical application.

Agricultural product traceability implements a mechanism to monitor and trace the supply chain, including all the participant parties, for example, the producer, processor, logistics providers, distributors, retailers and so on. Every party has a responsibility to manage traceability information by keeping disciplined record, so that the traceability application can obtain the life-cycle information accordingly.

The **traceability information** consists of static information (e.g. product name, date of production, process information of production) and dynamic information (e.g. logistics information, and distribution information). Most information is captured by the devices. For instance, during the production phase of agricultural products the traceability information is augmented with a planting monitoring log. The planting monitoring log is composed of temperature data and humidity data, which are collected by related sensors.

Another example is the traceability information gathered during processing phases, e.g. the chemical content and dosage monitored and recorded by sensors.

For traceability requirements, the traceability information should be associated with the product identifier which usually is a unique ID stored in two-dimension code or RFID tag.

**Traceability linking** provides a mapping that relates a product identifier to product related information such as

- Logs
- Information on ID service nodes, such as:
  - servers that provide access to traceability information, and
  - devices (sensors and gateways) that gather traceability information

The **M2M service platform** is an entity that is responsible to provide the traceability linking service.

The **traceability application** can request the M2M service platform to provide traceability linking service, and then obtain corresponding traceability information.

### 12.20.2 Source

REQ-2016-0043R05 Use Case Intelligence agricultural product traceability

### 12.20.3 Actors

- Traceability application

Traceability application is the trace request initiator, which can capture traceability identifier (which is equal to, or can be transformed to product identifier) via typing or scanning. It initiates a trace request, and receives the traceability information. The traceability application is usually used by consumers or regulators.

- M2M service platform

The M2M service platform is an entity that can maintain the traceability links for product identifier and product related information. The M2M service platform can respond to queries regarding traceability links related to a product identifier.

- ID service node

The ID service nodes are

- information servers that provide access to traceability information, and
- devices (sensors and gateways) that gather traceability information

It can provide traceability linking services for product identifier and its corresponding information, forward the links to M2M service platform.

## 12.20.4 Pre-conditions

All ID service nodes register in the M2M service platform, and forward the existing traceability links for product identifier and traceability information.

## 12.20.5 Triggers

The traceability application captures a product identifier (traceability identifier), and initiates a trace request.

## 12.20.6 Normal Flow

1. The traceability application initiates a trace request.
2. The M2M service platform fetches all the traceability information related to the traceability identifier.
3. The M2M service platform provides the traceability information to the traceability application.
4. The traceability application requests the traceability information from ID service nodes.

## 12.20.7 Alternative flow

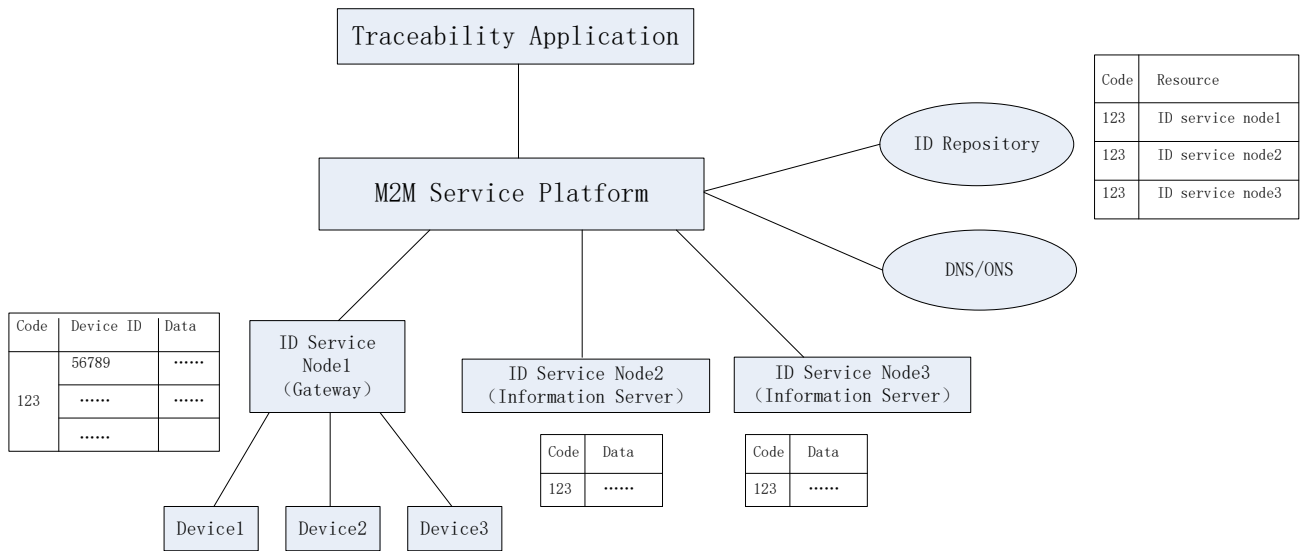
The traceability application can obtain the device identifier from M2M service platform, and access the device directly without ID service nodes.

In case the M2M service platform cannot provide accurate traceability information, it would forward the query to the ID service nodes and update the traceability link records.

## 12.20.8 Post-conditions

None.

## 12.20.9 High Level Illustration



**Figure 12-31 Intelligent agricultural product traceability**

### 12.20.10 Potential requirements

1. The oneM2M system shall be able to support the traceability linking service which provides a mapping that relates a product identifier to product related traceability information.

Traceability information consists of:

- Logs
  - Information on ID service nodes, such as:
    - i. servers that provide access to traceability information, and
    - ii. devices (sensors and gateways) that gather traceability information
2. The oneM2M system shall be able to enable applications to retrieve the traceability information related to product identifiers.

## 13 History

Publication history		
V3.1.1	2019-05-13	Release 3 - Publication

<b>Draft history</b> (to be removed on publication)		
V 3.0.1	<2017-07-09>	Merged REQ-2017-0047-TR-0001_editorials
V 3.1.0	<2017-11-30>	Merged REQ-2017-0073R02 Editorials corresponding to ITU-T transposition updates