

TTC STANDARDS

JJ-50.10

Digital Transmission System for Metallic Local Lines in the Public Data Networks

(English Edition)

Version 3

April 23, 1997

THE TELECOMMUNICATION TECHNOLOGY COMMITTEE



Introduction

This document is an English translated document of JJ-50.10 version 3 Japanese Edition. JJ-50.10 provides the TTC original Standard formulated and put into effect by the Technical Assembly. It contains unabbreviated version of 'JJ-' Standard, which has not been defined as international standard.

In case of dispute, the original to be referred is the Japanese edition of the text.

We trust that greater understanding of TTC Standards by a wider range of users will further contribute to the development of telecommunications.

April 23, 1997

J J - 5 0 . 1 0 D i g i t a l T r a n s m i s s i o n S y s t e m f o r M e t a l l i c L o c a l L i n e s i n t h e P u b l i c D a t a N e t w o r k s

<References >

1 . R e l a t i o n t o i n t e r n a t i o n a l r e c o m m e n d a t i o n s

This standard prescribes a digital transmission system (Note) for public data transmission services, namely circuit switched, packet switched and leased circuits, in the public data communication networks specified in ITU-T X series recommendations(1988). This standard covers the characteristics and parameters of a 4-wire local line system at the network side of Data Terminal Equipment (DTE) for the public data networks.

The interfaces between DTE and Data Circuit terminating Equipment (DCE) are specified in ITU-T Rec. X.20, X.20bis and X.21bis. Specifications for loop testing are based on ITU-T Rec. X.150.

Note: Modem-transmission systems are not included in the scope of this standard.

2 . I t e m s f o r f u r t h e r s t u d y

(a) 4.2.5: Electrical Environment

As for item (a), this issue is included in the standardization because specifications for lightning surges to the various groundings are inevitable from the viewpoint of safety. The issue, however, is one for further study by the ITU-T SG 5 and relevant national committees.

3 . H i s t o r y o f r e v i s i o n

Version	History of revision dates	Remaks
version 1	1990.11.28	Established
version 2	1993.11.26	Revision of artificial line loss characteristics (Table4-2) Revision of Disturbance wave regulation.(Appendix 2)
version 3	1997.4.23	Delection of Electric Magnetic Interference(EMI) Regulation since EMI Regulation is to be Separately prescribed.

4 . O t h e r s

(1) Referred recommendations and regulations

TTC standards: JT-I430

ITU-T recommendations: X.20, X.20bis(1988)

X.21, X.21bis(1988)

X.150(1988)

Contents

1 . O u t l i n e	1
1.1 Scope of prescription.....	1
1.2 Vocabulary	2
2 . F u n c t i o n a l o v e r v i e w.....	2
2.1 Functional outline	2
2.2 Data signal rate and corresponding bearer rate	3
3 . L o g i c a l I n t e r f a c e S p e c i f i c a t i o n s	4
3.1 Definition of Signals.....	4
3.2 Frame Configuration.....	4
3.3 Frame Synchronization.....	4
3.4 The signal in the local transmission system corresponding to the DTE side interface.....	5
3.4.1 For the case in which the DTE side interface is based on ITU-T Rec. X.20, X.21.....	5
3.4.2 The DTE side interface is based on ITU-T Rec. X.20bis, X.20bis	7
4 . E l e c t r i c a l i n t e r f a c e a n d p h y s i c a l i n t e r f a c e	8
4.1 Physical characteristics.....	8
4.2 Electrical characteristics.....	9
4.2.1 Transmission Code.....	9
4.2.2 Clock	9
4.2.3 Output Signal Conditions	10
4.2.4 Receiver Conditions.....	12
4.2.5 Electrical Environmental Conditions.....	13
4.2.6 Interconnecting Media Characteristics.....	15
5 . M a i n t e n a n c e	19
5.1 Loop Back Testing	19
5.2 Indication of trouble conditions	20
Appendix 1: Definitions of signals in the interface between DTE and DCE (for TTC standard JJ-50.10)	21
Appendix 2: The definition of the loops for ITU-T Rec. X.150 (based on TTC standard JJ-50.10)	24

1 . O u t l i n e

1.1 Scope of prescription

This standard prescribes digital transmission systems for public data transmission services, namely circuit switched, packet switched and leased circuits, in the public data communication networks specified in ITU-T X series recommendations. This standard covers the characteristics and parameters of a 4-wire local line system at the network side of Data Terminal Equipment (DTE) for the network public data networks.

The reference configuration for digital transmission systems in this standard is shown in Figure 1-1/JJ-50.10. In this figure, the term "DTE" and "DCE" are used to indicate functional groups corresponding to Data Terminal Equipment and Data Circuit Terminating Equipment, respectively, which are specified in ITU-T X series Recommendations. The term "LT" is used to indicate line terminating functions for a digital transmission system.

A access digital section is also shown in Figure 1-1/JJ-50.10. The definition of access digital section is for specifying functions and procedures.

The interfaces between DTE and DCE are specified in ITU-T Rec. X.20bis, X.21 and X.21bis.

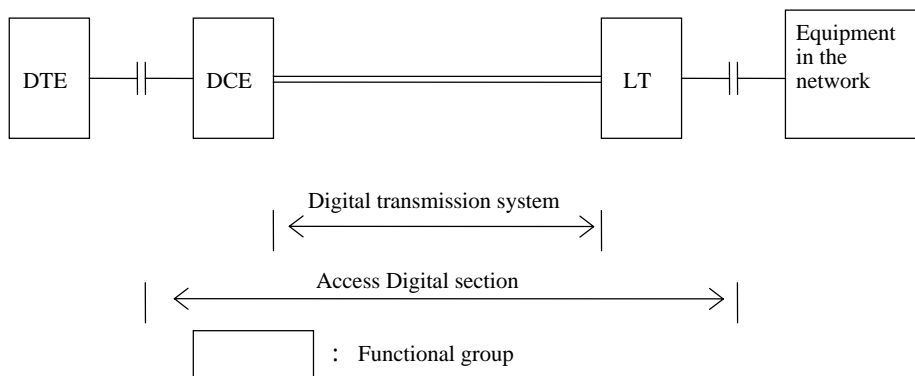

Figure 1-1/JJ-50.10 Reference configuration for digital transmission system

1.2 Vocabulary

Term	Description
(1) Digital Transmission system	The specification states which system supplies the digital transmission section
(2) Digital Terminal Equipment (DTE)	Function or equipment which sends or receives data
(3) Data Circuit-terminating Equipment (DCE)	Function or equipment which converts signals or codes between the DTE and the digital transmission system
(4) Line Termination (LT)	Function or equipment which terminates the digital transmission system
(5) Bridge Tap (BT)	Branch line which is open at the point
(6) Bearer Rate	Transmission bit-rate of the digital transmission system
(7) Envelope Signal	Transmission form of data of the digital transmission system. "One envelope" is made up of (n+2) bits of F-D-S. F : Frame bit (1 bit) D : Data bit (n bit) S : Status bit (1 bit)
(8) Alternate Mark Inversion Code (AMI)	Code which sends output alternately positive 1(+1) or negative 1(-1) each time a 1 is generated (AMI) as input information

2 . F u n c t i o n a l o v e r v i e w

2.1 Functional outline

Figure 2-1/JJ-50.10 shows the functions required in the digital transmission system.

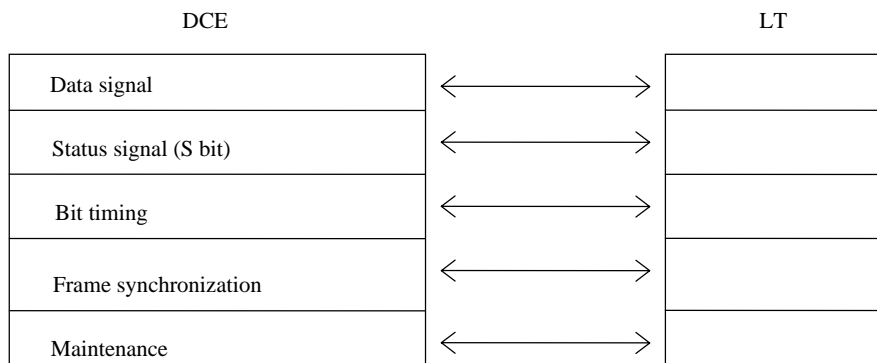

Figure 2-1/JJ-50.10 Functional overview

(1) Data signal

This function gives 1200bit/s or less asynchronous data services and 2400bit/s, 4800bit/s, 9600bit/s and 48kbit/s synchronous data services.

The rate of the data signal is defined as the data bit rate and rate of the digital transmission system as a bearer rate.

(2) Status bit (S bit)

This function gives the information that identifies line status.

(3) Bit timing

It gives the information to restore time division multiplex channels.

(4) Frame synchronization

It gives DTE or LT the function that restores time division multiplex channels.

(5) Maintenance

It gives the function that transmits a code to notify the terminal (DTE) that a failure exists between the DCEs (DNR) and a code to indicate that a failure exists on the DTE side, or is in an inoperable condition (UNR) within the access digital section. (See 5.2)

2.2 Data signal rate and corresponding bearer rate

The signaling conversion function for DCE, which transmits data signals at the DTE ~ DCE interface within the digital section, is explained below.

- (1) Data signals sent from the DTE side are encoded to produce D bits, either by multi-sampling if the data signaling rate is 1200bit/s or less (asynchronous operation), or by single point sampling with the same rate as the data signaling rate if the rate is 2400bit/s or more (synchronous operation).
- (2) The status bit(S bit) and frame bit(F bit) are added to the above data bits(D bits), which are converted to a (6+2) envelope signal (at the bearer rate),and are sent to the line S side. Input signals from the line R side are decomposed to F bit, S bit, and D bits by envelope synchronization. The D bits are sent to the DTE side after converting and decoding.

Table 2-1/JJ-50.10 shows the data signal rate and corresponding bearer rate.

Table 2-1/JJ-50.10 data signal rate and corresponding bearer rate

	data bit rate	bearer rate
asynchronous	300bit/s or less	3.2kbit/s
	1200bit/s or less	12.8kbit/s (6.4kbit/s)(Note)
synchronous	2400bit/s	3.2kbit/s
	4800bit/s	6.4kbit/s
	9600bit/s	12.8kbit/s
	48kbit/s	64kbit/s

Note : 12.8kbit/s for circuit switched service,

6.4kbit/s for leased circuit service or packet switched service

3 . L o g i c a l I n t e r f a c e S p e c i f i c a t i o n s

3.1 Definition of Signals

The signals appearing on digital transmission systems are defined in Table 3-1/JJ-50.10.

Table 3-1/JJ-50.10 Definition of Signals

Binary Base	(Note) Digital transmission section
0	No bipolar pulse
1	Bipolar pulse

Note: definitions of bipolar pulses are described in section 4.2.3

3.2 Frame Configuration

The basic frame configuration employs a signaling format in an F-D-S arrangement: 6 data bits (D bit), a status bit (S bit) for indication of line status, and a frame bit (F bit) for transmission of frame clock.

The configuration is called a "(6+2)" envelope configuration. Figure 3-1/JJ-50.10 shows the configuration.



F: Frame bit (alternately 1 or 0)

D1 ~ D6: Data signal

S: Status bit

Figure 3-1/JJ-50.10 (6+2) Envelope Configuration

3.3 Frame Synchronization

The status of a DCE hunting (searching) a frame pattern is called an "out of frame state" of the envelope synchronization circuit, and the status of a DCE establishing a frame synchronization is called an "in frame state". The "forward protecting state" means the DCE detects a false pattern in the alternate 1, 0 sequence of the frame bit in the "in frame state". A reframe procedure must be started when an error in frame bit is detected continuously in the "forward protecting state of the envelope synchronization circuit". Frame synchronization is done by way of continuous bit shift. Detection of the synchronous pattern is judged by the F bit position that is determined by the exclusive OR of the bit received one frame previously and the currently received bit.

Under the "out of frame state", the DCE must transmit the [F 0 0 0 0 0 0 0] pattern to the local transmission system.

3.4 The signal in the local transmission system corresponding to the DTE side interface

3.4.1 For the case in which the DTE side interface is based on ITU-T Rec. X.20, X.21.

The signal relationships of the "DTE to DCE" direction and the "DCE to DTE" direction are shown in Table 3-2/JJ-50.10 and Table 3-3/JJ-50.10, respectively. Detailed specifications of the DTE-DCE interface are based on ITU-T Rec. X.20 and X.21. An outline of the interface signals is shown in Appendix 1.

Table 3-2/JJ-50.10 DTE DCE Direction

	Type of Use	(Note 1) DTE Side Interface	Local Transmission System	Conditions
	Asynchronous / synchronous			
Circuit Switched Service	Asynchronous lower than 300bit/s lower than 1200bit/s	T=D =(D1D2D3D4D5D6)	FD1D2D3D4D5D6 1	T (0,0,0,0,0,0)
		T=0 =(000000)	F0000001	Within t (Note2) after T (0,0,0,0,0,0)
			F0000000	At or past t (Note2) after T (0,0,0,0,0,0).
	Synchronous 2400bit/s 4800bit/s 9600bit/s 48kbit/s	T=D =(D1D2D3D4D5D6) C=ON	FD1D2D3D4D5D6 1	
		T=D =(D1D2D3D4D5D6) C=OFF	FD1D2D3D4D5D6 0	
Packet Switched Service and Leased Line Service	Asynchronous lower than 300bit/s lower than 1200bit/s	T=D =(D1D2D3D4D5D6)	<u>FD1D2D3D4D5D6</u> 1	T (0,0,0,0,0,0)
		T=0 =(000000)	F1111111	Within t (Note2) after T (0,0,0,0,0,0).
			F1111110	At or past t (Note 2) after T (0,0,0,0,0,0).
	Synchronous 2400bit/s 4800bit/s 9600bit/s 48kbit/s	T=D =(D1D2D3D4D5D6) C=ON	FD1D2D3D4D5D6 1	
		T=D =(D1D2D3D4D5D6) C=OFF	F1111110	T (0,0,0,0,0,0)
		T=D =(D1D2D3D4D5D6) C=OFF	F0010100	When transmitting UNR. (See 5.2)

Note 1: Signals T and C are based on specifications of the ITU-T Rec. X.20 and X.21, C and T=(D1 D2 D3 D4 D5 D6) indicate coded values of "Control" and "Transmit", respectively; i.e., each constitutes the 6 data bits included in the (6+2) envelope.

$\overline{D_i}$ indicates a logical negation of D_i

Note 2: t=10 to 390 msec.

Table 3-3/JJ-50.10 DTE DCE Direction

	Type of Use	(Note 1) DTE Side Interface	Local Transmission System	Conditions
	Asynchronous / Synchronous			
Circuit Switched Service	Asynchronous lower than 300bit/s lower than 1200bit/s	R=(D1D2D3D4D5D6)	FD1D2D3D4D5D6 S	
	Synchronous 2400bit/s 4800bit/s 9600bit/s 48kbit/s	R=(D1D2D3D4D5D6) I=ON	FD1D2D3D4D5D6 1	Normal condition
		R=(D1D2D3D4D5D6) I=OFF	FD1D2D3D4D5D6 0	
		R=(D1D2D3D4D5D6) I maintains the status at 3 envelopes before "forward protection condtion"	FD1D2D3D4D5D6 S	In case of "forward protection condition"
Packet Switched Service and Leased Line Service	Asynchronous lower than 300bit/s	<u>R=(D1D2D3D4D5D6)</u>	FD1D2D3D4D5D6 S	On line conditions (Note 2)
	lower than 1200bit/s	R=(0 0 0 0 0 0)		Off line conditions (Note 3)
	Synchronous 2400bit/s 4800bit/s 9600bit/s 48kbit/s	R=(D1D2D3D4D5D6) I=ON	FD1D2D3D4D5D6 1	Normal condition
		R=(D1D2D3D4D5D6) I=OFF	FD1D2D3D4D5D6 0	Normal condition AND (i.e.logical product) (D1D2D3D4D5D6) (001010)
		R=(000000) I=OFF	F0010100	When receiving UNR(see 5.2)
		R=(D1D2D3D4D5D6) I maintains the status at 3 envelopes before "forward protection condition"	FD1D2D3D4D5D6 S	In case of "forward protection condition.

Note 1: Signals R and I are based on specifications of the ITU-T X.20 and X.21,

I and R = (D1 D2 D3 D4 D5 D6) are signals of "Indicate" and "Receive", respectively, which are the decoded data bits included in the (6+2) envelope.

$\overline{D_i}$ indicates a logical negation, of D_i .

Note 2: Conditions received after 3 consecutive S=1, and "forward protection condition" followed by "on line conditions".

Note 3: Conditions received after 3 consecutive S=0, and "forward protection condition" followed by "off line conditions".

3.4.2 The DTE side interface is based on ITU-T Rec. X.20bis, X.20bis.

The signal relationships of "DTE to DCE" direction and "DCE to DTE" direction in switched service (circuit switched, packet switched) and leased line service are shown in Table 3-4/JJ-50.10 and Table 3-5/JJ-50.10, respectively. Detailed specifications of the DTE-DCE interface are based on ITU-T Rec. X.20bis and X.21bis. An outline of the interface signals is shown in Appendix 1.

Table 3-4/JJ-50.10 DTE DCE Direction

Bit Rate	(Note 1) DTE Side Interface	Local Transmission System	Conditions
Asynchronous	SD=(D1 D2 D3 D4 D5 D6)	$\overline{FD1D2D3D4D5D6} 1$	RS=ON AND DR=ON
lower than 300bit/s lower than 1200bit/s		F1111110	RS=OFF OR DR=OFF
Synchronous	SD=(D1 D2 D3 D4 D5 D6)	$\overline{FD1D2D3D4D5D6} 1$	RS=ON AND DR=ON
2400bit/s 4800bit/s 9600bit/s 48kbit/s		F1111110	RS=OFF OR DR=OFF

Note 1: SD=(D1 D2 D3 D4 D5 D6) indicates coded value of SD; i.e., consists of the 6 data bits included in the (6+2) envelope.

$\overline{D_i}$ indicates a logical negation of D_i

Table 3-5/JJ-50.10 DTE DCE Direction

Bit Rate	(Note 1) DTE Side Interface	Local Transmission System	Conditions
Asynchronous	$\overline{RD=(D1 D2 D3 D4 D5 D6)}$	FD1 D2 D3 D4 D5 D6 S	CD=ON
lower than 300bit/s lower than 1200bit/s	RD=(1,1,1,1,1,1)		CD=OFF
Synchronous	$\overline{RD=(D1 D2 D3 D4 D5 D6)}$	FD1 D2 D3 D4 D5 D6 S	CD=ON
2400bit/s 4800bit/s 9600bit/s 48kbit/s	RD=(1,1,1,1,1,1)		CD=OFF

Note 1: RD=(D1 D2 D3 D4 D5 D6) is signal of RD, which is the decoded bits included in the (6+2) envelope.

$\overline{D_i}$ indicates a logical negation of D_i .

4 . E l e c t r i c a l i n t e r f a c e a n d p h y s i c a l i n t e r f a c e

4.1 Physical characteristics

A DCE and an LT are connected to the subscriber line in pairs.

The subscriber line is made of symmetrical pairs.

The connection form of a DCE and digital transmission system is shown in Figure 4-1/JJ-50.10.

Electrical characteristic requirements of JJ-50.10 apply to the interface points Ia and Ib.

The Ia interface point of a DCE is not permanently connected to the subscriber line (for example, fixed with a screw).

The connector to be used requires further study.

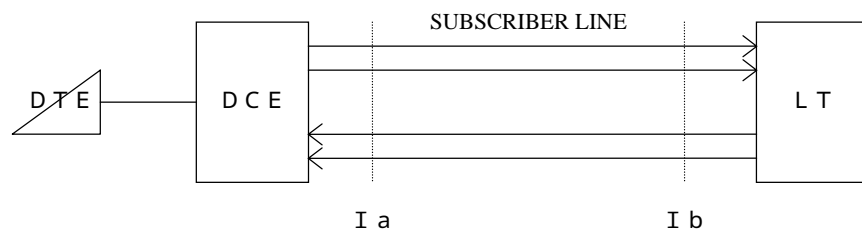

Note: Ia interface point is a DCE input/output port.

Ib interface point is an LT input/output port.

Where the connecting wires are connected internally to the DCE, the connecting cord may be considered as an integral part of the interface wiring

Figure 4-1/JJ-50.10.

Connection form of DCE and digital transmission system

4.2 Electrical characteristics

Table 4-1/JJ-50.10 shows an outline of the electrical characteristics.

Table 4-1/JJ-50.10 Outline of the Electrical Characteristics.

Line Bit Rate \ Item	3.2kbit/s	6.4kbit/s	12.8kbit/s	64kbit/s
Line Code	AMI (Note 1)			
Receiver Input Impedance	Nominal 110 ohms (Note 2)			
Balanced / Unbalanced	Balanced circuit			

Note 1: AMI Code, see 「 § 1.2 Vocabulary 」 .

Note 2: The return loss of the impedance shall be greater than 15dB.

(see § 4.2.4)

4.2.1 Transmission Code

AMI code shall be used.

4.2.2 Clock

4.2.2.1 Timing extraction

For the DCE drivers, its timing is synchronized to the network clock.

The DCE should extract the network clock signal from the received signal.

In an unsynchronized condition (e.g. DCE internal clock is set to the free run mode), the frequency deviation of the free-running clock shall not exceed ± 100 ppm for the nominal bit rate.

4.2.2.2 DCE jitter characteristics

Timing extraction jitter, as observed at the DCE output, should maintain the following specification when the jitter is measured under the test conditions described in Figure 4-2/JJ-50.10.

DCE output jitter, 0.2UI (p-p):

1UI=1/bearer rate

This limitation applies for all data sequences, but for the purpose of demonstrating the compliance of the equipment, it is sufficient to measure jitter with the additional input signal conditions specified in (a) to (c) below.

(a) A sequence consisting of continuous frames with all binary "0s" in the D-and S-channels as described in

Figure 3-1/JJ-50.10

- (b) A sequence consisting of continuous frames with the "001010" in D-channels and binary "0s" in S-channels as described in Figure 3-1/JJ-50.10
- (c) A sequence consisting of a pseudo random pattern with a length of $2^9 - 1$ in D-channels and binary "1s" in S-channels as described in Figure 3-1/JJ-50.10

The wander description is for further study.

(1) Measurement system

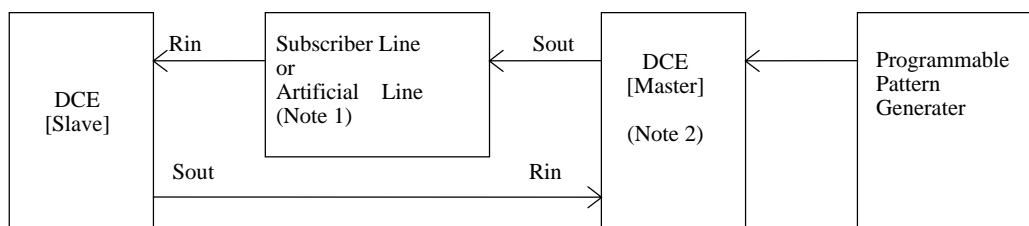

Figure 4-2/JJ-50.10 DCE Output Jitter Measurement System

(2) Measurement procedures

1. The Sout signal of the DCE [Slave] shall be measured using the Sout signal of the DCE [Master] as the trigger. Measurement is recommended using the 『CONTINUOUS』 mode (over write mode of displayed signal). In the case when measurement is difficult, each send clock may be used instead of each Sout signal. The measurement time shall be approximately one minute.
2. Line loss of the subscriber line or artificial line, is to be set at both 0dB and 40dB after setup.

Note 1: The measurement shall be done with an actual subscriber line.

But, if the actual subscriber line is not available, an artificial line may be used.

Line is used for the 3.2kbit/s bearer rate. Line for 6.4kbit/s, Line for 12.8kbit/s, and Line for 64kbit/s.

Note 2: DCE [Master] shall be set to free-running clock mode.

4.2.3 Output Signal Conditions

The pulse shape of the transmitter output shall be within the mask of Figure 4-3/JJ-50.10 when the transmitter is terminated with a 110 ohm resistor.

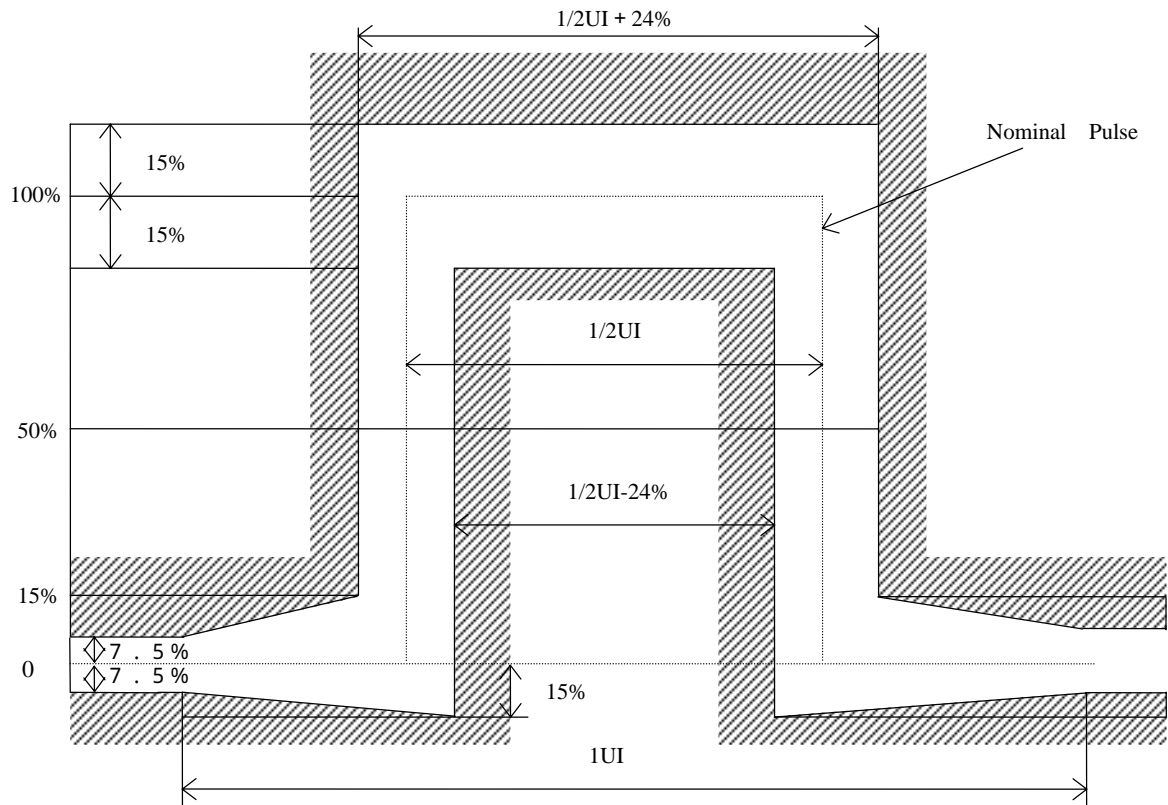

Note: $1UI=1/\text{Bearer Rate}$. The nominal pulse amplitude and the nominal pulse width at 1/2 of its amplitude for each bearer rate are shown below.

Nominal Pulse Amplitude and Nominal Pulse Width (1 / 2UI)

Bearer Rate	3.2kbit/s	6.4kbit/s	12.8kbit/s	64kbit/s
Nominal Pulse Amplitude	3.0 V	3.0 V	3.0 V	3.0 V
Nominal Pulse Width (1/2UI)	156 μ s	78 μ s	39 μ s	7.8 μ s

Figure 4-3/JJ-50.10 Output Pulse Mask

4.2.4 Receiver Conditions

4.2.4.1 Return loss

The return loss in the frequency range of 100Hz to $f_o/2$ (f_o :bearer rate) shall be more than 15dB when the receiver input is terminated in a 110 ohm resistor. The measurement setup is shown in Figure 4-4/JJ-50.10.

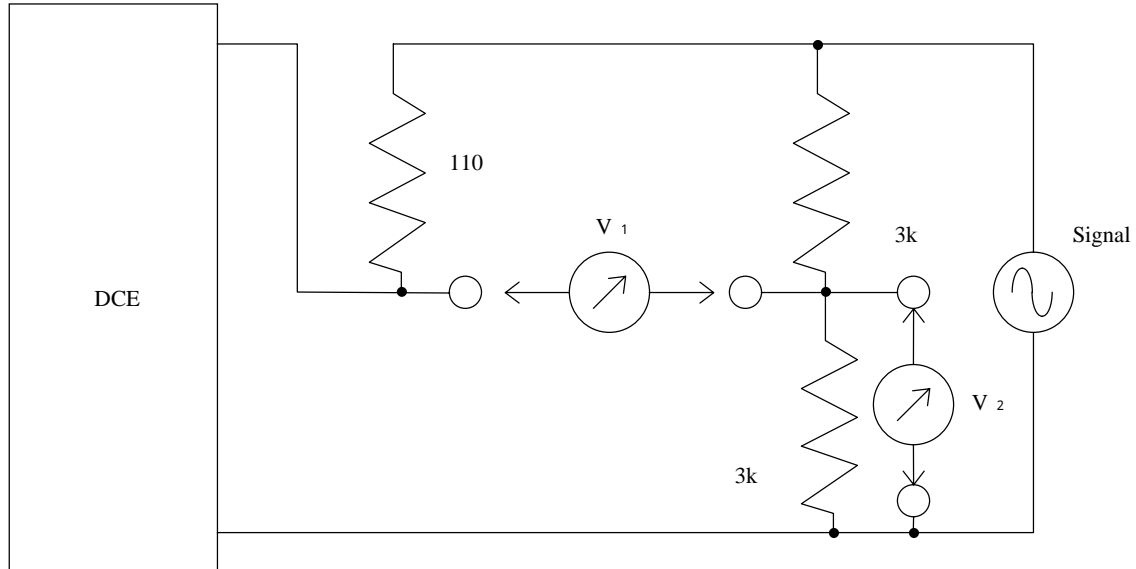

The value of resistors must be within 0.1% of the nominal value.

$$\text{Return loss} = 20 \log \left| \frac{V_2}{V_1} \right| \text{ (dB)}$$

Figure 4-4/JJ-50.10 Return Loss Measurement Setup

4.2.4.2 Unbalance about earth

The longitudinal conversion loss for a receiver input in the frequency range of $f_o/100$ to $f_o/2$ (f_o :bearer rate) shall be more than 60dB. The measurement setup is shown in Figure 4-5/JJ-50.10.

4.2.4.3 DC characteristics

A maximum direct current of 15mA from the network may be applied between the transmitter output pair and the receiver input pair of the DCE in order to control the test loop.

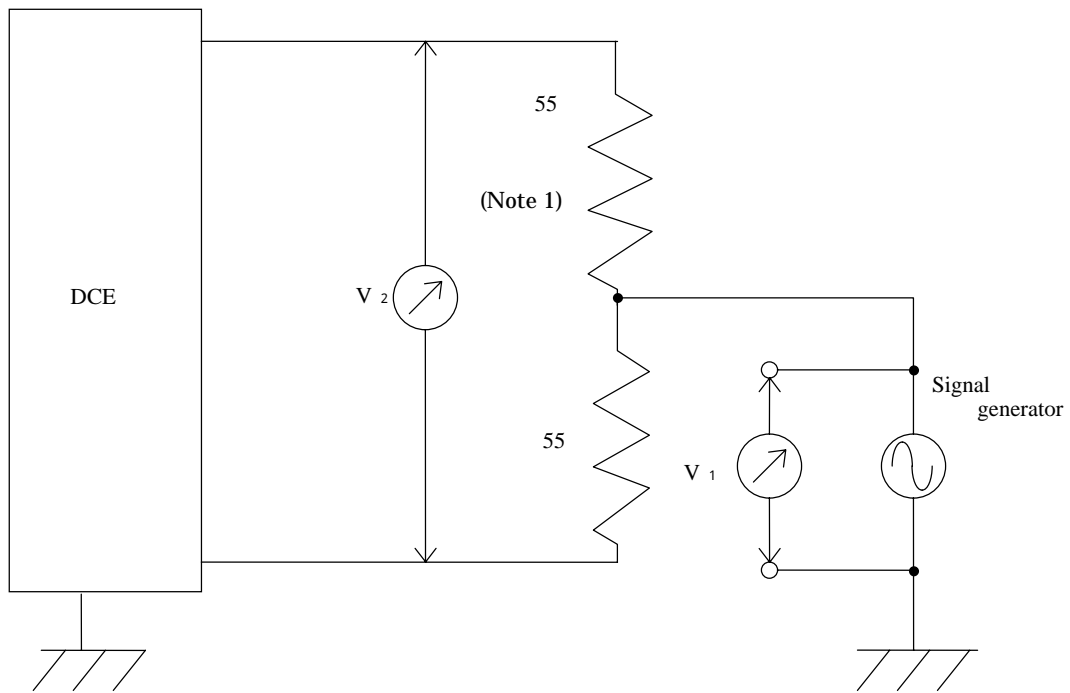

Note 1: Use well balanced measuring equipment.

Note 2: The value of resistors must be within 0.1% of the nominal value.

$$\text{Longitudinal conversion loss} = 20 \log \left| \frac{V_1}{V_2} \right| \text{ (dB)}$$

Figure 4-5/JJ-50.10 Longitudinal Conversion Loss Measurement Setup

4.2.4.4 Line Loss

Under the conditions shown in section 4.2.7, line loss should be 0 to 40 dB at the Nyquist frequency.

Note : Bearer rate	Nyquist Frequency
3.2kbit/s	1.6kHz
6.4kbit/s	3.2kHz
12.8kbit/s	6.4kHz
64kbit/s	32kHz

4.2.4.5 Sinusoidal Crosstalk Margin (S/X)

The S/X of DCE should be \leq 15dB (attenuator 2) for the test shown in Figure 4-6/JJ-50.10. The error has to be \leq 1 for one minute.

4.2.5 Electrical Environmental Conditions

For further study.

[Measurement System]

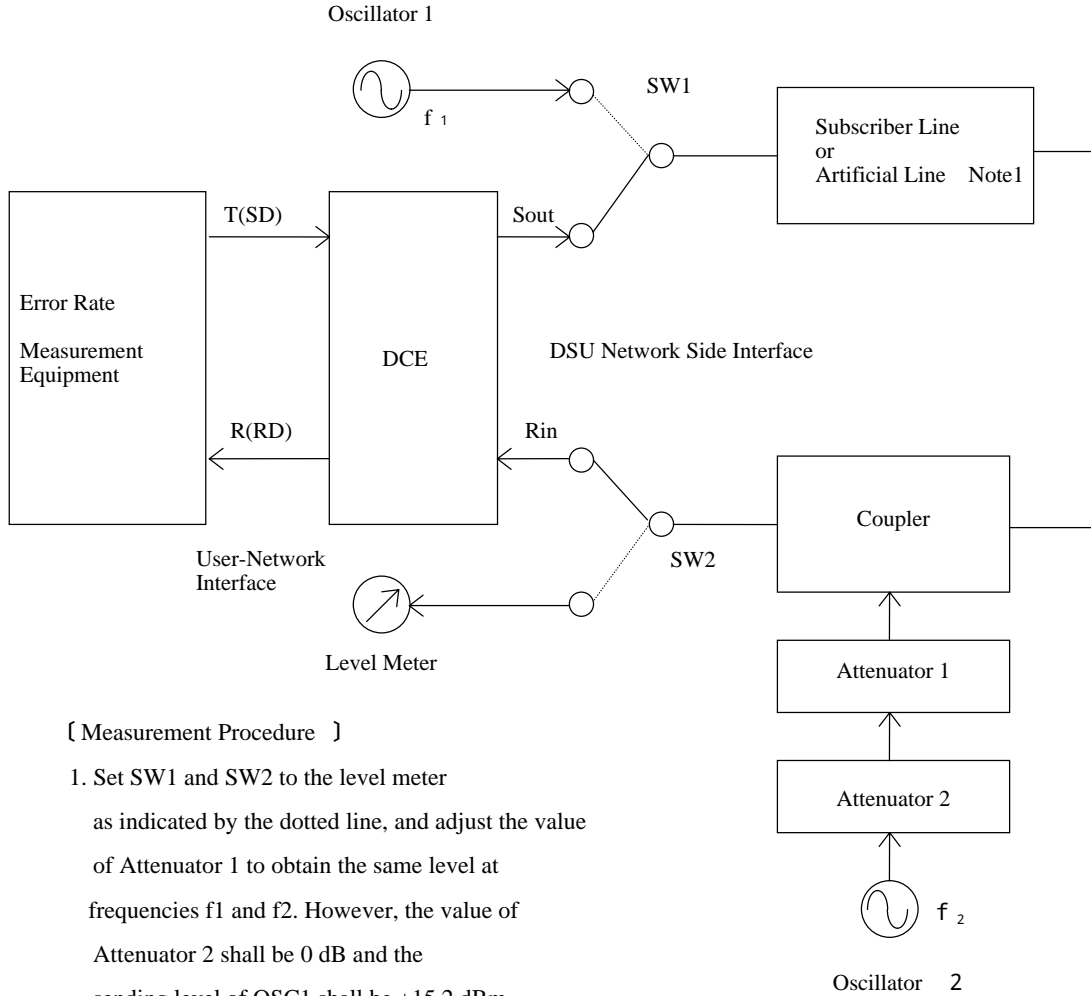

[Measurement Procedure]

1. Set SW1 and SW2 to the level meter as indicated by the dotted line, and adjust the value of Attenuator 1 to obtain the same level at frequencies f_1 and f_2 . However, the value of Attenuator 2 shall be 0 dB and the sending level of OSC1 shall be +15.2 dBm with 110 termination. Also, frequencies f_1 and f_2 should be as indicated in the TABLE (Bearer Rate) below.

2. Set SW1 and SW2 to the real line side and determine the error rate using the values of Attenuator 2. The measurement time shall be approximately one minute and the measurement pattern shall be an artificial random pattern.

TABLE (Bearer Rate)

	3.2 kbit/s	6.4 kbit/s	12.8 kbit/s	64 kbit/s
f_1	1.6 kHz	3.2 kHz	6.4 kHz	32 kHz
f_2	1.7 kHz	3.3 kHz	6.5 kHz	33 kHz

Note 1: The measurement shall be conducted with a subscriber line. But, if the subscriber line is not available, the artificial line shown in Table 4-2/JJ-50.10 may be used. Line and are used for the 3.2kbit/s bearer rate. Line and V for 6.4kbit/s, and Line , , and for 64kbit/s.

Note 2: Independent clock is available if needed.

Figure 4-6/JJ-50.10 Laboratory Test Set-up for the S/X measurement

Table 4-2/JJ-50.10 Artificial Line Loss Characteristics [dB] (Note)

frequency(kHz)	0.1	0.5	1.6	3.2	6.4	10	20	32	50	100
Line	5.0	5.0	5.0	5.1	5.1	5.2	5.3	5.6	6.2	7.9
Line	10.5	10.6	11.6	13.6	17.8	21.0	24.0	24.0	26.2	30.1
Line	16.3	16.5	17.7	20.3	25.0	28.9	35.7	40.0	44.3	52.9
Line	20.1	21.0	25.6	31.6	40.0	47.1	58.7			
Line	22.2	24.3	31.7	40.0	52.1					
Line	24.6	28.8	40.0	51.5						

Note 1: Impedance 110

Note 2: Allowable deviation $\pm 5\%$

Note 3: The artificial line loss characteristics that this table is based on is shown in Figure 4-7/JJ-50.10 Line is the metallic cable with bridged-tap.

4.2.6 Interconnecting Media Characteristics

4.2.6.1 Subscriber Line Characteristics

The typical line loss characteristics for metallic cable without a bridged-tap (BT) are shown in Figure 4-8/JJ-50.10. The deviation range is also shown in Figure 4-9/JJ-50.10.

Note: BT is an open-ended branch-line

4.2.6.2 Bridged-Tap Condition

The bridged-tap conditions are shown in table 4-3/JJ-50.10 for the receiving rule of the DCE.

Table 4-3/JJ-50.10 Bridged-Tap Conditions

BT length (Note)	number of BTs
500m	3 or less
1km	2 or less
2km	1 or less

Note: A BT length of 500 meters means the longest BT per subscriber is 500 meters or less.

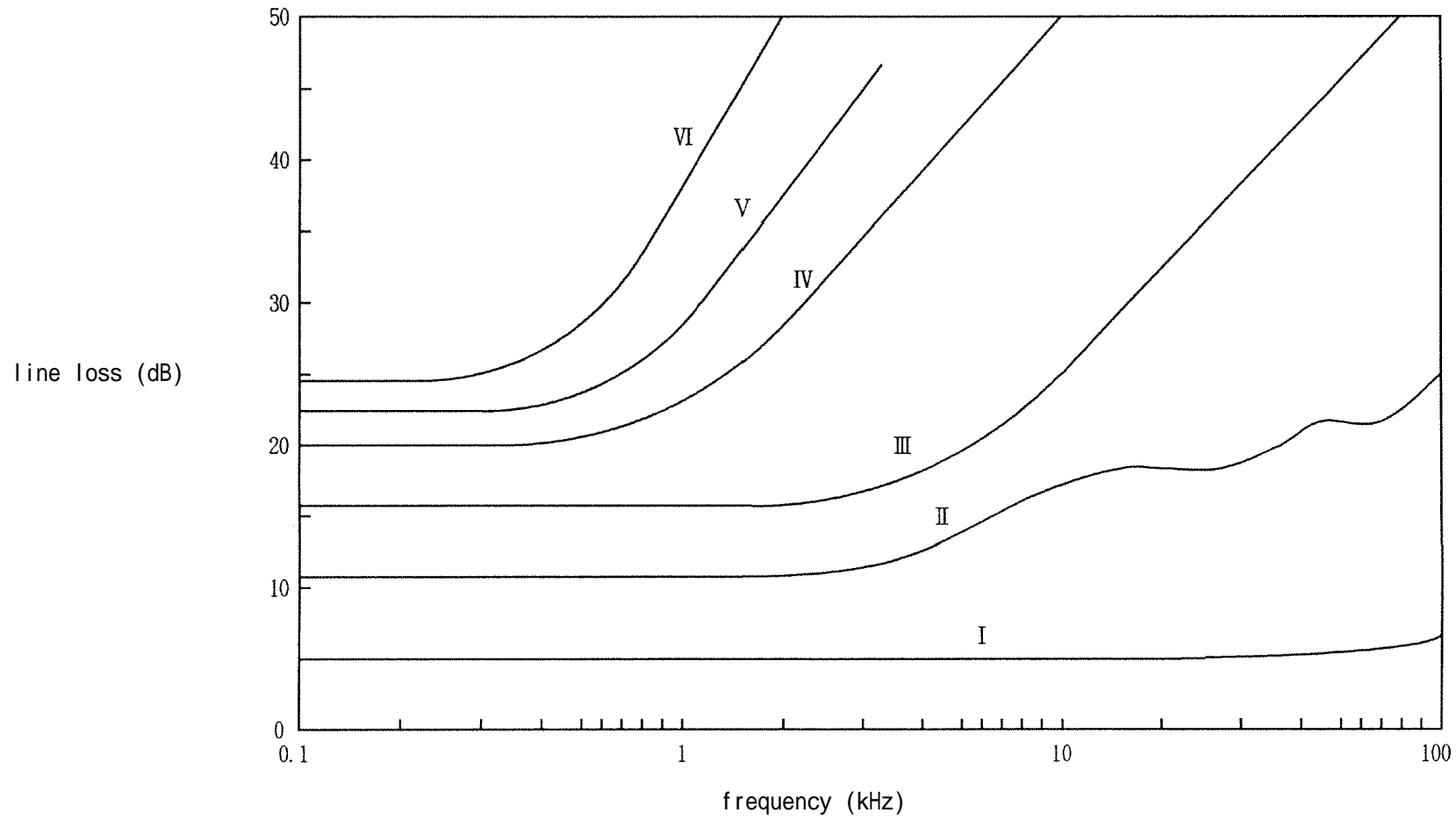

Figure 4-7/JJ-50.10 Artificial Line Loss Characteris

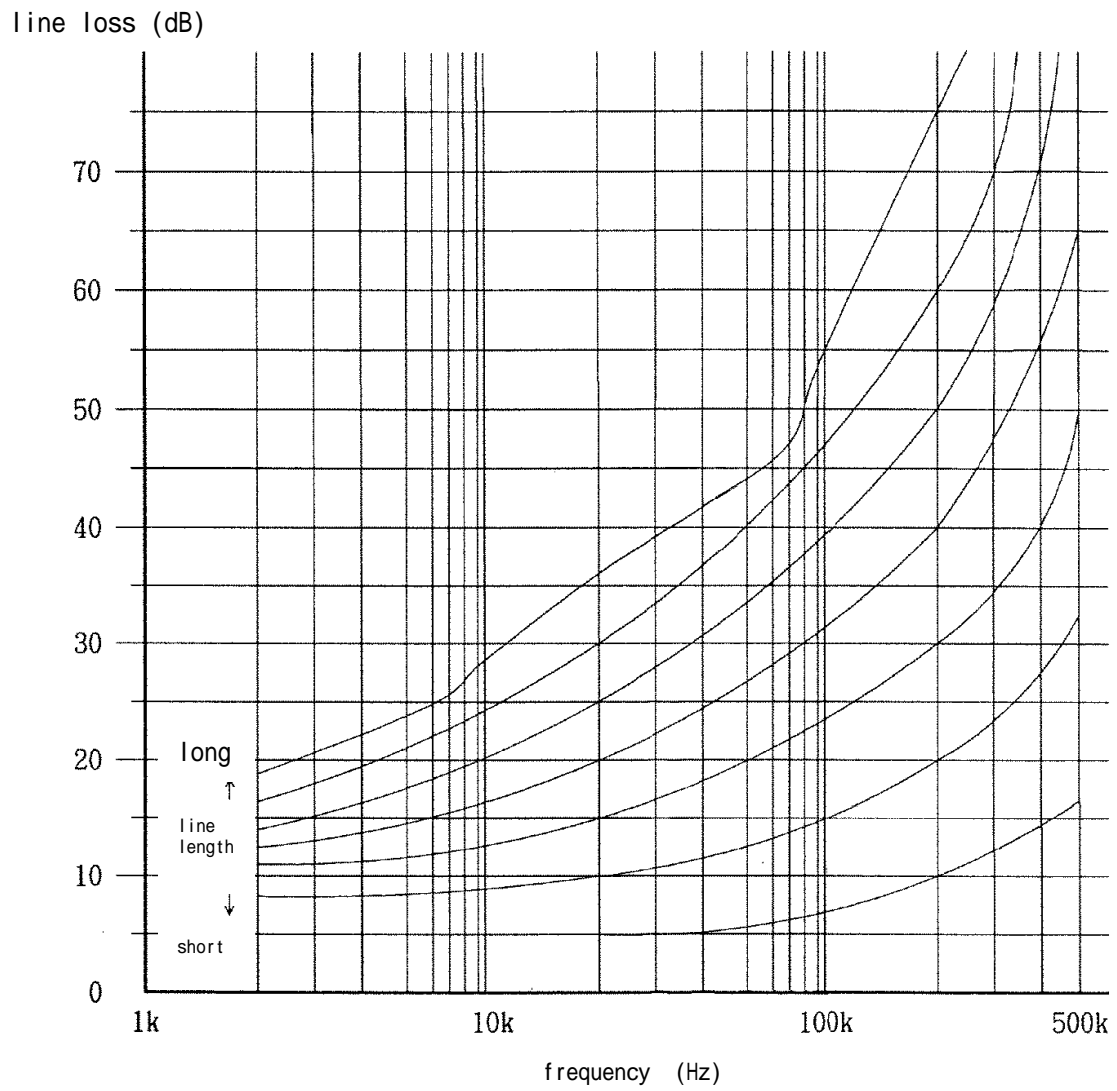

Figure 4-8/JJ-50.10 typical line loss without BT

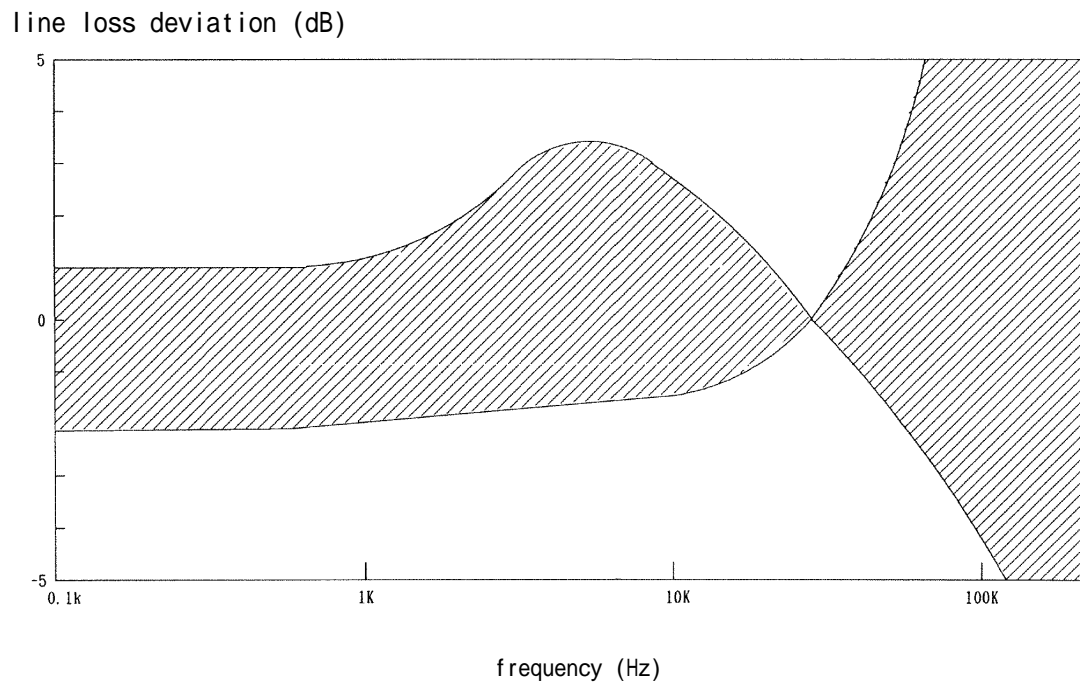

Figure 4-9/JJ-50.10 typical line loss deviation

5 . M a i n t e n a n c e

5.1 Loop Back Testing

The principles of maintenance for the digital data networks are specified in ITU-T Rec. X.150. The detailed descriptions on the loop back testing specified in X.150 are shown in ITU-T Rec. X.20, X.20bis, X.21, X.21bis and those outlined in Appendix 3.

Among the test loops specified in ITU-T X.150, this standard specifies those that are controlled by the network and are necessary for the distinction of troubles of the subscriber line, DCE and DTE, as shown in Figure 5-1/JJ-50.10.

(1) Automatic Loop Back 4a

Loop back 4a is formed by the specified direct current fed from the network in the phantom circuit which consists of input/output line of DCE, as shown in Figure 5-2/JJ-50.10. The conditions for the loop back controls are shown in Table 5-1/JJ-50.10.

(2) Automatic Loop Back 2b

Loop back 2b is formed when the DCE receives the control signal from the receiver line by the activation from the network. The conditions for the loop back controls are shown in Table 5-1/JJ-50.10.

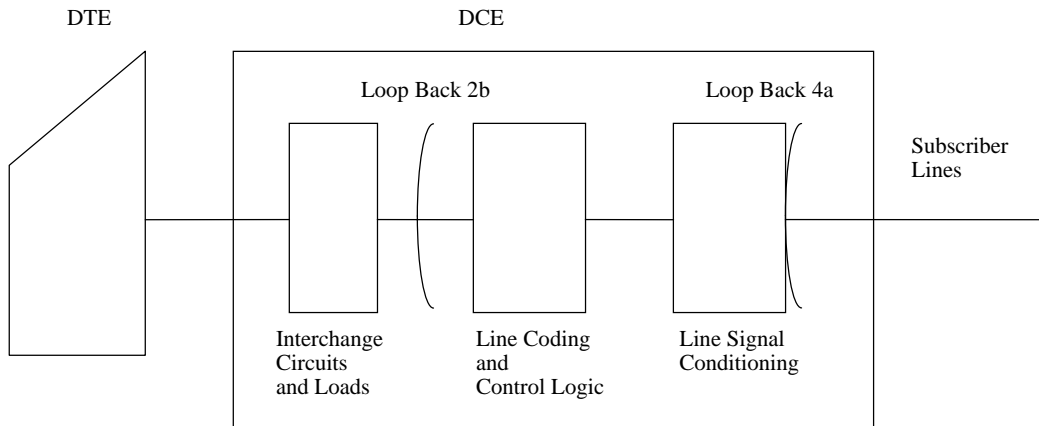

Figure 5-1/JJ-50.10 Loop back testing

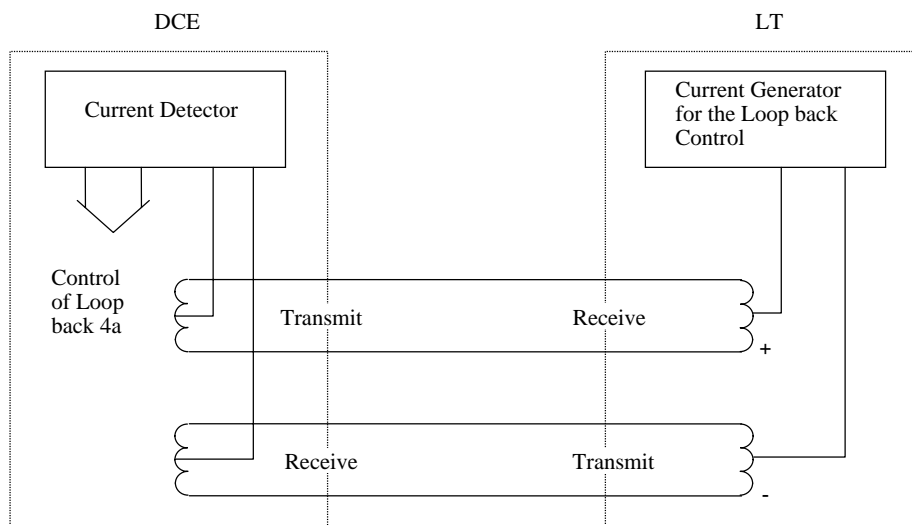

Figure 5-2/JJ-50.10 Control Method of Loop back 4a

Table 5-1/JJ-50.10 Conditions for the loop back controls

Name	Control methods from the network	
Automatic Loop Back 2b	Form the loop back	Transmit more than 3 consecutive envelopes of the loop back code [F1001000] .
	Keep the loop back state	Transmit more than one envelope of the loop back code out of 15 envelopes.
	Release the loop back	Transmit 15 envelopes including no envelope of the loop back code.
Automatic Loop Back 4a	Form and keep the loop back state	Feed direct current in the range of 11 ~ 15mA.
	Release the loop back	Stop direct current. (Note)

Note: DCE should return to the normal state within 3 seconds after detection of a loop back clear request.

5.2 Indication of trouble conditions

Frame patterns indicating trouble conditions at the subscriber transmission systems are shown in Table 5-2/JJ-50.10.

Table 5-2/JJ-50.10 Indication of trouble conditions

Definitions		Frame patterns
DCE Not Ready (DNR)	Notify DCE that communication capability is lost at the network	F0000000 (from network to DCE)
Uncontrol Not Ready (UNR)	Notify remote DTE that communication capability is lost at the DTE-DCE interface	F0010100 (from DCE to network)

Appendix 1: Definitions of signals in the
interface between DTE and DCE
(for TTC standard JJ-50.10)

Table A1-1/JJ-50.10 For ITU-T Rec. X.20

Interchange circuit	Abbreviation in X.20	Direction		Pin No.		Description
		DTE	DCE	V.10	V.11	
Protective Ground (FG)	/	—————		1	1	mechanical or frame ground
Signal Ground (G)	G	—————		8	8	supply reference voltage to all interconnecting circuits except FG
DTE common return (Ga)	Ga	—————		9	9	
DCE common return (Gb)	Gb	—————		11	11	
Transmit (T)	T	—————>		2	A 2	Transmitted data signal
					B 9	
Receive (R)	R	<—————		4	A 4	Received data signal
					B 11	

Table A1-2/JJ-50.10 For ITU-T Rec. X.21

Interchange circuit	Abbreviation in X.21	Direction		Pin No.		Description
		DTE	DCE	V.10	V.11	
Protective Ground (FG)	/	—————		1	1	mechanical or frame ground
Signal Ground (G)	G	—————		8	8	supply reference voltage to all interconnecting circuits except FG
Transmit (T)	T	—————>		2	A 2	Transmitted data signal
					B 9	
Receive (R)	R	<—————		4	A 4	Received data signal
					B 11	
Control (C)	C	—————>		3	A 3	Indication of condition ON : Connected phase OFF: Disconnected phase
					B 10	
Indication (I)	I	<—————		A 5	A 5	control information ON :Received data from other terminal OFF:Received control data from network
				B 12	B 12	
Signal Element Timing (S)	S	<—————		A 6	A 6	Timing for synchronization
				B 13	B 13	
Transmitting Timing (ST ₂)	/	<—————		A 7	A 7	Used in single test of DCE Usually OFF, alternately ON or OFF only when independent synchronization is established
				B 14	B 14	

Table A1-3/JJ-50.10 For ITU-T X.20bis and X.21bis
(applied at less than 9600b/s) (Note)

Interchange circuit	Circuit code in V.24	Direction		Pin No.	Description
		DTE	DCE		
Protective Ground (FG)		—————		1	mechanical or frame ground
Signal Ground (SG)	102	—————		7	supply reference voltage to all interconnecting circuits except FG
Transmitted Data (SD)	103	—————>		2	Transmitted data from DTE to DCE
Received Data (RD)	104	<—————		3	Transmitted data from DCE to DTE
Request to Send (RS)	105	—————>		4	ON : Request to send data OFF: Request not to send data
Ready for Sending (CS)	106	<—————		5	ON : Request for sending data OFF: Not ready for sending data
Data Set Ready (DR) (Indication of DCE Condition)	107	<—————		6	ON : DCE ready for sending/receiving data OFF: DCE not ready for sending/receiving data
Connect Data Set to Line (CDL)	108/1	—————>		20	ON : Enable DCE to send data OFF: Disable DCE to send data (alternatively used ER or CDL)
Data Terminal Ready (ER)	108/2				
Data Channel Received Line Signal Detector (CD)	109	<—————		8	ON : Receiving transmitted data OFF: Signal off
Transmitter Signal Element Timing (ST ₂)	114	<—————		15	Transmitted data timing for synchronization
Receiver Signal Element Timing (RT)	115	<—————		17	Received data timing for synchronization
Test Indicator (TI)	142	<—————		25	ON : Testing OFF: Not testing

Note: Functional specifications are based on ITU-T Rec. V.24.

Table A1-4/JJ-50.10 For ITU-T X.21bis

(applied to 48kb/s) (Note)

Interchange circuit	Circuit code in V.35	Direction		Pin No.		Description
		DTE	DCE			
Protective Ground (FG)		—————		A		mechanical or frame ground
Signal Ground (SG)	102	—————		B		supply reference voltage to all interconnecting circuits except FG
Transmitted Data (SD)	103	—————>		A	P	Transmitted data from DTE to DCE
				B	S	
Received Data (RD)	104	<—————		A	R	Transmitted data from DCE to DTE
				B	T	
Request to Send (RS)	105	—————>		C		ON : DCE transmitting mode OFF: DCE non-transmitting mode
Ready for Sending (CS)	106	<—————		D		ON : DCE ready for sending OFF: DCE not ready for sending
Data set Ready (DR)	107	<—————		E		ON : DTE ready for data OFF: DTE not ready for data
Connect Data Set to Line (CDL)	108/1	—————>		H		ON : Enable DCE to send OFF: Disable DCE to send (alternatively used ER or CDL)
Data terminal Ready (ER)	108/2	—————>				
Data Channel Received Line Signal Detector (CD)	109	<—————		F		ON : Receiving transmitted data OFF: Signal off
Transmitter Signal Element Timing (ST ₂)	114	<—————		A	Y	Transmitted data timing for synchronization
				B	AA	
Receiver Signal Element Timing (RT)	115	<—————		A	V	Received data timing for synchronization
				B	X	

Note: Functional specifications are based on ITU-T Rec. V.35.

Appendix 2: The definition of the loops
for ITU-T Rec. X.150
(based on TTC standard JJ-50.10)

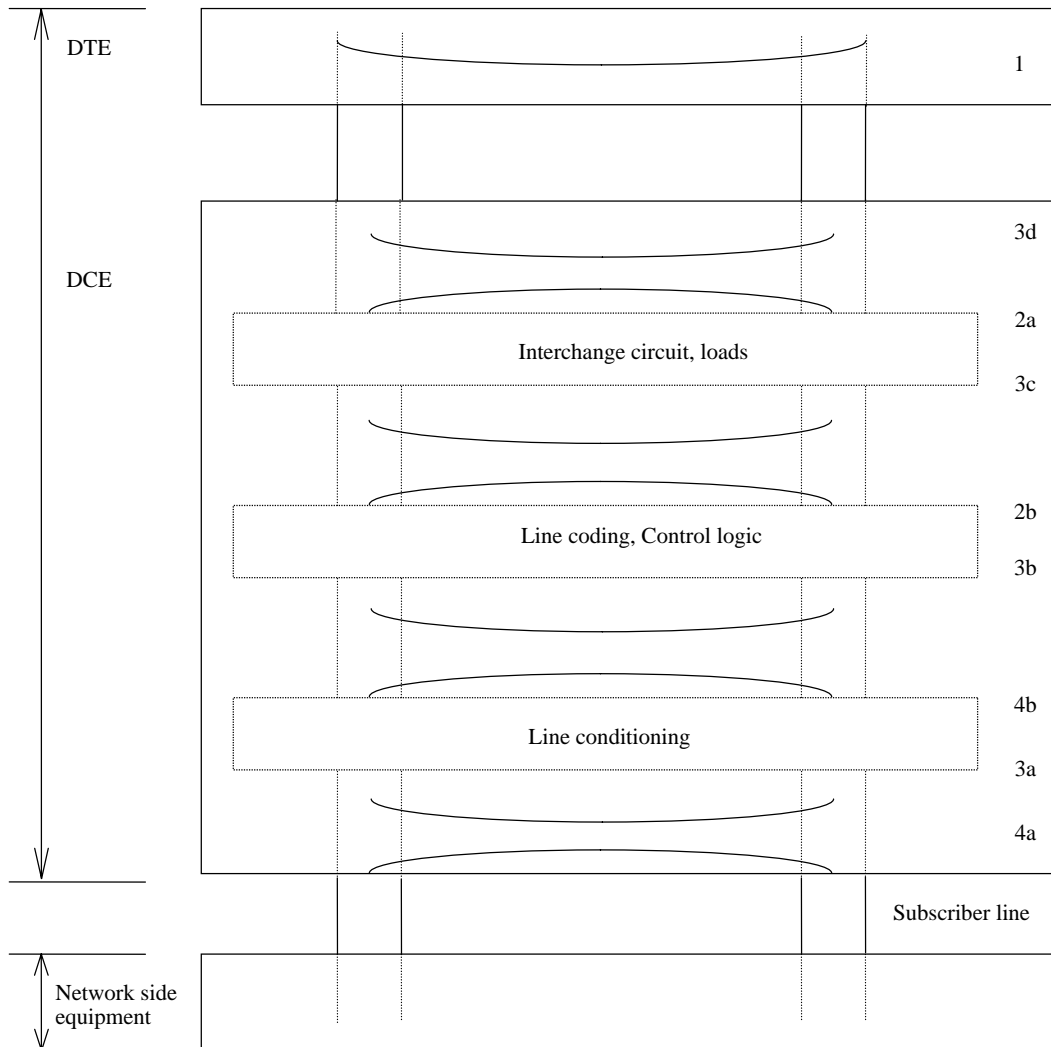

Note: The back-to-back loops (e.g. 3d/2a, 3c/2b, 3b/4b and 3a/4a) that are provided should be configured in such a manner that there is no active equipment between the loopbacks. For example: network side equipment may operate the back-to-back loopbacks simultaneously in the relay or switch.

Figure A2-1/JJ-50.10 Test loops are defined by ITU-T Rec. X.150
(Figure 1/ITU-T X.150)

Table A2-1/JJ-50.10 Performance outlines of test loops in ITU-T Rec. X.150

Type of loops (Refer to Figure A2-1)	Main purpose	Loop backs form	Control point	Control method	Equipment
(1) Type 1 loop • loop 1	For inside check of individual DTE.	Digital loop backs between transmitting line and receiving line. (As close as possible to the interface.)	DTE	Control inside the DTE.	Necessary for New DTE
(2) Type 2 loops • loop 2a • loop 2b	For DCE check by network provider.	Digital loop backs.	Manual control or remote control from network side.	Control method from network side is decided by each country.	Only one is necessary.
(3) Type 3 loops • loop 3a • loop 3b • loop 3c • loop 3d	For local test of DCE.	• Analogue loop backs between transmitting line and receiving line. loop 3a, loop 3d • Digital loop backs between transmitting line and receiving line. loop 3b, loop 3c	Inside the DCE in manual case, DTE in automatic case.	Manual or automatic. (Control method is decided by each country.)	Everyone is necessary.
(3) Type 4 loops • loop 4a • loop 4b	For circuit maintenance by network provider.	Analogue loop backs between transmitting line and receiving line.	It is decided by each country.		It is provided by each country.

Digital Transmission System for Metallic Local Lines in the Public Data Networks

(English Edition)

April 23, 1997

TTC Original Standards [JJ-50.10]

Version 3

Copyright © 1997

THE TELECOMMUNICATION TECHNOLOGY COMMITTEE (TTC)

All rights reserved.

THE TELECOMMUNICATION TECHNOLOGY COMMITTEE (TTC)

Hamamatsu-cho Suzukibuilding 1-2-11, Hamamatsu-cho, Minato-ku,

TOKYO 105-0013, JAPAN

TEL ; + 81 3 3432 1551 FAX ; + 81 3 3432 1553
