

TS-M2M-0001v2.18.1

oneM2M 技術仕様書
機能アーキテクチャ

oneM2M Technical Specification
Functional Architecture

2018年5月11日制定

一般社団法人

情報通信技術委員会

THE TELECOMMUNICATION TECHNOLOGY COMMITTEE

本書は、一般社団法人情報通信技術委員会が著作権を保有しています。
内容の一部又は全部を一般社団法人情報通信技術委員会の許諾を得ることなく複製、
転載、改変、転用及びネットワーク上での送信、配布を行うことを禁止します。

<参考> [Remarks]

1. 英文記述の適用レベル [Application level of English description]

適用レベル [Application level] : E2

本標準の本文、付属資料および付録の文章および図に英文記述を含んでいる。

[English description is included in the text and figures of main body, annexes and appendices.]

2. 国際勧告等の関連 [Relationship with international recommendations and standards]

本標準は、oneM2M で承認された Technical Specification 0001V2.18.1 に準拠している。

[This standard is standardized based on the Technical Specification 0001 (V2.18.1) approved by oneM2M.]

3. 上記国際勧告等に対する追加項目等 [Departures from international recommendations]

原標準に対する変更項目 [Changes to original standard]

原標準が参照する標準のうち、TTC 標準に置き換える項目。

[Standards referred to in the original standard, which are replaced by TTC standards.]

原標準が参照する標準のうち、それらに準拠した TTC 標準等が制定されている場合は自動的に最新版 TTC 標準等に置き換え参照するものとする。

[Standards referred to in the original standard should be replaced by derived TTC standards.]

4. 工業所有権 [IPR]

本標準に関わる「工業所有権等の実施の権利に係る確認書」の提出状況は、TTC ホームページによる。

[Status of “Confirmation of IPR Licensing Condition” submitted is provided in the TTC web site.]

5. 作成専門委員会 [Working Group]

oneM2M 専門委員会 [oneM2M Working Group]



ONEM₂M TECHNICAL SPECIFICATION

Document Number	oneM2M -TS-0001-V2.18.1
Document Name:	Functional Architecture
Date:	2018-03-12
Abstract:	This document specifies the functional architecture for the oneM2M Services Platform.

The present document is provided for future development work within oneM2M only. The Partners accept no liability for any use of this specification.

The present document has not been subject to any approval process by the oneM2M Partners Type 1. Published oneM2M specifications and reports for implementation should be obtained via the oneM2M Partners' Publications Offices.

About oneM2M

The purpose and goal of oneM2M is to develop technical specifications which address the need for a common M2M Service Layer that can be readily embedded within various hardware and software, and relied upon to connect the myriad of devices in the field with M2M application servers worldwide.

More information about oneM2M may be found at: <http://www.oneM2M.org>

Copyright Notification

© 2018, oneM2M Partners Type 1 (ARIB, ATIS, CCSA, ETSI, TIA, TSDSI, TTA, TTC).

All rights reserved.

The copyright extends to reproduction in all media.

Notice of Disclaimer & Limitation of Liability

The information provided in this document is directed solely to professionals who have the appropriate degree of experience to understand and interpret its contents in accordance with generally accepted engineering or other professional standards and applicable regulations. No recommendation as to products or vendors is made or should be implied.

NO REPRESENTATION OR WARRANTY IS MADE THAT THE INFORMATION IS TECHNICALLY ACCURATE OR SUFFICIENT OR CONFORMS TO ANY STATUTE, GOVERNMENTAL RULE OR REGULATION, AND FURTHER, NO REPRESENTATION OR WARRANTY IS MADE OF MERCHANTABILITY OR FITNESS FOR ANY PARTICULAR PURPOSE OR AGAINST INFRINGEMENT OF INTELLECTUAL PROPERTY RIGHTS. NO oneM2M PARTNER TYPE 1 SHALL BE LIABLE, BEYOND THE AMOUNT OF ANY SUM RECEIVED IN PAYMENT BY THAT PARTNER FOR THIS DOCUMENT, WITH RESPECT TO ANY CLAIM, AND IN NO EVENT SHALL oneM2M BE LIABLE FOR LOST PROFITS OR OTHER INCIDENTAL OR CONSEQUENTIAL DAMAGES. oneM2M EXPRESSLY ADVISES ANY AND ALL USE OF OR RELIANCE UPON THIS INFORMATION PROVIDED IN THIS DOCUMENT IS AT THE RISK OF THE USER.

Contents

1	Scope	14
2	References	14
2.1	Normative references	14
2.2	Informative references	14
3	Definitions and abbreviations.....	16
3.1	Definitions	16
3.2	Abbreviations.....	17
4	Conventions.....	20
5	Architecture Model	21
5.1	General Concepts.....	21
5.2	Architecture Reference Model.....	22
5.2.1	Functional Architecture.....	22
5.2.2	Reference Points.....	23
5.2.2.0	Overview	23
5.2.2.1	Mca Reference Point	23
5.2.2.2	Mcc Reference Point	23
5.2.2.3	Mcn Reference Point	23
5.2.2.4	Mcc' Reference Point.....	23
5.2.2.5	Other Reference Points and Interfaces	23
6	oneM2M Architecture Aspects	24
6.1	Configurations supported by oneM2M Architecture	24
6.2	Common Services Functions	26
6.2.0	Overview	26
6.2.1	Application and Service Layer Management	26
6.2.1.1	General Concepts.....	26
6.2.1.2	Detailed Descriptions	27
6.2.1.2.0	Overview.....	27
6.2.1.2.1	Software Management Function	27
6.2.2	Communication Management and Delivery Handling.....	27
6.2.2.1	General Concepts.....	27
6.2.2.2	Detailed Descriptions	28
6.2.3	Data Management and Repository	28
6.2.3.1	General Concepts.....	28
6.2.3.2	Detailed Descriptions	29
6.2.4	Device Management.....	29
6.2.4.1	General Concepts.....	29
6.2.4.1.0	Overview.....	29
6.2.4.1.1	Device Management Architecture	29
6.2.4.1.2	Management Server Interaction	30
6.2.4.1.3	Management Client Interaction.....	32
6.2.4.1.4	Device Management Resource Lifecycle.....	33
6.2.4.2	Detailed Descriptions	33
6.2.4.2.0	Overview.....	33
6.2.4.2.1	Device Configuration Function.....	34
6.2.4.2.2	Device Diagnostics and Monitoring Function	34
6.2.4.2.3	Device Firmware Management Function.....	35
6.2.4.2.4	Device Topology Management Function.....	35
6.2.5	Discovery	35
6.2.5.1	General Concepts.....	35
6.2.5.2	Detailed Descriptions	35
6.2.6	Group Management.....	36
6.2.6.1	General Concepts.....	36
6.2.6.2	Detailed Descriptions	36
6.2.7	Location	36
6.2.7.1	General Concepts.....	36

6.2.7.2	Detailed Descriptions	37
6.2.8	Network Service Exposure, Service Execution and Triggering	37
6.2.8.1	General Concepts.....	37
6.2.8.2	Detailed Descriptions	37
6.2.9	Registration	38
6.2.9.1	General Concepts.....	38
6.2.9.2	Detailed Descriptions	38
6.2.10	Security	39
6.2.10.1	General Concepts.....	39
6.2.10.2	Detailed Descriptions	39
6.2.11	Service Charging and Accounting.....	41
6.2.11.1	General Concepts.....	41
6.2.11.2	Detailed Descriptions	41
6.2.12	Subscription and Notification.....	41
6.2.12.1	General Concepts.....	41
6.2.12.2	Detailed Descriptions	42
6.3	Security Aspects	42
6.4	Intra-M2M SP Communication	42
6.5	Inter-M2M SP Communication	43
6.5.1	Inter M2M SP Communication for oneM2M Compliant Nodes.....	43
6.5.1.0	Overview	43
6.5.1.1	Public Domain Names and CSEs	44
6.5.2	Inter M2M SP Generic Procedures	44
6.5.2.0	Overview	44
6.5.2.1	Actions of the Originating M2M Node in the Originating Domain	44
6.5.2.2	Actions of the Receiving CSE in the Originating Domain	44
6.5.2.3	Actions in the IN of the Target Domain	45
6.5.3	DNS Provisioning for Inter-M2M SP Communication.....	45
6.5.3.0	Overview	45
6.5.3.1	Inter-M2M SP Communication Access Control Policies	45
6.5.4	Conditional Inter-M2M Service Provider CSE Registration.....	45
6.6	M2M Service Subscription	46
7	M2M Entities and Object Identification.....	46
7.1	M2M Identifiers.....	46
7.1.0	Overview	46
7.1.1	M2M Service Provider Identifier (M2M-SP-ID)	46
7.1.2	Application Entity Identifier (AE-ID).....	46
7.1.3	Application Identifier (App-ID).....	47
7.1.4	CSE Identifier (CSE-ID).....	47
7.1.5	M2M Node Identifier (M2M-Node-ID).....	47
7.1.6	M2M Service Subscription Identifier (M2M-Sub-ID).....	47
7.1.7	M2M Request Identifier (M2M-Request-ID).....	48
7.1.8	M2M External Identifier (M2M-Ext-ID)	48
7.1.9	Underlying Network Identifier (UNetwork-ID).....	49
7.1.10	Trigger Recipient Identifier (Trigger-Recipient-ID).....	49
7.1.11	Void.....	49
7.1.12	Void.....	49
7.1.13	M2M Service Profile Identifier (M2M-Service-Profile-ID)	49
7.1.14	Role Identifier (Role-ID).....	49
7.1.15	Token Identifier (Token-ID)	49
7.1.16	Local Token Identifier (Local-Token-ID).....	50
7.2	M2M-SP-ID, CSE-ID, App-ID and AE-ID and resource Identifier formats	50
7.3	M2M Identifiers lifecycle and characteristics.....	59
8	Description and Flows of Reference Points	61
8.1	General Communication Flow Scheme on Mca and Mcc Reference Points.....	61
8.1.0	Overview	61
8.1.1	Description	61
8.1.2	Request.....	61
8.1.3	Response	71
8.2	Procedures for Accessing Resources	75

8.2.0	Overview	75
8.2.1	Accessing Resources in CSEs - Blocking Requests	75
8.2.1.0	Overview	75
8.2.1.1	M2M Requests Routing Policies	80
8.2.2	Accessing Resources in CSEs - Non-Blocking Requests.....	80
8.2.2.1	Response with Acknowledgement and optional Reference to Request Context and Capturing Result of Requested Operation	80
8.2.2.2	Synchronous Case	80
8.2.2.3	Asynchronous Case	83
8.3	Procedures for interaction with Underlying Networks	84
8.3.1	Introduction	84
8.3.2	Description and Flows on Mcn Reference Point	85
8.3.3	Device Triggering	85
8.3.3.1	Definition and scope.....	85
8.3.3.2	General Procedure for Device Triggering	85
8.3.3.2.0	Overview.....	85
8.3.3.2.1	Triggering procedure for targeting ASN/MN-CSE.....	86
8.3.3.2.2	Support for device trigger recall/replace procedure	87
8.3.4	Location Request.....	89
8.3.4.1	Definition and Scope	89
8.3.4.2	General Procedure for Location Request.....	89
8.3.5	Configuration of Traffic Patterns	91
8.3.5.1	Purpose of Configuration of Traffic Patterns	91
8.3.5.2	Traffic pattern parameters	91
8.3.5.3	General procedure for Configuration of Traffic Patterns.....	92
8.4	Connection Request	94
8.5	Device Management	94
9	Resource Management	94
9.0	Overview	94
9.1	General Principles.....	94
9.2	Resources.....	94
9.2.0	Overview	94
9.2.1	Normal Resources	95
9.2.2	Virtual Resources	95
9.2.3	Announced Resources	95
9.3	Resource Addressing	95
9.3.1	Generic Principles	95
9.3.2	Addressing an Application Entity	97
9.3.2.1	Application Entity Addressing	97
9.3.2.2	Application Entity Reachability	97
9.3.2.2.1	CSE Point of Access (CSE-PoA).....	97
9.3.2.2.2	Locating Application Entities	97
9.3.2.2.3	Usage of CSE-PoA by the M2M System.....	97
9.3.2.3	Notification Re-targeting.....	99
9.3.2.3.1	Application Entity Point of Access (AE-PoA).....	99
9.4	Resource Structure.....	100
9.4.1	Relationships between Resources	100
9.4.2	Link Relations	101
9.5	Resource Type Specification Conventions	101
9.5.0	Overview	101
9.5.1	Handling of Unsupported Resources/Attributes/Sub-resources within the M2M System	104
9.6	Resource Types.....	104
9.6.1	Overview	104
9.6.1.1	Resource Type Summary.....	104
9.6.1.2	Resource Type Specializations	111
9.6.1.2.1	Specializations of <mgmtObj>.....	111
9.6.1.2.2	Specializations of <flexContainer>.....	112
9.6.1.3	Commonly Used Attributes	115
9.6.1.3.0	Overview.....	115
9.6.1.3.1	Universal attributes	116
9.6.1.3.2	Common attributes.....	116

9.6.2	Resource Type <i>accessControlPolicy</i>	120
9.6.2.0	Introduction	120
9.6.2.1	<i>accessControlOriginators</i>	121
9.6.2.2	<i>accessControlContexts</i>	122
9.6.2.3	<i>accessControlOperations</i>	122
9.6.2.4	<i>accessControlObjectDetails</i>	123
9.6.2.5	<i>accessControlAuthenticationFlag</i>	123
9.6.3	Resource Type <i>CSEBase</i>	123
9.6.4	Resource Type <i>remoteCSE</i>	126
9.6.5	Resource Type <i>AE</i>	130
9.6.6	Resource Type <i>container</i>	134
9.6.7	Resource Type <i>contentInstance</i>	137
9.6.8	Resource Type <i>subscription</i>	139
9.6.9	Resource Type <i>schedule</i>	146
9.6.10	Resource Type <i>locationPolicy</i>	147
9.6.11	Resource Type <i>delivery</i>	150
9.6.12	Resource Type <i>request</i>	152
9.6.13	Resource Type <i>group</i>	155
9.6.14	Resource Type <i>fanOutPoint</i>	157
9.6.14a	Resource Type <i>semanticFanOutPoint</i>	157
9.6.15	Resource Type <i>mgmtObj</i>	158
9.6.16	Resource Type <i>mgmtCmd</i>	160
9.6.17	Resource Type <i>execInstance</i>	162
9.6.18	Resource Type <i>node</i>	163
9.6.19	Resource Type <i>m2mServiceSubscriptionProfile</i>	169
9.6.20	Resource Type <i>serviceSubscribedNode</i>	170
9.6.21	Resource Type <i>pollingChannel</i>	172
9.6.22	Resource Type <i>pollingChannelURI</i>	172
9.6.23	Resource Type <i>statsConfig</i>	173
9.6.24	Resource Type <i>eventConfig</i>	173
9.6.25	Resource Type <i>statsCollect</i>	176
9.6.26	Resource Announcement.....	177
9.6.26.1	Overview	177
9.6.26.2	Universal Attributes for Announced Resources	181
9.6.26.3	Common Attributes for Announced Resources	181
9.6.27	Resource Type <i>latest</i>	181
9.6.28	Resource Type <i>oldest</i>	182
9.6.29	Resource Type <i>serviceSubscribedAppRule</i>	182
9.6.30	Resource Type <i>semanticDescriptor</i>	183
9.6.31	Resource Type <i>notificationTargetMgmtPolicyRef</i>	185
9.6.32	Resource Type <i>notificationTargetPolicy</i>	186
9.6.33	Resource Type <i>policyDeletionRules</i>	188
9.6.34	Resource Type <i>notificationTargetSelfReference</i>	189
9.6.35	Resource Type <i>flexContainer</i>	190
9.6.36	Resource Type <i>timeSeries</i>	192
9.6.37	Resource Type <i>timeSeriesInstance</i>	194
9.6.38	Resource Type <i>role</i>	195
9.6.39	Resource Type <i>token</i>	196
9.6.40	Resource Type <i>dynamicAuthorizationConsultation</i>	198
9.6.41	Resource Type <i>trafficPattern</i>	199
10	Information Flows	202
10.1	Basic Procedures.....	202
10.1.0	Overview	202
10.1.1	CREATE (C).....	202
10.1.1.0	Introduction	202
10.1.1.1	Non-registration related CREATE procedure.....	202
10.1.1.2	Registration related CREATE procedure	204
10.1.1.2.0	Overview.....	204
10.1.1.2.1	CSE Registration procedure.....	204
10.1.1.2.2	Application Entity Registration procedure.....	205
10.1.2	RETRIEVE (R).....	210

10.1.3	UPDATE (U)	211
10.1.4	DELETE (D)	212
10.1.4.0	Introduction	212
10.1.4.1	Non-deregistration related DELETE procedure	213
10.1.4.2	Deregistration related DELETE procedure.....	213
10.1.4.2.0	Overview.....	213
10.1.4.2.1	CSE Deregistration procedure	213
10.1.4.2.2	Application Entity Deregistration procedure	214
10.1.5	NOTIFY (N)	214
10.2	Resource Type-Specific Procedures	215
10.2.0	Overview	215
10.2.1	<AE> Resource Procedures	216
10.2.1.1	Create <AE>	216
10.2.1.2	Retrieve <AE>	216
10.2.1.3	Update <AE>	217
10.2.1.4	Delete <AE>	217
10.2.1.5	Notify <AE>	218
10.2.2	<remoteCSE> Resource Procedures.....	218
10.2.2.1	Create <remoteCSE>	218
10.2.2.2	Retrieve <remoteCSE>	219
10.2.2.3	Update <remoteCSE>	219
10.2.2.4	Delete <remoteCSE>	220
10.2.3	<CSEBase> Resource Procedures	220
10.2.3.1	Create <CSEBase>	220
10.2.3.2	Retrieve <CSEBase>	220
10.2.3.3	Update <CSEBase>	220
10.2.3.4	Delete <CSEBase>	221
10.2.3.5	Notify <CSEBase>	221
10.2.4	<container> Resource Procedures.....	221
10.2.4.1	Create <container>	221
10.2.4.2	Retrieve <container>	222
10.2.4.3	Update <container>	222
10.2.4.4	Delete <container>	223
10.2.5	Access to Remotely Hosted Resources via <delivery>	223
10.2.5.1	Introduction to usage of <delivery> resource type	223
10.2.5.2	Create <delivery>	226
10.2.5.3	Retrieve <delivery>	228
10.2.5.4	Update <delivery>	228
10.2.5.5	Delete <delivery>	229
10.2.6	Resource Discovery Procedures.....	230
10.2.6.1	Introduction	230
10.2.6.2	Discovery procedure via Retrieve Operation.....	230
10.2.7	Group Management Procedures	231
10.2.7.1	Introduction	231
10.2.7.2	Create <group>	231
10.2.7.3	Retrieve <group>.....	233
10.2.7.4	Update <group>.....	234
10.2.7.5	Delete <group>.....	235
10.2.7.6	<fanOutPoint> Management Procedures.....	236
10.2.7.7	Create <fanOutPoint>.....	237
10.2.7.8	Retrieve <fanOutPoint>	239
10.2.7.9	Update <fanOutPoint>	240
10.2.7.10	Delete <fanOutPoint>.....	242
10.2.7.11	Subscribe and Un-Subscribe <fanOutPoint> of a group	244
10.2.7.12	Aggregate the Notifications by group.....	246
10.2.7.13	<semanticFanOutPoint> Procedures.....	247
10.2.7.14	Retrieve <semanticFanOutPoint>	247
10.2.8	<mgmtObj> Resource Procedures	248
10.2.8.1	Introduction	248
10.2.8.2	Create <mgmtObj>	249
10.2.8.3	Retrieve <mgmtObj>	251
10.2.8.4	Update <mgmtObj>	251

10.2.8.5	Delete <mgmtObj>	252
10.2.8.6	Execute <mgmtObj>	254
10.2.9	External Management Operations through <mgmtCmd>	254
10.2.9.1	Introduction	254
10.2.9.2	Create <mgmtCmd>	255
10.2.9.3	Retrieve <mgmtCmd>	255
10.2.9.4	Update <mgmtCmd>	256
10.2.9.5	Delete <mgmtCmd>	256
10.2.9.6	Execute <mgmtCmd>	258
10.2.9.7	Cancel <execInstance>	259
10.2.9.8	Retrieve <execInstance>	260
10.2.9.9	Delete <execInstance>	261
10.2.10	Location Management Procedures	262
10.2.10.1	Procedure related to <locationPolicy> resource	262
10.2.10.1.0	Overview	262
10.2.10.1.1	Create <locationPolicy>	262
10.2.10.1.2	Retrieve <locationPolicy>	263
10.2.10.1.3	Update <locationPolicy>	264
10.2.10.1.4	Delete <locationPolicy>	264
10.2.10.2	Procedure when the <container> and <contentInstance> resource contain location information	265
10.2.10.2.0	Overview	265
10.2.10.2.1	Procedure for <container> resource that stores the location information	265
10.2.10.2.2	Procedure for <contentInstance> resource that stores location information	265
10.2.11	<subscription> Resource Procedures	266
10.2.11.1	Introduction	266
10.2.11.2	Create <subscription>	266
10.2.11.3	Retrieve <subscription>	267
10.2.11.4	Update <subscription>	267
10.2.11.5	Delete <subscription>	268
10.2.12	Notification Procedures for Resource Subscription	268
10.2.12.0	Overview	268
10.2.12.1	Procedure for Originator of Notifications and Hosting CSEs	268
10.2.12.2	Procedure for Target Receivers of Notifications	271
10.2.12.2.0	Overview	271
10.2.12.2.1	Notification Target removal handling procedure	272
10.2.13	Polling Channel Management Procedures	272
10.2.13.1	Introduction	272
10.2.13.2	Create <pollingChannel>	273
10.2.13.3	Retrieve <pollingChannel>	274
10.2.13.4	Update <pollingChannel>	274
10.2.13.5	Delete <pollingChannel>	275
10.2.13.6	Internal Processing for Polling Channel	275
10.2.13.7	Long Polling on Polling Channel	275
10.2.13.8	Delivering the response to the request sent over polling channel	276
10.2.14	<node> Resource Procedures	277
10.2.14.1	Create <node>	277
10.2.14.2	Retrieve <node>	277
10.2.14.3	Update <node>	278
10.2.14.4	Delete <node>	278
10.2.15	Service Charging and Accounting Procedures	278
10.2.15.1	Introduction	278
10.2.15.1.0	Overview	278
10.2.15.1.1	Service Event-based Statistics Collection for Applications	279
10.2.15.2	Create <statsConfig>	280
10.2.15.3	Retrieve <statsConfig>	281
10.2.15.4	Update <statsConfig>	281
10.2.15.5	Delete <statsConfig>	282
10.2.15.6	Create <eventConfig>	283
10.2.15.7	Retrieve <eventConfig>	283
10.2.15.8	Update <eventConfig>	283
10.2.15.9	Delete <eventConfig>	284
10.2.15.10	Create <statsCollect>	284

10.2.15.11	Retrieve <statsCollect>	285
10.2.15.12	Update <statsCollect>	285
10.2.15.13	Delete <statsCollect>	286
10.2.15.14	Service Statistics Collection Record.....	286
10.2.16	<m2mServiceSubscriptionProfile> Resource Procedures	287
10.2.16.1	Create <m2mServiceSubscriptionProfile>.....	287
10.2.16.2	Retrieve <m2mServiceSubscriptionProfile>.....	288
10.2.16.3	Update <m2mServiceSubscriptionProfile>.....	288
10.2.16.4	Delete <m2mServiceSubscriptionProfile>.....	289
10.2.17	<serviceSubscribedNode> Resource Procedures.....	289
10.2.17.1	Create <serviceSubscribedNode>	289
10.2.17.2	Retrieve <serviceSubscribedNode>	290
10.2.17.3	Update <serviceSubscribedNode>	290
10.2.17.4	Delete <serviceSubscribedNode>	290
10.2.18	Resource Announcement Procedures	291
10.2.18.1	Procedure for AE and CSE to initiate Creation of an Announced Resource	291
10.2.18.2	Procedure at AE or CSE to Retrieve information from an Announced Resource	292
10.2.18.3	Procedure for AE and CSE to initiate Deletion of an Announced Resource	294
10.2.18.4	Procedure for original resource Hosting CSE to Create an Announced Resource	295
10.2.18.5	Procedure for original resource Hosting CSE to Delete an Announced Resource	297
10.2.18.6	Procedure for AE and CSE to initiate the Creation of an Announced Attribute.....	297
10.2.18.7	Procedure for AE and CSE to initiate the Deletion of an Announced Attribute.....	298
10.2.18.8	Procedure for original resource Hosting CSE for Announcing Attributes	299
10.2.18.9	Procedure for original resource Hosting CSE for De-Announcing Attributes.....	300
10.2.18.10	Procedure for original resource Hosting CSE for Updating Attributes	301
10.2.18.11	Notification Procedure targeting an AE Announced Resource	302
10.2.19	<contentInstance> Resource Procedures.....	302
10.2.19.1	Introduction	302
10.2.19.2	<contentInstance> CREATE.....	302
10.2.19.3	<contentInstance> RETRIEVE	303
10.2.19.4	<contentInstance> UPDATE.....	303
10.2.19.5	<contentInstance> DELETE	303
10.2.20	<request> Resource Procedures	303
10.2.20.1	Create <request>	303
10.2.20.2	Retrieve <request>	306
10.2.20.3	Update <request>	306
10.2.20.4	Delete <request>	306
10.2.21	<accessControlPolicy> Resource Procedures	307
10.2.21.1	Create <accessControlPolicy>	307
10.2.21.2	Retrieve <accessControlPolicy>	307
10.2.21.3	Update <accessControlPolicy>	308
10.2.21.4	Delete <accessControlPolicy>	308
10.2.22	<latest> Resource Procedures	308
10.2.22.0	Overview	308
10.2.22.1	Retrieve <latest>	308
10.2.22.2	Delete <latest>.....	308
10.2.23	<oldest> Resource Procedure	309
10.2.23.0	Overview	309
10.2.23.1	Retrieve <oldest>.....	309
10.2.23.2	Delete <oldest>.....	309
10.2.24	<serviceSubscribedAppRule> Resource Procedures	309
10.2.24.1	Create <serviceSubscribedAppRule>.....	309
10.2.24.2	Retrieve <serviceSubscribedAppRule>.....	310
10.2.24.3	Update <serviceSubscribedAppRule>.....	310
10.2.24.4	Delete <serviceSubscribedAppRule>.....	310
10.2.25	<notificationTargetSelfReference> Resource Procedures	311
10.2.25.0	Overview	311
10.2.25.1	Delete <notificationTargetSelfReference>	311
10.2.26	<notificationTargetMgmtPolicyRef> Resource Procedures	311
10.2.26.1	Create <notificationTargetMgmtPolicyRef>.....	311
10.2.26.2	Retrieve <notificationTargetMgmtPolicyRef>	311
10.2.26.3	Update <notificationTargetMgmtPolicyRef>	312

10.2.26.4	Delete <notificationTargetMgmtPolicyRef>.....	312
10.2.27	<notificationTargetPolicy> Resource Procedures.....	312
10.2.27.1	Create <notificationTargetPolicy>	312
10.2.27.2	Retrieve <notificationTargetPolicy>	313
10.2.27.3	Update <notificationTargetPolicy>	313
10.2.27.4	Delete <notificationTargetPolicy>	313
10.2.28	<policyDeletionRules> Resource Procedures	313
10.2.28.1	Create <policyDeletionRules>	313
10.2.28.2	Retrieve <policyDeletionRules>	314
10.2.28.3	Update <policyDeletionRules>	314
10.2.28.4	Delete <policyDeletionRules>	315
10.2.29	<flexContainer> Resource Procedures.....	315
10.2.29.1	Create <flexContainer>	315
10.2.29.2	Retrieve <flexContainer>	316
10.2.29.3	Update <flexContainer>	316
10.2.29.4	Delete <flexContainer>	316
10.2.30	<timeSeries> Resource Procedures	317
10.2.30.1	Create <timeSeries>.....	317
10.2.30.2	Retrieve <timeSeries>	317
10.2.30.3	Update <timeSeries>	317
10.2.30.4	Delete <timeSeries>.....	318
10.2.31	<timeSeriesInstance> Resource Procedures.....	318
10.2.31.1	Create <timeSeriesInstance>	318
10.2.31.2	Retrieve <timeSeriesInstance>	319
10.2.31.3	Update <timeSeriesInstance>	319
10.2.31.4	Delete <timeSeriesInstance>	319
10.2.32	<semanticDescriptor> Resource Procedures	320
10.2.32.1	Create <semanticDescriptor>.....	320
10.2.32.2	Retrieve <semanticDescriptor>.....	320
10.2.32.3	Update <semanticDescriptor>.....	320
10.2.32.4	Delete <semanticDescriptor>.....	321
10.2.33	<role> Resource Procedures	321
10.2.33.1	Create <role>.....	321
10.2.33.2	Retrieve <role>.....	322
10.2.33.3	Update <role>.....	322
10.2.33.4	Delete <role>.....	323
10.2.34	<token> Resource Procedures	323
10.2.34.1	Create <token>	323
10.2.34.2	Retrieve <token>	324
10.2.34.3	Update <token>	324
10.2.34.4	Delete <token>	324
10.2.35	Semantic Discovery Procedures.....	325
10.2.35.1	Introduction	325
10.2.35.2	Discovering and establishing the logical tree in the semantic discovery scope without the use of <semanticFanOutPoint>	325
10.2.35.2.0	Overview.....	325
10.2.35.2.1	Annotation-based method	325
10.2.35.2.2	Resource link-based method	326
10.2.36	Void.....	326
10.2.37	<trafficPattern> Resource Procedures	326
10.2.37.1	Create <trafficPattern>	326
10.2.37.2	Retrieve <trafficPattern>	327
10.2.37.3	Update <trafficPattern>	328
10.2.37.4	Delete <trafficPattern>	328
10.2.38	<dynamicAuthorizationConsultation> Resource Procedures	329
10.2.38.1	Create <dynamicAuthorizationConsultation>	329
10.2.38.2	Retrieve <dynamicAuthorizationConsultation>	329
10.2.38.3	Update <dynamicAuthorizationConsultation>	329
10.2.38.4	Delete <dynamicAuthorizationConsultation>	330
10.2.39	Procedure for Time Series Data Detecting and Reporting	330
10.2.40	<schedule> Resource Procedures	331
10.2.40.1	Create <schedule>	331

10.2.40.2	Retrieve <schedule>	332
10.2.40.3	Update <schedule>	332
10.2.40.4	Delete <schedule>	332
10.3	Notification procedures.....	333
10.3.1	Overview	333
11	Trust Enabling Architecture	333
11.0	Overview	333
11.1	Enrolling M2M Nodes and M2M Applications for oneM2M Services	334
11.2	M2M Initial Provisioning Procedures.....	334
11.2.1	M2M Node Enrolment and Service Provisioning	334
11.2.2	M2M Application Enrolment	335
11.3	M2M Operational Security Procedures.....	335
11.3.0	Overview	335
11.3.1	Identification of CSE and AE.....	336
11.3.2	Authentication and Security Association of CSE and AE.....	337
11.3.3	Void.....	337
11.3.4	M2M Authorization Procedure	337
11.4	Functional Architecture Specifications for End-to-End Security Procedures	339
11.4.1	Functional Architecture Specifications for End-to-End Security of Data (ESData)	339
11.4.2	Functional Architecture Specifications for End-to-End Security of Primitives (ESPrim)	339
11.4.3	Functional Architecture Specifications for Direct End-to-End Security Certificate-based Key Establishment (ESCertKE).....	345
11.5	Functional Architecture Specifications for Dynamic Authorization.....	347
11.5.1	Dynamic Authorization Reference Model.....	347
11.5.2	Direct Dynamic Authorization	348
11.5.3	Indirect Dynamic Authorization.....	350
12	Information Recording	353
12.1	M2M Infrastructure Node (IN) Information Recording.....	353
12.1.0	Overview	353
12.1.1	Information Recording Triggers.....	353
12.1.2	M2M Recorded Information Elements.....	353
12.1.2.1	Unit of Recording	353
12.1.2.2	Information Elements within an M2M Event Record.....	353
12.1.3	Identities Associations in Support of Recorded Information	355
12.2	Offline Charging	355
12.2.1	Architecture.....	355
12.2.2	Filtering of Recorded Information for Offline Charging.....	356
12.2.3	Examples of Charging Scenarios	356
12.2.3.0	Overview	356
12.2.3.1	Example Charging Scenario 1 - Data Storage Resource Consumption	357
12.2.3.2	Example Charging Scenario 2 - Data transfer	357
12.2.3.3	Example Charging Scenario 3 - Connectivity	357
12.2.4	Definition of Charging Information	357
12.2.4.0	Overview	357
12.2.4.1	Triggers for Charging Information	357
12.2.4.2	Charging Messages over Mch Reference Point.....	357
12.2.4.3	Structure of the Accounting Message Formats.....	357
12.2.4.3.1	Accounting-Request Message.....	357
12.2.4.3.2	Accounting-Answer Message	358
Annex A (informative):	Mapping of Requirements with CSFs.....	359
Annex B (informative):	oneM2M System and 3GPP MTC Underlying Network Interworking ..	362
B.1	3GPP MTC Underlying Network Introduction	362
B.2	3GPP MTC Functionality	362
B.2.1	3GPP Release-11 MTC Functionality.....	362
B.2.2	3GPP Release-13 MTC Interworking	364
B.2.2.1	General overview of 3GPP Release-13 MTC Interworking.....	364
B.2.2.2	3GPP Release-13 MTC feature for Configuration of Device Communication Patterns	367

B.3	ASN/MN-CSE initiated connectivity establishment	369
B.3.0	Overview	369
B.3.1	Use of DHCP and DNS	369
B.3.2	Pre-configuration	369
B.4	Serving IN-CSE initiated connectivity establishment	369
B.5	Connectivity between oneM2M Service Layer and 3GPP Underlying Network	370
B.6	Connectivity Establishment Procedures	370
B.6.1	General	370
B.6.1.0	Overview	370
B.6.1.1	ASN/MN-CSE Initiated Connectivity Establishment Procedure	371
B.6.1.2	IN-CSE initiated connectivity establishment procedure over Tsp	372
Annex C (informative):	Interworking between oneM2M System and 3GPP2 Underlying Networks	375
C.1	General Concepts	375
C.2	M2M Communication Models	375
C.3	3GPP2 Architectural Reference Model for M2M	377
C.4	Communication between oneM2M Service Layer and 3GPP2 Underlying Network	377
C.5	Information Flows	378
C.5.0	Overview	378
C.5.1	Tsp Interface Call Flow	379
C.5.2	Point to Point Device Triggering	380
C.5.3	Broadcast Device Triggering	380
Annex D (normative):	<mgmtObj> Resource Instances Description	381
D.1	oneM2M Management Functions	381
D.2	Resource <i>firmware</i>	381
D.3	Resource <i>software</i>	383
D.4	Resource <i>memory</i>	386
D.5	Resource <i>areaNwkInfo</i>	387
D.6	Resource <i>areaNwkDeviceInfo</i>	389
D.7	Resource <i>battery</i>	391
D.8	Resource <i>deviceInfo</i>	393
D.9	Resource <i>deviceCapability</i>	395
D.10	Resource <i>reboot</i>	397
D.11	Resource <i>eventLog</i>	399
D.12	Resource <i>cmdhPolicy</i>	400
D.12.0	Overview	400
D.12.1	Resource <i>activeCmdhPolicy</i>	402
D.12.2	Resource <i>cmdhDefaults</i>	403
D.12.3	Resource <i>cmdhDefEcValue</i>	404
D.12.4	Resource <i>cmdhEcDefParamValues</i>	407
D.12.5	Resource <i>cmdhLimits</i>	409
D.12.6	Resource <i>cmdhNetworkAccessRules</i>	411
D.12.7	Resource <i>cmdhNwAccessRule</i>	413
D.12.8	Resource <i>cmdhBuffer</i>	416
Annex E (informative):	CSE Minimum Provisioning	419

Annex F (informative):	Interworking/Integration of non-oneM2M solutions and protocols	420
F.1	Introduction	420
F.2	Interworking with non-oneM2M solutions through specialized interworking applications	420
F.3	Interworking versus integration of non-oneM2M solutions.....	423
F.4	Entity-relation representation of non-IP based M2M Area Network.....	423
F.4.0	Overview	423
F.4.1	Responsibilities of Interworking Proxy Application Entity (IPE)	424
Annex G:	Void	425
Annex H (informative):	Object Identifier Based M2M Device Identifier	426
H.1	Overview of Object Identifier	426
H.2	OID Based M2M Device Identifier.....	426
H.2.0	Overview	426
H.2.1	M2M Device Indication ID - (higher arc).....	427
H.2.2	Manufacturer ID - (x)	427
H.2.3	Model ID - (y).....	427
H.2.4	Serial Number ID - (z).....	427
H.2.5	Expanded ID - (a)	427
H.3	Example of M2M device ID based on OID	428
Annex I (informative):	Resource addressing examples	429
I.1	Example resource tree	429
I.2	Valid resource IDs.....	430
Annex J (informative):	Bibliography.....	434
Annex K (normative):	Syntaxes for content based discovery of <contentInstance>.....	435
K.1	Introduction.....	435
K.2	'jsonpath' query syntax	435
History	436

1 Scope

The present document describes the end-to-end oneM2M functional architecture, including the description of the functional entities and associated reference points.

oneM2M functional architecture focuses on the Service Layer aspects and takes Underlying Network-independent view of the end-to-end services. The Underlying Network is used for the transport of data and potentially for other services.

2 References

2.1 Normative references

References are either specific (identified by date of publication and/or edition number or version number) or non-specific. For specific references, only the cited version applies. For non-specific references, the latest version of the referenced document (including any amendments) applies.

The following referenced documents are necessary for the application of the present document.

- [1] oneM2M TS-0011: "Common Terminology".
- [2] oneM2M TS-0003: "Security solutions".
- [3] oneM2M TS-0004: "Service Layer Core Protocol Specification".
- [4] W3C Recommendation 25 February 2014: "RDF 1.1 Concepts and Abstract Syntax".

NOTE: Available at <http://www.w3.org/TR/rdf11-concepts/>.

- [5] W3C Recommendation 21 March 2013: "SPARQL 1.1 Query Language".

NOTE: Available at <http://www.w3.org/TR/sparql11-query/>.

- [6] oneM2M TS-0012: "Base Ontology".
- [7] oneM2M TS-0021: "oneM2M and AllJoyn[®] Interworking".
- [8] oneM2M TS-0023: "Home Appliances Information Model and Mapping".
- [9] oneM2M TS-0022: "Field Device Configuration".
- [10] oneM2M TS-0032: "MAF and MEF Interface Specification".

2.2 Informative references

References are either specific (identified by date of publication and/or edition number or version number) or non-specific. For specific references, only the cited version applies. For non-specific references, the latest version of the referenced document (including any amendments) applies.

The following referenced documents are not necessary for the application of the present document but they assist the user with regard to a particular subject area.

- [i.1] oneM2M TS-0002: "Requirements".
- [i.2] Broadband Forum TR-069: "CPE WAN Management Protocol Issue": 1 Amendment 5, November 2013.
- [i.3] OMA-DM: "OMA Device Management Protocol", Version 1.3, Open Mobile Alliance.
- [i.4] LWM2M: "OMA LightweightM2M", Version 1.0, Open Mobile Alliance.
- [i.5] OMA-TS-MLP-V3-4-20130226-C: "Mobile Location Protocol", Version 3.4.

- [i.6] OMA-TS-REST-NetAPI_TerminalLocation-V1_0-20130924-A: "RESTful Network API for Terminal Location", Version 1.0.
 - [i.7] IETF RFC 1035: "Domain names - Implementation and specification".
 - [i.8] IETF RFC 3588: "Diameter Base Protocol".
 - [i.9] IETF RFC 3596: "DNS Extensions to Support IP Version 6".
 - [i.10] IETF RFC 3986: "Uniform Resource Identifier (URI): General Syntax".
 - [i.11] IETF RFC 4006: "Diameter Credit-Control Application".
 - [i.12] IETF RFC 6895: "Domain Name System (DNS) IANA Considerations".
 - [i.13] GSMA-IR.67: "DNS/ENU Guidelines for Service Providers & GRX/IPX Providers".
 - [i.14] 3GPP TS 23.682: "Architecture enhancements to facilitate communications with packet data networks and applications (Release 13)".
 - [i.15] 3GPP TS 32.240: "Telecommunication management; Charging management; Charging architecture and principles".
 - [i.16] 3GPP TS 32.299: "Telecommunication management; Charging management; Diameter charging applications".
 - [i.17] 3GPP2 .S0068: "Network Enhancements for Machine to Machine (M2M)".
 - [i.18] JNI 6.0 API Specification: "Java Native Interface 6.0 Specification".
 - [i.19] 3GPP TS 23.401: "General Packet Radio Service (GPRS) enhancements for Evolved Universal Terrestrial Radio Access Network (E-UTRAN) access".
 - [i.20] 3GPP TS 23.402: "Architecture enhancements for non-3GPP accesses".
 - [i.21] 3GPP TS 23.060: "General Packet Radio Service (GPRS); Service description; Stage 2".
 - [i.22] 3GPP TS 22.368: "Service requirements for Machine Type Communications (MTC); Stage 1".
 - [i.23] 3GPP TS 23.003: "Numbering, addressing and identification".
 - [i.24] Recommendation ITU-T X.660 | ISO/IEC 9834-1: "Information technology - Procedures for the operation of object identifier registration authorities: General procedures and top arcs of the international object identifier tree".
 - [i.25] oneM2M TR-0008: "Analysis of Security Solutions for oneM2M System".
 - [i.26] IETF RFC 4122: "A Universally Unique Identifier (UUID) URN Namespace".
 - [i.27] oneM2M Drafting Rules.
- NOTE: Available at <http://www.onem2m.org/images/files/oneM2M-Drafting-Rules.pdf>.
- [i.28] oneM2M TR-0007: "Study of Abstraction and Semantics Enablement".
 - [i.29] 3GPP TS 22.101: "Service aspects; Service principles (Release 13)".
 - [i.30] 3GPP TS 22.115: "Service aspects; Charging and billing (Release 13)".
 - [i.31] 3GPP TS 29.336: "Home Subscriber Server (HSS) diameter interfaces for interworking with packet data networks and applications (Release 13)".
 - [i.32] OMA-TS-REST-NetAPI-CommunicationPatterns-V1-0: "RESTful Network API for Communication Patterns", Version 1.0, Open Mobile Alliance.

3 Definitions and abbreviations

3.1 Definitions

For the purposes of the present document, the terms and definitions given in oneM2M TS-0011 [1] and the following apply:

NOTE: A term defined in the present document takes precedence over the definition of the same term, if any, in oneM2M TS-0011 [1].

access control attributes: set of parameters of the Originator, target resource, and environment against which there could be rules evaluated to control access

NOTE: An example of Access Control Attributes of Originator is a role. Examples of Access Control Attributes of Environment are time, day and IP address. An example of Access Control Attributes of targeted resource is creation time.

access decision: authorization reached when an entity's Privileges, as well as other Access Control Attributes, are evaluated

application layer: comprises oneM2M Applications and related business and operational logic

attribute: stores information pertaining to the resource

NOTE: An attribute has a name and a value. Only one attribute with a given name can belong to a given resource. For an attribute defined as having "multiplicity" greater than 1, the value of that attribute is a composite value, i.e. a list of different values.

child resource: sub-resource of another resource that is its parent resource

NOTE: The parent resource contains references to the child resources(s).

common services layer: consists of oneM2M service functions that enable oneM2M Applications (e.g. management, discovery and policy enforcement)

common services function (CSF): informative architectural construct which conceptually groups together a number of sub-functions

NOTE: Those sub-functions are implemented as normative resources and procedures. A set of CSFs is contained in the CSE.

content based discovery: is the discovery operation for <contentInstance> resources which is matched with the given condition regarding *content* attribute of <contentInstance> resource under specific <container>

NOTE: Content based discovery is based on knowledge about data structure of M2M data stored at <container>.

execution environment: logical entity that represents an environment capable of running software modules

hosting CSE: CSE where the addressed resource is hosted

M2M service provider domain: is the part of the M2M System that is associated with a specific M2M Service Provider

managed entity: may be either an M2M Device, M2M Gateway, or a device in the M2M Area Network or the M2M Application Layer or M2M Service Layer software components

management proxy: entity within the Device Management Architecture, in conjunction with the Management Client, that acts as an intermediary between the Management Server and the Proxy Management Client

network services layer: provides transport, connectivity and service functions

node: logical entity that is identifiable in the M2M System

non-oneM2M Node: node that does not contain oneM2M Entities

notifier: hosting CSE that initiates notifications to Notification Targets in the subscription/notification framework or in the non-blocking asynchronous scheme

notification target: AE or CSE that receives notifications from the Notifier

NULL: empty string

originator: in case of a request traversing a single reference point, the Originator is the AE/CSE that sends the request

NOTE: In case of a request that traverses multiple reference points, the Originator is the AE/CSE that sends the first request in the sequence.

proxy management client: entity within the Device Management Architecture that provides local management capabilities to a device in an M2M Area Network

receiver: entity that receives the Request

NOTE: A Receiver can be a CSE or can be an AE when notification is requested.

receiver CSE: any CSE that receives a request

registree: AE or CSE that registers with another CSE

registrar CSE: CSE is the CSE where an Application or another CSE has registered

resource: uniquely addressable entity in oneM2M architecture

NOTE: A resource is transferred and manipulated using CRUD operations. A resource can contain child resource(s) and attribute(s), which are also uniquely addressable.

role: collection of permissions that can be statically or dynamically granted to an entity

service charging and accounting: set of functionalities within the M2M Service Layer that enable configuration of information collection and charging policies, collection of Charging Records based on the policies, and correlation of Charging Records to users of M2M common services

service charging record: formatted collection of information about a chargeable operation

service layer offline charging: mechanism where charging information does not affect, in real-time, the service rendered

service layer online charging: mechanism where charging information can affect, in real-time, the service rendered, including real time credit control

software package: is an entity that can be deployed on the Execution Environment

NOTE: It can consist of entities such as software modules, configuration files, or other entities.

structured data: is data that either has a structure according to a specified Information Model or is otherwise organized in a defined manner

transit CSE: is any receiver CSE that is not a Hosting CSE

3.2 Abbreviations

For the purposes of the present document, the following abbreviations apply:

2G	Second Generation
3GPP	3 rd Generation Partnership Project
3GPP2	3 rd Generation Partnership Project 2
A/AAAA	IPv4/IPv6 DNS records that are used to map hostnames to an IP address
AAA	Authentication, Authorization, Accounting
AAAA	Authentication, Authorization, Accounting and Auditing
ABT	Additional back-off time
ACA	Accounting Answer

ACK	Acknowledgement
ACP	Access Control Policy
ACR	Accounting Request
ADN	Application Dedicated Node
ADN-AE	AE which resides in the Application Dedicated Node
AE	Application Entity
AE/CSE	Application Entity/Common Services Entity
AE-ID	Application Entity Identifier
AID	Addressing and Identification
Annnc	Announced
API	Application Program Interface
App-ID	Application Identifier
AS	Application Server
ASM CSF	Application and Service Layer Management CSF
ASM	Application and Service Layer Management
ASN	Application Service Node
ASN/MN	Application Service Node/Middle Node
ASN-AE	Application Entity that is registered with the CSE at Application Service Node
ASN-CSE	CSE which resides in the Application Service Node
AVP	Attribute-Value Pair
BBF	BroadBand Forum
CDR	Charging Data Record
CF	Configuration Function
CHF	Charging Function
CM	Conditional Mandatory
CMDH	Communication Management and Delivery Handling
COSEM	Companion Specification for Energy Metering
CP	Communication Patterns
CRUD	Create Retrieve Update Delete
CRUDN	Create Retrieve Update Delete Notify
CSE	Common Services Entity
CSE-ID	Common Service Entity Identifier
CSE-PoA	CSE Point of Access
CSF	Common Services Function
DAS	Dynamic Authorization System
DCF	Device Configuration Function
DDMF	Device Diagnostics and Monitoring Function
DFMF	Device Firmware Management Function
DHCP	Dynamic Host Configuration Protocol
DIS CSF	Discovery CSF
DIS	Discovery
DM	Device Management
DMG CSF	Device Management CSF
DMG	Device Management
DMR	Data Management and Repository
DNS	Domain Name Server
DTMF	Device Topology Management Function
ESN	Electronic Serial Number
FFS	For Further Specification
FQDN	Fully Qualified Domain Name
GMG CSF	Group Management CSF
GMG	Group Management
GPRS	General Packet Radio Service
GPS	Global Positioning System
GSMA	GSM Association (Global System for Mobile Communications Association)
GW	Gateway
HA/LMA	Home Agent/Local Mobility Agent
HAAA	Home AAA
HAIM	Home Appliance Information Model
HLR	Home Location Register
HSS	Home Subscriber Server
HTTP	HyperText Transfer Protocol

IBT	Initial back-off time
ID	Identifier
IETF	Internet Engineering Task Force
IMEI	International Mobile Equipment Identity
IMS	IP Multimedia System
IMSI	International Mobile Subscriber Identity
IN	Infrastructure Node
IN-AE	Application Entity that is registered with the CSE in the Infrastructure Node
IN-CSE	CSE which resides in the Infrastructure Node
IN-DMG	Infrastructure Node Device ManaGement
IN-DMG-MA	Infrastructure Node Device ManaGement Management Adapter
IP	Internet Protocol
IPE	Interworking Proxy application Entity
ISO	International Organization for Standardization
ITU-T	ITU Telecommunication Standardization Sector
IWF	InterWorking Function
JNI	Java Native Interface
JSON	JavaScript Object Notation
LOC CSF	Location CSF
LOC	Location
LWM2M	Lightweight M2M
M2M	Machine to Machine
M2M-IWF	M2M InterWorking Function
M2M-Sub-ID	M2M service Subscription Identifier
MA	Mandatory Announced
MAF	M2M Authentication Function
MBMS	Multimedia Broadcast Multicast Service
MBT	Maximum back-off time
Mca	Reference Point for M2M Communication with AE
Mcc	Reference Point for M2M Communication with CSE
Mcc'	Reference Point for M2M Communication with CSE of different M2M Service Provider
Mch	Reference Point for M2M Communication with external charging server
Mcn	Reference Point for M2M Communication with NSE
MEF	M2M Enrolment functions
MEID	Mobile Equipment Identifier
MIP	Mobile IP
MN	Middle Node
MN-AE	Application Entity that is registered with the CSE in Middle Node
MN-CSE	CSE which resides in the Middle Node
MQTT	Message Queuing Telemetry Transport
MSISDN	Mobile Subscriber International Subscriber Directory Number
MTC	Machine Type Communications
MTE	M2M Trust Enabler
NA	Not Announced
NAT	Network Address Translation
NIDD	Non-IP Data Delivery
NoDN	Non-oneM2M Node
NP	Not Present
NSE	Network Service Entity
NSSE CSF	Network Service Exposure, Service Execution and Triggering CSF
NSSE	Network Service Exposure, Service Execution and Triggering
NWA	Network Action
OA	Optional Announced
OID	Object Identifier
OMA	Open Mobile Alliance
OMA-DM	Open Mobile Alliance Device Management
OWL	Web Ontology Language
PDP	Packet Data Protocol
PDSN	Packet Data Serving Node
PMIP	Proxy Mobile IP
PoA	Point of Access
PPP	Point to Point Protocol

QoS	Qualify of Service
RAM	Random Access Memory
RBAC	Role Based Access Control
RBT	Random back-off time
RDF	Resource Description Framework
REG CSF	Registration CSF
REG	Registration
RFC	Request for Comments
RO	Read Only
RPC	Remote Procedure Calls
RW	Read Write
SCA CSF	Service Charging and Accounting CSF
SCA	Service Charging and Accounting
SCEF	Service Capability Exposure Function
SCS	Services Capability Server
SDO	Standards Developing Organization
SEA	Security Association Endpoint
SEC CSF	Security CSF
SEC	Security
SIP	Session Initiation Protocol
SLA	Service Level Agreement
SMF	Software Monitoring Function
SMS	Short Messaging Service
SP	Service Provider
SPARQL	SPARQL Protocol and RDF Query Language
SP-ID	Service Provider Identifier
SSM	Service Session Management
SUB CSF	Subscription and Notification CSF
SUB	Subscription and Notification
SWT	SpreadingWaitTime
TCP	Transport Control Protocol
TLS	Transport Layer Security
TP	Traffic Patterns
TR	Technical Report
TS	Technical Specification
Tsms	Interface between Short Message Entity (SME) and Short Message Service Center (SMS SC)
Tsp	Interface between Service Capability Server (SCS) and Machine Type Communication (MTC)
	InterWorking Function
UE	User Equipment
UL	UpLink
URI	Uniform Resource Identifier
URL	Uniform Resource Locator
URN	Uniform Resource Name
UTRAN	Universal Terrestrial Radio Access Network
UUID	Universally Unique Identifier
WLAN	Wireless Local Area Network
WO	Write Once
XML	Extensible Markup Language
XSD	XML Schema Definition

4 Conventions

The keywords "Shall", "Shall not", "May", "Need not", "Should", "Should not" in the present document are to be interpreted as described in the oneM2M Drafting Rules [i.27].

To improve readability:

- The information elements of oneM2M Request/Response messages will be referred to as parameters. Parameter abbreviations will be written in bold italic.

- The information elements of resources will be referred to as attributes and child resources. Attributes will be written in italics.

5 Architecture Model

5.1 General Concepts

Figure 5.1-1 depicts the oneM2M Layered Model for supporting end-to-end (E2E) M2M Services. This layered model comprises three layers: Application Layer, Common Services Layer and the underlying Network Services Layer.

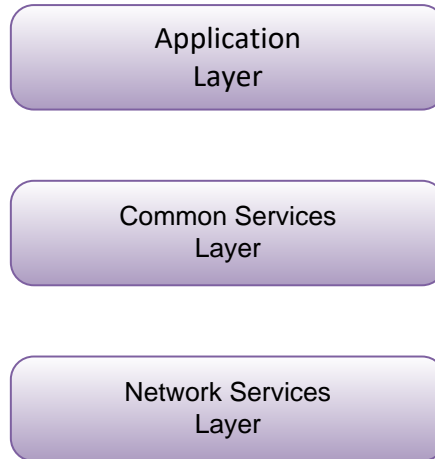

Figure 5.1-1: oneM2M Layered Model

5.2 Architecture Reference Model

5.2.1 Functional Architecture

Figure 5.2.1-1 illustrates the oneM2M functional architecture.

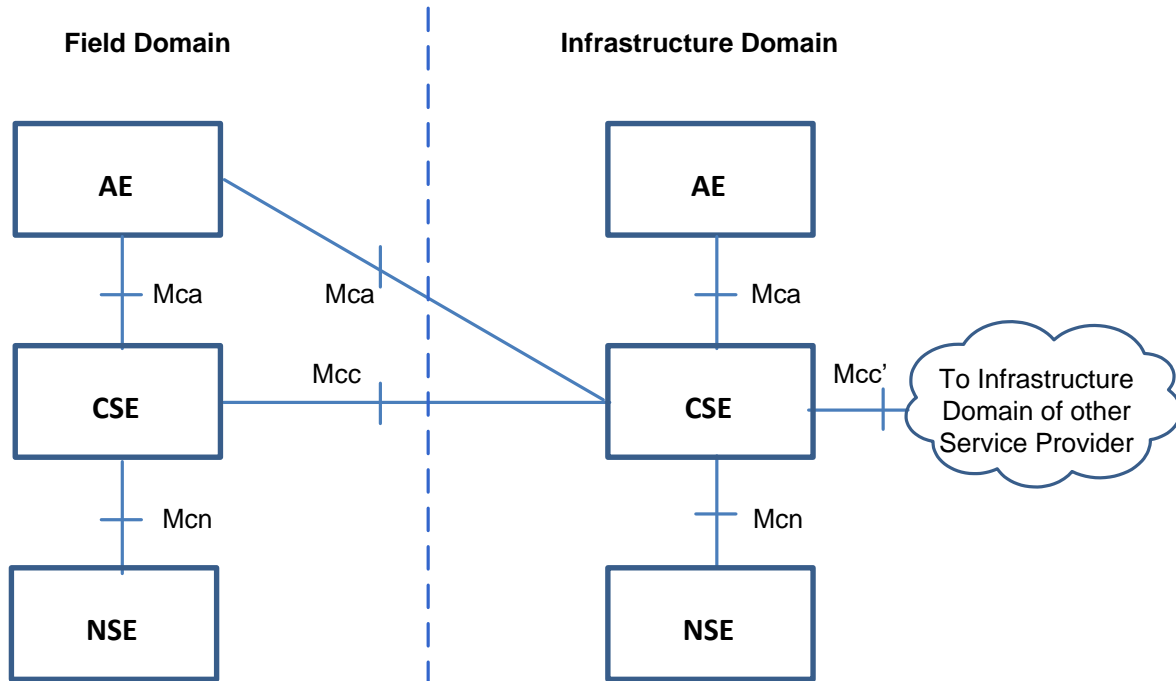

Figure 5.2.1-1: oneM2M Functional Architecture

NOTE 1: Other reference points are specified in other clauses of the present document. See clauses 6.2.4 and 12.2.1.

NOTE 2: The above architecture diagram is a functional diagram. For examples of physical mappings, see clause 6.

The oneM2M functional architecture in figure 5.2.1-1 comprises the following functions:

- 1) **Application Entity (AE):** Application Entity is an entity in the application layer that implements an M2M application service logic. Each application service logic can be resident in a number of M2M nodes and/or more than once on a single M2M node. Each execution instance of an application service logic is termed an "Application Entity" (AE) and is identified with a unique AE-ID (see clause 7.1.2). Examples of the AEs include an instance of a fleet tracking application, a remote blood sugar monitoring application, a power metering application, or a controlling application.
- 2) **Common Services Entity (CSE):** A Common Services Entity represents an instantiation of a set of "common service functions" of the M2M environments. Such service functions are exposed to other entities through the Mca and Mcc reference points. Reference point Mcn is used for accessing underlying Network Service Entities. Each Common Service Entity is identified with a unique CSE-ID (see clause 7.1.4).
 - Examples of service functions offered by CSE include: Data Management, Device Management, M2M Service Subscription Management, and Location Services. Such "sub-functions" offered by a CSE may be logically and informatively conceptualized as Common Services Functions (CSFs). The normative Resources which implement the service functions in a CSE can be mandatory or optional.
- 3) **Underlying Network Services Entity (NSE):** A Network Services Entity provides services from the underlying network to the CSEs. Examples of such services include device management, location services and device triggering. No particular organization of the NSEs is assumed.

NOTE 3: Underlying networks provide data transport services between entities in the oneM2M System. Such data transport services are not included in the NSE.

5.2.2 Reference Points

5.2.2.0 Overview

A reference point consists of one or more interfaces of any kind. The following reference points are supported by the Common Services Entity (CSE). The "Mc(-)" nomenclature is based on the mnemonic "M2M communications".

NOTE: Information exchange between two M2M Entities assumes the usage of the transport and connectivity services of the Underlying Network, therefore, they are not explicitly defined as services provided by the underlying Network Service Entity(s) in the scope of the present document.

5.2.2.1 Mca Reference Point

Communication flows between an Application Entity (AE) and a Common Services Entity (CSE) cross the Mca reference point. These flows enable the AE to use the services supported by the CSE, and for the CSE to communicate with the AE.

NOTE: The AE and the CSE may or may not be co-located within the same physical entity.

5.2.2.2 Mcc Reference Point

Communication flows between two Common Services Entities (CSEs) cross the Mcc reference point. These flows enable a CSE to use the services supported by another CSE.

5.2.2.3 Mcn Reference Point

Communication flows between a Common Services Entity (CSE) and the Network Services Entity (NSE) cross the Mcn reference point. These flows enable a CSE to use the supported services (other than transport and connectivity services) provided by the NSE.

5.2.2.4 Mcc' Reference Point

Communication flows between two Common Services Entities (CSEs) in Infrastructure Nodes (IN) that are oneM2M compliant and that resides in different M2M SP domains cross the Mcc' reference point. These flows enable a CSE of an IN residing in the Infrastructure Domain of an M2M Service Provider to communicate with a CSE of another IN residing in the Infrastructure Domain of another M2M Service Provider to use its supported services, and vice versa.

Mcc' extends the reachability of services offered over the Mcc reference point, or a subset thereof.

The trigger for these communication flows may be initiated elsewhere in the oneM2M network.

5.2.2.5 Other Reference Points and Interfaces

- See clause 12.2.1 for Mch reference point.
- See clause 6.2.4 for Mc, Mp, Ms and La device management interfaces.
- See clause 11.0 for Mmaf and Mmef reference points.

6 oneM2M Architecture Aspects

6.1 Configurations supported by oneM2M Architecture

The possible configurations of inter-connecting the various entities supported within the oneM2M system are illustrated in figure 6.1-1. The illustration does not constrain the multiplicity of the entities nor require that all relationships shown are present.

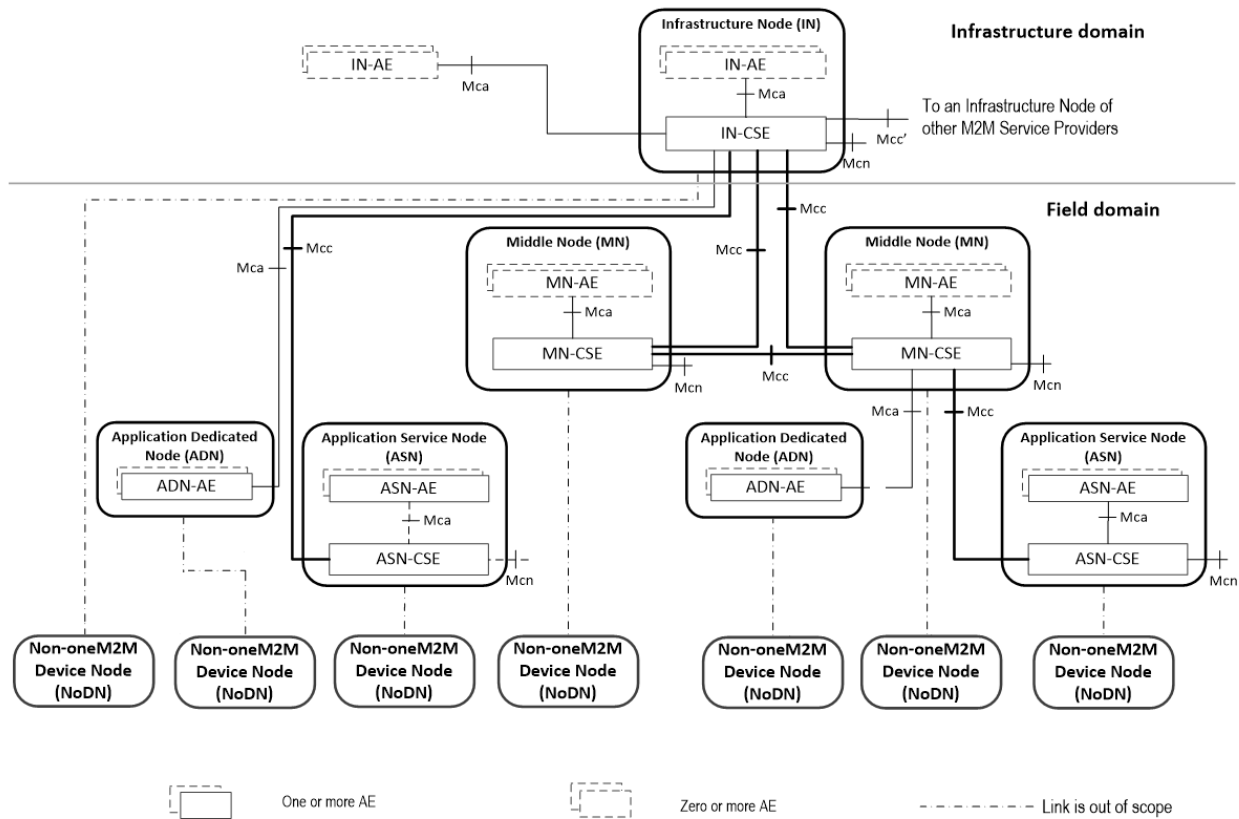

Figure 6.1-1: Configurations supported by oneM2M Architecture

Nodes:

Nodes are logical entities that are individually identifiable in the oneM2M System. Nodes are either CSE-Capable or Non-CSE-Capable:

- A CSE-Capable Node is a logical entity that contains one oneM2M CSE and contains zero or more oneM2M AEs. The ASN, IN and MN are examples of CSE-Capable Nodes.
- A Non-CSE-Capable Node is a logical entity that does not contain a oneM2M CSE and contains zero or more oneM2M AEs. The ADN and Non-oneM2M Node are examples of Non-CSE-Capable Nodes.

CSEs resident in different Nodes can be different and are dependent on the services supported by the CSE and the characteristics (e.g. different memory, firmware) of the physical entity that contains the CSE's Node.

Description of Node types:

The oneM2M architecture enables the following types of Nodes. As logical objects, such Nodes may or may not be mapped to physical objects.

Application Service Node (ASN):

An ASN is a Node that contains one CSE and contains at least one Application Entity (AE). There may be zero or more ASNs in the Field Domain of the oneM2M System.

The CSE in an ASN communicates over the Mcc reference point with one CSE residing in a MN or in an IN.

An AE in an ASN communicates over the Mca reference point with the CSE residing in the same ASN.

An ASN communicates over Mcn with NSEs.

Example of physical mapping: an ASN could reside in an M2M Device.

Application Dedicated Node (ADN):

An ADN is a Node that contains at least one AE and does not contain a CSE. There may be zero or more ADNs in the Field Domain of the oneM2M System.

An AE in the ADN communicates over the Mca reference point with a CSE residing in a MN or in an IN.

Example of physical mapping: an Application Dedicated Node could reside in a constrained M2M Device.

Middle Node (MN):

A MN is a Node that contains one CSE and contains zero or more AEs. There may be zero or more MNs in the Field Domain of the oneM2M System.

The CSE in a MN communicates over the Mcc reference point with one CSE residing in a MN or in an IN and with one or more other CSEs residing in MNs or in ASNs.

In addition, the CSE in the MN can communicate over the Mca reference point with AEs residing in the same MN or residing in an ADN.

A CSE in a MN communicates over Mcn with NSEs.

Example of physical mapping: a MN could reside in an M2M Gateway.

Infrastructure Node (IN):

An IN is a Node that contains one CSE and contains zero or more AEs. There is exactly one IN in the Infrastructure Domain per oneM2M Service Provider. A CSE in an IN may contain CSE functions not applicable to other node types.

The CSE in the IN communicates over the Mcc reference point with one or more CSEs residing in MN(s) and/or ASN(s).

The CSE in the IN communicates over the Mca reference point with one or more AEs residing in the same IN or residing in an ADN.

The CSE in the IN communicates over the Mcn reference point with NSEs, and over the Mcc' reference point with CSEs residing in the INs of other M2M Service Providers.

Example of physical mapping: an IN could reside in an M2M Service Infrastructure.

Non-oneM2M Node (NoDN):

A non-oneM2M Node is a Node that does not contain oneM2M Entities (neither AEs nor CSEs). Such Nodes represent devices attached to the oneM2M system for interworking purposes, including management.

A Non-oneM2M Node communicates (as shown by dotted lines in figure 6.1-1) with the oneM2M System according to annex F.

Domain Types:

The Infrastructure Domain of any particular M2M Service Provider contains exactly one Infrastructure Node.

The Field Domain of any particular M2M Service Provider can contain Application Service Nodes, Application Dedicated Nodes, Middle Nodes and Non-oneM2M Nodes.

6.2 Common Services Functions

6.2.0 Overview

This clause describes the services provided by the Common Services Layer in the M2M System. Such services reside within a CSE and are referred to as Common Services Functions (CSFs). The CSFs provide services to the AEs via the Mca reference point and to other CSEs via the Mcc reference point. CSEs interact with the NSE via the Mcn reference point. An instantiation of a CSE in a Node comprises a subset of the CSFs from the CSFs described in the present document.

The CSF descriptions in this clause are provided for the understanding of the oneM2M Architecture functionalities and are informative. The CSFs contained inside the CSE can interact with each other but how these interactions take place are not specified in the present document.

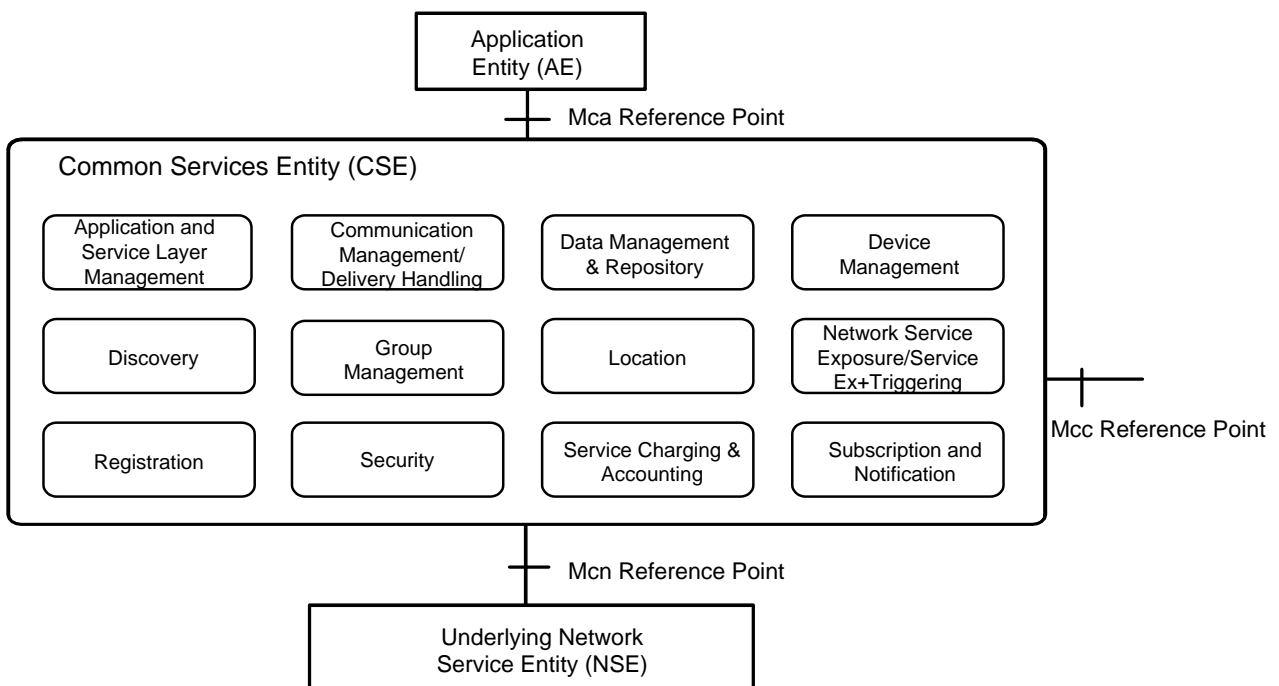

Figure 6.2.0-1: Common Services Functions

6.2.1 Application and Service Layer Management

6.2.1.1 General Concepts

The Application and Service Layer Management (ASM) CSF provides management of the AEs and CSEs on the ADNs, ASNs, MNs and INs. This includes capabilities to configure, troubleshoot and upgrade the functions of the CSE, as well as to upgrade the AEs.

6.2.1.2 Detailed Descriptions

6.2.1.2.0 Overview

The ASM CSF provides management capabilities for CSEs and AEs.

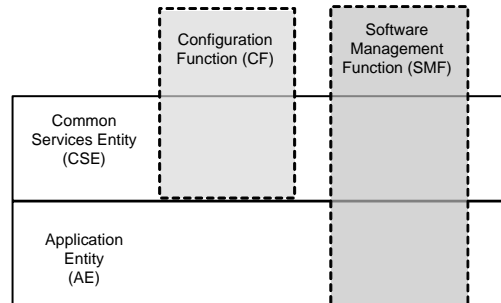

Figure 6.2.1.2.0-1: Management Layers and Function

The ASM CSF utilizes the functions provided by the Device Management (DMG) CSF for interaction with the Management Server.

The management functions include:

- Configuration Function (CF): This function enables the configuration of the capabilities and features of the CSE (e.g. CMDH policies).
- Software Management Function (SMF): This function provides lifecycle management for software components and associated artifacts (e.g. configuration files) for different entities such as CSE and AE.

6.2.1.2.1 Software Management Function

The Software Management Function (SMF) provides the capability to manage software components (e.g. Software Package, Software Module) for AEs and CSEs.

The ASM CSF provides the capability to manage the lifecycle of the Software Packages for a CSE or an AE. AE Software Packages may be deployed on any Node that supports the AE; including those on the MNs, ADNs and ASNs.

The lifecycle of a Software Package consists of states (e.g. Installing, Installed, Updating, Uninstalling and Uninstalled) that transition when an action (e.g. Download, Install, Update and Remove) is applied to the Software Package.

When a Software Package is installed into an execution environment the software component that is capable of executing in the Execution Environment is called a Software Module. The lifecycle of a Software Module consists of states (e.g. Idle, Starting, Active, Stopping) that transition when an action (e.g. Start, Stop) is applied to the Software Module.

6.2.2 Communication Management and Delivery Handling

6.2.2.1 General Concepts

The Communication Management and Delivery Handling (CMDH) CSF provides communications with other CSEs, AEs and NSEs.

The CMDH CSF decides at what time to use which communication connection for delivering communications (e.g. CSE-to-CSE communications) and, when needed and allowed, to buffer communication requests so that they can be forwarded at a later time. This processing in the CMDH CSF is carried out per the provisioned CMDH policies and delivery handling parameters that can be specific to each request for communication.

For communication using the Underlying Network data transport services, the Underlying Network can support the equivalent delivery handling functionality. In such case the CMDH CSF uses the Underlying Network, and it may act as a front end to access the Underlying Network equivalent delivery handling functionality.

6.2.2.2 Detailed Descriptions

The service that AEs or CSEs can request from the CMDH CSF is to transport some data to a specific target (CSE or AE), according to given delivery parameters while staying within the constraints of provisioned communication management and delivery handling policies.

The content of the data provided by the Originator does not influence the CMDH CSF behaviour. Consequently, the CMDH CSF is not aware of the specific operation requested at the target entity, including the parameters passed to the operation at the destination CSF. This means that all attributes intended to be delivered to the destination entity (e.g. which CSF is the destination on the target entity, what that CSF does with the data, etc.) are hidden to the CMDH CSF.

The target entity may be reached either directly or via the CSE(s) of a MN(s).

As part of the delivery request, the CMDH CSF can be provided with acceptable delivery parameters for the Originator (e.g. acceptable expiration time for delivery).

The functions supported by the CMDH CSF are as follows:

- Ability for the M2M Service Provider to derive CMDH policies describing details for the usage of the specific Underlying Network(s). These policies may be based on the M2M Service Subscription associated with Application and Common Service Entities (AEs and CSEs) in the Field Domain and on the agreements on usage of Underlying Network communication resources. CMDH Policies can be provisioned into the respective CSEs in the Field Domain.
- For the delivery of communication, ability to select appropriate communication path to use at any given time in line with provisioned CMDH policies and with CMDH-related parameters set by the Originator of requests, and when needed and allowed, how long to buffer communication requests so that they can be forwarded at a later time. This policy-driven use of communication resources allows an M2M Service Provider to control which Originators of requests are allowed to consume communication resources at certain times.
- For the delivery of communication, ability to detect a disconnection of communication channel. If the communication channel can be established by receiver-side only, it also detects a reconnection of the communication channel.
- For the delivery of communication, ability to be aware of the availability of the Underlying Networks.
- Ability to manage the proper use of buffers for store-and-forward processing through use of CMDH policies.

6.2.3 Data Management and Repository

6.2.3.1 General Concepts

One of the purposes of CSEs is to enable AEs to exchange data with each other.

The Data Management and Repository (DMR) CSF is responsible for providing data storage and mediation functions. It includes the capability of collecting data for the purpose of aggregating large amounts of data, converting this data into a specified format, and storing it for analytics and semantic processing. The data can be either raw data transparently retrieved from an M2M Device, or processed data which is calculated and/or aggregated by M2M entities.

NOTE: Collection of large amounts of data is known as the Big Data Repository and is not part of the present document.

6.2.3.2 Detailed Descriptions

The DMR CSF provides the capability to store data such as Application data, subscriber information, location information, device information, semantic information, communication status, access permission, etc. The data stored by the DMR CSF enables management of the data and provides the foundation of Big Data.

The following are examples of DMR CSF functionalities:

- Ability to store data in an organized fashion so it is discernible. This includes storage of contextual information such as data types, semantic information, time stamps, location, etc., to complement the data stored in order to access and search the data based on a set of parameters. This is part of data semantics capability which is not part of the present document.
- Provides the means to aggregate data received from different entities.
- Ability to grant access to data from remote CSEs and AEs based on defined access control policies, and trigger data processing based on data access.
- Ability to provide the means to perform data analytics on large amount of data to allow service providers to provide value-added services.

6.2.4 Device Management

6.2.4.1 General Concepts

6.2.4.1.0 Overview

The Device Management (DMG) CSF provides management of device capabilities on MNs (e.g. M2M Gateways), ASNs and ADNs (e.g. M2M Devices), as well as devices that reside within an M2M Area Network. Application Entities (AE) can manage the device capabilities on those Nodes by using the services provided by the DMG CSF alleviating the need for the AE to have knowledge of the technology specific protocols or data models. While the AE does not require an understanding of the technology specific protocols or data models, this information is provided to the AE so that an AE can utilize this information for administrative purposes (e.g. diagnostics, troubleshooting).

6.2.4.1.1 Device Management Architecture

In order to manage the CSE and device capabilities of the MNs, ASNs and ADNs, the DMG can utilize existing technology specific protocols (e.g. BBF TR-069 [i.2], OMA-DM [i.3], and LWM2M [i.4]) in addition to management of Management Resources across the Mcc reference point. When the technology specific protocols are used to manage the MN, ASN or ADN, the DMG of the IN translates or adapts the management related requests from other CSEs or from AEs to the technology specific requests of the corresponding technologies.

In order to perform the translation and adaptation functions, the DMG has a functional component termed the Management Adapter (figure 6.2.4.1.1-1). The Management Adapter in the DMG of the IN (IN-DMG-MA) performs the adaptation between the DMG and Management Servers using the **ms** interface; while the Management Adapter in the DMG of the MN (MN-DMG-MA) and ASN (ASN-DMG-MA) performs translation and adaptation between the DMG and the Management Client using the **la** interface. Only one Management Adapter is shown in the DMG although it can interact with Management Server using different technology specific protocols.

The interface between Management Server and Management Client (figure 6.2.4.1.1-1) is the **mc** interface which is subject to the technology specific protocol that is used (e.g. BBF TR-069 [i.2] or LWM2M [i.4]). The **mc** interface is technology dependent and is outside the scope of the present document.

The DMG in the CSE of the MN has the same functionality as the DMG in the CSE of the ASN. In addition, the DMG in the MN can be used to manage devices in the M2M Area Network. In this case, the DMG is deployed with proxy functionality that interacts with the Proxy Management Client using the **mp** interface. The **mp** interface is technology dependent and is outside the scope of the present document.

The Management Server and Management Client can be implemented as an entity external to the Node or they can be implemented as an entity embedded within the Node (figure 6.2.4.1.1-1). The Management Server and the Management Client are located on the boundary of the Node to indicate this situation as well as to depict that an IN can utilize multiple Management Servers from various M2M and Network Service Providers.

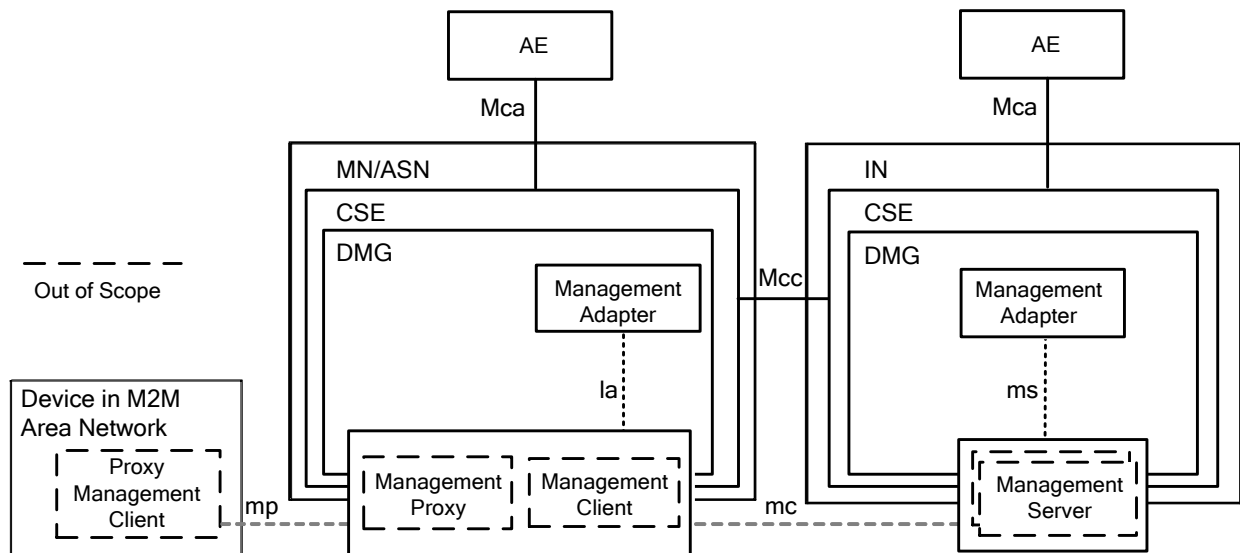

Figure 6.2.4.1.1-1: Device Management Architecture

6.2.4.1.2 Management Server Interaction

6.2.4.1.2.1 Overview

The DMG CSF in the IN has the capability to utilize Management Servers from technology specific protocols (e.g. BBF TR-069 [i.2], OMA DM [i.3], LWM2M [i.4]) to implement the Device Management functions. The IN-DMG-MA communicates with the Management Server using the **ms** interface that is provided by the Management Server. Note that **ms** interface is outside the scope of the present document. The IN-DMG-MA takes the following roles:

- Protocol Translation between DMG and the Management Server:
 - After the DMG receives the requests from the request Originator, the IN-DMG-MA translates the requests from the request Originator to requests with associated identifiers that can be understood by the Management Server. Likewise the IN-DMG-MA translates events from the Management Server and delivers the events to M2M Entities (e.g. AE, CSE) that are subscribed to the event. When the Management Server is embedded within the IN-DMG, the Management Adapter translates the request and accepts events in the protocol understood by the Management Client.
- Interaction with the Management Server:
 - By using **ms** interface, the IN-DMG-MA can communicate with the Management Server. This is for delivering the requests from the request Originator to the Management Server, or receiving information from the Management Server that will be notified to subscribing M2M Entities (e.g. AE, CSE). The communication between the IN-DMG-MA and the Management Server requires an establishment of a session. The establishment of a session between the IN-DMG-MA and Management Server provides security dimensions for Access Control, Authentication, Non-repudiation, Data confidentiality, Communication security, Data integrity and Privacy. The IN-DMG-MA can utilize a policy that defines when a session between the IN-DMG-MA and Management Server is established and torn down.
- Management Server selection:
 - When the IN-DMG-MA communicates with multiple Management Servers that have different level of access control privileges to resources from the Management Server the IN-DMG-MA selects the proper Management Server that has the access control privileges to perform the management requests. The access control policy information for resources from Management Servers may be discovered using the **ms** interface.

- Discovery of technology specific data model objects:
 - When the IN-DMG-MA maintains information (i.e. metadata, values) of the technology specific data model objects managed by a Management Server using the **ms** interface, the IN-DMG-MA will be capable of discovering and keep up to date the technology specific data model object's information that are managed by the IN-DMG and a Management Server.

A Management Server can be located in the Underlying Network using the Mcn reference point as depicted in figure 6.2.4.1.2.1-1 or the Management Server can be located in the M2M Service Layer as depicted in figure 6.2.4.1.2.1-2.

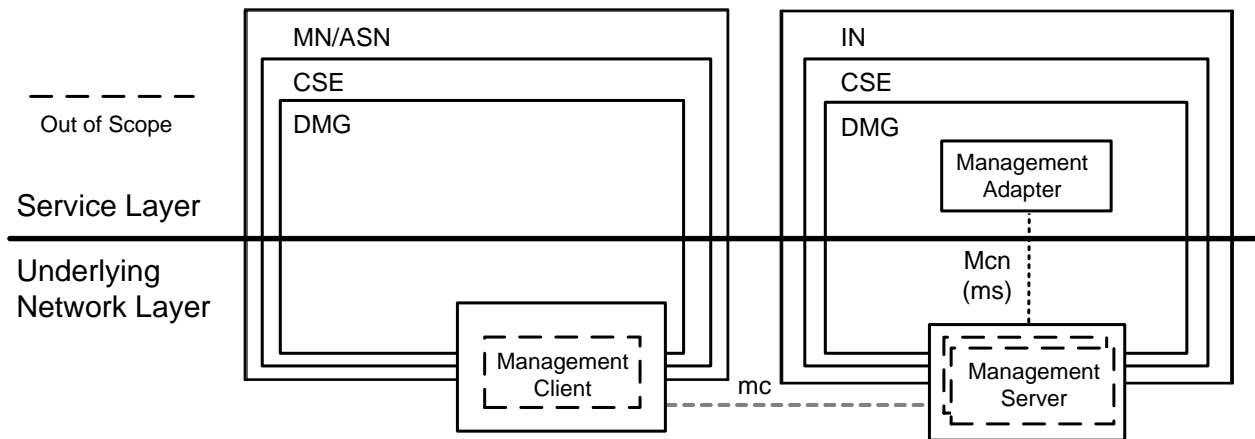

Figure 6.2.4.1.2.1-1: Management Server in Underlying Network

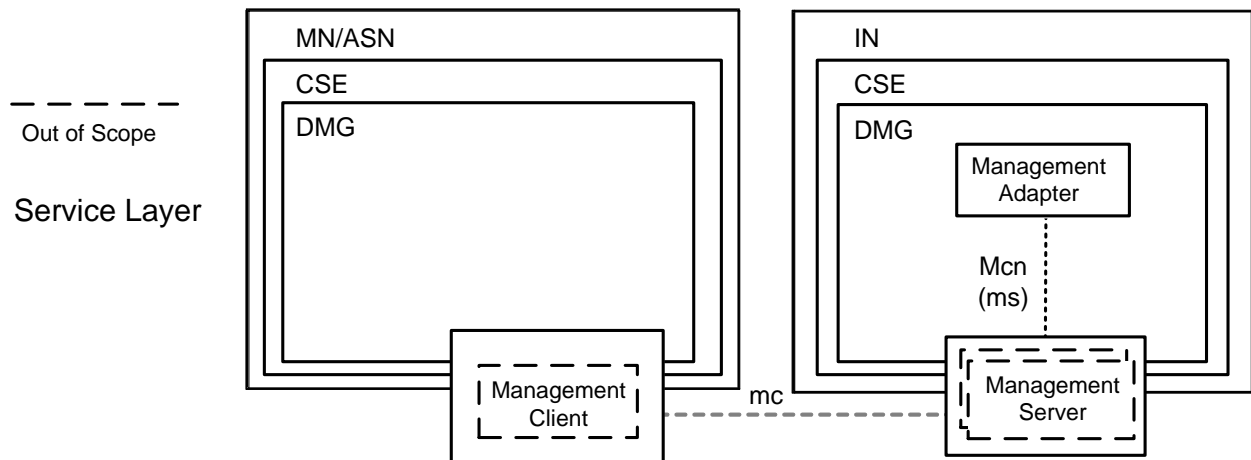

Figure 6.2.4.1.2.1-2: Management Server in M2M Service Layer

The **ms** interface is functionally the same interface regardless if the Management Server resides in the Underlying Network or the Service Layer. However, the access control privileges that the Management Server has for resources from the technology specific protocol can be different depending whether the Management Server resides in the Underlying Network or in the Services Layer. For example in figure 6.2.4.1.2.1-1, the Management Server in the Underlying Network controls access of the exposed resources from the technology specific protocol, while, in the figure 6.2.4.1.2.1-2, the Management Server in the M2M Service Layer controls access to the resources.

6.2.4.1.2.2 Management Server - Access Permissions

When an operation on an M2M Service Layer Resource is performed and if the access to the Resource is granted and the operation for the Resource utilizes a Management Server external to the service layer, the IN-DMG CSF selects one or more among the authenticated Management Servers necessary to access the requested resources. The procedure for the selection of Management Servers is implementation specific and outside the scope of the present document.

The DMG CSF management functions that cause impacts to the Underlying Network utilize access permissions that are delegated from the provider of the network service layer.

6.2.4.1.2.3 Management Server - External management object discovery

An IN-DMG-MA discovers information of the technology specific data model objects managed by a Management Server using the **ms** interface. The discovery of this information includes the:

- M2M devices, devices in the M2M Area Network and M2M Applications to which the Management Server has access.
- The metadata associated with the technology specific data model objects associated the M2M devices, devices in the M2M Area Network and M2M Applications. This metadata includes items such as the supported data/object model.

The IN-DMG-MA is capable of being kept up-to-date of the changes in the M2M Devices, devices in the M2M Area Network and M2M Applications or the metadata of the technology specific data model objects associated with those entities. In addition, the IN-DMG-MA can maintain the value associated technology specific data model objects, associated the M2M devices, devices in the M2M Network and M2M Applications.

6.2.4.1.3 Management Client Interaction

6.2.4.1.3.1 Overview

The DMG CSF in the MN or ASN can use the Management Client from existing management technologies (e.g. BBF TR-069 [i.2], OMA DM [i.3], LWM2M [i.4]) to implement the Device Management functions. The MN-DMG-MA or ASN-DMG-MA communicates with the Management Client using the **la** interface (e.g. DM-7, 8, 9 ClientAPI in OMA DM [i.3]) that is provided by the Management Client. Note that the **la** interface is outside the scope of the present document. The MN-DMG-MA or ASN-DMG-MA takes the following roles:

- Interaction with the Management Client:
 - By using **la** interface, the Management Adapter can communicate with the Management Client to discover the technology specific data model objects supported by the Management Client.
- Mapping between the DMG and Management Client:
 - After the Management Adapter discovers the technology specific data model objects supported by the Management Client; the Management Adapter performs the mapping between the technology specific data model objects to resources. The DMG in the MN or ASN can create those resources in the IN-CSE, and the resources can be used by the IN-AE to manage the device capabilities pertaining to the MN or ASN.

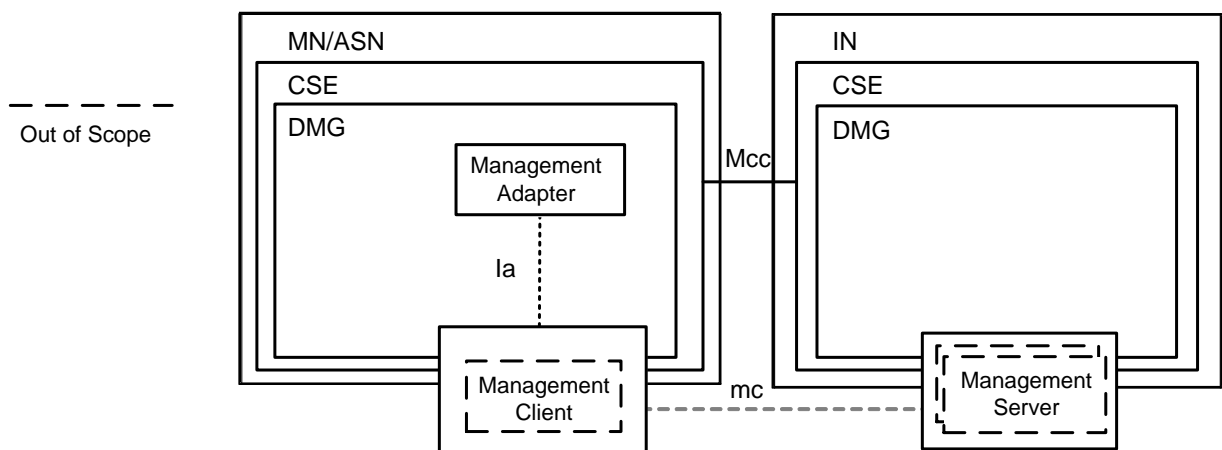

Figure 6.2.4.1.3.1-1: Management Client Interaction using "la" interface

6.2.4.1.4 Device Management Resource Lifecycle

6.2.4.1.4.1 Resource Attributes from Device Management Resources

The lifecycle of a Device Management Resource is implemented using the resource management information defined in clause 9.1 through clause 9.5 and the corresponding procedures to Create, Retrieve, Update and Delete the resources are defined in clause 10. This clause describes additional resource management and procedures for Device Management Resources.

6.2.4.1.4.2 Overview

Clauses 9.1 through 9.5 define resource management information that is applicable to any type of resource, including Device Management Resources. In addition a Device Management Resource also maintains information and relationships that are specific to Device Management Resources. This information is used to:

- Manage technology specific data model objects via a Management Server which requires the information necessary to identify and access the Management Server.
- Invoke the security mechanism of the Management Server in order to authorize access to the technology specific data model objects.

6.2.4.1.4.3 Procedures for Creation, Update and Deletion of Device Management Resources

Clause 10 defines the procedures to Create, Update and Delete resources. These procedures are also applicable to Device Management Resources in addition to the procedures Device Management Resources are Created, Updated or Deleted:

- By administrative means using the Mca reference point.
- Directly by a CSE based on a discovery or another event within the CSE.
- Indirectly by the Management Server or Management Client when an event (such as firmware update, or fault notification) occurs within the Management Server or Client.

Regardless of the Create, Update or Delete operation, the Originator of the operation will be authorized to perform the operation. In addition, at most one Management Server is able to Create, Delete or Update addressable elements of a Management Resource.

6.2.4.2 Detailed Descriptions

6.2.4.2.0 Overview

The DMG CSF provides capabilities for the purpose of managing M2M Devices/Gateways as well as devices in M2M Area Networks.

Managed Entity	Device Configuration Function (DCF)	Device Diagnostic and Monitoring Function (DDMF)	Device Firmware Management Function (DFMF)	Device Topology Management Function (DTMF)
M2M Device / Gateway				
M2M Area Network Device				

Figure 6.2.4.2.0-1: Device Management Entities and Functions

Such capabilities include:

- **Device Configuration Function (DCF):** This function includes the configuration of the capabilities of the M2M Device, M2M Gateway or device in the M2M Area Network.
- **Device Diagnostics and Monitoring Function (DDMF):** This function includes the troubleshooting through the use of diagnostic tests and retrieval of operational status and statistics associated with the M2M Device, M2M Gateway or device in the M2M Area Network.
- **Device Firmware Management Function (DFMF):** This function provides the software lifecycle management for firmware components and associated artifacts for the M2M Device, M2M Gateway or device in the M2M Area Network.
- **Device Topology Management Function (DTMF):** This function provides the management of the topology of the M2M Area Network. An M2M Area Network is comprised of ADNs and other devices in the M2M Area Network.

6.2.4.2.1 Device Configuration Function

The Device Configuration Function (DCF) provides the configuration of device capabilities that are necessary to support M2M Services and AEs in M2M Devices, M2M Gateways or devices in an M2M Area Network.

These device configuration capabilities include:

- Discovery of a device's management objects and attributes.
- Ability to enable or disable a device capability.
- Provisioning configuration parameters of a device.

6.2.4.2.2 Device Diagnostics and Monitoring Function

The Device Diagnostics and Monitoring Function (DDMF) permits the troubleshooting of device capabilities that are necessary to support M2M Services and AEs in M2M Devices, M2M Gateways or devices in an M2M Area Network.

These device diagnostic and monitoring capabilities include:

- Configuration of diagnostics and monitoring parameters on the device.
- Retrieval of device information that identifies a device and its model and manufacturer.
- Retrieval of device information for the software and firmware installed on the device.
- Retrieval of information related to a battery within the device.

- Retrieval of information associated with the memory in use by a device.
- Retrieval of the event logs from a device.
- Device reboot diagnostic operation.
- Device factory reset diagnostic operation.

6.2.4.2.3 Device Firmware Management Function

The Device Firmware Management Function (DFMF) provides lifecycle management for firmware associated with a device.

Device firmware is comprised of firmware modules and artefacts (e.g. configuration files) that are maintained on a device. A device can maintain more than one firmware image and the capability to manage individual firmware images. The firmware lifecycle includes actions to download, update or remove a firmware image. In addition firmware could be downloaded and updated within the same action.

6.2.4.2.4 Device Topology Management Function

The Device Topology Management Function (DTMF) is a function that is specific to M2M Gateways where an M2M Gateway maintains zero or more M2M Area Networks.

These device topology management capabilities include:

- Configuration of the topology of the M2M Area Network.
- Retrieval of information related to the devices attached to the M2M Area Network.
- Retrieval of information that describes the transport protocol associated with the M2M Area Network.
- Retrieval of information that describes the characteristics associated with online/offline status of devices in the M2M Area Network.

6.2.5 Discovery

6.2.5.1 General Concepts

The Discovery (DIS) CSF searches information about applications and services as contained in attributes and resources. The result of a discovery request from an Originator depends upon the filter criteria and is subject to access control policy allowed by M2M Service Subscription. An Originator could be an AE or another CSE. The scope of the search could be within one CSE, or in more than one CSE. The discovery results are returned back to the Originator.

6.2.5.2 Detailed Descriptions

The DIS CSF uses the Originator provided filter criteria (e.g. a combination of keywords, identifiers, location and semantic information) that can limit the scope of information returned to the Originator.

The discovery request indicates the address of the resource where the discovery is to be performed. Upon receiving such request, the DIS CSF discovers, identifies, and returns the matching information regarding discovered resources according to the filter criteria.

A successful response includes the discovered information or address(es) pertaining to the discovered resources. In the latter case the Originator can retrieve the resources using such discovered address. Based on the policies or Originator request, the CSE which received the discovery request can forward the request to other registered ASN-CSEs, MN-CSEs or IN-CSEs.

6.2.6 Group Management

6.2.6.1 General Concepts

The Group Management (GMG) CSF is responsible for handling group related requests. The request is sent to manage a group and its membership as well as for the bulk operations supported by the group. When adding or removing members to/from a group, it is necessary to validate whether the group member complies with the purpose of the group. Bulk operations include read, write, subscribe, notify, device management, etc. Whenever a request or a subscription is made via the group, the group is responsible for aggregating its responses and notifications. The members of a group can have the same role with regards to access control policy control towards a resource. In this case, access control is facilitated by grouping. When the Underlying Network provides broadcasting and multicasting capability, the GMG CSF is able to utilize such capability.

6.2.6.2 Detailed Descriptions

The GMG CSF enables the M2M System to perform bulk operations on multiple devices, applications or resources that are part of a group. In addition, the GMG CSF supports bulk operations to multiple resources of interest and aggregates the results. It facilitates access control based on grouping. When needed and available, the GMG CSF can leverage the existing capabilities of the Underlying Network including broadcasting/multicasting.

When facilitating access control using a group, only members with the same access control policy towards a resource are included in the same group. Also, only AEs or CSEs which have a common role with regards to access control policy are included in the same group. This is used as a representation of the role when facilitating role based access control.

The service functions supported by the GMG CSF are as follows:

- Handles the requests to create, retrieve, update, and delete a group. An AE or a CSE may request the creation/retrieve/update/deletion of a group as well as the addition and deletion of members of the group.
- Creates one or more groups in CSEs in any of the Nodes in oneM2M System for a particular purpose (e.g. facilitation of access control, device management, fan-out common operations to a group of devices, etc.).
- Handles the requests to retrieve the information (e.g. address, metadata, etc.) of a group and its associated members.
- Manages group membership and handles requests to add or remove members to and from a group's member list. A member may belong to one or more groups. A group may be a member of another group. When new members are added to a group, the GMG CSF validates if the member complies with the purpose of the group.
- Leverages the capabilities of other CSFs in order to fulfil the functionalities supported by the GMG CSF service functions. Examples include: Security CSF for authentication and authorization.
- Forwards requests to all members in the group. In case the group contains another group as a member, the forwarding process is done recursively, i.e. the nested group forwards the request to its members. After forwarding the request to all members in the group, the GMG CSF generates an aggregated response by aggregating the corresponding responses from the Group members.
- Supports subscriptions to individual groups. Subscriptions to a group is made only if the subscriber is interested in all members of the group. If subscription to a group is made, the GMG CSF aggregates the notifications from the group members, and notifies the subscriber with the aggregated notification. Responses and event notifications relevant to a subscription may be selectively filtered by filtering criteria.

6.2.7 Location

6.2.7.1 General Concepts

The Location (LOC) CSF allows AEs to obtain geographical location information of Nodes (e.g. ASN, MN) for location-based services. Such location information requests can be from an AE residing on either a local Node or a remote Node.

NOTE: Geographical location information can include more than simply the longitude and the latitude information.

6.2.7.2 Detailed Descriptions

The LOC CSF obtains and manages geographical location information based on requests from AEs residing on either a local Node or a remote Node. The LOC CSF interacts with any of the following:

- a location server in the Underlying Network;
- a GPS module in an M2M device; or
- information for inferring location stored in other Nodes.

In order to update the location information, an AE can configure an attribute (e.g. update period). Based on such defined attributes, the LOC CSF can update the location information using one of the location retrieval mechanisms listed above.

NOTE: The location technology (e.g. Cell-ID, assisted-GPS, and fingerprint) used by the Underlying Network depends on its capabilities.

The functions supported by the LOC CSF are as follows:

- Requests other Nodes to share and report their own or other Nodes' geographical location information with the requesting AEs.
- Provides means for protecting the confidentiality of geographical location information.

6.2.8 Network Service Exposure, Service Execution and Triggering

6.2.8.1 General Concepts

The Network Service Exposure, Service Execution and Triggering (NSSE) CSF manages communications with the Underlying Networks for accessing network service functions over the Mcn reference point. The NSSE CSF uses the available/supported methods for service "requests" on behalf of AEs. The NSSE CSF shields other CSFs and AEs from the specific technologies and mechanisms supported by the Underlying Networks.

NOTE: The NSSE CSF provides adaptation for different sets of network service functions supported by various Underlying Networks.

The network service functions provided by the Underlying Network include service functions such as, but not limited to, device triggering, small data transmission, location notification, policy rules setting, location queries, IMS services, device management. Such services do not include the general transport services.

6.2.8.2 Detailed Descriptions

The NSSE CSF manages communication with the Underlying Networks for obtaining network service functions on behalf of other CSFs, remote CSEs or AEs. The NSSE CSF uses the Mcn reference point for communicating with the Underlying Networks.

The M2M System allows the Underlying Networks to control network service procedures and information exchange over the Underlying Networks while providing such network services. For example, some Underlying Network can choose to provide the network services based on control plane signalling mechanisms.

Other CSFs in a CSE that need to use the services offered by the Underlying Network use the NSSE CSF.

The service functions supported by the NSSE CSF are as follows:

- The NSSE CSF shields other CSFs and AEs from the specific technology and mechanisms supported by the Underlying Networks.

NOTE: The NSSE CSF provides adaptation for different sets of network service functions supported by various Underlying Networks.

- The NSSE CSF maintains the necessary connections and/or sessions over the Mcn reference point, between the CSE and the Underlying Network when local CSFs are in need of a network service.
- The NSSE CSF provides information to the CMDH CSF related to the Underlying Network so the CMDH CSF can include that information to determine proper communication handling.

6.2.9 Registration

6.2.9.1 General Concepts

The Registration (REG) CSF processes a request from an AE or another CSE to register with a Registrar CSE in order to allow the registered entities to use the services offered by the Registrar CSE.

6.2.9.2 Detailed Descriptions

Registration is the process of delivering AE or CSE information to another CSE in order to use M2M Services.

An AE on an ASN, an MN or an IN performs registration locally with the corresponding CSE in order to use M2M services offered by that CSE. An AE on an ADN performs registration with the CSE on an MN or an IN in order to use M2M services offered by that CSE. An IN-AE performs registration with the corresponding CSE on an IN in order to use M2M services offered by that IN CSE. An AE can have interactions with its Registrar CSE (when it is the target CSE) without the need to have the Registrar CSE register with other CSE.

The CSE on an ASN performs registration with the CSE in the MN in order to be able to use M2M Services offered by the CSE in the MN. As a result of successful ASN-CSE registration with the MN-CSE, the CSEs on the ASN and the MN establish a relationship allowing them to exchange information.

The CSE on an MN performs registration with the CSE of another MN in order to be able to use M2M Services offered by the CSE in the other MN. As a result of successful MN-CSE registration with the other MN-CSE, the CSEs on the MNs establish a relationship allowing them to exchange information.

The CSE on an ASN or on an MN perform registration with the CSE in the IN in order to be able to use M2M Services offered by the CSE in the IN. As a result of successful ASN/MN registration with the IN-CSE, the CSEs on ASN/MN and IN establish a relationship allowing them to exchange information.

Following a successful registration of an AE to a CSE, the AE is able to access, assuming access privilege is granted, the resources in all the CSEs that are potential targets of request from the Registrar CSE.

The capabilities supported by the REG CSF are as follows:

- ability for AE to register to its Registrar CSE where the hop count is zero, as per table 6.4-1;
- ability for CSE to its Registrar CSE where the hop count is zero, as per table 6.4-1;
- ability for an ASN-CSE/MN-CSE to register association of its M2M-Ext-ID (if available) with its CSE-ID (see clause 7.1.8);
- ability for an ASN-CSE/MN-CSE to register association of its Trigger-Recipient-ID (if available) with its CSE-ID (see clause 7.1.10). When Trigger-Recipient-ID is not present, it is assumed that the CSE is not able to receive triggers.

NOTE: Such registrations are applicable to a single M2M Service Provider Domain.

Registration information for a Node includes:

- Identifier of the Node.
- Reachability schedules; which are elements of a Node's policy, and specify when messaging can occur between Nodes. Reachability schedules can be used in conjunction with other policy elements. When reachability schedules are not present in a Node then that Node is expected to be always reachable.
- Managing connection state of communication channel to the registered AE or CSE.

6.2.10 Security

6.2.10.1 General Concepts

The Security (SEC) CSF comprises the following functionalities:

- Sensitive data handling.
- Security administration.
- Security association establishment.
- Remote security provisioning;
- Identification and authentication;
- Authorization.
- Identity management.

Sensitive data handling functionality in the SEC CSF protects the local credentials on which security relies during storage and manipulation. Sensitive data handling functionality performs other sensitive functions such as security algorithms. This functionality is able to support several cryptographically separated security environments.

Security management capabilities are provided by the Security Administration functionality as specified in oneM2M TS-0003 [2].

NOTE: ASM and DMG CSFs do not include security management capabilities of the SEC CSF.

Security administration functionality enables services such as the following:

- Creation and administration of dedicated security environment supported by Sensitive Data Handling functionality.
- Post-provisioning of a root credential protected by the security environment.
- Provisioning and administration of subscriptions related to M2M Common Services and M2M Application Services.

Security association establishment functionality establishes security association between corresponding M2M Nodes, in order to provide services such as confidentiality and integrity.

6.2.10.2 Detailed Descriptions

The functionalities supported by the SEC CSF are as follows:

- Sensitive data handling:
 - Provides the capability to protect the local credentials on which security relies during storage and manipulation.
 - Extends sensitive data handling functionality to other sensitive data used in the M2M Systems such as subscription related information, access control policies and personal data pertaining to individuals.
 - Performs other sensitive functions as well, such as security algorithms running in cryptographically separated secure environments.
- Security administration:
 - Creates and administers dedicated secure environment supported by sensitive data handling functionality.
 - Post-provisions master credentials protected by the secure environment.

NOTE 1: The secure environment can also be pre-provisioned with a master credentials prior to deployment; therefore this capability is not always required. Post-provisioning is required when secure remote provisioning needs to be performed or re-initiated after deployment.

- Provisioning and administration of subscriptions related to M2M Services and M2M application services. Besides the associated master credentials, a subscription includes other information classified as sensitive data such as authorization roles and identifiers for access control management.
- Security association establishment:
 - Establishes security associations between corresponding M2M Nodes in order to provide specific security services (e.g. confidentiality, integrity, or support for application level signature generation and verification) involving specified security algorithms and sensitive data. This involves key derivation based on provisioned master credentials. This functionality of the SEC CSF is mandatory when security is supported.
- MAF-based security association establishment
 - These security frameworks use a M2M Authentication Function (MAF) to provide authentication and distribution of symmetric key for use by a Source End-Point initiating establishment of the symmetric key, and one or more target end-points. The symmetric key can be used in one of Security Association Establishment Framework, End-to-end security of Data (ESData) and End-to-end security of Primitives (ESPrim).
- End-to-end security of Data (ESData) and Primitives (ESPrim)
 - End-to-End Security of Primitives (ESPrim) allows a Hosting CSE or AE to authenticate the Originator of a request primitives that are handled by other CSEs. ESPrim also provides confidentiality and integrity protection of these request and response primitives. End-to-End Security of Data (ESData) provides an interoperable framework for protecting data such that it can be transported via transit CSEs which do not need to be trusted.
- Remote Security Provisioning
 - Remote Security Provisioning Frameworks (RSPFs) enable an M2M Enrolment Function (MEF) to provision credentials to an Enrollee, which is a CSE or AE, as part of the Enrolment of the Enrollee to an M2M SP or third party M2M Trust Enabler (MTE). The credentials are either a symmetric key shared by the Enrollee and an Enrolment Target or Certificate(s) for which the Enrollee knows the corresponding private key, and a set of trust anchors for authenticating the M2M SP or MTE's MAF or other entities enrolled with the M2M SP or MTE.
- Authorization:
 - Role Based Access Control (RBAC) allows the Hosting CSE to authorize accesses on resources according to the roles assigned to the Originators.
 - Token Based Access Control allows the Hosting CSE to authorize accesses on resources according to the authorization information in tokens provided by the Originators.
 - Dynamic Authorization provides an interoperable framework for an Originator to be dynamically issued with temporary permissions providing the Originator with access to one or more resources on one or more CSEs at runtime.
- Identity management:
 - Identity management in the oneM2M context covers the lifecycle (creation, storage and destruction) of identifiers related to oneM2M entities.

NOTE 2: This functionality is not part of the present release.

Detailed functionalities are described in the oneM2M TS-0003 [2].

6.2.11 Service Charging and Accounting

6.2.11.1 General Concepts

The Service Charging and Accounting (SCA) CSF provides charging functions for the Service Layer. It supports different charging models which also include online real time credit control. The SCA CSF manages service layer charging policies and configuration capturing service layer chargeable events, generating charging records and charging information. The SCA CSF can interact with the charging System in the Underlying Network also. The SCA CSF in the IN-CSE handles the charging information.

6.2.11.2 Detailed Descriptions

The SCA CSF performs information recording corresponding to a chargeable event based on the configured charging policies. The SCA CSF sends the charging information transformed from the specific recorded information to the billing domain by the use of a standard or proprietary interface for charging purposes.

The SCA CSF supports "independent service layer charging" and "correlated charging with the Underlying Network" charging system. For independent service layer charging, only charging functions in the M2M service layer are involved. For correlated charging, charging functions in both the service layer and the Underlying Network are involved.

The SCA CSF supports one or multiple charging models, such as the following:

- Subscription based charging: A service subscriber is charged based on service layer subscriptions.
- Event based charging: Charging is based on service layer chargeable events. A chargeable event refers to the discrete transactions. For example, an operation on data (Create, Update, Retrieve) can be an event. Chargeable event can also be timer based. Chargeable events are configurable to initiate information recording. More than one chargeable event can be simultaneously configured and triggered for information recording.

The Service Layer charging system consists of the following logical functions:

- Charging management function: This function handles charging related policies, configurations, function communications and interacting with the charging system in the Underlying Network. Charging related policies.
- Charging triggering function: This function resides in the service layer. It captures the chargeable event and generates recorded information for charging. Recorded information may contain mandatory and optional elements.
- Offline charging function: This function handles offline charging related operations. Offline charging does not affect services provided in real time. Charging triggering information is generated at the CSFs where the chargeable transaction happens. The offline charging function generates service charging records based on recorded information. A service charging record is a formatted collection of information about a chargeable event (e.g. amount of data transferred) for use in billing and accounting.

NOTE: Charging triggering and offline charging function are based on charging policies. The system may record information for other purposes such as for event logging. Some of such information may be applicable for charging purposes.

6.2.12 Subscription and Notification

6.2.12.1 General Concepts

The Subscription and Notification (SUB) CSF provides notifications pertaining to a subscription that tracks event changes on a resource (e.g. deletion of a resource). A subscription to a resource is initiated by an AE or a CSE, and is granted by the Hosting CSE subject to access control policies. During an active resource subscription, the Hosting CSE sends a notification regarding a notification event to the address(es) where the resource subscriber wants to receive it.

6.2.12.2 Detailed Descriptions

The SUB CSF manages subscriptions to resources, subject to access control policies, and sends corresponding notifications to the address(es) where the resource subscribers want to receive them. An AE or a CSE is the subscription resource subscriber. AEs and CSEs subscribe to resources of other CSEs. A subscription Hosting CSE sends notifications to the address(es) specified by the resource subscriber when modifications to a resource are made. The scope of a resource subscription includes tracking changes of attribute(s) and direct child resource(s) of the subscribed-to resource. It does not include tracking the change of attribute(s) of the child resource(s). Furthermore, the scope includes tracking operations on attributes and direct child resources, but does not include tracking operations on attributes of child resources. Each subscription may include notification policies that specify which, when, and how notifications are sent. These notification policies may work in conjunction with CMDH policies.

A subscription is represented as resource subscription in the CSE resource structure.

The functions supported by the SUB CSF are as follows:

- Inclusion of the resource subscriber ID, the hosting CSE-ID and subscribed-to resource address(es) per resource subscription request. It may also include other criteria (e.g. resource modifications of interest and notification policy) and the address(es) where to send the notifications.
- Ability to subscribe to a single resource via a single subscription, or subscribe to multiple resources via a single subscription when they are grouped and represented as a single group resource.

6.3 Security Aspects

oneM2M TR-0008 [i.25] on Analysis of Security Solutions for the oneM2M System differentiates security domains related to the transport layer (Underlying Network), service layer (M2M common services) and Application Layer. It also considers possible trust scenarios involving these different security domains, and investigates countermeasures to threats that potentially affect the security of the M2M System.

Each of the security domains may provide their own set of security capabilities. The oneM2M security solution shall provide configurable security services through an API for upper security domains to leverage, or enable the use of the exposed security features of other security domains when appropriate.

As a result, beyond providing security solutions that protect the integrity of the M2M Service Layer, the oneM2M architecture exposes, through its APIs, further security services that are made available to M2M Applications. This enables M2M Applications to benefit from security solutions deployed in the M2M Service Architecture, without adding redundant and/or proprietary security solutions.

NOTE: It remains the responsibility of M2M Application Service Providers to perform their own risk assessment process to identifying the specific threats affecting them and derive their actual security needs.

Security aspects are described in oneM2M TS-0003 [2].

6.4 Intra-M2M SP Communication

Within the same SP domain a CSE shall perform registration with another CSE over the Mcc reference point to be able to use M2M Services offered by that CSE and to allow the other CSE to use its services. As a result of successful registration the CSEs establish a relationship allowing them to exchange information.

An AE shall perform registration with a CSE in order to be able to use M2M Services offered by that CSE. As a result of successful AE registration, the AE and the CSE establish a relationship allowing them to exchange information.

Table 6.4-1 shows which oneM2M entity types shall be able to register with which other entity types.

Table 6.4-1: Entity Registration

Originator (Registree)	Receiver (Registrar)	Registration Procedure
ADN-AE	MN-CSE, IN-CSE	AE registration procedure see clause 10.1.1.2.2
ASN-AE	ASN-CSE	
MN-AE	MN-CSE	
IN-AE	IN-CSE	
ASN-CSE	MN-CSE, IN-CSE	CSE registration procedure see clause 10.1.1.2.1
MN-CSE	MN-CSE, IN-CSE	

The Originator (Registree) in table 6.4-1 requests the registration and the Receiver (Registrar) is responsible for verifying the request, and checking the authentication and authorization of the Originator in order to establish a peer relationship:

- An AE shall not be registered to more than one CSE (ASN-CSE, MN-CSE or IN-CSE).
- An ASN-CSE shall be able to be registered to at most one other CSE (MN-CSE or IN-CSE).
- An MN-CSE shall be able to be registered to at most one other CSE (MN-CSE or IN-CSE).

An MN-CSE shall be able to support only a single registration towards another MN-CSE or an IN-CSE. A concatenation (registration chain) of multiple uni-directional registrations shall not form a loop. E.g. two MN-CSEs A and B, cannot register with each other. Three MN-CSEs A, B and C, where A registers to B, and B registers to C, then C cannot register to A.

6.5 Inter-M2M SP Communication

6.5.1 Inter M2M SP Communication for oneM2M Compliant Nodes

6.5.1.0 Overview

To enable M2M entities (e.g. CSE, AE) in different M2M Service Provider (SP) domains to communicate, configuration within the M2M domain determines if such a communication is allowed. If allowed, the M2M System shall support routing of the traffic across the originating M2M SP domain and within the target M2M SP domain.

Communication between different M2M SPs which occurs over the reference point Mcc', is subject to business agreements. The offered functionality is typically a subset of the functionality offered over the Mcc reference point.

Any interM2M SP communication in support of a request originating from one M2M SP domain shall be processed and forwarded through the Infrastructure Node of the originating M2M domain towards the Infrastructure Node of the target M2M SP domain and finally forwarded to its target CSE, if different from the Infrastructure Node. Hence the Infrastructure Node in both M2M domains shall be the exit and entry points, respectively, for all inter M2M SP communication traffic.

In this configuration approach, public DNS shall be used to support traffic routing for inter M2M SP communication in accordance with [i.13]. This relies on public domain names being allocated to communicating CSE entities within the oneM2M architecture, and to whom access across domains is permitted through policies. To that effect, an M2M SP supporting inter- M2M SP communication shall ensure that the public domain names for the CSEs whose functionality is available across domains are held in its public DNS and shall always point to the IP address associated with the Infrastructure Node for the domain (being the entry point) for accessibility purposes.

The M2M SP could optionally also have additional policies (e.g. black list or white list) that governs accessibility from other domains to CSE functionality located within its own domain. These policies are however out of scope of the present document.

The public domain names of CSEs to whom access from other domains is allowed by policies, shall be created in the DNS of the M2M SP by the Infrastructure Node at registration time of these CSEs, and shall be removed at de-registration. DNS entries for CSEs can also be created/removed for registered CSEs at any time by the M2M SP through administrative means to handle dynamic policies.

6.5.1.1 Public Domain Names and CSEs

To enable the usage of public DNSs as described above, there is a need for a naming convention for public names for CSEs. This naming convention facilitates the creation of the necessary entries of the public domain names of CSEs in the DNS by the infrastructure node.

CSEs public domain names shall be a sub-domain of the Infrastructure Node's public domain name. This naming convention allows the Infrastructure Node to include the needed DNS entry corresponding to the CSE to whom access from other domains is allowed. This would typically occur when the CSE registers with the Infrastructure Node, subject to policies, or administratively.

Accordingly, the structure of the public domain of the CSEs in IN/MN/ASN shall follow the following naming convention, which relies on the CSE identifier (CSE-ID) as part of the naming convention to facilitate the DNS entry creation:

- Infrastructure Node CSE public domain name: <Infrastructure Node CSE Identifier>.<M2M Service Provider domain name>.
- Middle Node CSE public domain name: <Middle Node CSE Identifier>.<Infrastructure Node public domain name>.
- Application Service Node CSE public domain name: <Application Service Node CSE Identifier>.<Infrastructure Node public domain name>.

Both the MN-CSE and the ASN-CSE public domain names are sub-domains of the Infrastructure Node public domain name.

The A/AAAA records in the DNS, as per [i.7], [i.9] and [i.12] shall consist of the public domain name of the CSE and the IP address of the M2M Infrastructure Node, since the M2M Infrastructure Node is the entry point of the M2M Service Provider domain name where it belongs to.

Note that entries in the public domain names of the three nodes depicted above do not imply that the actual CSE-Identifier allocated for that node has to be used in the DNS entry. Rather any name, including indeed the CSE Identifier for the node, can be used there as long as the entry resolves to the intended Node.

EXAMPLE:

These 3 host entries are valid entries in the DNS:

- MN-CSEID.IN-CSEID.m2m.myoperator.org
- node1.node2.m2m.myoperator.org
- MN-CSEID.node22.m2m.myoperator.org

6.5.2 Inter M2M SP Generic Procedures

6.5.2.0 Overview

This clause describes the behaviour of the M2M Nodes in support of inter-M2M SP procedures.

6.5.2.1 Actions of the Originating M2M Node in the Originating Domain

The Originator in the originating domain can be any M2M Node such as ADN, an MN, or an ASN, and shall send a request to the Registrar CSE to retrieve a resource located in another M2M SP domain.

The Originator shall use any of the options defined in clause 9.3.1 to identify the target host and resource for that purpose.

6.5.2.2 Actions of the Receiving CSE in the Originating Domain

The receiving CSE in the originating domain shall check if the addressed resource is locally available. If the addressed resource is not locally available, then the request shall be forwarded to the next CSE.

If the receiving CSE is on an IN, it shall check if the addressed resource is locally available within its domain. If the addressed resource is not located within its own domain, then the IN shall perform a DNS lookup by using the target hostname provided in the RETRIEVE request. A successful DNS lookup shall return to the origin IN in the originating domain the IP address of the M2M IN residing in the target M2M SP domain.

Subsequently, the IN in the originating domain shall forward the request to the IN of the target domain.

6.5.2.3 Actions in the IN of the Target Domain

The IN is the entry point of the target M2M SP domain. The IN shall check if the addressed resource is a local resource. If it is not a local resource it shall forward the request to the appropriate CSE, after identifying the Hosting CSE within its domain, using the pointOfAccess attribute.

Once the request reaches the target Hosting CSE, the CSE shall apply the access control policies applicable to the request. Consequently, the Hosting CSE shall forward the response for the incoming request following the same path of the incoming request.

6.5.3 DNS Provisioning for Inter-M2M SP Communication

6.5.3.0 Overview

As specified previously, any M2M SP supporting inter-M2M SP communication shall ensure that the public domain names for the CSEs whose functionality is available across domains are held in the M2M SP's DNS and shall always point to the IP address associated with the Infrastructure domain CSE (being the entry point) for accessibility purposes.

This implies that the IN-CSE shall be responsible for creating the appropriate entry in the DNS for a successfully registered CSE in the IN-CSE, if the M2M SP policies do allow access to the CSE across multiple M2M domains. Similarly the IN-CSE shall be responsible for deleting the appropriate entry in the M2M SP's DNS for a successfully de-registered CSE in the IN-CSE if the M2M SP policies do allow access to the CSE across multiple M2M domains.

6.5.3.1 Inter-M2M SP Communication Access Control Policies

Additional M2M SP policies that further restrict access to CSEs to requests originating from configured M2M SPs only, can complement the DNS entries created by the IN-CSE. These policies are out of scope of the present document.

6.5.4 Conditional Inter-M2M Service Provider CSE Registration

Inter-M2M Service Provider CSE registration shall be supported to enable M2M entities (e.g. CSE, AE) in peer M2M Service Provider (SP) domains with the ability to create and operate resources with the equivalent set of possibilities as offered in the intra-M2M Service Provider domain, subject to the following:

- The AE or CSE in either domain requires a representation of its own domain, notably the IN-CSE of its domain, in the peer domain to create resources in the peer domain. As an example, when it is required for an AE or a CSE to create and operate under the representation of an IN-CSE resource from a different M2M SP Domain. This enables the AE or CSE to have a behaviour that is identical in both the intra- and inter-M2M SP cases.

An AE or CSE that does not require to use the remoteCSE representations of the other domain as parent resources, can create resources in the peer domain if it knows the parent of the resource to be created and as such does not require IN to IN registration. Hence creating subscriptions within a peer M2M SP shall not require IN to IN registration between peer domains (but remains subject to inter -M2M SP business agreements, and access control policies).

Registration between M2M SPs occurs over the reference point Mcc', and is subject to business agreements. These agreements can limit the offered functionalities in comparison to those offered over the Mcc reference point.

No additional security is required respect to the basic procedure as described in clauses 6.5.1, 6.5.2 and 6.5.3.

Table 6.5.4-1 shows which oneM2M entity types can register with which other entity types across the Mcc' reference point.

Table 6.5.4-1: Inter M2M SP Entity Registration

Originator (Registree)	Receiver (Registrar)	Registration Procedure
IN-CSE	IN-CSE	CSE registration procedure. See clause 10.1.1.2.1

An IN-CSE is allowed to register to the IN-CSE of multiple different M2M SP domains in the oneM2M System.

Any inter-M2M SP communications in support of a request originating from one M2M SP domain shall be processed and forwarded through the IN of the originating M2M domain towards the IN of the target M2M SP domain and finally forwarded to its target CSE, if different from the target domain's IN. Hence the IN in both M2M domains shall be the exit and entry points, respectively, for all inter-M2M SP communication traffic.

6.6 M2M Service Subscription

The M2M Service Subscription defines the technical part of the contract between an M2M Subscriber (typically an M2M Application Service Provider) and an M2M Service Provider. Each M2M Service Subscription shall have a unique identifier, the M2M-Sub-ID, as specified in clause 7.1.6. An M2M Service Subscription establishes a link between one or more AEs; one or more M2M Nodes.

How to authorize the request operation based on M2M Service Subscription resource are defined in oneM2M TS-0003 [2].

An M2M Service Subscription shall be used for the following purposes:

- Serve as a basis for authorization for resource operations.
- Serve as the basis for charging.
- Identify which Nodes are part of this M2M Service Subscription.

7 M2M Entities and Object Identification

7.1 M2M Identifiers

7.1.0 Overview

This clause provides a list of identifiers required for the purpose of interworking within the oneM2M architectural model.

An M2M identifier is a sequence of characters used to refer to an entity (such as CSE or an AE), a resource (such as defined in clause 9) or an object (such as an M2M Service Provider or an M2M Node) defined in oneM2M. An M2M identifier has a consistent meaning when applied (i.e. it refers consistently to the same resource, entity or object for the duration of their lifetime, as defined in the clause 7.2) in a particular context.

7.1.1 M2M Service Provider Identifier (M2M-SP-ID)

An M2M Service Provider shall be uniquely identified by the M2M Service Provider Identifier (M2M-SP-ID). This is a static value assigned to the Service Provider.

7.1.2 Application Entity Identifier (AE-ID)

An Application Entity Identifier (AE-ID) uniquely identifies an AE resident on an M2M Node, or an AE that requests to interact with an M2M Node. An AE-ID shall identify an Application Entity for the purpose of all interactions within the M2M System.

The AE-ID is globally unique and when used internally within a specific M2M SP domain, it is sufficient to be unique within that M2M Service Provider domain. It is extended to become globally unique when used outside the M2M Service Provider boundaries. The IN-CSE shall perform this task of adding or removing identifier portions (identifying the M2M SP) according to clause 7.2.

Additionally the AE-ID, when used in the context of a specific CSE where the AE is registered, it is sufficient to be unique within the scope of that specific CSE. It is extended to become M2M Service Provider unique when used outside such specific CSE.

The Hosting CSE of the AE shall perform this task of adding or removing the identifier portions according to clause 7.2.

7.1.3 Application Identifier (App-ID)

An Application Identifier (App-ID) uniquely identifies an M2M Application in a given context. More precisely, there are two types of App-ID: registration authority defined App-ID (registered App-ID) and non-registered App-ID. The establishment of the registered App-ID is guaranteed to be globally unique; the non-registered App-ID is not guaranteed to be globally unique. The detail format is described in clause 7.2.

7.1.4 CSE Identifier (CSE-ID)

A CSE shall be identified by a unique identifier, the CSE-ID, when instantiated within an M2M Node in the M2M System.

The CSE-ID is unique in an M2M Service Provider Domain. It becomes globally unique when the M2M-SP-ID is added in front.

The CSE-ID in a resource identifier (e.g. the *To* parameter) indicates the Hosting CSE of the resource.

7.1.5 M2M Node Identifier (M2M-Node-ID)

An M2M Node, hosting a CSE and/or Application(s) shall be identified by a globally unique identifier, the M2M-Node-ID.

The M2M System shall allow the M2M Service Provider to set the CSE-ID and the M2M-Node-ID to the same value.

The M2M-Node-ID enables the M2M Service Provider to bind a CSE-ID to a specific M2M Node.

Examples of allocating a globally unique M2M-Node-ID include the use of Object Identity (OID) and IMEI. For details on OID, see annex H.

7.1.6 M2M Service Subscription Identifier (M2M-Sub-ID)

The M2M-Sub-ID enables the M2M Service Provider to bind application(s), M2M Nodes, CSEs and services identified by service identifiers, as well as administrative information, such as billing address, etc., to a particular M2M Service Subscription between an M2M subscriber and the M2M Service Provider. The M2M-Sub-ID is unique for every M2M subscriber.

The M2M Service Subscription Identifier has the following characteristics:

- belongs to the M2M Service Provider;
- identifies the subscription to an M2M Service Provider;
- enables communication with the M2M Service Provider;
- can differ from the M2M Underlying Network Subscription Identifier.

There can be multiple M2M Service Subscription Identifiers per M2M Underlying Network subscription.

The M2M-Sub-ID shall not be exposed over any interface.

7.1.7 M2M Request Identifier (M2M-Request-ID)

The M2M-Request-ID tracks a Request initiated by an AE over the Mca reference point, and by a CSE over the Mcc reference point, if applicable, end to end. It is also included in the Response to the Request over the Mca or Mcc reference points.

To enable an AE to track Requests and corresponding Responses over the Mca reference point, AEs shall include a distinct M2M Request Identifier per request over the Mca Reference point to the CSE for any initiated request.

The CSE shall make such M2M Request Identifier unique by prepending the AE-ID-Stem (see clause 7.2) and slash('/') in front of it (e.g. C190XX7T/001).

If the CSE creates an M2M Request Identifier, then the CSE shall maintain a binding between the M2M Request Identifier received from the AE and the M2M Request Identifier it created in its interactions towards other peer CSEs. The CSE shall include the M2M Request Identifier received from the AE in its Response to the AE. This binding shall be maintained by the CSE until the Request message sequence is completed. Note that the Request initiated by the CSE could be the result of an application Request, or a request initiated autonomously by the CSE to fulfil a service.

In case an IN-CSE needs to send a request to a receiving CSE that is not reachable over any of the underlying networks, the IN-CSE initiates the procedure for "waking up" the Node hosting the receiving CSE by using procedures such as device triggering over the Mcn reference point. For Device Triggering, the triggering reference number to co-relate device triggering response is independent of the M2M Request Identifier. An IN-CSE may use the same value of an M2M-Request-Identifier in an incoming request for the triggering reference number in its interaction with the underlying network.

A CSE receiving a Request from a peer CSE shall include the received M2M Request Identifier in all additional Requests unspanned (i.e. 1:1) it has to generate (including propagation of the incoming Request) and that are associated with the incoming Request, where applicable.

If a Receiver CSE receives a request from an Originator for which another request with the same Request Identifier is already pending, the request shall be rejected. Otherwise - even if the same Request Identifier was already used by the same Originator sometime in the past, the request shall be treated as a new request.

7.1.8 M2M External Identifier (M2M-Ext-ID)

The M2M-Ext-ID is used by an M2M Service Provider (M2M SP) when services targeted to a CSE, identified by a CSE-ID, are requested from the Underlying Network.

The M2M External Identifier allows the Underlying Network to identify the M2M Device (e.g. ASN, MN) associated with the CSE-ID. To that effect, the Underlying Network maps the M2M-Ext-ID to the Underlying Network specific Identifier it allocated to the target M2M Device. In addition, the M2M SP shall maintain the association between the CSE-ID, the M2M-Ext-ID and the identity of the Underlying Network.

Both pre-provisioned and dynamic association between the CSE-ID with the M2M-Ext-ID are supported.

NOTE 1: For each CSE-ID, there is only one M2M-Ext-ID for a specific UNetwork-ID. Hence an M2M SP interworking with multiple Underlying Networks has different M2M-Ext-IDs associated with the same CSE-ID, one per Underlying Network and selects the appropriate M2M-Ext-ID for any service request it initiates towards an Underlying Network.

NOTE 2: The mapping by the Underlying Network of the M2M-Ext-ID to the M2M Device is Underlying Network specific.

NOTE 3: The Underlying Network provider and the M2M Service Provider collaborate for the assignment of an M2M-Ext-ID to each CSE identified by CSE-ID. At the same time, the Underlying Network provider maintains association of the M2M-Ext-ID with the Underlying Network specific Identifier allocated to the M2M device that hosts such CSE.

For pre-provisioned M2M-Ext-IDs, the M2M-Ext-ID along with the associated CSE-ID shall be made available at the Infrastructure Node. The CSE at M2M device does not need to have knowledge of the M2M-Ext-ID assigned to it.

For dynamic M2M-Ext-IDs, the M2M-Ext-ID specific to the Underlying Network shall be made available at the M2M device in the Field Domain. Such M2M-Ext-ID shall be conveyed to the IN-CSE during CSE Registration.

7.1.9 Underlying Network Identifier (UNetwork-ID)

The UNetwork-ID is used for identifying an Underlying Network. UNetwork-ID is a static value and unique within a M2M Service Provider domain.

One or more Underlying Networks may be available at an M2M Node offering different sets of capabilities, availability schedules etc. Based on the "policy" information at the Node and the capabilities offered by the available Underlying Networks, appropriate Underlying Network can be chosen by using UNetwork-ID. For example, based on "policy", scheduling of traffic triggered by a certain event category in certain time periods may be allowed over Underlying Network "WLAN" but may not be allowed over Underlying Network "2G Cellular".

7.1.10 Trigger Recipient Identifier (Trigger-Recipient-ID)

The Trigger-Recipient-ID is used when device triggering services are requested from the Underlying Network, to identify an instance of an ASN/MN-CSE on an execution environment, to which the trigger is routed.

EXAMPLE: When 3GPP device triggering is used, the Trigger-Recipient-ID maps to the Application-Port-Identifier (3GPP TS 23.682 [i.14]).

NOTE 1: For pre-provisioned M2M-Ext-IDs, Trigger-Recipient-ID is provisioned at the Infrastructure Node along with the M2M-Ext-ID and the associated CSE-ID.

NOTE 2: For dynamic M2M-Ext-IDs, Trigger-Recipient-ID specific to the Underlying Network is provisioned at each M2M device in the Field Domain. Such Trigger-Recipient-ID is conveyed to the IN-CSE during CSE Registration.

7.1.11 Void

7.1.12 Void

7.1.13 M2M Service Profile Identifier (M2M-Service-Profile-ID)

An M2M Service Profile Identifier defines applicable rules governing the AEs registering with M2M Nodes and the AEs residing on these nodes. Every M2M Service Profile is allocated an identifier so it can be retrieved for verification purposes.

The M2M-Service-Profile-ID enables the M2M Service Provider to bind AE(s), applicable rules to these AEs, as well as M2M Service Roles to M2M nodes.

An M2M-Service-Profile-ID shall be allocated to every M2M Node.

The M2M Service Profile Identifier has the following characteristics:

- belongs to the M2M Service Provider;
- identifies applicable rules governing AEs registering with an M2M node.

7.1.14 Role Identifier (Role-ID)

A Role identifier (Role-ID) is an identifier that a request originator may use in order to allow the CSE to enforce access control for resources. An originator may only use a Role-ID that is allowed by his service subscription profile.

7.1.15 Token Identifier (Token-ID)

A Token identifier (Token-ID) is the identifier for a Token. The Token-ID is assigned by the issuer of the Token.

Token-IDs shall meet the following criteria:

- A Token-ID shall identify the issuer of the Token.

- The Token-ID's uniqueness shall be global, with the proviso that a Token-ID value assigned to a Token may be assigned to another Token once the former Token has expired.

7.1.16 Local Token Identifier (Local-Token-ID)

A local token identifier (Local-Token-ID) is an identifier for a Token which can be assigned by a Hosting CSE making an accessing decision when it receives a request from an Originator which includes that Token or Token-ID in the request parameters (see clause 11.5.3).

In these scenarios, the request from the Originator included either the Token or the Token's Token-ID assigned by the Token's Issuer (see clause 7.1.15). In the latter case the Hosting CSE retrieves the Token using the Token-ID. The Hosting CSE assigns a Local-Token-ID to the Token. In the corresponding response message, the Hosting CSE provides the Originator with the mapping from the Local-Token-ID to the corresponding Token-ID. In subsequent requests to the Hosting CSE, the Originator can provide the Local-Token-ID in the place of the corresponding Token-ID or Token. The intention is that the Local-Token-ID would be significantly shorter than the Token or issuer-assigned Token-ID in order to reduce the size of the subsequent request messages. For more details regarding the use of Local-Token-ID, see clause 11.5.3.

Local-Token-IDs shall meet the following criteria:

- The Local-Token-ID shall be assigned by the Hosting CSE making access decisions using the corresponding Token.
- The Local-Token-ID's uniqueness shall be local to the Hosting CSE, with the proviso that a Local-Token-ID value assigned to a Token may be assigned to another Token once the former Token has expired.

7.2 M2M-SP-ID, CSE-ID, App-ID and AE-ID and resource Identifier formats

As a general rule, the identifiers of AEs, CSEs and resources are globally unique. In order to optimize their use, the identifiers shall be shortened when their scope can be derived from their context of use by the CSEs and the AEs. Such shortened identifiers are defined as 'relative' formats of the identifiers.

The M2M system shall use the identifiers M2M-SP-ID, CSE-ID, App-ID and AE-ID and resource identifiers according to the formats and the rules specified in the following table (table 7.2-1).

Table 7.2-1: Identifier formats and rules of use

Identifier Name	Absolute & Format-Designator or Relative & Format-Designator & Context	Format	Rule of use
M2M-SP-ID	Absolute M2M-SP-ID	The M2M-SP-ID shall conform to the FQDN format is defined in the IETF RFC 1035 [i.7] prefixed by '//' The format then has the structure of ://{FQDN} Where {FQDN} is a placeholder for the Fully Qualified Domain Name of the M2M Service Provider Domain Examples: - //www.m2mprovider.com - //globalm2m.org	Whenever The M2M-SP-ID is used, only an Absolute format of the M2M-SP-ID defined herein applies

Identifier Name	Absolute & Format-Designator or Relative & Format-Designator & Context	Format	Rule of use
		<p>The following two M2M-SP-IDs could be used to separate two service segments:</p> <ul style="list-style-type: none"> - //automotive.m2m.telematics-service-company.com - //building-management.m2m.telematics-service-company.com 	
CSE-ID	<p>Relative</p> <p>SP-relative-CSE-ID</p> <p>Context: M2M Service Provider Domain of the CSE</p>	<p>The SP-relative-CSE-ID begins with a slash character '/' and is followed by a sequence of characters that may include any of the unreserved characters defined in the clause 2.3 of the IETF RFC 3986 [i.10].</p> <p>The SP-relative-CSE-ID is unique within the context of the M2M-SP Domain hosting the CSE.</p> <p>The M2M-SP is assigning the SP-Relative-CSE-ID and is responsible for guaranteeing that the SP-Relative-CSE-ID is unique in the context of the hosting M2M-SP Domain.</p> <p>Examples:</p> <ul style="list-style-type: none"> • /123A38ZZY • /CSE090112 • /3ace4fd3 	<p>On the Mca and Mcc reference points: to refer to CSEs that are in the same M2M Service Provider Domain of the Receiver CSE.</p>
	<p>Absolute</p> <p>Absolute-CSE-ID</p>	<p>Concatenation according to the format</p> <p>{M2M-SP-ID}{SP-relative-CSE-ID}</p> <p>where {M2M-SP-ID} and {SP-relative-CSE-ID} are placeholders for the M2M-SP-ID and the SP-relative-CSE-ID format of the CSE-ID, respectively.</p> <p>The Absolute-CSE-ID complies with what is specified in clause 3 of IETF RFC 3986 [i.10] under "hier-part".</p> <p>Examples:</p> <ul style="list-style-type: none"> • //www.m2mprovider.com/C3219 • //m2m.thingscompany.com/ab3f124a 	<p>On Mca , Mcc and Mcc' reference points: to refer to CSEs that are in different M2M Service Provider Domains</p>

Identifier Name	Absolute & Format-Designator or Relative & Format-Designator & Context	Format	Rule of use
AE-ID	Relative AE-ID-Stem Context: <ul style="list-style-type: none"> • Registrar CSE of the AE or • M2M Service Provider Domain of the AE 	<p>The AE-ID-Stem is a sequence of characters that may include any of the unreserved characters defined in the clause 2.3 of the IETF RFC 3986 [i.10].</p> <p>The first character of the AE-ID-Stem has a specific meaning and its value shall be as follows:</p> <ol style="list-style-type: none"> 1. First character of AE-ID-Stem is 'C' The AE-ID-Stem is assigned by the Registrar CSE of the AE. In this case, the AE-ID-Stem shall be unique within the context of the Registrar CSE of the AE. The Hosting CSE is responsible for guaranteeing that the AE-ID-Stem is unique in the context of the Hosting CSE. <p>Examples:</p> <ul style="list-style-type: none"> • C190XX7T • Ca3e3f3ab <ol style="list-style-type: none"> 2. First character of AE-ID-Stem is 'S': The AE-ID-Stem is assigned by the M2M-SP. In this case, the AE-ID-Stem shall be unique within the context of the M2M-SP Domain. The M2M-SP is responsible for guaranteeing that the AE-ID-Stem is unique in the context of the M2M-SP Domain. <p>Examples:</p> <ul style="list-style-type: none"> • S190XX7T • Sa3e3f3ab <p>Use of other values for the first character of AE-ID-Stem is reserved. Which of the cases above shall apply will be determined during the AE registration procedure. The details of the process how an AE-ID-Stem unique within the M2M-SP Domain is assigned by the M2M-SP are described in the AE registration procedure description.</p>	On the Mca reference point: to refer to AEs that registered to the Receiver CSE .

Identifier Name	Absolute & Format-Designator or Relative & Format-Designator & Context	Format	Rule of use
	Relative SP-relative-AE-ID Context: M2M Service Provider Domain of the AE	<ol style="list-style-type: none"> In the case the AE-ID-Stem starts with the letter 'C', the SP-relative-AE-ID is a concatenation according to the format $\{SP\text{-relative-CSE-ID}\}\{AE\text{-ID-Stem}\}$ where $\{SP\text{-relative-CSE-ID}\}$ and $\{AE\text{-ID-Stem}\}$ are placeholders for the SP-relative-CSE-ID of the Registrar CSE of the AE and the AE-ID-Stem format of the AE-ID, respectively. Examples: <ul style="list-style-type: none"> /CSE090112/C190XX7T /3ace4fd3/Ca3e3f3ab In the case the AE-ID-Stem starts with the letter 'S', the AE-ID-Stem is unique within the M2M-SP Domain. In that case the SP-relative-AE-ID is a concatenation according to the format $\{/AE\text{-ID-Stem}\}$ where $\{AE\text{-ID-Stem}\}$ is a placeholders for the AE-ID-Stem format of the AE-ID. Examples: <ul style="list-style-type: none"> /S190XX7T /Sa3e3f3ab <p>The SP-relative-AE-ID begins with a slash character '/', and it complies with what is specified in clause 4.2 of IETF RFC 3986 [i.10] under "absolute-path reference".</p>	On the Mca and Mcc reference points: to refer to AEs in the same M2M Service Provider Domain.
	Absolute Absolute-AE-ID	<p>The Absolute-AE-ID format of the AE-ID is a concatenation according to the format: $\{M2M\text{-SP-ID}\}\{SP\text{-relative-AE-ID}\}$ where $\{M2M\text{-SP-ID}\}$ and $\{SP\text{-relative-AE-ID}\}$ are placeholders for the M2M-SP-ID and the SP-relative-AE-ID format of the AE-ID, respectively. The absolute AE-ID complies with what is specified in clause 3 of IETF RFC 3986 [i.10] under "hier-part". Examples: <ul style="list-style-type: none"> //m2m.prov.com/CSE3219/C9886 //m2m.things.com/ab3f124a/Ca2efb3f4 //m2m.things.com/S98821 </p>	On the Mca, Mcc and Mcc' reference points: to refer to AEs that are in different M2M Service Provider Domains

Identifier Name	Absolute & Format-Designator or Relative & Format-Designator & Context	Format	Rule of use
Resource identifier	Relative Unstructured-CSE-relative-Resource-ID Context: CSE hosting the Resource	<p>An Unstructured-CSE-relative-Resource-ID is a sequence of characters that may include any of the unreserved characters defined in the clause 2.3 of the IETF RFC 3986 [i.10].</p> <p>An Unstructured-CSE-relative-Resource-ID is unique in the context of the CSE hosting the resource.</p> <p>The Hosting CSE of the resource is responsible for guaranteeing that Unstructured-CSE-relative Resource-IDs are unique in the context of the Hosting CSE.</p> <p>Examples:</p> <ul style="list-style-type: none"> - container123 - a1b2c3d4b0b00f0fa66a123456789abc - xyz1234 	On the Mca and Mcc reference point: to refer to resources that are hosted by the CSE which is the Registrar CSE of the Originator.

<p>Relative Structured-CSE- relative- Resource-ID</p> <p>Context: CSE hosting the resource</p>	<p>A Structured-CSE-relative-Resource-ID is a sequence of characters that may include any of the unreserved characters defined in the clause 2.3 of the IETF RFC 3986 [i.10], as well as the slash character. It shall not start with the slash character.</p> <p>A Structured-CSE-relative Resource-ID is unique in the context of the CSE hosting the resource. The structure represents a chain of parent-child-relationships using resource IDs or resource names of parents and resource names of their children for segments that are separated by the '/' character. The first segment is one of the following:</p> <ul style="list-style-type: none"> • the resource name of <CSEBase> resource, • the character "-" (dash) as a shortcut for the resource name of <CSEBase> resource, • the Unstructured-CSE-relative-Resource-ID of a parent resource on the Hosting CSE. <p>The Hosting CSE of the resource is responsible for guaranteeing that resource names - which are used to construct Structured-CSE-relative-Resource-ID formats - are unique in the context of a set of sibling resources sharing the same parent resource on the Hosting CSE.</p> <p>Examples:</p> <ul style="list-style-type: none"> - bigCSE025/mainStreet/house5432/livingRoom/temperature <p>This example is the Structured-CSE-relative-Resource-ID of a <container> resource, where "bigCSE025" is assumed to be the name of the <CSEBase> resource, followed by four "/"-separated segments with names of <container> resources that are nested child resources thereof.</p> <ul style="list-style-type: none"> - CSE-Building-A3/HVAC-AE/WaterTemp/sample0098 <p>This example is the Structured-CSE-relative-Resource-ID of a <contentInstance> resource, where "CSE-Building-A3" is assumed to be the name of the <CSEBase> resource, followed by "/" plus the name "HVAC-AE" of an <AE> child resource, followed by "/" plus the name "WaterTemp" of a <container> child resources, followed by "/" plus the name "sample0098" of a child <contentInstance> resource.</p> <ul style="list-style-type: none"> - /HVAC-AE/WaterTemp/sample0098 <p>This example is the Structured-CSE-relative-Resource-ID of a <contentInstance> resource, where the dash symbol "-" is used as a shortcut for the name of the <CSEBase> resource, followed by "/" plus the name "HVAC-AE" of an <AE> child resource, followed by "/" plus the name "WaterTemp" of a <container> child resource, followed by "/" plus the name "sample0098" of a child <contentInstance> resource.</p> <ul style="list-style-type: none"> - 000AFE030003/sample0098 <p>This example is the Structured-CSE-relative-</p>	<p>On the Mca and Mcc reference point: To refer to resources that are hosted by the CSE receiving a request targeting a resource.</p>
--	--	---

Identifier Name	Absolute & Format-Designator or Relative & Format-Designator & Context	Format	Rule of use
		Resource-ID of a <contentInstance> resource, where "000AFE030003" is assumed to be the Unstructured-CSE-relative-Resource-ID of a <container> resource, followed by "/" plus the name "sample0098" of a child <contentInstance> resource.	
	Relative SP-relative Resource-ID Context: M2M Service Provider Domain of the resource	Concatenation according to the format: {SP-relative-CSE-ID}/{Unstructured-CSE-relative Resource ID} {SP-relative-CSE-ID}/{Structured-CSE-relative Resource ID} where {SP-relative-CSE-ID}, {Unstructured-CSE-relative Resource ID}, {Structured-CSE-relative Resource ID} are placeholders for the SP-relative-CSE-ID format of the CSE-ID and the Unstructured-CSE-relative-Resource-ID or a Structured-CSE-relative-Resource-ID format of the Resource ID, respectively. The SP-relative-Resource-ID begins with a slash character, and it complies with what is specified in clause 4.2 of IETF RFC 3986 [i.10] under "absolute-path reference". The SP-relative Resource ID is unique in the context of the Service Provider. Examples: - /CSE987776/a234361 This example is the SP-relative Resource-ID of a resource - not assuming any specific resource type - where the resource is hosted on a CSE with the SP-relative-CSE-ID "/CSE987776" and where the Unstructured-CSE-relative-Resource-ID is "a234361". - /CSE00030F003A/CSE-Building-A3/HVAC-AE/WaterTemp/sample0098 This example is the SP-relative Resource-ID of a <contentInstance> resource, where the targeted resource is hosted on a CSE with the SP-relative-CSE-ID "/CSE00030F003A" and where the CSE-ID is followed by "/" plus the name "CSE-Building-A3" of the <CSEBase> resource, followed by "/" plus the name "HVAC-AE" of an <AE> child resource, followed by "/" plus the name "WaterTemp" of a <container> child resource, followed by "/" plus the name "sample0098" of the targeted child <contentInstance> resource. - /CSE00030F003A/-/HVAC-AE/WaterTemp/sample0098	On the Mca and Mcc reference points: to refer to resources that are hosted by the CSE in the same M2M Service Provider Domain as the Originator.

Identifier Name	Absolute & Format-Designator or Relative & Format-Designator & Context	Format	Rule of use
		<p>This example is the SP-relative Resource-ID of a <contentInstance> resource, where the targeted resource is hosted on a CSE with the SP-relative-CSE-ID "/CSE00030F003A" and where the CSE-ID is followed by "/" plus the dash symbol "-" as a shortcut for the name of the <CSEBase> resource, followed by "/" plus the name "HVAC-AE" of an <AE> child resource, followed by "/" plus the name "WaterTemp" of a <container> child resource, followed by "/" plus the name "sample0098" of the targeted child <contentInstance> resource.</p> <ul style="list-style-type: none"> - /CSE00030F003A/000AFE030003/sample0098 <p>This example is the SP-relative Resource-ID of a <contentInstance> resource, where the targeted resource is hosted on a CSE with the SP-relative-CSE-ID "/CSE00030F003A" and where the CSE-ID is followed by "/" plus the Unstructured-CSE-relative-Resource-ID "000AFE030003" of a <container> resource, followed by "/" plus the name "sample0098" of the targeted child <contentInstance> resource.</p>	
	<p>Absolute Absolute Resource ID</p>	<p>Concatenation according to the format: {M2M-SP-ID}{SP-relative Resource ID} where {M2M-SP-ID} and {SP-relative Resource ID} are placeholders for the M2M-SP-ID and the SP-relative Resource ID format of the Resource ID, respectively.</p> <p>The Absolute-CSE-ID complies with what is specified in clause 3 of IETF RFC 3986 [i.10] under "hier-part".</p> <p>Examples:</p> <ul style="list-style-type: none"> - //www.m2mprovider.com / CSE987776/a234361 <p>This example is the Absolute Resource-ID of a resource - not assuming any specific resource type - where the resource is hosted within the domain of the M2M-Service Provider with the M2M-SP-ID "/www.m2mprovider.com" on a CSE with SP-relative-CSE-ID "/CSE987776" and where the Unstructured-CSE-relative-Resource-ID of the targeted resource is "a234361".</p> <ul style="list-style-type: none"> - //www.m2mprovider.com /CSE00030F003A/CSE-Building-A3/HVAC-AE/WaterTemp/sample0098 <p>This example is the Absolute</p>	<p>On Mca, Mcc and Mcc' reference points: to refer to resources that are hosted by the CSE in a different M2M Service Provider Domain than the Originator's.</p>

Identifier Name	Absolute & Format-Designator or Relative & Format-Designator & Context	Format	Rule of use
		Resource-ID of a <contentInstance> resource, where the targeted resource is hosted within the domain of the M2M-Service Provider with the M2M-SP-ID "//www.m2mprovider.com" on a CSE with the SP-relative-CSE-ID "/CSE00030F003A" and where the CSE-ID is followed by "/" plus the name "CSE-Building-A3" of the <CSEBase> resource, followed by "/" plus the name "HVAC-AE" of an <AE> child resource, followed by "/" plus the name "WaterTemp" of a <container> child resource, followed by "/" plus the name "sample0098" of the targeted child <contentInstance> resource.	
APP-ID	App-ID	<p>App-ID is either registered with the M2M App-ID Registration Authority or non-registered.</p> <p>Registered App-IDs shall be in the format: R{authority-ID}.{reverseDNS}.{applicationName}</p> <p>The {reverseDNS} part shall be a string value following 'reverse DNS notation', which is constructed in the reverse order of domain name components (see IETF RFC 1035 [i.7])</p> <p>Non-registered App-IDs shall be in the format: N{non-registered-App-ID}</p> <p>Examples:</p> <ul style="list-style-type: none"> - Ra01.com.company.smartcity - Nk836-t071-fc022 	<p>AE Registration Procedure described in clause 10.1.1.2.2.</p> <p>The first character of the App-ID shall be a capital letter of 'R' for registered and 'N' for non-registered.</p>

The format (i.e. CSE-relative, SP-relative or absolute) of resource identifier (e.g. the **To** parameter, *accessControlPolicyIDs* attribute) shall be correctly set by the Originator in an initial request, while the format of AE-ID or CSE-ID in the **From** parameter shall be set in a shortest format by the Originator in the initial request and it shall be converted in another format by the Registrar CSE or IN-CSE as the following.

When an AE is the Originator, the **From** parameter shall be in AE-ID-Stem. When the Registrar CSE receives the request, it shall convert the format into SP-relative AE-ID in case the stem is CSE-relative and the **To** parameter refers to a resource hosted by a different CSE.

When an CSE is the Originator, the **From** parameter shall be in SP-relative CSE-ID.

The IN-CSE shall convert the format of the **From** parameter in a request that is received from SP-relative to absolute if the **To** parameter refers to a resource is hosted by a CSE in a different M2M Service Provider Domain.

1 7.3 M2M Identifiers lifecycle and characteristics

2 Table 7.3-1: M2M Identifiers lifecycle and characteristics

Identifier	Assigned by	Assigned to	Assigned during	Lifetime	Uniqueness	Used during	Remarks
M2M Service Provider Identifier	Out of scope	AE, CSE	Out of scope	Out of scope	Global	Provisioning	
Application Entity Identifier	AE or Registrar CSE	AE	AE start-up	Application Entity Registration	Global	- Application Entity Registration - Security Context Establishment - All other operations initiated by the AE	Security requirements apply for Security Context Establishment
Application Identifier	Out of scope	Out of scope	Pre-provisioned	Out of scope	Specific to M2M service deployment	- Application Entity registration	
CSE Identifier	M2M SP	CSE	Security Provisioning	Life of the CSE	Global	- Information flows (clause 10) - Security Context Establishment	Security requirements apply for Security Context Establishment
M2M Node Identifier	Out of Scope	All M2M Nodes	Pre-provisioned	Life of the M2M Node	Global	- Device Management	Needs to be Read Only
M2M Subscription Identifier	M2M SP, Out of Scope	Application Entities, and one or more CSEs belonging to the same M2M subscriber	At service signup	Life of the M2M Service Subscription with the M2M Service Provider	Global	- Charging and Information Recorded - Role based access control - Authentication	Multiple CSEs can be allocated the same M2M Subscription Identifier
M2M Service Profile Identifier	M2M SP	Every M2M Node	At service signup	Life of M2M Service Subscriptions with the M2M Service Provider	Global for roaming cases otherwise local	Information Flows (clause 10)	The ID has to be pre-provisioned after signup, but may need to be updated during the subscription lifetime due to changes in the subscribed services
M2M-Request-ID	Mcc: CSE Mca: Application Entity	A request initiated by an AE or CSE	Mcc: When a request is initiated by a CSE, or handling of a request received by a CSE. Mca: When a request is initiated by an AE	Equal to the lifetime of the Request and its corresponding Response	Mcc: Global Mca: Local or global	Requests and corresponding responses	

Identifier	Assigned by	Assigned to	Assigned during	Lifetime	Uniqueness	Used during	Remarks
External Identifier	Jointly between the Underlying Network provider and M2M SP.	M2M Node belonging to a CSE that wants to utilize services of the Underlying Network.	Administrative Agreement.	Life of the CSE.	Local or global, decided by the specific Underlying Network provider	Requests initiated by a CSE over the Mcn reference point, where applicable.	<p>Pre-Provisioned Mode: Made available at the Infrastructure Node.</p> <p>Dynamic Mode: Made available at M2M device. Conveyed to IN-CSE during CSE Registration.</p>
Underlying Network Identifier	M2M SP	Underlying Networks	Pre-provisioned	Life of the agreement by the M2M SP with the Underlying Network	Local to M2M SP domain	UL Network selection	
Trigger Recipient Identifier	Execution Environment	ASN/MN-CSE	ASN/MN-CSE start-up or wake-up	Life of the CSE	Execution Environment-wide	Device Triggering procedures, where applicable	<p>Pre-Provisioned Mode: Made available at Infrastructure Node along with M2M-Ext-ID.</p> <p>Dynamic Mode: Made available at M2M device. Conveyed to IN-CSE during CSE Registration along with M2M-Ext-ID.</p>
M2M Service Identifier	M2M Service Provider, Out of Scope	A service defined by the M2M Service Provider which consists of a set of functions defined by the present document.	Out of Scope	Out of Scope	Local to the M2M Service Provider	For M2M Service Subscription	
Role-ID	M2M Service Provider	Application Entities, and one or more CSEs belonging to the same M2M subscriber	Out of scope	Out of scope	Local to M2M SP domain	Access Control Policy	
Token-ID	Token Issuer	Token	Token Assignment	Specified by Token	Global	Dynamic Authorization	
Local-Token-ID	A Hosting CSE making access decisions with the corresponding token	Token	After Hosting CSE has been provided with Token	Specified by Token	Local to the Hosting CSE	Indirect Dynamic Authorization	See clause 11.5.3

8 Description and Flows of Reference Points

8.1 General Communication Flow Scheme on Mca and Mcc Reference Points

8.1.0 Overview

Procedures involving CSEs and AEs are driven by the exchange of messages across reference points according to the message flows described in this clause.

Depending on the message operation, procedures may manipulate information in a standardized resource structure as described in clause 9. Access and manipulation of the resources is subject to their associated privileges.

8.1.1 Description

Figure 8.1.1-1 shows the general flow that governs the information exchange within a procedure, which is based on the use of Request and Response messages. The message applies to communications such as:

- between an AE and a CSE (Mca reference point); and
- among CSEs (Mcc reference point).

Such communications can be initiated either by the AEs or by the CSEs depending upon the operation in the Request message.

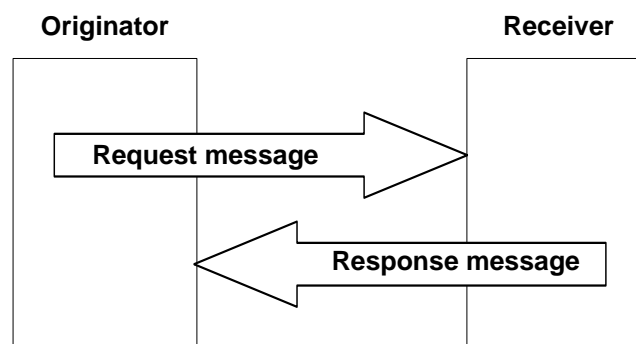

Figure 8.1.1-1: General Flow

8.1.2 Request

Requests over the Mca and Mcc reference points, from an Originator to a Receiver, shall contain mandatory and may contain optional parameters. Certain parameters may be mandatory or optional depending upon the Requested operation. In this clause, the mandatory parameters are detailed first, followed by those that are operation dependent, and then by those that are optional:

- **To:** Address of the target resource or target attribute for the operation. The **To** parameter shall conform to clause 9.3.1.

NOTE 1: **To** parameter can be known either by pre-provisioning (clause 11.2) or by discovery (clause 10.2.6 for discovery). Discovery of <CSEBase> resource is not supported in this release of the document. It is assumed knowledge of <CSEBase> resource is by pre-provisioning only.

NOTE 2: The term target resource refers to the resource which is addressed for the specific operation. For example the **To** parameter of a Create operation for a resource <example> would be "/m2m.provider.com/exampleBase". The **To** parameter for the Retrieve operation of the same resource <example> is "/m2m.provider.com/exampleBase/example".

NOTE 3: For Retrieve operation (clause 10.1.2), the **To** parameter can be the URI of an attribute to be retrieved.

- **From:** Identifier representing the Originator.

The **From** parameter is used by the Receiver to check the Originator identity for access privilege verification.

- **Operation:** operation to be executed: Create (C), Retrieve (R), Update (U), Delete (D), Notify (N).

The **Operation** parameter shall indicate the operation to be executed at the Receiver:

- **Create (C):** **To** is the address of the target resource where the new resource (parent resource).
 - **Retrieve (R):** an existing **To** addressable resource is read and provided back to the Originator.
 - **Update (U):** the content of an existing **To** addressable resource is replaced with the new content as in **Content** parameter. If some attributes in the **Content** parameter do not exist at the target resource, such attributes are created with the assigned values. If some attributes in the **Content** parameter are set to NULL, such attributes are deleted from the addressed resource.
 - **Delete (D):** an existing **To** addressable resource and all its sub-resources are deleted from the Resource storage.
 - **Notify (N):** information to be sent to the Receiver, processing on the Receiver is not indicated by the Originator.
- **Request Identifier:** request Identifier (see clause 7.1.7).

Example usage of request identifier includes enabling the correlation between a Request and one of the many received Responses.

Operation dependent Parameters:

- **Content:** resource content to be transferred.

The **Content** parameter shall be present in Request for the following operations:

- **Create (C):** **Content** is the content of the new resource with the resource type **ResourceType**.
- **Update (U):** **Content** is the content to be replaced in an existing resource. For attributes to be updated at the resource, **Content** includes the names of such attributes with their new values. For attributes to be created at the resource, **Content** includes names of such attributes with their associated values. For attributes to be deleted at the resource, **Content** includes the names of such attributes with their value set to NULL.
- **Notify (N):** **Content** is the notification information.

The **Content** parameter may be present in Request for the following operations:

- **Retrieve (R):** **Content** is the list of attribute names from the resource that needs to be retrieved. The values associated with the attribute names shall be returned.
- **Resource Type:** type of resource.

The **ResourceType** parameter shall be present in Request for the following operations:

- **Create (C):** **Resource Type** is the type of the resource to be created.

Optional Parameters:

- **Role IDs:** optional, required when role based access control is applied. A list of Role-IDs that are allowed by the service subscription shall be provided otherwise the request is considered not valid.

The **Role IDs** parameter shall be used by the Receiver to check the Access Control privileges of the Originator.

- **Originating Timestamp:** optional originating timestamp of when the message was built.

Example usage of the originating timestamp includes: to measure and enable operation (e.g. message logging, correlation, message prioritization/scheduling, accept performance requests, charging, etc.) and to measure performance (distribution and processing latency, closed loop latency, SLAs, analytics, etc.).

- **Request Expiration Timestamp:** optional request message expiration timestamp. The Receiver CSE should handle the request before the time expires. If a Receiver CSE receives a request with **Request Expiration Timestamp** with the value indicating a time in the past, then the request shall be rejected.

Example usage of the request expiration timestamp is to indicate when request messages (including delay-tolerant) should expire and to inform message scheduling/prioritization. When a request with set expiration timestamp demands an operation on a Hosting CSE different than the current Receiver CSE, then the current CSE shall keep trying to deliver the Request to the Hosting CSE until the request expiration timestamp time, in line with provisioned policies.

- **Result Expiration Timestamp:** optional result message expiration timestamp. The Receiver CSE should return the result of the request before the time expires.

Example usage of the result expiration timestamp: An Originator indicates when result messages (including delay-tolerant) should expire and informs message scheduling/prioritization. It can be used to set the maximum allowed total request/result message sequence round trip deadline.

- **Response Type:** optional response message type: Indicates what type of response shall be sent to the issued request and when the response shall be sent to the Originator:

- **nonBlockingRequestSynch:** In case the request is accepted by the Receiver CSE, the Receiver CSE responds, after acceptance, with an Acknowledgement confirming that the Receiver CSE will further process the request. The Receiver CSE includes in the response to an accepted request a reference that can be used to access the status of the request and the result of the requested operation at a later time. Processing of Non-Blocking Requests is defined in clause 8.2.2 and in particular for the synchronous case in clause 8.2.2.2.
- **nonBlockingRequestAsynch {optional list of notification targets}:** In case the request is accepted by the Receiver CSE, the Receiver CSE shall respond, after acceptance, with an Acknowledgement confirming that the Receiver CSE will further process the request. The result of the requested operation needs to be sent as notification(s) to the notification target(s) provided optionally within this parameter as a list of entities or to the Originator when no notification target list is provided. When an empty notification target list is provided by the Originator, no notification with the result of the requested operation shall be sent at all. Processing of Non-Blocking Requests is defined in clause 8.2.2 and in particular for the asynchronous case in clause 8.2.2.3.
- **blockingRequest:** In case the request is accepted by the Receiver CSE, the Receiver CSE responds with the result of the requested operation after completion of the requested operation. Processing of Blocking Requests is defined in clause 8.2.1. This is the default behaviour when the *Response Type* parameter is not given the request.
- **flexBlocking {optional list of notification targets}:** When *Response Type* in the request received by the Receiver CSE is set to flexBlocking, it means that the Originator of the request has the capability to accept the following types of responses: nonBlockingRequestSynch, nonBlockingRequestAsynch and blockingRequest.

The Receiver CSE shall make the decision to respond using blocking or non-blocking based on its own local context (memory, processing capability, etc.) if not defined in the resource handling procedure.

If the Receiver CSE choose to respond using non-blocking mode or blocking mode, based on the presence of notification targets in the request:

- If the notification targets are provided in the request and the Receiver CSE is responding, the Receiver CSE shall choose and respond with nonBlockingRequestAsynch, nonBlockingRequestSynch or blockingRequest mode.
- If notification targets are not provided, the Receiver CSE shall choose and respond with nonBlockingRequestSynch or blockingRequest mode.

Example usage of the response type set to *nonBlockingRequestSynch*: An Originator that is optimized to minimize communication time and energy consumption wants to express a Request to the receiver CSE and get an acknowledgement on whether the Request got accepted. After that the Originator may switch into a less power consuming mode and retrieve a Result of the requested Operation at a later time.

Further example usage of response type set to *nonBlockingRequestSynch*: When the result content is extremely large, or when the result consists of multiple content parts from a target group which are to be aggregated asynchronously over time.

- **Result Content**: optional result content: Indicates what are the expected components of the result of the requested operation. The Originator of a request may not need to get back a result of an operation at all. This shall be indicated in the **Result Content** parameter. Settings of **Result Content** depends on the requested operation specified in **Operation**. Possible values of **Result Content** are:
 - **attributes**: A representation of the targeted resource including all its attributes shall be returned as content, without the address(es) of the child resource(s) or their descendants. For example, if the request is to retrieve a <container> resource, the address(es) of the <contentInstance> child-resource(s) is not provided. This setting shall be only valid for a Create, Retrieve, Update, or Delete operation. If the Originator does not set **Result Content** parameter in a Create, Retrieve and Update request message, this setting shall be the default value when the Receiver processes the request message.
 - **modified-attributes**: This setting shall be only valid for a Create or Update operation. A representation of the targeted resource including only the assigned or modified attributes relative to what was provided by the Originator of the request shall be returned as content, without the address(es) of the child resource(s) or their descendants.
 - **hierarchical-address**: Representation of the address of the created resource. This setting shall only be valid for a Create operation. The address shall be in hierarchical address scheme.
 - **hierarchical-address+attributes**: Representation of the address in hierarchical address scheme and the attributes of the created resource. This setting shall only be valid for a Create operation.
 - **attributes+child-resources**: Representation of the requested resource, along with a nested representation of all of its child resource(s) , and their descendants, in line with any provided filter criteria as given in the **Filter Criteria** parameter shall be returned as content. If there is no filter criteria parameter in the request message then all children/descendants are returned along with their attributes. For example, if the request is to retrieve a <container> resource that only has <contentInstance> children, the attributes of that <container> resource and a representation of all of its <contentInstance> child-resource(s) , including their attributes, are provided.

The originator may request to limit the maximum number of allowed nesting levels. The originator may also include an offset that indicates the starting point of the direct child resource. The offset shall start at 1. The hosting CSE shall return all direct child resources and their descendants, or up to the maximum nesting level specified in a request subject to maximum size limit that may be imposed by the hosting CSE. The offset, maximum number/size and maximum level shall be specified in **Filter Criteria** as *offset*, *limit*, and *level* condition, respectively, by the Originator.

The hosting CSE shall list parent resources before their children. This means that the originator of the request will not receive a discovered resource without having received its parents. The hosting CSE shall also ensure that proper nesting representation of all the children is incorporated in its listing for parents and children.

Nested processing is applicable at every level in the resource tree. If a direct child resource and all its descendants cannot be included in the returned content due to size limitations imposed by the hosting CSE then the direct child resource shall not be included in the response.

An indication shall be included in the response signalling if the returned content is partial. If the indication is for partial content, the response shall include an offset for the direct child resource where processing can restart for the remaining direct child resources.

This shall be only valid for a Retrieve operation.

- **child-resources:** A nested representation of the resource's child resource(s) their descendants and their attributes shall be returned as content. The resources that are returned are subject to any filter criteria that are given in the **Filter Criteria** parameter (if there are no filter criteria then all children and their descendants are returned). The attributes of the parent resource are not returned, but all the attributes of the children are returned. For example, if the request is to retrieve a <container> resource that only has <contentInstance> children, only a representation of all of its <contentInstance> child-resource(s) is provided.

The offset, maximum number/size and maximum level shall be specified in **Filter Criteria** as *offset*, *limit*, and *level* condition, respectively, by the Originator. Processing of direct child resources, size limitations, maximum nesting level, and offset for the starting of direct child resource processing of **the attributes+child-resources** option shall apply to this option as well.

This shall be only valid for a Retrieve operation.

- **attributes+child-resource-references:** Representation of the requested resource, along with the address(es) of the child resource(s), and their descendants shall be returned as content. For example, if the request is to retrieve a <container> resource, the <container> resource and the address(es) of the <contentInstance> child-resource(s) are provided.

The offset, maximum number/size and maximum level shall be specified in **Filter Criteria** as *offset*, *limit*, and *level* condition, respectively, by the Originator. Processing of child resources, size limitations, maximum nesting level, and offset for the starting of child resource processing of **the attributes+child-resources** option shall apply to this option as well.

This shall be only valid for a Retrieve operation.

- **child-resource-references:** Address(es) of the child resources and their descendants, without any representation of the actual requested resource shall be returned as content. For example, if the request is to retrieve a <container> resource, only the address(es) of the <contentInstance> child-resource(s) is provided.

The offset, maximum number/size and maximum level shall be specified in **Filter Criteria** as *offset*, *limit*, and *level* condition, respectively, by the Originator. Processing of child resources, size limitations, maximum nesting level, and offset for the starting of child resource processing of **the attributes+child-resources** option shall apply to this option as well.

This shall be only valid for a Retrieve operation.

This option can be used within the context of resource discovery mechanisms (see clause 10.2.6).

- **nothing:** Nothing shall be returned as operational result content. . If the Originator does not set **Result Content** parameter in a Delete request message, this setting shall be the default value when the Receiver processes the request message. This setting shall be valid for a Create, Update, Delete, or Notify operation.

EXAMPLE: If the request is to delete a resource, this setting indicates that the response shall not include any content.

- **original-resource:** Representation of the original resource pointed by the *link* attribute in the announced resource shall be returned as content, without the address(es) of the child resource(s). This shall be only valid for a Retrieve operation where the **To** parameter targets the announced resource.

Note that for any of the above options, Discovery access control is applied against discovery related procedures, while Retrieve access control procedures is applied against non-discovery related Retrieve operations.

Note that the filter criteria usage governs the purpose of a Retrieve operation.

Table 8.1.2-1: Summary of Result Content Values

Value	Create	Retrieve	Update	Delete	Notify
attributes	default	default	default	valid	n/a
modified-attributes	valid	n/a	valid	n/a	n/a
hierarchical-address	valid	n/a	n/a	n/a	n/a
hierarchical-address+attributes	valid	n/a	n/a	n/a	n/a
attributes+child-resources	n/a	valid	n/a	n/a	n/a
child-resources	n/a	valid	n/a	n/a	n/a
attributes+child-resource-references	n/a	valid	n/a	n/a	n/a
child-resource-references	n/a	valid	n/a	n/a	n/a
nothing	valid	n/a	valid	default	valid
original-resource	n/a	valid	n/a	n/a	n/a

- **Result Persistence:** optional result persistence: indicates the time for which the response may persist to. The parameter is used in case of non-blocking request where the result attribute of the <request> resource should be kept at the CSE, for example, with the purpose of sharing, tracking and analytics.

In the case the response of a request is required to be kept in the CSE, for example the procedures of <request> resource, <delivery> resource and <group> resource, the **Result Persistence** indicates the time duration for which the CSE keeps the response available after receiving it.

Example usage of result persistence includes requesting sufficient persistence for analytics to process the response content aggregated asynchronously over time. If a result expiration time is specified then the result persistence lasts beyond the result expiration time.

- **Operation Execution Time:** optional operation execution time: indicates the time when the specified operation **Operation** is to be executed by the target CSE. A target CSE shall execute the specified operation of a Request having its operational execution time indicator set, starting at the operational execution time. If the execution time has already passed or if the indicator is not set, then the specified operation shall be immediately executed, unless the request expiration time, if set, has been reached.

Example usage of operational execution time includes asynchronous distribution of flows, which are to be executed synchronously at the operational execution time.

NOTE 4: Time-based flows could not supported depending upon time services available at CSEs.

- **Event Category:** optional event category: Indicates the event category that should be used to handle this request. Event categories are impacting how Requests to access remotely hosted resources are processed in the CMDH CSF. Selection and scheduling of connections via CMDH are driven by policies that can differentiate event categories.

Example usage of "event category" set to specific value X: When the request is demanding an operation to be executed on a Hosting CSE that is different from the current Receiver CSE, the request may be stored in the current Receiver CSE that is currently processing the request on the way to the Hosting CSE until it is allowed by provisioned policies for that event category X to use a communication link to reach the next CSE on a path to the Hosting CSE or until the request expiration timestamp is expired.

The following values for **Event Category** shall have a specified pre-defined meaning:

- **Event Category = immediate:** Requests of this category shall be sent as soon as possible and shall not be subject to any further CMDH processing, i.e. the request will not be subject to storing in CMDH buffers when communication over an underlying network is possible. In particular, CMDH processing will respect values for **Request Expiration Timestamp**, **Result Expiration Timestamp** given in the original request and not fill in any default values if they are missing.
- **Event Category = bestEffort:** Requests of this category can be stored in CMDH buffers at the discretion of the CSE that is processing the request for an arbitrary time and shall be forwarded via Mcc on a best effort basis. The CSE does not assume any responsibility to meet any time limits for delivering the information to the next CSE. Also the maximum amount of buffered requests for this category is at the discretion of the processing CSE.

- **Event Category = latest:**
 - If this category is used in a request asking for a CRUD operation on a resource, the following shall apply:
 - CRUD requests using this category shall undergo normal CMDH processing as outlined further below in the present document and in oneM2M TS-0004 [3] with a maximum buffer size of one pending request for a specific pair of **From** and **To** parameters that appear in the request. If a new request message is received by the CSE with a pair of parameters **From** and **To** that has already been buffered for a pending request, the newer request will replace the buffered older request.
 - If this category is used in a notification request triggered by a subscription, the following shall apply:
 - Notification requests triggered by a subscription using this category shall undergo normal CMDH processing as outlined further below in the present document and in oneM2M TS-0004 [3] with a maximum buffer size of one pending notification request per subscription reference that appears in a notification request. If a new notification request is received by the CSE with a subscription reference that has already been buffered for a pending notification request, the newer request will replace the buffered older request.
 - If no further CMDH policies are provisioned for this event category, the forwarding process shall follow the 'bestEffort' rules defined above.

The M2M Service Provider shall be able to provision CMDH policies describing details for the usage of the specific Underlying Network(s) and the applicable rules as defined in the [*cmdhPolicy*] resource type for other **Event Category** values not listed above.

- **Delivery Aggregation:** optional delivery aggregation on/off: Use CRUD operations of <delivery> resources to express forwarding of one or more original requests to the same target CSE(s). When this parameter is not given in the request, the default behaviour is determined per the provisioned CMDH policy if available. If there is no such CMDH policy, then the default value is "aggregation off".

NOTE 5: Since **Delivery Aggregation** is optional, there could be a default value to be used when not present in the Request. This parameter could not be exposed to AEs via Mca.

Example usage of delivery aggregation set on: The CSE processing a request shall use aggregation of requests to the same target CSE by requesting CREATE of a <delivery> resource on the next CSE on the path to the target CSE.

- **Group Request Identifier:** optional group request identifier: Identifier optionally added to the group request that is to be fanned out to each member of the group in order to detect loops and avoid duplicated handling of operation in case of loops of group and common members between groups that have parent-child relationship.
- **Filter Criteria:** optional filter criteria: conditions for filtered retrieve operation are described in table 8.1.2-2. This is used for resource discovery (clause 10.2.6) and general retrieve, update, delete requests (clauses 10.1.2, 10.1.3 and 10.1.4).

Example usage of retrieve requests with filter criteria using *modifiedSince* condition tag: if a target resource is modified since 12:00 then the Hosting CSE will send a resource representation.

- **Discovery Result Type:** Optional Discovery result format. This parameter applies to discovery related requests (see *filterUsage* in table 8.1.2-2 and clause 10.2.6) to indicate the preference of the Originator for the format of returned information in the result of the operation. This parameter shall take on one of the following values reflecting the options in clause 9.3.1:
 - *Hierarchical addressing* method.
 - *Non-hierarchical addressing* method.

For example if **Discovery Result Type** is set to *Non-hierarchical* addressing method, then the request Originator indicates that the discovered resources should be in the form of *Non-hierarchical* address.

The absence of the parameter implies that the result shall be in the form of a *Hierarchical* address.

- **Token Request Indicator:** Optional parameter used to indicate that the Originator supports the Token Request procedure, and the Originator may attempt the Token Request procedure if the Receiver provides a **Token Request Information** parameter in the response.
- **Tokens:** Optional parameter used to transport ESData-protected **Tokens** applicable to the request for use in Indirect Dynamic Authorization.
- **Token IDs:** Optional parameter used to transport **Token-IDs** applicable to the request for use in Indirect Dynamic Authorization.
- **Local Token IDs:** Optional parameter used to transport Local-Token-IDs applicable to the request for use in Indirect Dynamic Authorization.
- **Release Version Indicator:** This parameter is used to indicate the oneM2M release version that this request message conforms to. Starting with Release 2 this parameter is mandatory. The release version indicated shall apply to all oneM2M defined request parameters and certain types of content carried in the **Content** request parameter. Within the **Content** request parameter, the release version indicated shall apply to all oneM2M defined elements (e.g. notifications) and resource types with the exception of *<flexContainer>* specializations which have their own version implicitly defined by their respective *containerDefinition* attribute. In addition, the release version indicated does not apply to resource types or specializations defined external to oneM2M.
- **Vendor Information:** This optional parameter is available to convey vendor specific information. The use of this parameter is not defined by oneM2M specifications.

Table 8.1.2-2: Filter Criteria conditions

Condition tag	Multiplicity	Matching condition
<i>createdBefore</i>	0..1	The <i>creationTime</i> attribute of the resource is chronologically before the specified value.
<i>createdAfter</i>	0..1	The <i>creationTime</i> attribute of the resource is chronologically after the specified value.
<i>modifiedSince</i>	0..1	The <i>lastModifiedTime</i> attribute of the resource is chronologically after the specified value.
<i>unmodifiedSince</i>	0..1	The <i>lastModifiedTime</i> attribute of the resource is chronologically before the specified value.
<i>stateTagSmaller</i>	0..1	The <i>stateTag</i> attribute of the resource is smaller than the specified value.
<i>stateTagBigger</i>	0..1	The <i>stateTag</i> attribute of the resource is bigger than the specified value.
<i>expireBefore</i>	0..1	The <i>expirationTime</i> attribute of the resource is chronologically before the specified value.
<i>expireAfter</i>	0..1	The <i>expirationTime</i> attribute of the resource is chronologically after the specified value.
<i>labels</i>	0..1	The <i>labels</i> attributes of the resource matches the specified value.
<i>resourceType</i>	0..n	The <i>resourceType</i> attribute of the resource is the same as the specified value. It also allows differentiating between normal and announced resources.
<i>sizeAbove</i>	0..1	The <i>contentSize</i> attribute of the <i><contentInstance></i> resource is equal to or greater than the specified value.
<i>sizeBelow</i>	0..1	The <i>contentSize</i> attribute of the <i><contentInstance></i> resource is smaller than the specified value.
<i>contentType</i>	0..n	The <i>contentInfo</i> attribute of the <i><contentInstance></i> resource matches the specified value.
<i>limit</i>	0..1	The maximum number of resources to be returned in the response. This may be modified by the Hosting CSE. When it is modified, then the new value shall be smaller than the suggested value by the Originator.
<i>attribute</i>	0..n	This is an attribute of resource types (clause 9.6). Therefore, a real tag name is variable and depends on its usage and the value of the attribute can have wild card *. E.g. <i>creator</i> of container resource type can be used as a filter criteria tag as "creator=Sam" , "creator=Sam*" , "creator=*Sam" .

Condition tag	Multiplicity	Matching condition
<i>filterUsage</i>	0..1	Indicates how the filter criteria is used. If provided, possible values are 'discovery' and 'IPEOnDemandDiscovery'. If this parameter is not provided, the Retrieve operation is a generic retrieve operation and the content of the child resources fitting the filter criteria is returned. If filterUsage is 'discovery', the Retrieve operation is for resource discovery (clause 10.2.6), i.e. only the addresses of the child resources are returned. If filterUsage is 'IPEOnDemandDiscovery', the other filter conditions are sent to the IPE as well as the discovery Originator ID. When the IPE successfully generates new resources matching with the conditions, then the resource address(es) shall be returned. This value shall only be valid for the Retrieve request targeting an <AE> resource that represents the IPE.
<i>semanticsFilter</i>	0..n	The semantic description contained in one of the <semanticDescriptor> child resources matches the semanticFilter that shall be specified in the SPARQL query language [5]. Examples for matching semantic filters in SPARQL to semantic descriptions can be found in [i.28].
<i>filterOperation</i>	0..1	Indicates the logical operation (AND/OR) to be used for different condition tags. The default value is logical AND.
<i>contentFilterSyntax</i>	0..1	Indicates the Identifier for syntax to be applied for content-based discovery.
<i>contentFilterQuery</i>	0..1	The query string shall be specified when <i>contentFilterSyntax</i> parameter is present.
<i>level</i>	0..1	The maximum level of resource tree that the Hosting CSE shall perform the operation starting from the target resource (i.e. To parameter). This shall only be applied for Retrieve operation. The level of the target resource itself is zero and the level of the direct children of the target is one.
<i>offset</i>	0..1	The number of direct child and descendant resources that a Hosting CSE shall skip over and not include within a Retrieve response when processing a Retrieve request to a targeted resource.

The rules when multiple conditions are used together shall be as follows:

- Different condition tags shall use the "AND/OR" logical operation based on the *filterOperation* specified;
e.g. *createdBefore* = "time1" AND *unmodifiedSince* = "time2" if *filterOperation* = "AND" or "NULL", or
createdBefore = "time1" OR *unmodifiedSince* = "time2" if *filterOperation* = "OR".
- Same condition tags shall use the "OR" logical operation, i.e. *filterOperation* doesn't apply to same conditions.

No mixed AND/OR filter operation will be supported.

Once the Request is delivered, the Receiver shall analyse the Request to determine the target resource.

If the target resource is addressing another M2M Node, the Receiver shall route the request appropriately.

If the target resource is addressing the Receiver, it shall:

- Check the existence of **To** addressed resource.
- Identify the resource type by **Resource Type**.
- Check the privileges for **From** Originator to perform the requested operation.
- Perform the requested operation (using **Content** content when provided) according to the provided request parameters as described above.
- Depending on the request result content, respond to the Originator with indication of successful or unsuccessful operation results. In some specific cases (e.g. limitation in the binding protocol or based on application indications), the Response could be avoided.

Table 8.1.2-3 summarizes the parameters specified in this clause for the Request message, showing any differences as applied to C, R, U, D or N operations. "M" indicates mandatory, "O" indicates optional, "N/A" indicates "not applicable".

Table 8.1.2-3: Summary of Request Message Parameters

Request message parameter		Operation				
		Create	Retrieve	Update	Delete	Notify
Mandatory	Operation - operation to be executed	M	M	M	M	M
	To - the address of the target resource on the target CSE	M	M	M	M	M
	From - the identifier of the message Originator	O See note 1	M	M	M	M
	Request Identifier - uniquely identifies a Request message	M	M	M	M	M
Operation dependent Optional	Content - to be transferred	M	O	M	N/A	M
	Resource Type - of resource to be created	M	N/A	N/A	N/A	N/A
	Originating Timestamp - when the message was built	O	O	O	O	O
	Request Expiration Timestamp - when the request message expires	O	O	O	O	O
	Result Expiration Timestamp - when the result message expires	O	O	O	O	O
	Operational Execution Time - the time when the specified operation is to be executed by the target CSE	O	O	O	O	O
	Response Type - type of response that shall be sent to the Originator	O	O	O	O	O
	Result Persistence - the duration for which the reference containing the responses is to persist	O	O	O	O	N/A
	Result Content - the expected components of the result	O	O	O	O	N/A
	Event Category - indicates how and when the system should deliver the message	O	O	O	O	O
	Delivery Aggregation - aggregation of requests to the same target CSE is to be used	O	O	O	O	O
	Group Request Identifier - Identifier added to the group request that is to be fanned out to each member of the group	O	O	O	O	O
	Filter Criteria - conditions for filtered retrieve operation	N/A	O	O	O	N/A
	Discovery Result Type - format of information returned for Discovery operation	N/A	O	N/A	N/A	N/A
	Token Request Indicator - indicating that the Originator may attempt Token Request procedure (for Dynamic Authorization) if initiated by the Receiver	O	O	O	O	O
	Tokens - for use in dynamic authorization	O	O	O	O	O
	Token IDs - for use in dynamic authorization	O	O	O	O	O
	Role IDs - for use in role based access control	O	O	O	O	O
Local Token IDs - for use in dynamic authorization	O	O	O	O	O	

Request message parameter		Operation				
		Create	Retrieve	Update	Delete	Notify
Release Version Indicator - the oneM2M release version that this request message conforms to.		M See note 2	M See note 2	M See note 2	M See note 2	M See note 2
Vendor Information		O	O	O	O	O

NOTE 1: *From* parameter is optional in case of an AE CREATE request and mandatory for all other requests.
NOTE 2: **Release Version Indicator** parameter is not present for the case when a request is targeting a Rel-1 entity and mandatory for all other cases.

8.1.3 Response

The Response received by the Originator of a Request accessing resources over the Mca and Mcc reference points shall contain mandatory and may contain optional parameters. Certain parameters may be mandatory or optional depending upon the Requested operation (CRUDN) or the mandatory response code. In this clause, the mandatory parameters are detailed first, followed by those that are conditional, and then by those that are optional.

Mandatory Parameters:

- **Response Status Code:** response status code: This parameter indicates that a result of the requested operation is successful, unsuccessful, acknowledgement or status of processing such as authorization timeout, etc.:
 - A **successful** code indicates to the Originator that the Requested operation has been executed successfully by the Hosting CSE.
 - An **unsuccessful** code indicates to the Originator that the Requested operation has not been executed successfully by the Hosting CSE.
 - An **acknowledgement** indicates to the Originator that the Request has been received and accepted by the attached CSE, i.e. by the CSE that received the Request from the issuing Originator directly, but the Request operation has not been executed yet. The success or failure of the execution of the Requested operation is to be conveyed later.

Details of successful, unsuccessful and acknowledge codes are provided in clause 6.6 of oneM2M TS-0004 [3].

- **Request Identifier:** Request Identifier. The **Request Identifier** in the Response shall match the **Request Identifier** in the corresponding Request.

Conditional Parameters:

- **Content:** resource content:
 - If **Response Status Code** is *successful* then:

The **Content** response parameter may be present in a Create/Update/Delete Response and the information in this **Content** response parameter depends on the value of the **Result Content** request parameter of the corresponding Request. If the value of the **Result Content** request parameter is "nothing" or if the **Result Content** request parameter is not present in a Delete Request, the **Content** response parameter shall not be present. Otherwise, the **Content** response parameter shall be present.

The **Content** parameter shall be present in a Retrieve Response and the information in this **Content** parameter depends on the **Result Content** value of the corresponding Retrieve Request.
 - If **Response Status Code** is *unsuccessful* then the **Content** parameter may be present in a Response to provide more error information.
 - If **Response Status Code** is *acknowledgment* then the **Content** parameter:
 - Shall contain the address of a <request> resource if the response was an acknowledgement of a non-blocking request and the <request> resource type is supported by the Receiver CSE.
 - Is not present otherwise.

- **Content Status:** This parameter shall be present in the response to a Retrieve operation when the returned content is partial. More specifically, this parameter takes the value of partial depending on the **Content** parameter:

- If **Response Code** is *successful* then and the **Content** parameter is present due to the following case:
 - **Retrieve (R): Content** is the retrieved resource content or aggregated contents of discovered resources and the retrieved content is partial.

Then **Content Status** parameter shall be present in the response for a **Retrieve (R)** operation.

- **Content Offset:** This parameter includes the point where a Hosting CSE left off with processing a Retrieve operation that resulted in a response with partial content (i.e. due to reaching the limit on the number of resources allowed in a response). This parameter shall be expressed as a number which can be used in a subsequent Retrieve request. The parameter shall be used by the Hosting CSE to skip over the specified number of direct child and descendant resources of a targeted resource and retrieve the remaining direct child and descendant resources. Its value depends on the information included in the **Content Status** parameter:
 - If **Content Status** parameter is complete then this parameter shall not be included.
 - If **Content Status** parameter is partial then this shall include the offset where processing can restart for the remaining descendant resources in the resource tree.

Then **Content Offset** parameter shall be present in the response for a **Retrieve (R)** operation.

Optional parameters:

- **To:** ID of the Originator or the Transit CSE.
- **From:** ID of the Receiver.

The **To** and **From** parameters can be used in the response for specific protocol bindings (e.g. MQTT):

- **Originating Timestamp:** originating timestamp of when the message was built.
- **Result Expiration Timestamp:** result expiration timestamp. The Receiver shall echo the result expiration timestamp if set in the Request message, or may set the result expiration timestamp itself.

Example usage of the Receiver setting the result expiration timestamp is when the value of the delivery time is dependent upon some changing Receiver context e.g. Result message deadline for aircraft position based upon velocity.

- **Event Category:** event category: Indicates the event category that should be used to handle this response. The definition of event category is the same as in the case of requests in clause 8.1.2.

Example usage of "event category" set to specific value X: When the response is targeted to an entity that is different from the Transit CSE currently processing the response message and is not an AE registered with the Transit CSE that is currently processing the response message, the response may be stored in the Transit CSE that is currently processing the response on the way to the destination of the response message until it is allowed by provisioned policies for that event category X to use a communication link to reach the next CSE on a path to the destination of the response message or until the result expiration timestamp is expired.

- **Token Request Information:** Optional parameter which may be used for requesting Tokens from Dynamic Authorization Systems.
- **Assigned Token Identifiers:** Optional parameter containing the mapping from assigned Local-Token-IDs to corresponding Token-IDs.
- **Release Version Indicator:** This parameter is used to indicate the oneM2M release version that this response message is compliant with. Starting with Release 2 this parameter is mandatory. The release version indicated shall apply to all oneM2M defined response parameters and certain types of content carried in the **Content** response parameter. Within the **Content** response parameter, the release version indicated shall apply to all oneM2M defined elements (e.g. notifications) and resource types with the exception of *<flexContainer>* and *<mgmtObj>* specializations which have their own version implicitly defined by their respective *containerDefinition* and *mgmtSchema* attributes. The release version indicated does not apply to resource types or specializations defined external to oneM2M.
- **Vendor Information:** This optional parameter is available to convey vendor specific information. The use of this parameter is not defined by oneM2M specifications.

Table 8.1.3-1 summarizes the parameters specified in this clause for the Response messages, showing any differences as applied to successful C, R, U, D or N operations, and unsuccessful operations. "M" indicates mandatory, "O" indicates optional, "N/A" indicates "not applicable".

Table 8.1.3-1: Summary of Response Message Parameters

Response message parameter/success or not	Ack	Successful Operation					Unsuccessful Operation	
		Create	Retrieve	Update	Delete	Notify	Create / Retrieve / Update / Delete	Notify
Response Status Code - successful, unsuccessful, ack	M	M	M	M	M	M	M	M
Request Identifier - uniquely identifies a Request message	M	M	M	M	M	M	M	M
Content - to be transferred	O (address of <request> resource if response is ACK of a non-blocking request)	O (The address and/or the content of the created resource)	M (the retrieved resource content or aggregated contents or an address list)	O (The content replaced in an existing resource. The content of the new attributes created. The name of the attributes deleted.)	O (The content actually deleted)	O (see note, end-to-end security protocol message)	O (Additional error info)	O (see note, additional error info secured using ESPrim)
To - the identifier of the Originator or the Transit CSE that sent the corresponding non-blocking request	O	O	O	O	O	O	O	O
From - the identifier of the Receiver	O	O	O	O	O	O	O	O
Originating Timestamp - when the message was built	O	O	O	O	O	O	O	O
Result Expiration Timestamp - when the message expires	O	O	O	O	O	O (see note 1)	O	O (see note 1)
Event Category - what event category shall be used for the response message	O	O	O	O	O	O	O	O
Content Status	N/A	N/A	O	N/A	N/A	N/A	N/A	N/A
Content Offset	N/A	N/A	O	N/A	N/A	N/A	N/A	N/A
Token Request Information	N/A	N/A	N/A	N/A	N/A	N/A	O	O
Assigned Token Identifiers	N/A	O	O	O	O	O	O	O
Release Version Indicator - the oneM2M release version that this response message conforms to	M See note 2	M See note 2	M See note 2	M See note 2	M See note 2	M See note 2	M See note 2	M See note 2
Vendor Information	O	O	O	O	O	O	O	O

NOTE 1: This parameter is present if the response contains an end-to-end security protocol message. Otherwise this parameter is not applicable.

NOTE 2: **Release Version Indicator** parameter is not present for the case when a response is targeting a Rel-1 entity and mandatory for all other cases.

8.2 Procedures for Accessing Resources

8.2.0 Overview

This clause describes the procedures for accessing the resources. The term "hop" in the descriptions here refers to the number of Transit CSEs traversed by a request on its route from the Originator to the Hosting CSE. Traversal implies that the request was forwarded from one CSE to either its Registrar CSE or Registree CSE. For example, when a CSE initiated a request and the Hosting CSE is its Registrar CSE, the hop count is zero.

The Receiver CSE shall forward the received request in the following case:

- The *To* parameter in the request contains a CSE-ID and it does not represent the ID of the Receiver CSE.

The Receiver CSE shall handle the received request in the following cases:

- The *To* parameter in the request contains a CSE-ID and it represents the ID of the Receiver CSE.
- The *To* parameter in the request does not contain a CSE-ID.

All the descriptions and message flows in this clause are illustrative for the direction from a Registree acting as an Originator to a Registrar acting as a Receiver only. The flows from a Registrar CSE to a Registree CSE are symmetric with respect to the one described in this clause. Both the IN-CSE and MN-CSE have the ability to route a received request or response messages to one of their Registrees. If the Hosting CSE is not known by an MN-CSE that receives a request or response message, that MN-CSE shall forward the message to its own Registrar CSE by default.

8.2.1 Accessing Resources in CSEs - Blocking Requests

8.2.1.0 Overview

For the procedures described herein, the addressed resource can be stored in different CSEs. Table 8.2.1.0-1 describes the possible scenarios, where the addressed resource may be on the Registrar CSE or on a CSE located elsewhere in the oneM2M System.

In this clause - for simplicity - it is assumed that the Originator of a Request can always wait long enough to get a Response to the Request after the requested operation has finished. This implies potentially long or unknown blocking times (time for which a pending Request has not been responded to) for the Originator of a Request.

For scenarios that avoid such possibly long blocking times, clause 8.2.2 specifies mechanisms to handle synchronous and asynchronous resource access procedures via returning appropriate references.

Table 8.2.1.0-1: Accessing Resources in different CSEs, from Registree to Registrar CSE

Number of Transit CSEs	Description	Reference
No Hops	<ul style="list-style-type: none"> • The Originator of the Request accesses a resource. • The Originator of the Request can be an AE or a CSE. • Registrar CSE and Hosting CSE are the same entity. • The Hosting CSE checks the Access Control Privileges for accessing the resource. • Depending on the expected result content, the Hosting CSE responds to the Originator of the Request, either with a success or failure Response. 	Figure 8.2.1.0-1
1 Hop	<ul style="list-style-type: none"> • The Originator of the Request accesses a resource. • The Originator of the Request may be an AE or a CSE. • Registrar CSE and hosting CSEs are different entities. • Registrar CSE forwards the Request to the Hosting CSE if the Registrar CSE is registered with the Hosting CSE, for accessing the resource. • Hosting CSE checks the Access Control Privileges for accessing the resource and depending on the expected result content respond with a success or failure Response. 	Figure 8.2.1.0-2
Multi Hops	<ul style="list-style-type: none"> • The Originator of the Request accesses a resource. • The Originator of the Request may be an AE or a CSE. • Registrar CSE, Transit CSE(s) and the Hosting CSE are different entities. • Registrar CSE: <ul style="list-style-type: none"> - forwards the Request to a Transit-1 CSE (e.g. MN-CSE) that the Registrar CSE is registered with, if configured through policies to do so; or - forwards the request to an IN-CSE if the Registrar CSE is registered with IN-CSE and if configured through policies to do so. • Transit-N CSE: <ul style="list-style-type: none"> - forwards the request to the Hosting CSE if it is registered with the Hosting CSE; or - forwards the Request to another Transit-(N+1) CSE (e.g. another MN-CSE) that the Transit-N CSE is registered with; or - forwards the request to an IN-CSE if the Transit-N CSE is registered with the IN-CSE. • In case the Request reaches the IN-CSE, the IN-CSE: <ul style="list-style-type: none"> - performs the processing defined under 'Hosting CSE' below if the targeted resource is hosted on IN-CSE; - forwards the request to another IN-CSE if the resource belongs to another M2M SP; or - forwards the request to the Hosting CSE if the latter is known (e.g. announcements) by the IN-CSE. • Hosting CSE checks the Access Control Privileges for accessing the resource and depending on the expected result content respond with a success or failure Response. 	Figure 8.2.1.0-3

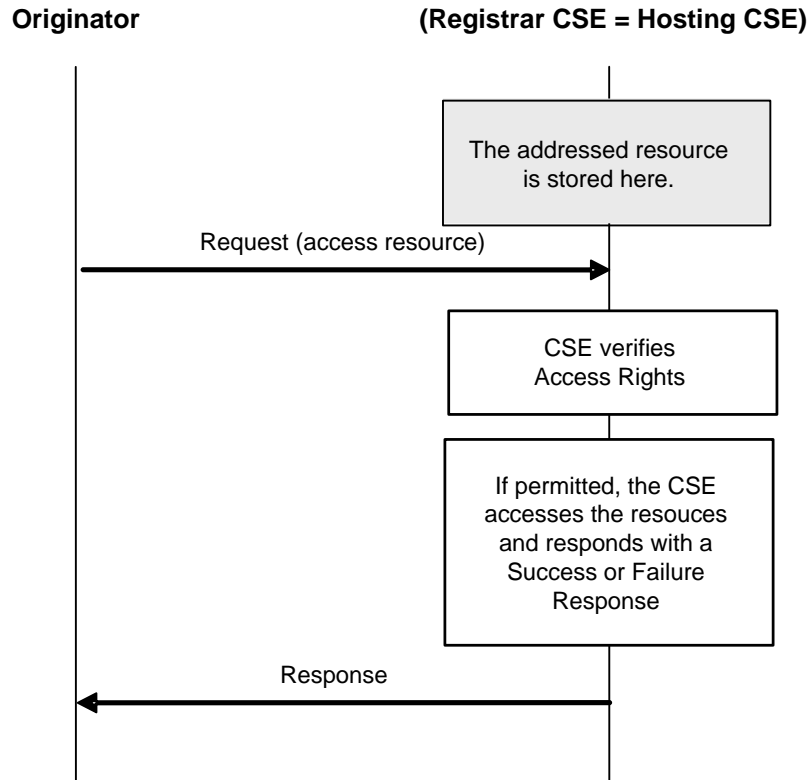

Figure 8.2.1.0-1: Originator accesses a resource on the Registrar CSE (No Hops)

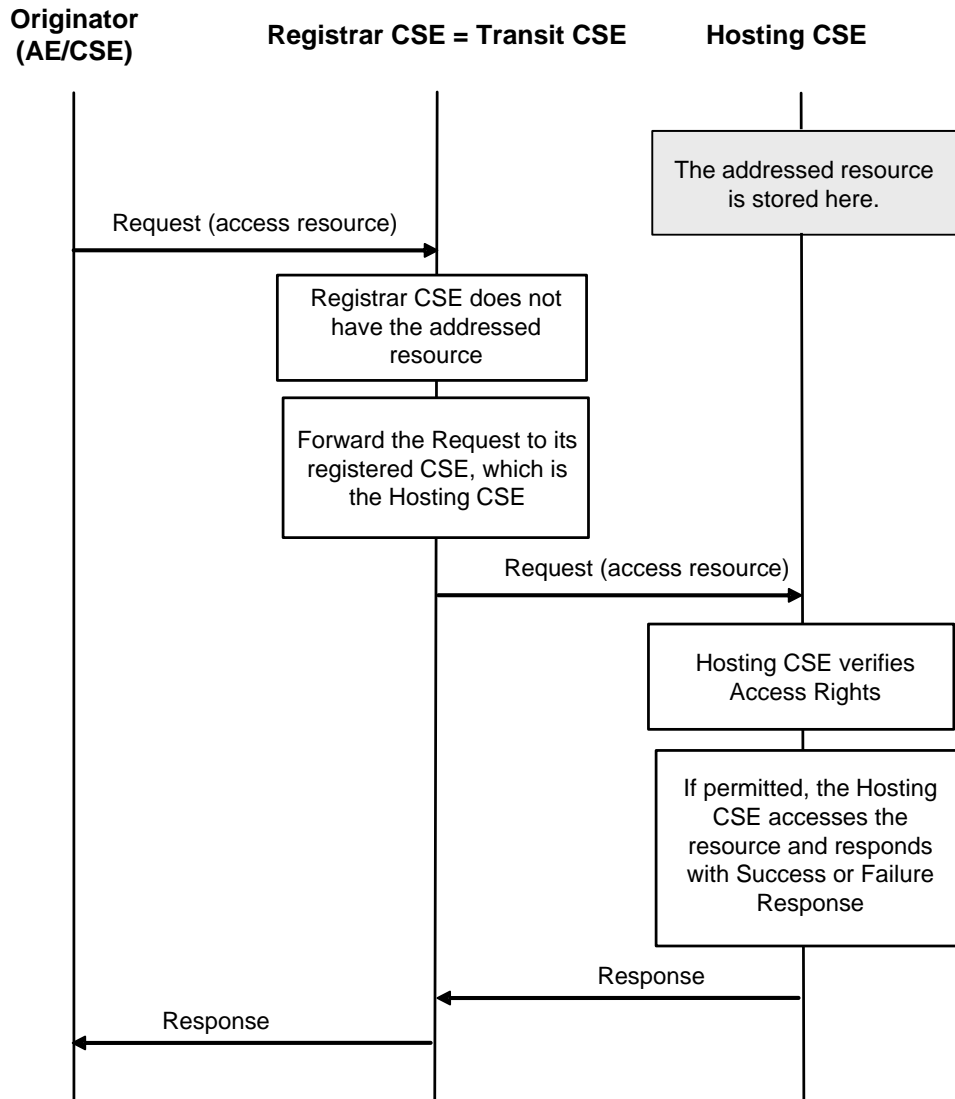

Figure 8.2.1.0-2: AE/CSE accesses a resource at the Hosting CSE (One Hop)

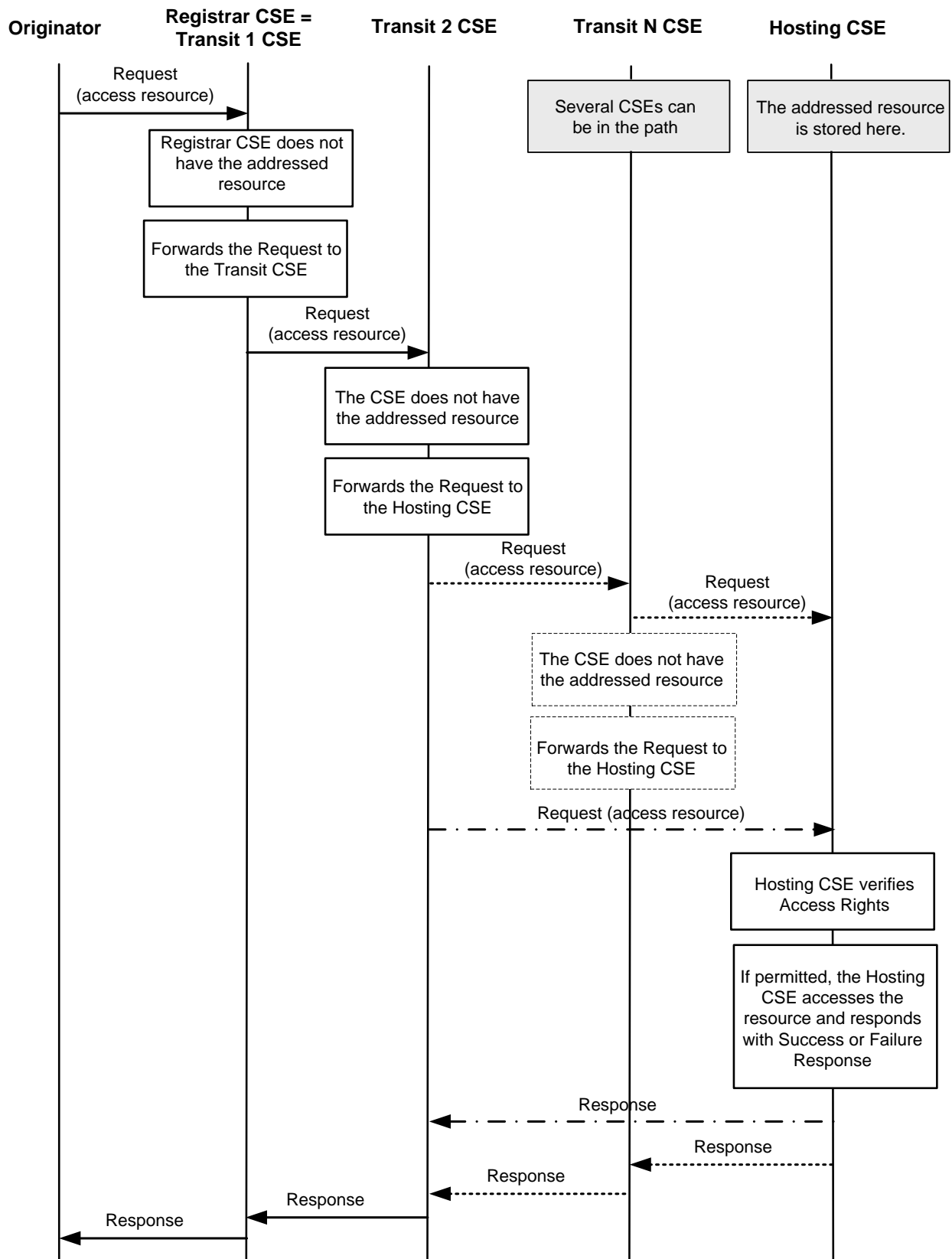

Figure 8.2.1.0-3: Originator accesses a resource at the Hosting CSE (Multi Hops)

8.2.1.1 M2M Requests Routing Policies

CSEs can use policies to govern routing of M2M requests to the next hop towards its target. Routing, through these policies, can be based, for example, on the target CSE, target M2M domain, specific types of resources if applicable, priority of a request, etc.

These policies are not defined in this release of the present document. It is the responsibility of M2M SP and the CSE administrator to ensure the appropriateness of these policies for routing purposes.

8.2.2 Accessing Resources in CSEs - Non-Blocking Requests

8.2.2.1 Response with Acknowledgement and optional Reference to Request Context and Capturing Result of Requested Operation

In case the Originator of a Request has asked for only a response with an Acknowledgement indicating acceptance of the Request and an optional reference to the context where the result of the requested operation is expected - i.e. when the **Response Type** parameter of the request as defined in clause 8.1.2 is set to *nonBlockingRequestSynch* or to *nonBlockingRequestAsynch* - it is necessary to provide a prompt response to the Originator with an Acknowledgement - and in case the *<request>* resource type is supported by the Receiver CSE also, with a reference to an internal resource on the Receiver CSE, so that the Originator can retrieve the status of the request and the outcome of the requested operation at a later time. The details of such an internal resource are defined in clause 9.6.12. In case the *<request>* resource type is supported, the reference is provided in the response to the Request within the **Content** parameter of the Response. The abbreviation "Req-Ref" is used for simplicity in the figures of the following clauses.

Two different cases to allow the Originator of a non-blocking request to retrieve the result of a requested operation are defined in the following two clauses.

8.2.2.2 Synchronous Case

In the synchronous case, it is assumed that the Originator of a Request is not able to receive asynchronous messages, i.e. all exchange of information between Originator and Receiver CSE needs to be initiated by the Originator.

In the synchronous case, a Receiver CSE that does not support the *<request>* resource type shall respond an error indicating that is not supported.

In that case the information flow depicted in figure 8.2.2.2-1 is applicable. For the flow depicted in figure 8.2.2.2-1 it is assumed that completion of the requested operation happens before the Originator is trying to retrieve the result of the requested operation with a second Request referring to the "Req-Ref" provided in the Response to the original Request.

Another variation of the information flow for the synchronous case is depicted in figure 8.2.2.2-2. In this variation it is assumed that the requested operation completes after the second request but before the third request sent by the Originator.

Equivalent information flows are valid also for cases where the target resource of the requested operation is not hosted on the Receiver CSE. From an Originator's perspective there is no difference as the later retrieval of the result of a requested operation would always be an exchange of Request/Response messages between the Originator and the Receiver CSE using the reference to the original request.

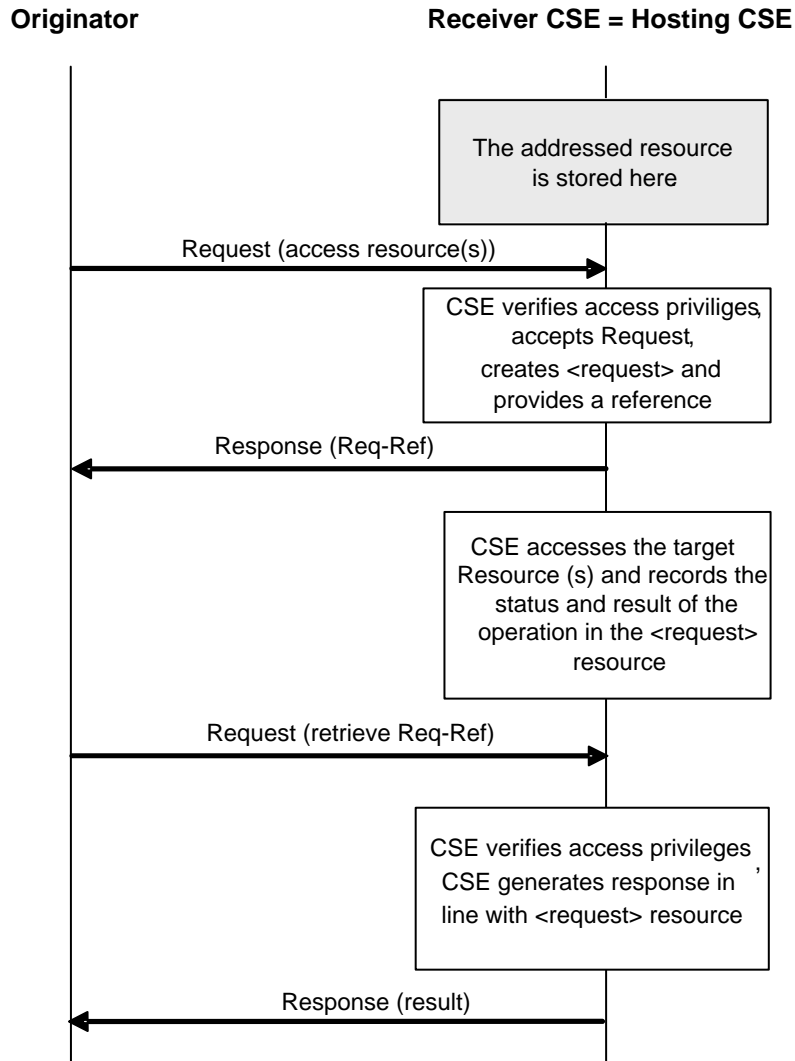

Figure 8.2.2.2-1: Non-blocking access to resource in synchronous mode (Hosting CSE = Receiver CSE), requested operation completed before second request

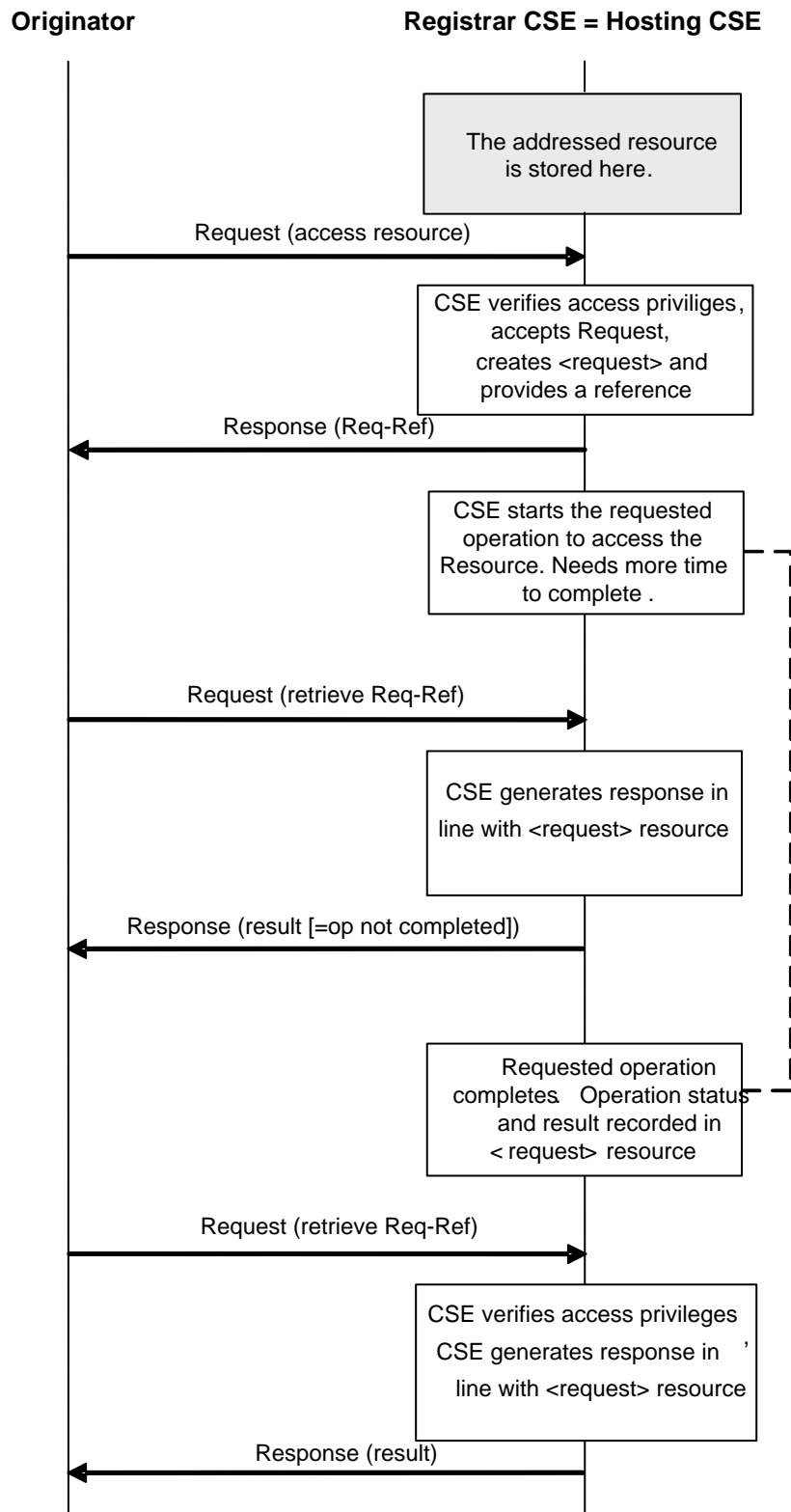

Figure 8.2.2.2-2: Non-blocking access to resource in synchronous mode (Hosting CSE = Receiver CSE), requested operation completed after the second but before the third request

8.2.2.3 Asynchronous Case

In the asynchronous case, it is assumed that the Originator or other entities that need to know about the outcome of a Request are able to receive notification messages, i.e. the CSE carrying out the requested operation may send an unsolicited message to the Originator or to other indicated entities at an arbitrary time to send the status and result of the requested operation to one or more Notification Target(s).

If the Receiver CSE selects to send the NOTIFY in non-blocking asynchronous mode, then the Hosting CSE shall request NOTIFY with ***Response Type*** parameter indicating non-blocking asynchronous operation with empty target list.

In the asynchronous case, a Receiver CSE that does not support the *<request>* resource type shall respond to an acceptable request with a response containing an Acknowledgement without a reference to a resource containing the context of the request.

In the asynchronous case the exemplary information flow depicted in figure 8.2.2.3-1 is applicable. In this case it is assumed that the Originator of the Request provided two Notification Targets. (the Originator and one other Notification Target) to which notification shall be sent when the result of the requested operation is available or when the request failed.

Equivalent information flows are valid also for cases where the target resource of the requested operation is hosted on the Hosting CSE itself. From an Originator's or Notification Target's perspective there is no difference as the later notification of the result of a requested operation would always be an exchange of request/response messages between the CSE carrying out the requested operation and the Notification Targets using reference to the original Request ID.

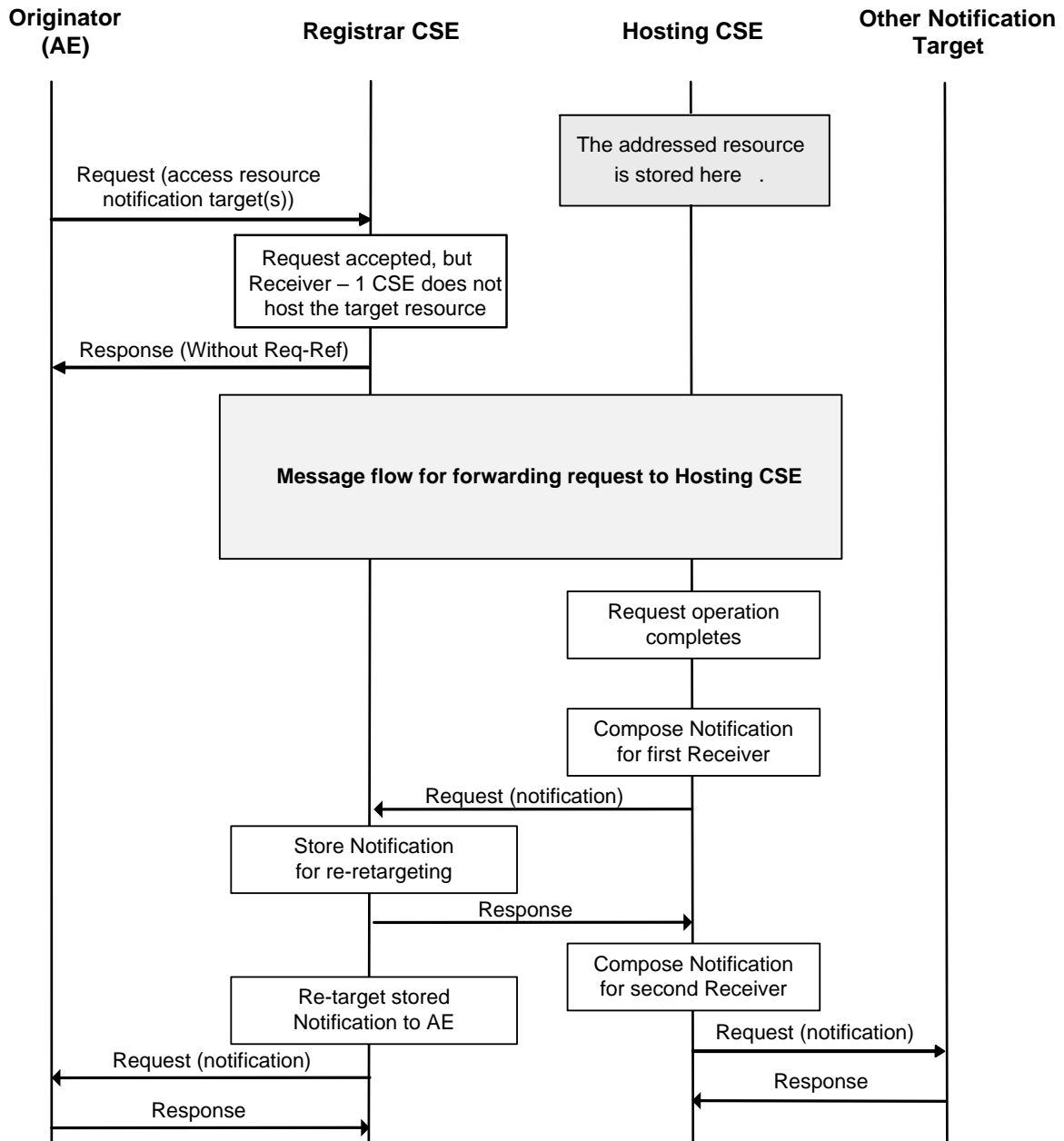

Figure 8.2.2.3-1: Non-blocking access to resource in asynchronous mode (Hosting CSE not equal to Receiver - 1 CSE), Originator provided targets for notification

8.3 Procedures for interaction with Underlying Networks

8.3.1 Introduction

Procedures for interaction with Underlying Networks are used to provide information about the M2M service layer (e.g. communication patterns of oneM2M devices) to the Underlying Network or receive information from the Underlying Network (e.g. reports on issues of the Underlying Network).

Such information enables the Underlying Network to provide means for optimization of M2M traffic and also allows M2M service layer to optimize its services.

8.3.2 Description and Flows on Mcn Reference Point

Communications between the CSEs and the NSEs across the Mcn reference point include:

- The CSE(s) accessing network service functions provided by Underlying Networks; and
- Optimizing network service processing for Underlying Networks.

Such services normally are more than just the general transport services.

Communications which pass over the Mcn reference point to Underlying Networks include:

- Messaging services that are widely deployed by Applications and network operators using a number of existing mechanisms.
- Network APIs defined by other SDOs (e.g. OMA and GSMA) are used by network operators for their services.
- Interworking for services and security aspects for MTC (Machine Type Communications) has been defined by 3GPP and 3GPP2.

Examples of service requests from a CSE towards the Underlying Networks are:

- Connection requests with/without QoS requirements.
- Payments, messages, location, bearer information, call control and other network capabilities (e.g. by using GSMA oneAPI, network APIs supporting protocols defined by other SDOs, or proprietary network APIs).
- Device triggering.
- Device management.
- Management information exchange such as charging/accounting records, monitoring and management data exchange.
- Location request.

8.3.3 Device Triggering

8.3.3.1 Definition and scope

Device Triggering is a means by which a node in the infrastructure domain (e.g. IN-CSE) sends information to a node in the field domain (e.g. ASN-CSE) to perform a specific task, e.g. to wake up the device, to establish communication from the field domain towards the infrastructure domain, or when IP address for the device is not available or reachable by the infrastructure domain.

Underlying Network functionality is used to perform device triggering for example, using alternate means of communication (e.g. SMS) with the Field Node.

NOTE: Device Triggering is applicable for the entities which are registered with IN-CSE.

Each Underlying Network type may provide different way of performing a device triggering, for example 3GPP and 3GPP2 have defined dedicated interfaces for requesting device triggering. The normative references for applicable interfaces are as follows: 3GPP TS 23.682 [i.14] and 3GPP2 X.S0068 [i.17]. Access specific mechanisms are covered in the annexes B and C.

8.3.3.2 General Procedure for Device Triggering

8.3.3.2.0 Overview

This clause covers different scenarios for device triggering.

8.3.3.2.1 Triggering procedure for targeting ASN/MN-CSE

This case describes the scenario where IN-CSE targets an ASN/MN-CSE (which is registered with the IN-CSE) for the Device Triggering request.

Figure 8.3.3.2.1-1 shows the general procedure for Device Triggering and, if required, for establishment of connectivity between IN-CSE and the Field Node.

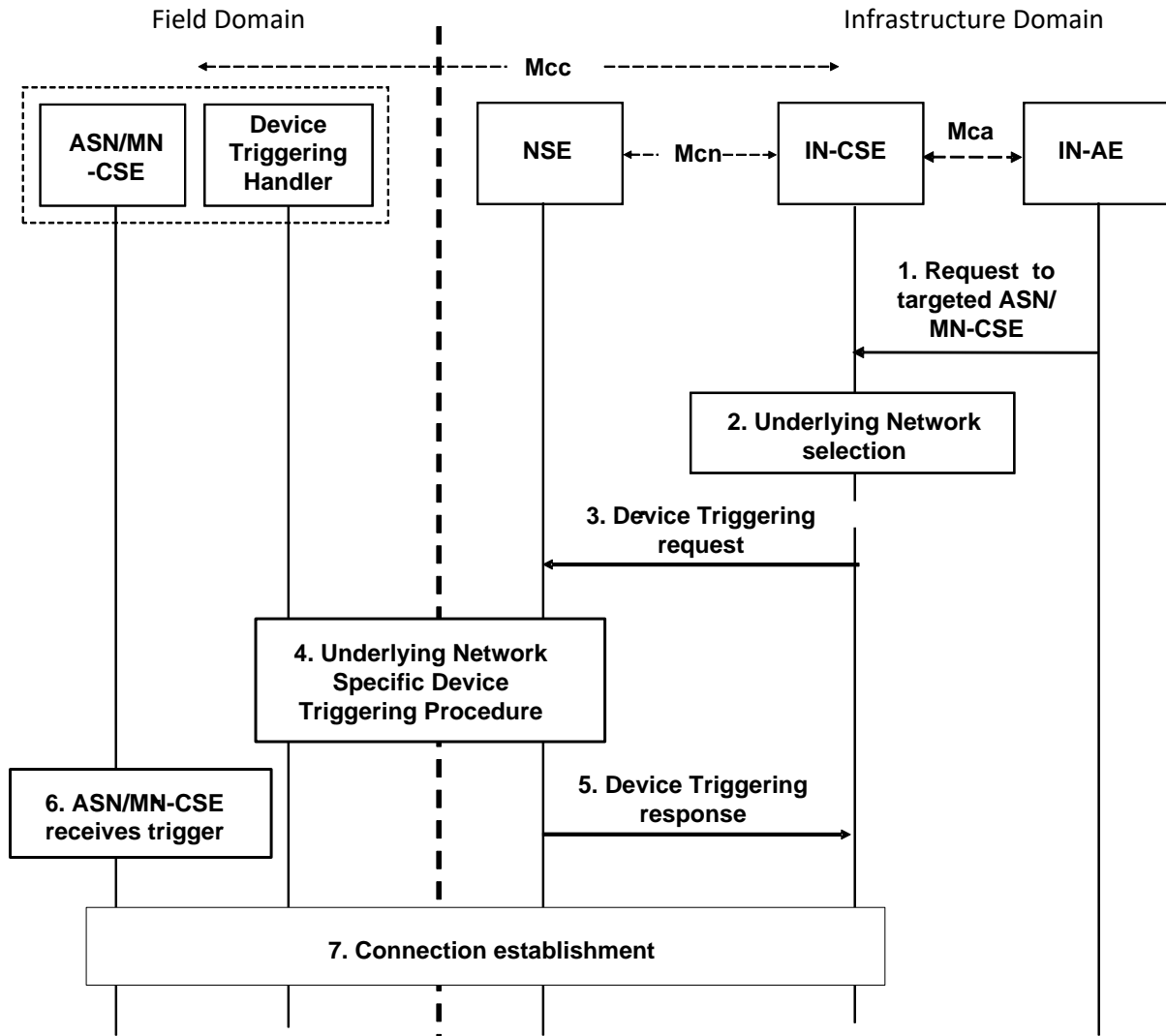

NOTE 1: The IN and ASN/MN are assumed to be connected through the same Underlying Network.

NOTE 2: The Device Triggering Handler is a functional entity that receives the device triggering request, and it is dependent on the Underlying Network. The Device Triggering Handler is out of scope of the present document.

Figure 8.3.3.2.1-1: Device Triggering general procedure for CSE

Pre-condition

The CSE which is the target of the device triggering has to be registered with the IN-CSE.

The CSE-PoA for the ASN/MN-CSE already contains either an IP address or none.

Step-1 (Optional): Request to targeted ASN/MN-CSE

The IN-AE requests to perform one of the CRUD operations on a resource residing on the ASN/MN-CSE, the request is sent via the Mca reference point to the IN-CSE.

Step-2: Underlying network selection

The IN-CSE selects the Underlying Network and the mechanism to deliver the triggering request to the Underlying Network according to the configuration for connected Underlying Networks.

For example for 3GPP access network IN-CSE can use Tsp, Tsms and GSMA OneAPI; and for 3GPP2 access networks IN-CSE can use Tsp and SMS. However the preferred mechanism is Tsp.

Step-3: Device Triggering request

IN-CSE issues the device triggering request to the selected Underlying Network.

NOTE 1: The Underlying Network dependent Device Triggering procedure for 3GPP and 3GPP2 systems are described in annexes B and Annex C respectively.

Some information provided to the selected Underlying Network for performing device triggering includes:

- M2M-Ext-ID associated with the ASN/MN-CSE as the target of the triggering request (see clause 7.1.8).
- Trigger-Recipient-ID associated with the ASN/MN-CSE (see clause 7.1.10). For example when 3GPP Underlying Network is used this identifier could map to Application-Port-ID.
- IN-CSE ID which could be used by the Underlying Network to authorize the IN-CSE for device triggering.
- Optional Trigger Payload which includes a *triggerPurpose* field and a *triggerInfoAddress* field:
 - If the Trigger Payload is present: the trigger is a request for the trigger recipient to establish a connection and to refresh its PoA.
 - If the Trigger Payload is not present: the trigger is a request for the trigger recipient to establish a connection.

NOTE 2: The M2M-Ext-ID may be pre-provisioned at the IN-CSE along with the associated CSE-ID, or may be sent at registration (see clause 7.1.8).

NOTE 3: The above Trigger-Recipient-ID is sent at registration.

NOTE 4: It is left to Stage 3 to develop the bit encoding for the payload fields.

Step-4: Underlying Network Specific Device Triggering procedure

Device Triggering processing procedure is performed between the Underlying Network and the target Node which hosts the ASN/MN-CSE.

Step-5: Device Triggering response

The IN-CSE receives a response for the Device Triggering request via the Mcn reference point.

Step-6: ASN/MN-CSE Receives Device Trigger

If the trigger had no optional trigger payload, the ASN/MN-CSE assumes that the purpose of the trigger is to cause the ASN/MN-CSE to establish connectivity with the IN-CSE. In this case, the address of the IN-CSE shall already be known to the ASN/MN-CSE.

If the trigger has an optional trigger payload, the ASN/MN-CSE uses the *triggerPurpose* to determine the appropriate action and perform the necessary steps.

Step-7 (Optional): Connection establishment

In case that it is required by the Device Triggering request, connectivity is established between the ASN/MN-CSE and the IN-CSE and the renewal of the CSE-PoA might be needed.

8.3.3.2.2 Support for device trigger recall/replace procedure

Figure 8.3.3.2.2-1 shows a generic procedure for device triggering recall/replace between oneM2M and 3GPP network.

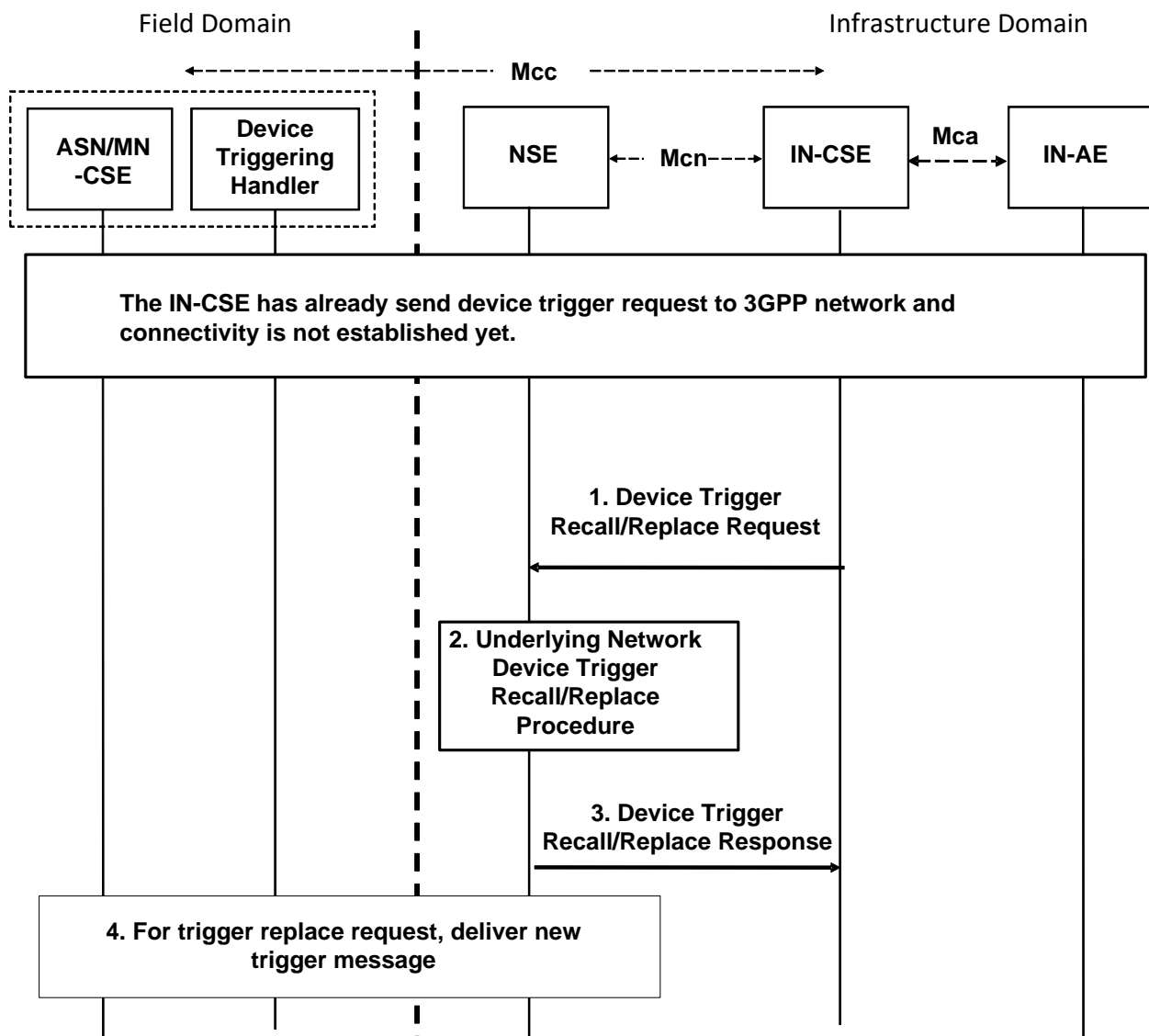

Figure 8.3.3.2.2-1: General device triggering recall/replace procedure between oneM2M and 3GPP network

Pre-condition

The IN-CSE has already sent device trigger request to 3GPP network and connectivity is not established yet. IN-CSE has already stored the previous device trigger information, e.g. trigger reference number, etc.

Step-1: Device Trigger Recall/Replace request

IN-CSE issues the device trigger Recall/Replace request to 3GPP network.

In addition to same parameters in the original device trigger request, the following additional parameters for 3GPP device trigger recall/replace include:

- The old trigger reference number was assigned to the previously submitted trigger message that the IN-CSE wants to recall/replace.
- For trigger replace request, the new trigger reference number which is assigned by the IN-CSE to the newly submitted trigger message.

Step-2: 3GPP Network Device Trigger Recall/Replace procedure

Device Trigger Recall/Replace procedure is performed in 3GPP Network, which is specified in 3GPP TS 23.682 [i.14].

Step-3: 3GPP Device Trigger Recall/Replace response

The IN-CSE receives a response for the Device Trigger Recall/Replace request via the Mcn reference point.

If the IN-CSE receives a success response, the IN-CSE updates the device trigger information as following:

- For device trigger replace success response, the IN-CSE shall store the new trigger reference number replace the old trigger reference number.
- For device trigger recall success response, the IN-CSE shall clear the old trigger reference number.

Step-4: For trigger replace request, deliver new trigger message.

For trigger replace request, the new trigger message will be delivered to the target Node as specified in 3GPP TS 23.682 [i.14].

8.3.4 Location Request

8.3.4.1 Definition and Scope

Location Request is a means by which a CSE requests the geographical or physical location information of a target CSE or AE hosted in a M2M Node to the location server located in the Underlying Network over Mcn reference point. This clause describes only the case of location request when the attribute *locationSource* is set to Network Based.

8.3.4.2 General Procedure for Location Request

This procedure describes a scenario wherein an AE sends a request to obtain the location information of a target AE or CSE hosted in an M2M Node to the location server NSE, and the location server responds to the CSE with location information.

Figure 8.3.4.2-1 shows the general procedure for Location Request.

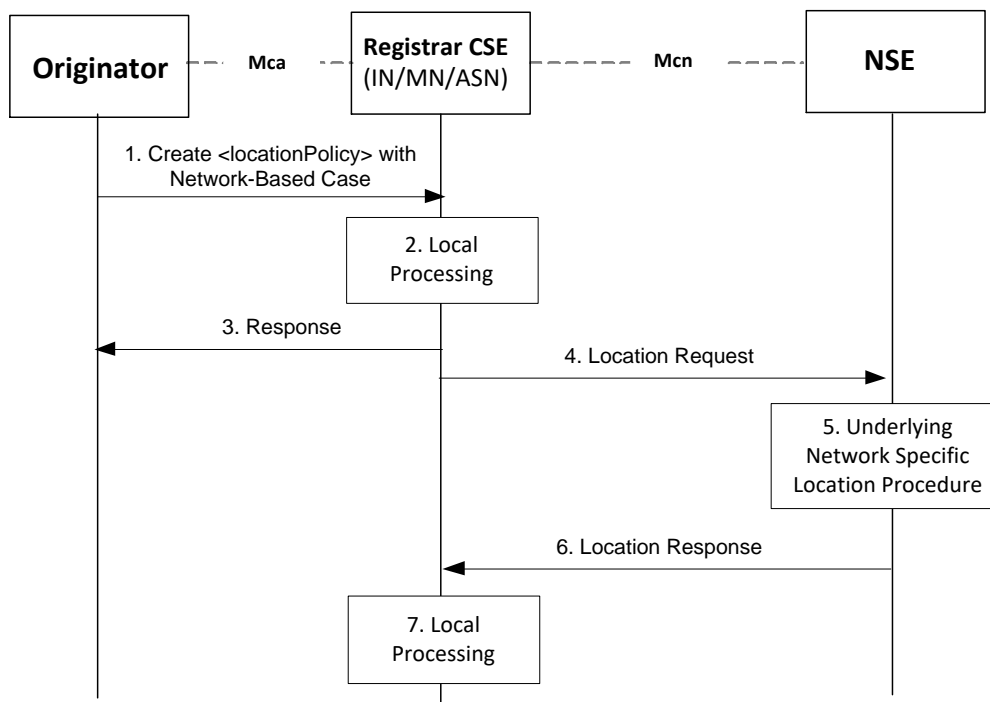

Figure 8.3.4.2-1: General Procedure for Location Request

NOTE 1: Detailed descriptions for Step-1 to the Step-3 are described in the clause 10.2.11.1.

Step-1: Create <locationPolicy>

The Originator requests to CREATE <locationPolicy> resource at the Registrar CSE. The *locationSource* attribute of the <locationPolicy> resource shall be set to 'Network-Based' and the value for *locationTargetID* and *locationServer* attributes shall be set properly set for the Location Request.

Step-2: Local Processing for creating <locationPolicy> resource

After verifying the privileges and the given attributes, the Hosting CSE creates <container> resource where the actual location information is/are stored. Then the Hosting CSE shall create <locationPolicy> resource. The Hosting CSE shall maintain cross-reference between both resources: *locationContainerID* attribute for <locationPolicy> resource and *locationID* attribute for <container> resource.

Step-3: Response for creating <locationPolicy>

The Registrar CSE shall respond with a Response message.

Step-4: Location Request

The Registrar CSE issues Location Request to the selected Underlying Network. For doing this, the Registrar CSE shall transform the location configuration information received from the Originator into Location Request that is acceptable for the Underlying Network. For example, the Location Request can be one of existing location acquisition protocols such as OMA Mobile Location Protocol [i.5] or OMA RESTful NetAPI for Terminal Location [i.6]. Additionally, the Registrar CSE shall provide default values for other parameters (e.g. required quality of position) in the Location Request according to local policies.

NOTE 2: The Location Request can be triggered by the given conditions, e.g.:

- 1) When the *locationUpdatePeriod* attribute has expired, or if the *locationUpdatePeriod* attribute is not given from the Step-1.
- 2) The <locationPolicy> is created or updated.
- 3) The linked <container> has been retrieved.
- 4) If the attribute *locationUpdatePeriod* has multiple value and the Hosting CSE of the resource is the target device, the Hosting CSE of the resource may update the location update period by choosing one of the value within the list according to the local context information of the device (velocity, battery level, current range) and its pre-provisioned local policy which is out of scope of the specification. The Hosting CSE then issues Location Request with selected value as the update period. Then, if the value switches to another value, step-4,5,6,7 shall be repeated using the new period.

Step-5: Performing Location Procedure

The Underlying Network specific procedures are performed. This may involve getting location information from the target device or the network node. These procedures are outside the scope of oneM2M specifications.

Step-6: Location Response

The NSE responds to the Registrar CSE with location information if the Registrar CSE is authorized. If not, the NSE sends an error code back to the Registrar CSE.

Step-7: Local Processing after Location Response

The received response shall be contained in the <container> resource that is related the <locationPolicy> resource.

NOTE 3: Please see the clause 10.2.11.2 for detail information.

NOTE 4: For notification regarding the location response towards the Originator, the subscription mechanism is used.

8.3.5 Configuration of Traffic Patterns

8.3.5.1 Purpose of Configuration of Traffic Patterns

M2M devices that have predictable communication behaviour - e.g. in the form of repeating traffic patterns - can profit in terms of reduction of signalling, energy saving, fewer sleep/wake transitions, etc., when their traffic patterns are communicated to the underlying network.

EXAMPLE 1: 3GPP devices could use new 3GPP power savings features such as eDRX (extended discontinuous reception) and PSM (Power Saving Mode) on LTE devices.

Also the underlying network can benefit from being informed about a device's traffic patterns by the oneM2M System.

EXAMPLE 2: If the IN-CSE knows the device's traffic patterns and transmits them to an underlying 3GPP network, then this information can be used by a 3GPP network to set the device's "Maximum Response Time" (3GPP Term) to tune the UE's DRX and PSM parameters.

Thus the network will benefit because the UE will have fewer sleep/wake transitions and unnecessary signalling in the network can be avoided. Also, if the IN-CSE knows when the device is awake then data can be sent to the device exactly at the time when the device is listening, thus requiring the network to buffer less data for unavailable devices.

The purpose of the Configuration of Traffic Patterns feature is to provide a means to the oneM2M System to inform the Underlying Network on parameters that can be used for optimizing the processing at the Underlying Network for a specific Field Domain Node. The feature includes the following functionalities:

- The Common Service Entity (CSE) shall be able to provide information on the traffic patterns of a Field Domain Node (ASN or MN) to the underlying network.
- To that purpose an AE shall be able to set traffic patterns of a particular Field Domain Node or a group of Field Domain Nodes via the Mca reference point of a CSE:
 - The Field Domain Node is addressed using the NodeID of the Node.
 - A group of Field Domain Nodes can be addressed by the resource identifier of a corresponding <group> resource.
- The CSE shall in turn use the Mcn interface towards the Underlying Network to provide information on Traffic Patterns of a the Field Domain Node:
 - In the case of a 3GPP network the CSE uses the M2M-Ext-ID to identify the Node towards the Underlying Network.

8.3.5.2 Traffic pattern parameters

Traffic pattern (TP) parameters can be associated with one or multiple Field Domain Nodes and are defined in table 8.3.5.2-1.

A Field Domain Node can be associated with one of TP parameters or multiple sets of TP parameters for a particular target network that have different, non-overlapping schedules. At any time only a single set of TP parameters can be associated with a Field Domain Node per underlying network.

The CSE shall assure that different TP parameter sets for a Node are not overlapping at any point in time.

A combination of the following parameters can be set.

Table 8.3.5.2-1: Traffic parameter set

TP parameter set	Description
TP Periodic communication indicator	Identifies whether the Node communicates periodically or not, e.g. only on demand.
TP Communication duration time	Duration interval time of periodic communication [may be used together with TP Periodic communication indicator]. Example: 5 minutes.
TP Time period	Interval Time of periodic communication [may be used together with TP Periodic communication indicator]. Example: every hour.
TP Scheduled communication time	Time zone and Day of the week when the Node is available for communication. Example: Time: 13:00-20:00, Day: Monday.
TP Stationary indication	Identifies whether the Node is stationary or mobile.
TP Data size indication	indicates the expected data size for the pattern.
TP Validity time	The time after which aTP parameter becomes invalid once it had been set.

8.3.5.3 General procedure for Configuration of Traffic Patterns

Figure 8.3.5.3-1 depicts a general procedure for configuration of Traffic Patterns.

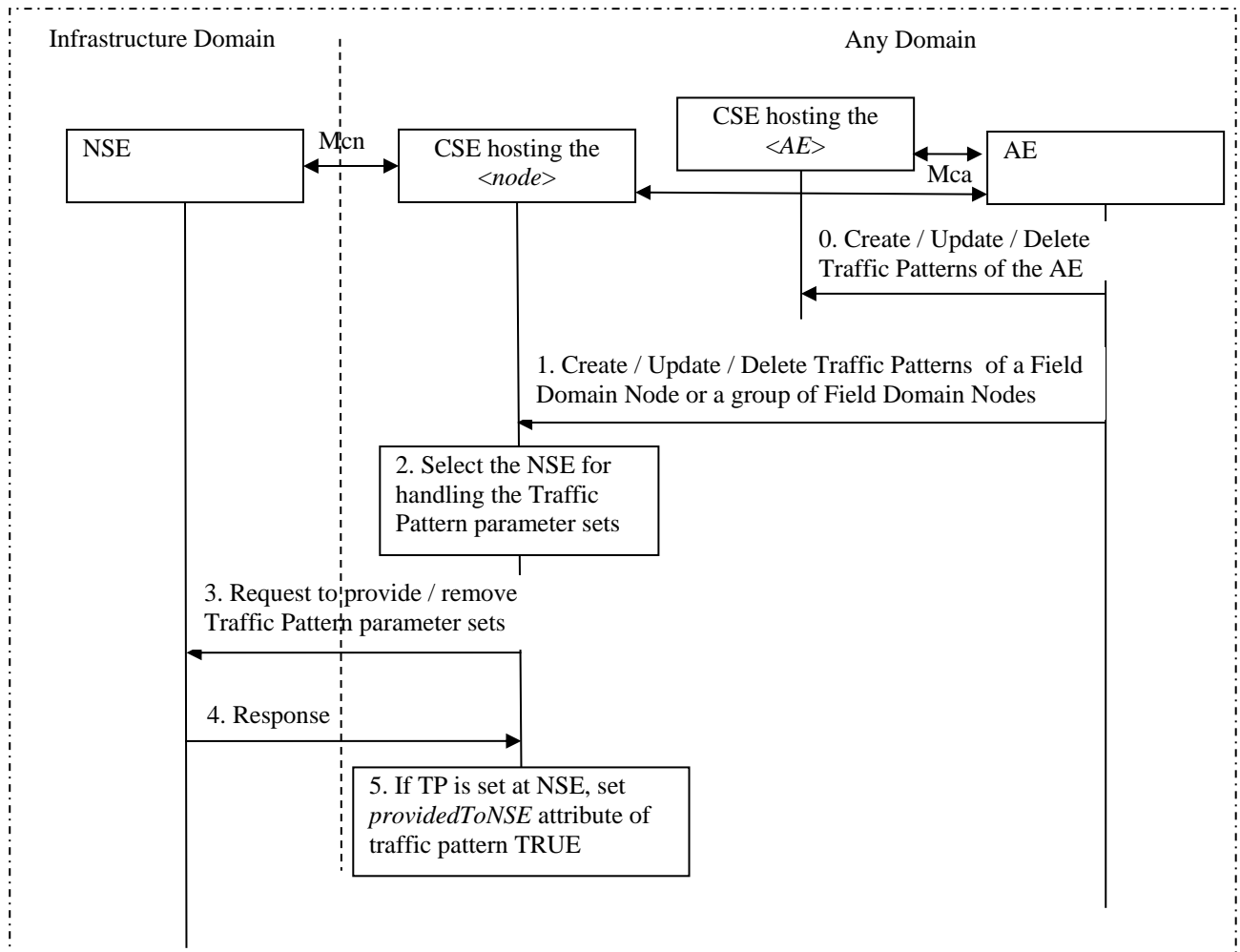

Figure 8.3.5.3-1: General procedure for configuration of Traffic Patterns

Step-0 (optional): An AE provides information on the communication behaviour of the AE

An AE may provide information on the communication behaviour of the AE by creating / updating / deleting <trafficPattern> child resources of the <AE> resource.

NOTE 1: The <trafficPattern> resources of AEs can be used in the following steps to create consolidated traffic patterns of the Node of the entity (ASN, ADN, MN) where these AEs reside.

Step-1: An AE provide information on the communication behaviour of a Field Domain Node to a CSE that hosts the <node> resource of the Field Domain Node.

If the CSE hosts the <node> resource of the Field Domain Node and supports a Mcn interface to an Underlying Network capable of transmitting traffic patterns then an AE (e.g. IN-AE or an AE of the Field Domain Node that reports the Node's communication behaviour) may provide that hosting CSE with information on the communication behaviour of the Node. This is done by creating, updating or deleting the Node's traffic patterns, each having a set of traffic pattern (TP) parameters, a schedule when the pattern applies and a validity time.

NOTE 2: If the Underlying Network is a 3GPP network then the IN-CSE may support a Mcn interface capable of transmitting traffic patterns.

Traffic patterns are contained in the <trafficPattern> child-resources of the Node's <node> resource. Their targetNetwork attribute indicates for which Underlying Network they are applicable.

The AE can provide traffic patterns for a group of Field Domain Nodes using appropriate group mechanisms.

The request shall include:

- the originator AE-ID of the requesting AE;
- a target identifier: i.e. the <node> resource of the Field Domain Node;
- a target Network (e.g. 3GPP) for which the traffic patterns of the Node are applicable
- a set of TP parameters as indicated in table 8.3.5.2-1.

The request may include multiple traffic patterns with their TP parameter set(s), schedules and validity time(s).

If the hosting CSE has received a request from an AE to create, update or delete Traffic Patterns for a Field Domain Node or a group of Field Domain Nodes,, it shall check if the request from the AE is valid.

NOTE 3: Apart from checking access rights of the AE the validation of the request from the AE could include:

- Consistency with traffic patterns of AEs residing on the entity (ASN, ADN, MN) of that Node.
- Consistency with other network related schedules of this Node (e.g. contained in the <schedule> resource pointed at by the mgmtLink attribute of a <cmdhNwAccessRule> resource of the Node).
- If several traffic patterns exist for one Field Domain Node for a particular target network, then ensure that the schedules of the different TP parameter sets are not overlapping.

Step-2: Select the NSE for handling the TP parameter sets

If the CSE receives a request to Create / Update / Delete traffic patterns the CSE selects the NSE by using the network identifier of the Field Domain Node (i.e. the M2M-Ext-ID) by which the Node can be identified in the NSE.

NOTE 4: In the case of a 3GPP network the correct NSE can be found by following of a chain of links of multiple resources in the IN-CSE, e.g. the <node> resource having the hostedCSELink linking to the <remoteCSE> resource having the M2M-Ext-ID linking to the UNetwork-ID of the NSE (see clauses 7.1.8 and 7.1.9).

Step-3: Request for the handling of the TP parameter sets

For each Field Domain Node the CSE sends a request for handling (i.e. provide or remove) TP parameter sets for the Field Domain Node to the NSE, using the appropriate Mcn protocol. The Mcn can correspond to one of standard interfaces specified by an external organization, for example, OMA RESTful Network API for Communication Patterns V1.0 [i.32]. The request shall include a corresponding network identifier of the Filed Domain Node and one or more TP parameter set(s) as defined at clause 8.3.5.2.

NOTE 5: If the Underlying Network is 3GPP-compliant, see Annex B for more details.

Step-4: Response for the handling of the TP parameter sets

The CSE receives the response for the configuration of the TP parameter sets from the NSE.

NOTE 6: If the Underlying Network is 3GPP-compliant, see annex B for more details.

Step-5: Set providedToNSE attribute of traffic pattern

If traffic patterns are provided to the NSE, (i.e. if the response to a request to provide TP parameter sets to the NSE indicated successful handling at the NSE) the CSE shall set the *providedToNSE* attribute of the related *<trafficPattern>* resource(s) to TRUE. Upon receipt of a unsuccessful response to that request the CSE shall UPDATE the *providedToNSE* attribute of the *<trafficPattern>* resource with the value FALSE.

8.4 Connection Request

Connection request service is not defined in the present document.

8.5 Device Management

See clause 6.2.4 for a detailed description on the interaction with a Device Management Server.

9 Resource Management

9.0 Overview

All entities in the oneM2M System, such as AEs, CSEs, data, etc. are represented as resources. A resource structure is specified as a representation of such resources. Such resources are uniquely addressable. Procedures for accessing such resources are also specified.

9.1 General Principles

The following are the general principles for the design of the resource model.

- The "type" of each resource shall be specified. New resource types shall be supported as the need for them is identified.
- The root of the resource structure in a CSE shall be assigned an absolute address. See clause 9.3.1 for additional information.
- The attributes for all resource type shall be specified.
- Each resource type may be instantiated as multiple resources via Create procedure (clause 10.1.1).
- All resources and associated attributes shall be addressable as specified in clause 9.3.1.
- Both hierarchical and non-hierarchical URIs shall be supported by all CSEs.

9.2 Resources

9.2.0 Overview

This clause introduces the resources used in a CSE. A resource scheme is used for modelling the resource structure and associated relationships. Clause 9.5 provides guidelines on how to describe a resource. The present document identifies three categories of resources:

- Normal resources (clause 9.2.1).
- Virtual resources (clause 9.2.2).

- Announced resources (clause 9.2.3).

9.2.1 Normal Resources

Normal resources include the complete set of representations of data which constitutes the base of the information to be managed.

Unless qualified as either "virtual" or "announced", the resource types in the present document are normal resources.

9.2.2 Virtual Resources

A virtual resource is used to trigger processing and/or retrieve results, but they do not have a permanent representation in a CSE.

9.2.3 Announced Resources

An announced resource is a resource at a remote CSE that is linked to the original resource that has been announced, and it maintains some of the characteristics of the original resource.

Resource announcement can facilitate resource discovery. The announced resource at a remote CSE can also be used for creating child resources at the remote CSE that are not present as children of the original resource or are not announced children of the original resource.

The following are the resource specification guidelines for resource announcement:

- In order to support announcement of resources, an additional column in the resource template (clause 9.5.1), shall specify the attributes to be announced for inclusion in the associated announced resource type.
- For each announced *<resourceType>*, the addition of suffix "Annc" to the original *<resourceType>* shall be used to indicate its associated announced resource type. For example, resource *<containerAnnc>* shall indicate the announced resource type for *<container>* resource; *<groupAnnc>* shall indicate announced resource type for *<group>* resource, etc.

9.3 Resource Addressing

9.3.1 Generic Principles

An address of a resource is a string of characters used to uniquely identify the targeted resource within the scope of a request to access the resources. The scope of a request can be:

- CSE-relative: The request is targeting a resource that resides on the same CSE as the Receiver CSE of the request. In that case a CSE-relative format of a resource ID can be used to address the resource.
- SP-relative: The request is targeting a resource that resides on a CSE within the same M2M SP domain as the Originator of the request. In that case an SP-relative format of a resource ID can be used to address the resource.
- Absolute: The request is targeting a resource that resides on a CSE that is within an M2M SP domain that is different from the M2M SP domain of the Originator of the request. In that case the absolute format of a resource ID shall be used to address the resource. Note that the absolute format of the resource ID will always be acceptable also in other cases.

A single resource may have more than one way of constructing a resource ID, via which access to the resource can be provided.

There are two different methods for addressing a resource within the oneM2M resource structure with three different variants each depending on the scope of the request to access the resource. The ways how the resource IDs shall be constructed in each case are as follows.

Table 9.3.1-1 Resource addressing methods

Method	Request Scope		
	CSE-Relative	SP-Relative	Absolute
<i>Non-Hierarchical</i>	Use the 'Unstructured-CSE-relative-Resource-ID' format of the resource ID as defined in table 7.2-1.	Use the 'SP-relative-Resource-ID' format of the resource ID constructed with the 'Unstructured-CSE-relative-Resource-ID' as defined in table 7.2-1.	Use the 'Absolute-Resource-ID' format of the resource ID constructed with the 'Unstructured-CSE-relative-Resource-ID' as defined in table 7.2-1.
<i>Hierarchical</i>	Use the 'Structured-CSE-relative-Resource-ID' format of the resource ID as defined in table 7.2-1.	Use the 'SP-relative-Resource-ID' format of the resource ID constructed with the 'Structured-CSE-relative-Resource-ID' as defined in table 7.2-1.	Use the 'Absolute-Resource-ID' format of the resource ID constructed with the 'Structured-CSE-relative-Resource-ID' as defined in table 7.2-1.

These two methods with three variants shall all be supported by all M2M Nodes, notably the CSEs receiving requests, before they proxy these requests any further, where applicable.

For hierarchical addressing a known ancestor of the targeted resource shall be used in combination with one or more *resourceName* attribute values of child or sub-child resource(s) to represent parent-child relationships of resources for all of the above request scopes. In line with the definition of 'Structured-CSE-relative-Resource-ID' in Table 7.2-1, the following rules for constructing the 'Structured-CSE-relative-Resource-ID' format used in hierarchical addressing of a resource shall apply:

Structured-CSE-relative-Resource-ID = {parent-segment}/{child-segment}/{subsequent-child-segment}]

where the following assumptions hold:

- { } denotes a placeholder for a sequence of characters that may include any of the unreserved characters defined in the clause 2.3 of the IETF RFC 3986 [i.10], see also table 7.2-1.
- Each placeholder in { } is termed a "segment" in this context.
- [] denotes zero or more occurrences of the argument between [and].
- {parent-segment} is one of the following:
 - the resource name of <CSEBase> resource;
 - the character "-" (dash) as a shortcut for the resource name of <CSEBase> resource;
 - the 'Unstructured-CSE-relative-Resource-ID' of a parent resource that is the starting ancestor used to address the target resource with hierarchical addressing.
- {child-segment} is equal to the *resourceName* attribute value of the specific child resource - among the children of the resource that is identified by {parent-segment} - which is:
 - either the next ancestor on the path to the target resource;
 - or the target resource itself.
- {subsequent-child-segment} is equal to the *resourceName* attribute value of the specific child resource - among the children of the resource that is identified by the "/"-separated concatenation of the previous segments - which is:
 - either the next ancestor of the target resource;
 - or the target resource itself.

Examples for resource addressing are given in annex I.

The CSE-ID of the particular CSE that is represented by a specific instance of a <CSEBase> resource, which is the first segment in the path portion of an SP-relative or Absolute format of a Resource, allows to easily distinguish different CSEs on the same IP host.

9.3.2 Addressing an Application Entity

9.3.2.1 Application Entity Addressing

In M2M communication, the goal of M2M addressing is to reach the CSE with which the target AE is registered, and ultimately the target AE on the M2M Node on which the target AE is resident. This principle applies to all Application Entities.

Reachability and routing from/to AEs on M2M Nodes is associated with the CSEs with which these AEs are registered, and the connectivity of such CSEs to the Underlying Networks. Reaching an AE shall be performed through reaching the CSE the AE is registered with. A CSE-PoA (CSE Point of Access) shall provide the set of information needed to reach a CSE from an Underlying Network perspective. Typically a CSE-PoA contains information that is resolved into a network address.

9.3.2.2 Application Entity Reachability

9.3.2.2.1 CSE Point of Access (CSE-PoA)

The CSE-PoA shall be used by the M2M System to communicate with a CSE on an M2M Node. Once communication with a CSE is achieved, an AE registered with that CSE can be reached as long as the AE can be uniquely identified.

The information included in the CSE-PoA as well as the refresh of the CSE-PoA, depends on the characteristics of the Underlying Network and an M2M Node's transport capabilities.

9.3.2.2.2 Locating Application Entities

Locating an AE is a two-step process as follows:

- **Step 1:** There is a need to locate the CSE where the AE is registered. Locating the CSE shall be accomplished as follows:
 - For AEs associated with ASNs/MNs/INs, the CSE-PoA of the ASN-CSE/MN-CSE/IN-CSE where the AE is registered shall be used.
 - For AEs associated with ADNs, the CSE-PoA of the MN-CSE/IN-CSE where the ADN is registered shall be used.
- **Step 2:** The CSE shall locate the appropriate AE using its Application Entity Identifier (AE-ID).

9.3.2.2.3 Usage of CSE-PoA by the M2M System

9.3.2.2.3.0 Overview

The CSE-PoA holds the information used by the M2M System to locate routing information for a CSE. This information shall be provided by the CSE at registration time. However, the routing information related to a CSE (and ultimately to the target AE) in an M2M System depends on the characteristics of the Underlying Network. This impacts the criteria for updating the CSE-PoA by the registered CSE, in addition to the regular CSE registration updates. The information to be conveyed as CSE-PoA needs to support Underlying Network specifics.

CSE-PoA is considered equivalent to the routable addresses of the targeted CSE.

In general the addressing and routing information related to a CSE can be achieved when a static public IP address is assigned to and M2M Node and direct DNS address translation or dynamic DNS address translation is used.

In those circumstances, the CSE-PoA for a registered CSE shall have a URI conforming to IETF RFC 3986 [i.10] as follows:

- URI = scheme://fullyqualifieddomainname/path/; or
- URI = scheme://ip-address/path/.

The following clauses specify the information to be conveyed in the CSE-PoA by a registered CSE for various types of Underlying Networks, as well as the criteria for updating the CSE-PoA for the registered CSEs, in addition to the normal CSE registration refresh.

9.3.2.2.3.1 CSE-PoA related to CSEs associated with a Fixed Network

In this case the CSE-PoA for a registered CSE shall have a URI as described above. If the IP address is private, then the address is usually built based on the address of the related PPP protocol which is a public IP address. This in turn is mapped to the corresponding private address.

9.3.2.2.3.2 CSE-PoA related to CSEs associated with Mobile Networks

If the IP address for the registered CSE cannot be reliably used, and cannot be included in the CSE-PoA, then the CSE-PoA for the registered CSE shall include appropriate information as required by the respective Underlying Networks and supported by oneM2M.

Each Underlying Network shall need to specify the means for allowing an M2M SP to fetch the IP address associated with a CSE attaching to that Underlying Network and consequently the information to be included in the CSE-PoA for the registered CSE.

In the event that the M2M SP has connections to multiple Underlying Networks, there is a need to establish a binding between the registered CSE and the associated Underlying Network. That binding may be established through CSEs explicitly identifying the Underlying Network at registration/update time. Otherwise the M2M SP may derive the identity of the Underlying Network, e.g. by using the link, over which the registration arrived, store it and bind it to the registration information.

In the scenarios an M2M Node in mobile networks is not reachable by the previously known IP address and it supports SMS, the originating CSE can make use of SMS for device triggering mechanism to wake up the M2M Node to renew the IP addresses or perform specific functionalities.

To support this option, the CSE-PoA shall, on Mcn interface to the Underlying Networks supporting such an SMS for device triggering mechanism, include identification information of the CSE (such as the external identifier as defined by 3GPP TS 23.682 [i.14] in the case of Tsp-based triggering, or MSISDN or any identifier used by triggering network APIs), and send the request to the Underlying Network via the mechanisms supported, such as Tsp, Tsms, Network APIs.

Annex B shows the 3GPP defined interfaces for machine type communication interfaces and example device triggering flows.

9.3.2.2.3.3 CSE-PoA to CSEs associated with multiple Underlying Networks

When an M2M Node attaches to a fixed network, the CSE-PoA for a registered CSE shall conform to the procedures associated with the fixed network.

When an M2M Node attaches to a mobile network, the CSE-PoA for a registered CSE shall conform to the procedures associated that mobile network.

If an M2M Node is already attached to an Underlying Network and attaches to another Underlying Network, the CSE may update its PoA information at the remote CSE.

9.3.2.3 Notification Re-targeting

9.3.2.3.1 Application Entity Point of Access (AE-PoA)

A Notify request to an AE is sent by targeting <AE> resource on a Hosting CSE. If the Hosting CSE verifies access control privilege of the Originator, the Hosting CSE shall re-target the request to the address specified as AE-PoA (i.e. pointOfAccess attribute of <AE> resource). The AE-PoA may be initially configured in the <AE> resource when the AE registers to the Registrar CSE. If the <AE> resource does not contain an AE-PoA, an active communication link, if available, can be used for re-targeting. If neither of them is available, the request cannot be re-targeted to the AE.

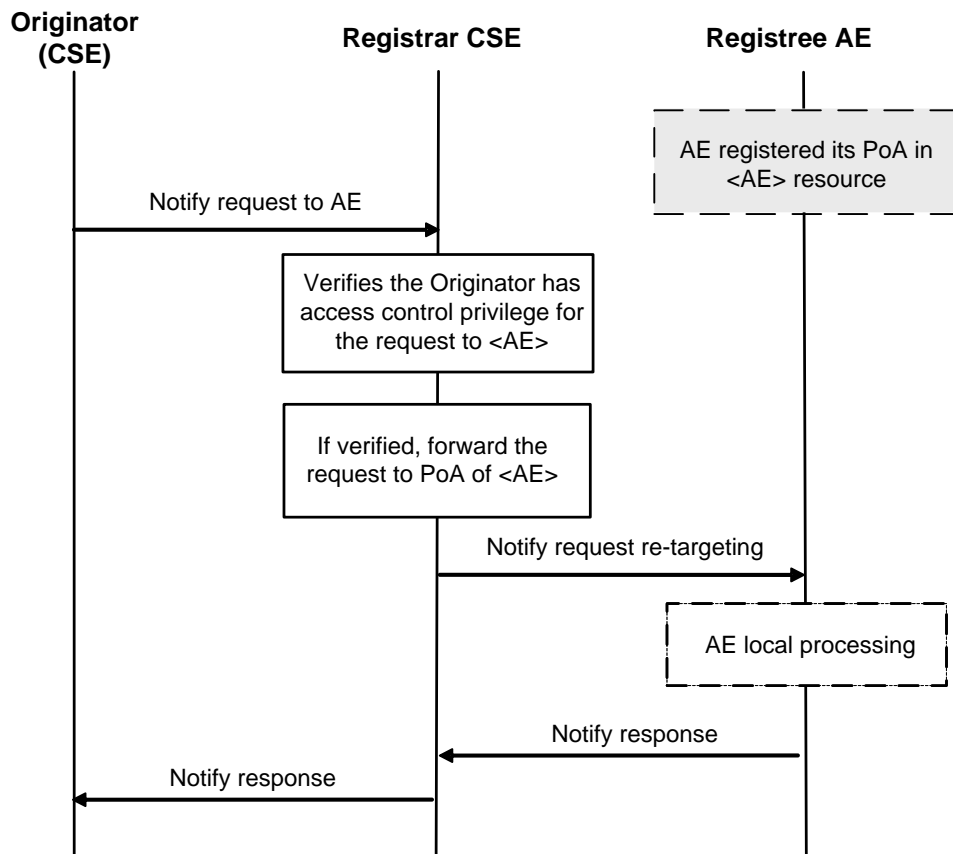
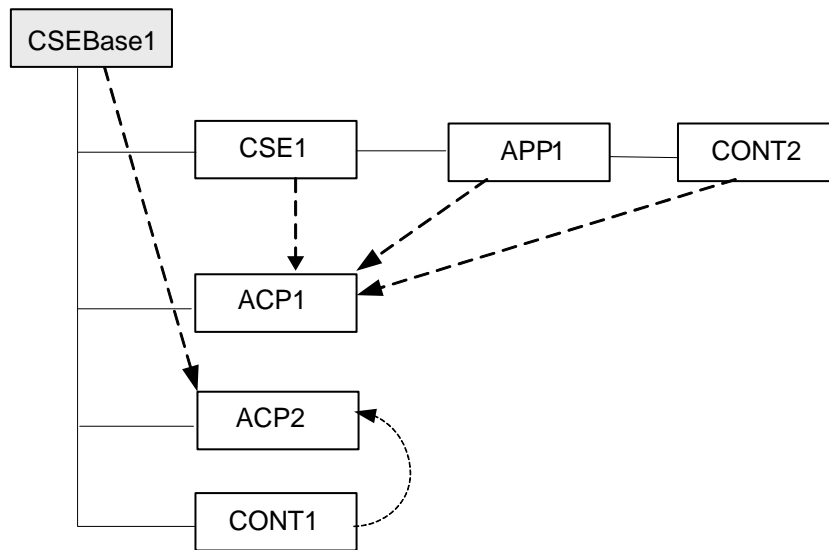

Figure 9.3.2.3.1-1: Re-targeting a notification request to an AE

9.4 Resource Structure

9.4.1 Relationships between Resources



- NOTE: The resources shown are:
- CSEBase1 is the name of a resource of type `<CSEBase>`.
 - CSE1 is the name of a resource of type `<remoteCSE>`.
 - APP1 is the name of a resource of type `<AE>`.
 - CONT1 and CONT2 are the names of resources of type `<container>`.
 - ACP1 and ACP2 are the names of resources of type `<accessControlPolicy>`.

Figure 9.4.1-1: Resource Relationships Example in a CSE

The solid line in figure 9.4.1-1 represents parent-child relation, which is supported by a link (e.g. *parentID*) in the non-hierarchical addressing method, and by the hierarchical addressing method.

Dashed line in figure 9.4.1-1 represents a link i.e. a relationship between the resources (e.g. relationship between the APP1 resource and the ACP1).

Figure 9.4.1-1 provides an example of a resource structure. The represented resources can be addressed by using one of the methods described in clause 9.3.1. Resources in the oneM2M System are linked with each other and they respect the containment relationship. The methods for linking resources are described in clause 9.4.2.

A link shall contain the following information:

- **Linked Resource:** The target linked resource is given by using the ID of that resource.
- **Link Relation:** Describes the relationship that the current resource has with the linked resource (only in one direction, i.e. from this resource to the linked resource).

9.4.2 Link Relations

The following link relations are defined.

Table 9.4.2-1: Link Relations

Linked Resource Type (link destination)	Linking Resource Types (link origin)	Linking Method	Description
<i>accessControlPolicy</i>	Several (e.g. <i>node</i> , <i>AE</i> , <i>remoteCSE</i> , <i>container</i>)	Attribute named <i>accessControlPolicyIDs</i>	See clause 9.6.2
<i>node</i>	<i>CSEBase</i> , <i>remoteCSE</i> , <i>AE</i>	Attribute named <i>nodeLink</i>	See clause 9.6.3 See clause 9.6.4 See clause 9.6.5
<i>CSEBase</i> or <i>remoteCSE</i>	<i>node</i>	Attribute named <i>hostedCSELink</i> OR parent resource of type <i>CSEBase</i>	See clause 9.6.18
a parent resource of any <i>resourceType</i>	A child resource of any <i>resourceType</i>	Attribute named <i>parentID</i>	See clause 9.6.1.3
a child resource of any <i>resourceType</i>	A parent resource of any <i>resourceType</i>	Child resource itself	See clause 9.6
<i>mgmtObj</i>	<i>mgmtObj</i>	Attribute named: <i>mgmtLink</i>	See clause 9.6.15
<i>contentInstance</i>	<i>contentInstance</i>	Attribute named <i>contentRef</i>	See clauses 9.6.7 and 9.6.35
<i>dynamicAuthorizationConsultation</i>	Several (e.g. <i>node</i> , <i>AE</i> , <i>remoteCSE</i> , <i>container</i>)	Attribute named: <i>dynamicAuthorizationConsultationIDs</i>	See clause 9.6.40

9.5 Resource Type Specification Conventions

9.5.0 Overview

The following conventions are used for the specification of resources.

Resources are specified via a tabular notation and the associated graphical representation as follows:

- The resources are specified in association with a CSE. The resources are the representation in the CSE of the components and elements within the oneM2M System. Other CSEs, AEs, application data representing sensors, commands, etc. are known to the CSE by means of their resource representation. Resource, Child Resource and Attributes are defined in clause 3.1 and are restated below for readability:
 - **Resource:** A Resource is a uniquely addressable entity in oneM2M architecture. A resource is transferred and manipulated using CRUD operations (see clause 10.1). A resource can contain child resource(s) and attribute(s).
 - **Child Resource:** A sub-resource of another resource that is its parent resource. The parent resource contains references to the child resources(s).
 - **Attribute:** Stores information pertaining to the resource itself.
- The set of attributes, which are common to all resources, are not detailed in the graphical representation of a resource.
- Resource names and attribute names are strings in lower case. In case of a composed name, the subsequent word(s) start with a capital letter; e.g. *accessControlPolicy*, *creationTime*, *expirationTime*.
- Resource type names and attribute names are written in *italic* form in the present document.

- A string containing resource type name in *italic* delimited with '<' and '>' e.g. <resourceType> is used as an abbreviation referring to the type of a resource. For example the text "a <container> resource" could be used as an abbreviation for "a resource of type *container*".
- A string containing a resource type name delimited with '[' and ']' e.g. [resourceType] is an abbreviation referring to a specialization of a resource type.
- Specialization of a resource type is done by defining specific names and descriptions of the attributes that can be specialized from the base resource type. For example the text "a [battery] resource" could be used as an abbreviation for "a resource of type *battery*", where battery is a specialization of base resource type *mgmtObj*.
- A string containing an attribute type name in *italic* delimited with '[' and ']', e.g. [objectAttribute] is used as an abbreviation referring to a type of an attribute that can be specialized. Attributes that can be specialized only occur in resource types that can be specialized.

The resources are specified as shown in figure 9.5.0-1.

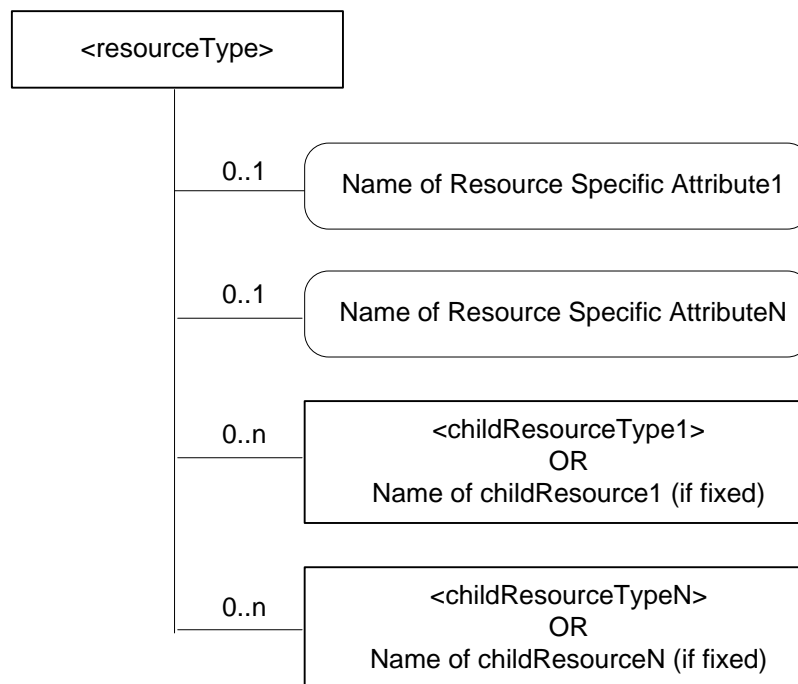

Figure 9.5.0-1: <resourceType> representation convention

The resource specification provides the graphical representation for the resource as in figure 9.5.0-1. The graphical representation of a resource shows the multiplicity of the attributes and child resources. The set of attributes, which are common to all resources are not detailed in the graphical representation of a resource. The following graphical representations are used for representing the attributes and child resources:

- Square boxes are used for the resources.
- Square boxes with round corners are used for attributes.

Child resources in a <resourceType> are detailed as shown in table 9.5.0-1.

The child resource table for an announce-able <resourceType> resource includes an additional column titled '<resourceTypeAnnnc> Child Resource Types', indicating the type of announced resources. See clause 9.6.26 for further details.

An announced resource may have child resources, and such child resources can be of type "normal" or "announced". Child resources are of type "announced" when the child resources are announced independently of the original resource, as needed by the resource announcing CSE. Child resources are of type "normal" when child resources at the announced resource are created locally by the remote CSE.

Table 9.5.0-1: Child Resources of <resourceType>

Child Resources of <resourceType>	Child Resource Type	Multiplicity	Description	<resourceTypeAnnc> Child Resource Types
<Fill in the name of Child Resource1 if a fixed name is required or [variable] if no fixed name is required>	<Fill in the type of Child Resource1>	<Fill in Multiplicity>	See clause <XRef> <clause> where the type of this child resource is described.	<Fill the child resource type for the announced resource. It can be none or <crTypeAnnc> or <crType>; where the <crType> is the child resource type of the original Child Resource1.
<Fill in the name of Child ResourceN if a fixed name is required or [variable] if no fixed name is required>	<Fill in the type of Child ResourceN>	<Fill in Multiplicity>	See clause <XRef> <clause> where the type of this child resource is described.	<Fill the child resource type for the announced resource. It can be none or <crTypeAnnc> or <crType>; where the <crType> is the child resource type of the original Child ResourceN.

Attributes in a <resourceType> are detailed as shown in table 9.5.0-2.

The attributes table for announce-able <resourceType> resource includes an additional column titled 'Attributes for <resourceTypeAnnc>', indicating the attributes that are to be announced for that <resourceType>. See the clause 9.6.26 for further details.

Table 9.5.0-2: Attributes of <resourceType> resource

Attributes of <resourceType>	Multiplicity	RW/RO/WO	Description	<resourceTypeAnnc> (MA/OA/NA)
<Fill in name of Common Attribute1>	<Fill in Multiplicity>	<Fill in RW or RO or WO>	Provide description of this attribute - to be moved later to a common attribute clause.	<Fill in MA or OA or NA>
<Fill in name of Common AttributeN>	<Fill in Multiplicity>	<Fill in RW or RO or WO>	Provide description of this attribute - to be moved later to a common attribute clause.	<Fill in MA or OA or NA>
<Fill in name of Resource Specific Attribute1>	<Fill in Multiplicity>	<Fill in RW or RO or WO>	Provide description of this attribute - to be moved later to a central attribute table that also defines the type of the attribute, allowed ranges, etc.	<Fill in MA or OA or NA>
<Fill in name of Resource-Specific AttributeN>	<Fill in Multiplicity>	<Fill in RW or RO or WO>	Provide description of this attribute - to be moved later to a central attribute table that also defines the type of the attribute, allowed ranges, etc.	<Fill in MA or OA or NA>

In case of misalignment of the graphical representation of a resource and the associated tabular representation, tabular representation shall take precedence.

The access modes for *attributes* can assume the following values:

- Read/Write (RW): the value of the attribute is set when the resource is Created or Updated based on information from the Originator (i.e. **Content** parameter). Such attributes are allowed for Create/Update/Retrieve operations. Note that such an attribute can be deleted by Update operation.
- Read Only (RO): the value of the attribute is set or can be updated by the Hosting CSE internally. Such an attribute is allowed for Retrieve operation only.
- Write Once (WO): the value of the attribute is set when the resource is Created based on information from the Originator (i.e. **Content** parameter). Such an attribute is allowed for Retrieve operation after the creation. Such attribute can thereafter only be updated by hosting CSE internally.

The multiplicity, both for the child resources and the attributes can have the following values:

- A value of "0" indicates that the child resource/attribute shall not be present.
- A value of "1" indicates that the child resource/attribute shall be present.
- A value of "0..1" indicates that the child resource/attribute may be present.
- A value of "0..n" indicates that the child resource/attribute may be present. If present, multiple instances are supported.
- A value of "1..n" indicates that the child resource shall always be present. It has at least one instance and can have multiple instances.
- An attribute multiplicity post-fixed with (L) indicates that it is a list of values.

The attributes for *<resourceTypeAnnc>* in the attribute table can have the following set of values:

- **MA (Mandatory Announced):** The attribute in the original resource is announced to the announced resource. The content of such an announced attributes is the same as the content of the original attribute.
- **OA (Optional Announced):** The attribute in the original resource may be announced to the announced resource depending on the contents of the *announcedAttribute* attribute at the original resource. The content of such an announced attribute is the same as the content of the original attribute.
- **NA (Not Announced):** The original attribute is not announced to the announced resource.

9.5.1 Handling of Unsupported Resources/Attributes/Sub-resources within the M2M System

A CSE shall respond to a received request targeted to it and that includes resource(s), resource attribute(s) or sub-resource(s) that are not supported by it, by sending an appropriate error code back to the request Originator.

When a CSE is not the target entity of a received request, the CSE shall attempt to forward the received request to the targeted entity. If the CSE cannot forward the received request for any reason, it shall respond to the received request by sending an appropriate error code back to the request Originator. The present document includes both mandatory and optional functionalities for interfaces between oneM2M entities. Thus, the functionality implemented for the interfaces may not include all the functionalities specified in the present document.

9.6 Resource Types

9.6.1 Overview

9.6.1.1 Resource Type Summary

Table 9.6.1.1-1 introduces the normal and virtual resource types and their related child or parent resource types. Details of each resource type follow in the remainder of this clause.

Table 9.6.1.1-1 lists each specified ordinary - i.e. not announced - resource type. An addition of suffix "Annc" to the respective resource type identifier indicates the associated announced resource type. Resource types that can occur as child resources of announced resources are summarized in table 9.6.26.1-1 "Announced Resource Types".

Among the resource types listed in table 9.6.1.1-1, the following are termed "Content Sharing Resources" in oneM2M Specifications for the purpose of referring to any of those resource types:

- *container*;
- *contentInstance*;
- *flexContainer*;

- *timeSeries*;
- *timeSeriesInstance*.

Table 9.6.1.1-1: Resource Types

Resource Type	Short Description	Child Resource Types	Parent Resource Types	Clause
<i>accessControlPolicy</i>	Stores a representation of privileges. It is associated with resources that shall be accessible to entities external to the Hosting CSE. It controls "who" is allowed to do "what" and the context in which it can be used for accessing resources	<i>subscription</i>	<i>AE, AEAnn, remoteCSE, remoteCSEAnn, CSEBase</i>	9.6.2
<i>AE</i>	Stores information about the AE. It is created as a result of successful registration of an AE with the Registrar CSE	<i>subscription, container, flexContainer, group, accessControlPolicy, schedule, pollingChannelsemanticDescriptor, timeSeries</i>	<i>CSEBase</i>	9.6.5
<i>container</i>	Shares data instances among entities. Used as a mediator that buffers data exchanged between AEs and/or CSEs. The exchange of data between AEs (e.g. an AE on a Node in a field domain and the peer-AE on the infrastructure domain) is abstracted from the need to set up direct connections and allows for scenarios where both entities in the exchange do not have the same reachability schedule	<i>container, flexContainer, contentInstance, subscription, latest, oldest, semanticDescriptor</i>	<i>AE, AEAnn, container, containerAnn, remoteCSE, remoteCSEAnn, CSEBase, flexContainer, flexContainerAnn</i>	9.6.6
<i>contentInstance</i>	Represents a data instance in the <container> resource	<i>semanticDescriptor</i>	<i>Container, containerAnn</i>	9.6.7
<i>flexContainer</i>	A template which allows to define specialized (customizable) versions of containers with a flexible and lightweight structure	<i>container, flexContainer, subscription, semanticDescriptor</i>	<i>AE, AEAnn, container, containerAnn, flexContainer, flexContainerAnn, remoteCSE, remoteCSEAnn, CSEBase</i>	9.6.35
<i>CSEBase</i>	The structural root for all the resources that are residing on a CSE. Stores information about the CSE itself	<i>remoteCSE, remoteCSEAnn, node, AE, container, group, accessControlPolicy, subscription, mgmtCmd, locationPolicy, statsConfig, statsCollect, request, delivery, schedule, notificationTargetPolicy, flexContainer, timeSeries</i>	<i>None specified</i>	9.6.3

Resource Type	Short Description	Child Resource Types	Parent Resource Types	Clause
<i>delivery</i>	Forwards requests from CSE to CSE	<i>subscription</i>	<i>CSEBase</i>	9.6.11
<i>eventConfig</i>	Defines events that trigger statistics collection	<i>subscription</i>	<i>statsConfig</i>	9.6.24
<i>execInstance</i>	Contains all execution instances of the same Management Command	<i>subscription</i>	<i>mgmtCmd</i>	9.6.17
<i>fanOutPoint (V)</i>	Virtual resource containing target for group request It is used for addressing bulk operations to all the resources that belong to a group	<i>None specified</i>	<i>group</i>	9.6.14
<i>group</i>	Stores information about resources of the same type that need to be addressed as a Group. Operations addressed to a Group resource shall be executed in a bulk mode for all members belonging to the Group	<i>fanOutPoint, subscription, semanticFanOutPoint, semanticDescriptor</i>	<i>AE, AEAnnnc, remoteCSE, remoteCSEAnnnc, CSEBase</i>	9.6.13
<i>latest (V)</i>	Virtual resource that points to most recently created <i><contentInstance></i> child resource within a <i><container></i> resource	<i>None specified</i>	<i>container</i>	9.6.27
<i>locationPolicy</i>	Includes information to obtain and manage geographical location. It is only referenced within a container, the <i>contentInstances</i> of the container provide location information	<i>subscription</i>	<i>CSEBase</i>	9.6.10
<i>mgmtCmd</i>	Management Command resource represents a method to execute management procedures required by existing management protocols	<i>execInstance, subscription</i>	<i>CSEBase</i>	9.6.16
<i>mgmtObj</i>	Management Object resource represents management functions that provides an abstraction to be mapped to external management technology. It represents the node and the software installed in the node (see note)	<i>subscription, mgmtObj, schedule</i>	<i>node, mgmtObj, mgmtObjAnnnc</i>	9.6.15 Annex D
<i>m2mServiceSubscription Profile</i>	Data pertaining to the M2M Service Subscription	<i>serviceSubscribedNode, subscription</i>	<i>CSEBase</i>	9.6.19
<i>node</i>	Represents specific Node information	<i>mgmtObj, subscription, semanticDescriptor</i>	<i>CSEBase</i>	9.6.18
<i>notificationTargetMgmtPolicyRef</i>	Represents a list of notification targets and the deletion policy	<i>subscription</i>	<i>subscription</i>	9.6.31
<i>notificationTargetPolicy</i>	Represents a notification target deletion policy with pre-defined action and deletion rules	<i>subscription, policyDeletionRules</i>	<i>CSEBase</i>	9.6.32

Resource Type	Short Description	Child Resource Types	Parent Resource Types	Clause
<i>notificationTargetSelfReference (V)</i>	Virtual resource used to remove the Notification Target	<i>None specified</i>	<i>subscription</i>	9.6.34
<i>oldest (V)</i>	Virtual resource that points to first created <contentInstance> child resource within a <container> resource	<i>None specified</i>	<i>container</i>	9.6.28
<i>pollingChannel</i>	Represent a channel that can be used for a request-unreachable entity	<i>pollingChannelURI</i>	<i>remoteCSE, AE</i>	9.6.21
<i>pollingChannelURI (V)</i>	Virtual resource used to perform service layer long polling of a resource Hosting CSE by a request-unreachable entity	<i>None specified</i>	<i>pollingChannel</i>	9.6.22
<i>policyDeletionRules</i>	Represents a set of rules which is associated with notification target removal policy	<i>subscription</i>	<i>notificationTargetPolicy</i>	9.6.33
<i>remoteCSE</i>	Represents a remote CSE for which there has been a registration procedure with the registrar CSE identified by the CSEBase resource	<i>container, containerAnnc, flexContainer, flexContainerAnnc, group, groupAnnc, accessControlPolicy, accessControlPolicyAnnc, subscription, pollingChannel, schedule, timeSeries, timeSeriesAnnc, remoteCSEAnnc, nodeAnnc, AEAnnc, locationPolicyAnnc</i>	<i>CSEBase</i>	9.6.4
<i>request</i>	Expresses/access context of an issued Request	<i>subscription</i>	<i>CSEBase</i>	9.6.12
<i>schedule</i>	Contains scheduling information for delivery of messages	<i>subscription</i>	<i>subscription, remoteCSE, AE, trafficPattern</i>	9.6.9
<i>serviceSubscribedNode</i>	Node information	<i>subscription</i>	<i>m2mServiceSubscriptionProfile</i>	9.6.20
<i>statsCollect</i>	Defines triggers for the IN-CSE to collect statistics for applications	<i>subscription</i>	<i>CSEBase (in IN-CSE)</i>	9.6.25
<i>statsConfig</i>	Stores configuration of statistics for applications	<i>eventConfig, subscription</i>	<i>CSEBase (in IN-CSE)</i>	9.6.23

Resource Type	Short Description	Child Resource Types	Parent Resource Types	Clause
<i>subscription</i>	Subscription resource represents the subscription information related to a resource. Such a resource shall be a child resource for the subscribe-to resource	<i>schedule, notificationTargetSelfReference, notificationTargetMgmtPolicyRef</i>	<i>accessControlPolicy, accessControlPolicyAnnc, AE, AEAnnc, container, containerAnnc, CSEBase, delivery, eventConfig, execlInstance, group, groupAnnc, locationPolicy, locationPolicyAnnc, mgmtCmd, mgmtObj, mgmtObjAnnc, m2mServiceSubscriptionProfile, node, nodeAnnc, serviceSubscribedNode, remoteCSE, remoteCSEAnnc, request, schedule, scheduleAnnc, semanticDescriptor, semanticDescriptorAnnc, statsCollect, statsConfig, flexContainer, flexContainerAnnc, timeSeries, timeSeriesAnnc</i>	9.6.8
<i>serviceSubscribedAppRule</i>	Represents a rule that defines allowed App-ID and AE-ID combinations that are acceptable for registering an AE on a Registrar CSE	<i>subscription</i>	<i>CSEBase</i>	9.6.29
<i>semanticDescriptor</i>	Stores semantic description pertaining to a resource and potentially sub-resources.	<i>subscription</i>	<i>AE, container, contentInstance, group, node, flexContainer, timeSeries</i>	9.6.30
<i>semanticFanOutPoint</i>	Virtual resource used as target for semantic discovery aimed at a logical graph distributed over multiple <i>semanticDescriptor</i> resources, which belong to the corresponding <i>group</i> parent resource	<i>None specified</i>	<i>group</i>	9.6.14a
<i>trafficPattern</i>	Represents the communication pattern and the mobility pattern of a Field Domain Node.	<i>schedule, subscription</i>	<i>Node, AE</i>	9.6.41
<i>dynamicAuthorizationConsultation</i>	Represents consultation information used by a CSE when performing consultation-based dynamic authorization	<i>None Specified</i>	<i>AE, AEAnnc, remoteCSE, remoteCSEAnnc, CSEBase</i>	9.6.40

Resource Type	Short Description	Child Resource Types	Parent Resource Types	Clause
<i>timeSeries</i>	Stores and Shares Time Series Data instances among entities.	<i>timeSeriesInstance, subscription, semanticDescriptor</i>	<i>AE, AEAnnnc, remoteCSE, remoteCESAnnnc, CSEBase</i>	9.6.36
<i>timeSeriesInstance</i>	Represents a Time Series Data instance in the < <i>timeSeries</i> > resource	<i>None specified</i>	<i>timeSeries, timeSeriesAnnnc</i>	9.6.37
NOTE: See clause 9.6.12 for a summary of specializations of < <i>mgmtObj</i> >.				

9.6.1.2 Resource Type Specializations

9.6.1.2.1 Specializations of <mgmtObj>

Table 9.6.1.2.1-1 lists specializations of the <mgmtObj> resource type in which the *mgmtDefinition* attribute contains an enumerated value that provides further definition of the resource.

Table 9.6.1.2.1-1: <mgmtObj> Specializations

Resource specialization	Short Description	Child Resource Types	Parent Resource Types	Clause
<i>activeCmdhPolicy</i>	Provides a link to the currently active set of CMDH policies	None specified	<i>node</i>	D.12.1
<i>areaNwkDeviceInfo</i>	Provides information about the Node in the M2M Area Network	<i>subscription</i>	<i>node</i>	D.6
<i>areaNwkInfo</i>	Describes the list of Nodes attached behind the MN node and its physical or underlying relation among the nodes in the M2M Area Network	<i>subscription</i>	<i>node</i>	D.5
<i>battery</i>	Provides the power information of the node (e.g. remaining battery charge)	<i>subscription</i>	<i>node</i>	D.7
<i>cmdhBuffer</i>	Defines CMDH buffer usage limits	<i>subscription</i>	<i>cmdhPolicy</i>	D.12.8
<i>cmdhDefaults</i>	Defines CMDH default values	<i>cmdhDefEcValue</i> , <i>cmdhEcDefParamValues</i> <i>subscription</i>	<i>cmdhPolicy</i>	D.12.2
<i>cmdhEcDefParamValues</i>	Represent a specific set of default values for the CMDH related parameters	<i>subscription</i>	<i>cmdhDefaults</i>	D.12.4
<i>cmdhDefEcValue</i>	Defines a value for the Event Category parameter of an incoming request when it is not defined	<i>subscription</i>	<i>cmdhDefaults</i>	D.12.3
<i>cmdhLimits</i>	Defines limits for CMDH related parameter values	<i>subscription</i>	<i>cmdhPolicy</i>	D.12.5
<i>cmdhNetworkAccessRules</i>	Defines rules for the usage of underlying networks	<i>cmdhNwAccessRule</i> , <i>subscription</i>	<i>cmdhPolicy</i>	D.12.6
<i>cmdhNwAccessRule</i>	Defines a rule for the usage of underlying networks	<i>schedule</i> <i>subscription</i>	<i>cmdhNetworkAccessRules</i>	D.12.7
<i>cmdhPolicy</i>	A set of rules defining which CMDH parameters will be used by default	<i>cmdhDefaults</i> , <i>cmdhLimits</i> , <i>cmdhNetworkAccessRules</i> , <i>cmdhBuffer</i> , <i>subscription</i>	<i>node</i>	D.12
<i>deviceCapability</i>	Contains information about the capability supported by the Node	<i>subscription</i>	<i>node</i>	D.9
<i>deviceInfo</i>	Contains information about the identity, manufacturer and model number of the device	<i>subscription</i>	<i>node</i>	D.8
<i>eventLog</i>	Contains information about the log of events of the Node	<i>subscription</i>	<i>node</i>	D.11
<i>firmware</i>	Provides information about the firmware of the Node (e.g. name, version)	<i>subscription</i>	<i>node</i>	D.2
<i>memory</i>	Provides the memory (typically RAM) information of the node (e.g. the amount of total volatile memory)	<i>subscription</i>	<i>node</i>	D.4
<i>reboot</i>	Used to reboot or reset the Node	<i>subscription</i>	<i>node</i>	D.10
<i>software</i>	Provides information about the software of the Node	<i>subscription</i>	<i>node</i>	D.3
<i>registration</i>	To convey the service layer configuration information	<i>subscription</i>	<i>node</i>	7.1 in [9]
<i>dataCollection</i>	To convey the application configuration information	<i>subscription</i>	<i>node</i>	7.2 in [9]
<i>authenticationProfile</i>	To convey the configuration information regarding establishing mutually-authenticated secure communications	<i>subscription</i>	<i>node</i>	7.1 in [9]

Resource specialization	Short Description	Child Resource Types	Parent Resource Types	Clause
<i>myCertFileCred</i>	To configure a certificate or certificate chain	<i>subscription</i>	<i>authenticationProfile</i>	7.1 in [9]
<i>trustAnchorCred</i>	To identify a trust anchor certificate for validation of certificates	<i>subscription</i>	<i>authenticationProfile</i>	7.1 in [9]
<i>MAFClientRegCfg</i>	To convey instructions regarding the MAF Client Registration procedure	<i>subscription</i>	<i>authenticationProfile</i>	7.1 in [9]

9.6.1.2.2 Specializations of <flexContainer>

9.6.1.2.2.1 <flexContainer> for generic interworking

Generic interworking (specified in oneM2M TS-0012 [6]) provides interworking with many types of non- oneM2M area networks and their devices. It supports the interworking variant " full mapping of the semantic of the non-oneM2M data model to Mca" as indicated in clause F.2.

Generic interworking can be done for non-oneM2M systems for which no oneM2M specified interworking exists. For generic interworking the non-oneM2M data model of the non- oneM2M area network needs to be described in the form of a oneM2M compliant ontology which is derived from the oneM2M base ontology (specified in oneM2M TS-0012 [6]) and that may be available in a formal description language (e.g. OWL).

Table 9.6.1.2.2.1-1 lists specializations of the <flexContainer> resource type for generic interworking in which the *containerDefinition* attribute provides further definition of the resource.

Table 9.6.1.2.2.1-1: <flexContainer> Specializations for Generic Interworking

Resource specialization	Short Description	Child Resource Types	Parent Resource Types	Clause
<i>genericInterworkingService</i>	This resource type is used to link to a set of input- and outputDataPoints of the service and to provide the parent resource for operationInstance resources of the service	<i>genericInterworkingService</i> , <i>genericInterworkingOperationInstance</i> , <i>semanticDescriptor</i> , <i>subscription</i>	<i>AE</i> , <i>container</i> , <i>flexContainer</i> , <i>genericInterworkingService</i>	9 in [6]
<i>genericInterworkingOperationInstance</i>	This resource type is used to link to a set of input- and outputDataPoints and a set of operationInputs and operationOutputs of the operationInstance	<i>semanticDescriptor</i> , <i>subscription</i>	<i>genericInterworkingService</i>	9 in [6]

9.6.1.2.2.2 <flexContainer> for AllJoyn interworking

The following table contains the list of <flexContainer> specialization resources for oneM2M and AllJoyn interworking defined in [7]. This also summarizes parent-child relationship for each specialization resource type.

Table 9.6.1.2.2.2-1: <flexContainer> Specializations

Resource specialization	Short Description	Child Resource Types	Parent Resource Types	Clause
<i>svcObjWrapper</i>	AllJoyn service object wrapper	<i>allJoynApp</i>	<i>AE</i>	B.2 in [7]
<i>svcFwWrapper</i>	AllJoyn service framework wrapper	<i>n/a</i>	<i>AE</i>	B.3 in [7]
<i>allJoynApp</i>	AllJoyn application	<i>allJoynSvcObject</i>	<i>svcObjWrapper</i>	B.4 in [7]
<i>allJoynSvcObject</i>	AllJoyn service object	<i>allJoynInterface</i>	<i>allJoynApp</i>	B.5 in [7]
<i>allJoynInterface</i>	AllJoyn interface	<i>allJoynMethod</i> , <i>allJoynProperty</i>	<i>allJoynSvcObject</i>	B.6 in [7]
<i>allJoynMethod</i>	AllJoyn method	<i>allJoynMethodCall</i>	<i>allJoynInterface</i>	B.7 in [7]
<i>allJoynMethodCall</i>	AllJoyn method call	<i>n/a</i>	<i>allJoynMethod</i>	B.8 in [7]
<i>allJoynProperty</i>	AllJoyn property	<i>n/a</i>	<i>allJoynInterface</i>	B.9 in [7]

9.6.1.2.2.3

<flexContainer> for Home Appliance Information Model

Table 9.6.1.2.2.3-1 contains the list of <flexContainer> specialization resources for oneM2M Home Appliance Information Model (HAIM) defined in [8]. This also summarizes parent-child relationship for each specialization resource type.

Table 9.6.1.2.2.3-1: <flexContainer> Specializations

Resource specialization	Short Description	Child Resource Types	Parent Resource Types	Clause
<i>alarmSpeaker</i>	HAIM ModuleClass	<i>subscription</i>	<i>n/a</i>	5.3.1 in [8]
<i>audioVideoInput</i>	HAIM ModuleClass	<i>subscription</i>	<i>deviceTelevision</i>	5.3.2 in [8]
<i>audioVolume</i>	HAIM ModuleClass	<i>upVolume,</i> <i>downVolume</i> <i>subscription</i>	<i>deviceTelevision</i>	5.3.3 in [8]
<i>battery</i>	HAIM ModuleClass	<i>subscription</i>	<i>deviceElectricVehicleCharger,</i> <i>deviceRobotCleaner,</i> <i>deviceStorageBattery</i>	5.3.4 in [8]
<i>binarySwitch</i>	HAIM ModuleClass	<i>toggle, subscription</i>	<i>deviceAirConditioner,</i> <i>deviceClothesWasher,</i> <i>deviceElectricVehicleCharger,</i> <i>deviceLight,</i> <i>deviceMicrogeneration,</i> <i>deviceOven,</i> <i>deviceRefrigerator,</i> <i>deviceRobotCleaner,</i> <i>deviceSmartElectricMeter,</i> <i>deviceStorageBattery,</i> <i>deviceTelevision,</i> <i>deviceWaterHeater</i>	5.3.5 in [8]
<i>bioElectricalImpedanceAnalysis</i>	HAIM ModuleClass	<i>subscription</i>	<i>n/a</i>	5.3.6 in [8]
<i>boiler</i>	HAIM ModuleClass	<i>subscription</i>	<i>deviceWaterHeater</i>	5.3.7 in [8]
<i>brightness</i>	HAIM ModuleClass	<i>subscription</i>	<i>deviceLight</i>	5.3.8 in [8]
<i>clock</i>	HAIM ModuleClass	<i>subscription</i>	<i>deviceSmartElectricMeter,</i> <i>deviceWaterHeater</i>	5.3.9 in [8]
<i>colour</i>	HAIM ModuleClass	<i>subscription</i>	<i>deviceLight</i>	5.3.10 in [8]
<i>colourSaturation</i>	HAIM ModuleClass	<i>subscription</i>	<i>deviceLight</i>	5.3.11 in [8]
<i>doorStatus</i>	HAIM ModuleClass	<i>subscription</i>	<i>deviceRefrigerator</i>	5.3.12 in [8]
<i>electricVehicleConnector</i>	HAIM ModuleClass	<i>subscription</i>	<i>deviceElectricVehicleCharger</i>	5.3.13 in [8]
<i>energyConsumption</i>	HAIM ModuleClass	<i>subscription</i>	<i>deviceSmartElectricMeter</i>	5.3.14 in [8]
<i>energyGeneration</i>	HAIM ModuleClass	<i>subscription</i>	<i>deviceMicrogeneration,</i> <i>deviceSmartElectricMeter</i>	5.3.15 in [8]
<i>faultDetection</i>	HAIM ModuleClass	<i>subscription</i>	<i>deviceElectricVehicleCharger,</i> <i>deviceLight</i> <i>deviceMicrogeneration,</i> <i>deviceSmartElectricMeter,</i> <i>deviceStorageBattery,</i> <i>deviceWaterHeater</i>	5.3.16 in [8]
<i>height</i>	HAIM ModuleClass	<i>subscription</i>	<i>n/a</i>	5.3.17 in [8]
<i>hotWaterSupply</i>	HAIM ModuleClass	<i>subscription</i>	<i>deviceWaterHeater</i>	5.3.18 in [8]
<i>keypad</i>	HAIM ModuleClass	<i>subscription</i>	<i>n/a</i>	5.3.19 in [8]
<i>motionSensor</i>	HAIM ModuleClass	<i>subscription</i>	<i>n/a</i>	5.3.20 in [8]
<i>oximeter</i>	HAIM ModuleClass	<i>subscription</i>	<i>n/a</i>	5.3.21 in [8]
<i>powerSave</i>	HAIM ModuleClass	<i>subscription</i>	<i>deviceRefrigerator</i>	5.3.22 in [8]
<i>pushButton</i>	HAIM ModuleClass	<i>subscription</i>	<i>n/a</i>	5.3.23 in [8]
<i>recorder</i>	HAIM ModuleClass	<i>subscription</i>	<i>n/a</i>	5.3.24 in [8]
<i>refrigeration</i>	HAIM ModuleClass	<i>subscription</i>	<i>deviceRefrigerator</i>	5.3.25 in [8]
<i>relativeHumidity</i>	HAIM ModuleClass	<i>subscription</i>	<i>n/a</i>	5.3.26 in [8]
<i>rinseLevel</i>	HAIM ModuleClass	<i>subscription</i>	<i>deviceClothesWasher</i>	5.3.27 in [8]
<i>runMode</i>	HAIM ModuleClass	<i>subscription</i>	<i>deviceAirConditioner,</i> <i>deviceClothesWasher,</i> <i>deviceElectricVehicleCharger</i>	5.3.28 in [8]

Resource specialization	Short Description	Child Resource Types	Parent Resource Types	Clause
			<i>arger, deviceLight, deviceMicrogeneration, deviceOven, deviceRobotCleaner, deviceSmartElectricMeter, deviceStorageBattery, deviceThermostat, deviceWaterHeater</i>	
<i>signalStrength</i>	HAIM ModuleClass	<i>subscription</i>	<i>n/a</i>	5.3.29 in [8]
<i>smokeSensor</i>	HAIM ModuleClass	<i>subscription</i>	<i>n/a</i>	5.3.30 in [8]
<i>spinLevel</i>	HAIM ModuleClass	<i>subscription</i>	<i>deviceClothesWasher</i>	5.3.31 in [8]
<i>televisionChannel</i>	HAIM ModuleClass	<i>upChannel, downChannel, subscription</i>	<i>deviceTelevision</i>	5.3.32 in [8]
<i>temperature</i>	HAIM ModuleClass	<i>subscription</i>	<i>deviceAirConditioner, deviceClothesWasher, deviceOven, deviceRefrigerator, deviceThermostat</i>	5.3.33 in [8]
<i>temperatureAlarm</i>	HAIM ModuleClass	<i>subscription</i>	<i>n/a</i>	5.3.34 in [8]
<i>timer</i>	HAIM ModuleClass	<i>activateClockTimer, deactivateClockTimer, subscription</i>	<i>deviceAirConditioner, deviceClothesWasher, deviceOven, deviceRobotCleaner, deviceThermostat</i>	5.3.35 in [8]
<i>turbo</i>	HAIM ModuleClass	<i>subscription</i>	<i>deviceAirConditioner</i>	5.3.36 in [8]
<i>waterFlow</i>	HAIM ModuleClass	<i>subscription</i>	<i>deviceClothesWasher</i>	5.3.37 in [8]
<i>waterLevel</i>	HAIM ModuleClass	<i>subscription</i>	<i>deviceClothesWasher</i>	5.3.38 in [8]
<i>waterSensor</i>	HAIM ModuleClass	<i>subscription</i>	<i>n/a</i>	5.3.39 in [8]
<i>weight</i>	HAIM ModuleClass	<i>subscription</i>	<i>n/a</i>	5.3.40 in [8]
<i>wind</i>	HAIM ModuleClass	<i>subscription</i>	<i>deviceAirConditioner</i>	5.3.41 in [8]
<i>deviceAirConditioner</i>	HAIM Device;	<i>binarySwitch, runMode, temperature, timer, turbo, wind, subscription</i>	AE	5.4.1 in [8]
<i>deviceClothesWasher</i>	HAIM Device;	<i>binarySwitch, timer, runMode, temperature, waterLevel, rinseLevel, waterFlow, spinLevel, subscription</i>	AE	5.4.2 in [8]
<i>deviceElectricVehicleCharger</i>	HAIM Device;	<i>faultDetection, binarySwitch, runMode, battery, electricVehicleConnector, subscription</i>	AE	5.4.3 in [8]
<i>deviceLight</i>	HAIM Device;	<i>faultDetection, binarySwitch, runMode, colour, colourSaturation, brightness, subscription</i>	AE	5.4.4 in [8]
<i>deviceMicrogeneration</i>	HAIM Device;	<i>faultDetection, binarySwitch, runMode, energyGeneration, subscription</i>	AE	5.4.5 in [8]
<i>deviceOven</i>	HAIM Device;	<i>binarySwitch, runMode, timer, temperature, subscription</i>	AE	5.4.6 in [8]

Resource specialization	Short Description	Child Resource Types	Parent Resource Types	Clause
<i>deviceRefrigerator</i>	HAIM Device;	<i>binarySwitch, powerSave, doorStatus, temperature, refrigeration, subscription</i>	AE	5.4.7 in [8]
<i>deviceRobotCleaner</i>	HAIM Device;	<i>binarySwitch, runMode, battery, timer, subscription</i>	AE	5.4.8 in [8]
<i>deviceSmartElectricMeter</i>	HAIM Device;	<i>faultDetection, binarySwitch, runMode, clock, energyConsumption, energyGeneration, subscription</i>	AE	5.4.9 in [8]
<i>deviceStorageBattery</i>	HAIM Device;	<i>faultDetection, binarySwitch, runMode, battery, subscription</i>	AE	5.4.10 in [8]
<i>deviceTelevision</i>	HAIM Device;	<i>binarySwitch, audioVolume, televisionChannel, audioVideoInput, subscription</i>	AE	5.4.11 in [8]
<i>deviceThermostat</i>	HAIM Device;	<i>runMode, timer, temperature, subscription</i>	AE	5.4.12 in [8]
<i>deviceWaterHeater</i>	HAIM Device;	<i>faultDetection, binarySwitch, runMode, clock, boiler, hotWaterSupply, subscription</i>	AE	5.4.13 in [8]

9.6.1.3 Commonly Used Attributes

9.6.1.3.0 Overview

Some attributes described herein are present in all *<resourceTypes>*. Such attributes are described in clause 9.6.1.3.1 once in order to avoid duplicating the description for every *<resourceType>* and are referred to as "universal attributes".

Some other attributes described herein are commonly used in multiple, but not all, *<resourceTypes>*. Such attributes are described in clause 9.6.1.3.2 once in order to avoid duplicating the description for every *<resourceType>* that contains it and are referred to as "common attributes".

Remaining attributes are described in the clause specific for that resource type.

9.6.1.3.1 Universal attributes

The following attributes are universal to all resource types which are normal, not virtual or announced. Universal attributes for announced resource types are independently defined in clause 9.6.26.2.

Table 9.6.1.3.1-1: Universal Attributes

Attribute Name	Description
<i>resourceType</i>	Resource Type. This Read Only (assigned at creation time, and then cannot be changed) attribute identifies the type of the resource as specified in clause 9.6. Each resource shall have a <i>resourceType</i> attribute.
<i>resourceID</i>	This attribute is an identifier for the resource that is used for 'non-hierarchical addressing method', i.e. this attribute shall contain the 'Unstructured-CSE-relative-Resource-ID' format of a resource ID as defined in table 7.2-1. This attribute shall be provided by the Hosting CSE when it accepts a resource creation procedure. The Hosting CSE shall assign a <i>resourceID</i> which is unique in that CSE.
<i>resourceName</i>	This attribute is the name for the resource that is used for 'hierarchical addressing method' to represent the parent-child relationships of resources. See clause 7.2 for more details. This attribute may be provided by the resource creator. The Hosting CSE shall use a provided <i>resourceName</i> as long as it does not already exist among child resources of the targeted parent resource. If the <i>resourceName</i> already exists, the Hosting CSE shall reject the request and return an error to the Originator. The Hosting CSE shall assign a <i>resourceName</i> if one is not provided by the resource creator.
<i>parentID</i>	This attribute is the <i>resourceID</i> of the parent of this resource. The value of this attribute shall be NULL for the <CSEBase> resource type.
<i>creationTime</i>	Time/date of creation of the resource. This attribute is mandatory for all resources and the value is assigned by the system at the time when the resource is locally created. Such an attribute cannot be changed.
<i>lastModifiedTime</i>	Last modification time/date of the resource. The <i>lastModifiedTime</i> value is set by the Hosting CSE when the resource is created, and the <i>lastModifiedTime</i> value is updated when the resource is updated.

9.6.1.3.2 Common attributes

The following attributes are commonly used in multiple, but not all, resource types which are normal, not virtual or announced. Common attributes for announced resource types are independently defined in clause 9.6.26.3.

NOTE: The list of attributes in table 9.6.1.3.2-1 is not exhaustive.

Table 9.6.1.3.2-1: Common Attributes

Attribute Name	Description
<p><i>accessControlPolicyIDs</i></p>	<p>The attribute contains a list of identifiers for <accessControlPolicy> resources. The privileges defined in the <accessControlPolicy> resources that are referenced determine who is allowed to access the resource containing this attribute for a specific purpose (e.g. Retrieve, Update, Delete, etc.).</p> <p>For an Update or Delete operation to a resource, the update or delete of the <i>accessControlPolicyIDs</i> attribute, if applicable, shall be performed prior to the update or delete of any other attributes of the resource.</p> <p>To update this attribute, a Hosting CSE shall check whether an Originator has Update privilege in any <i>selfPrivileges</i>, regardless of <i>privileges</i>, of the <accessControlPolicy> resources which this attribute originally references.</p> <p>After successful update of the <i>accessControlPolicyIDs</i> attribute, resource access checking for other attributes to be updated shall use the new <i>privileges</i> defined in the <accessControlPolicy> resource(s) that are referenced by the newly updated <i>accessControlPolicyIDs</i> attribute.</p> <p>Similarly, to delete this attribute, a Hosting CSE shall check whether an Originator has Delete privilege in any <i>selfPrivileges</i>, regardless of <i>privileges</i>, of the <accessControlPolicy> resources which this attribute originally references.</p> <p>After successful deletion of the <i>accessControlPolicyIDs</i> attribute, resource access checking for other attributes to be deleted shall use the default access privileges as described in the following paragraphs.</p> <p>If a resource type does not have an <i>accessControlPolicyIDs</i> attribute definition, then the <i>accessControlPolicyIDs</i> for that resource is governed in a different way, for example, the <i>accessControlPolicy</i> associated with the parent may apply to a child resource that does not have an <i>accessControlPolicyIDs</i> attribute definition, or the privileges for access are fixed by the system. Refer to the corresponding resource type definitions and procedures to see how access control is handled in such cases.</p> <p>If a resource type does have an <i>accessControlPolicyIDs</i> attribute definition, but the (optional) <i>accessControlPolicyIDs</i> attribute is not set, or it is set to a value that does not correspond to a valid, existing <accessControlPolicy> resource, or it refers to an <accessControlPolicy> resource that is not reachable (e.g. because it is located on a remote CSE that is offline or not reachable), then the Hosting CSE shall support a default access privilege. This default shall provide access privileges to only the creator of the resource. The Hosting CSE shall keep track of the creator of the resource even if the resource does not support a creator attribute. The default access privilege shall grant the creator unrestricted access to the resource, i.e. it shall include all possible operations for that resource. All other entities shall be denied access by default..</p> <p>All resources are accessible if and only if the privileges (i.e. configured as <i>privileges</i> or <i>selfPrivileges</i> attribute of <accessControlPolicy> resource) allow it, therefore all resources shall have an associated <i>accessControlPolicyIDs</i> attribute, either explicitly (setting the attribute in the resource itself) or implicitly (either by using the parent privileges or the system default policies). Which means that the system shall provide default access privileges in case that the Originator does not provide a specific <i>accessControlPolicyIDs</i> during the creation of the resource.</p>

Attribute Name	Description
<i>expirationTime</i>	<p>Time/date after which the resource will be deleted by the Hosting CSE. This attribute can be provided by the Originator, and in such a case it will be regarded as a hint to the Hosting CSE on the lifetime of the resource. The Hosting CSE shall configure the <i>expirationTime</i> value. If the Hosting CSE configures the new <i>expirationTime</i> attribute value rather than the Originator suggested value, the new value can be sent back to the Originator depending on the Result Content value.</p> <p>The lifetime of the resource can be extended by providing a new value for this attribute in an UPDATE operation. Or by deleting the attribute value, e.g. by updating the attribute with NULL when doing a full UPDATE, in which case the Hosting CSE can decide on a new value.</p> <p>If the Originator does not provide a value in the CREATE operation the system shall assign an appropriate value depending on its local policies and/or M2M service subscription agreements.</p> <p>A resource is known as 'obsolete' when the resource contains the attribute "expirationTime" and the lifetime of this resource has reached the value of this attribute. If the 'obsolete' resource had a reference to an Application Entity Resource ID, the Hosting CSE shall send a NOTIFY request to the IN-CSE, requesting to delete the entry from the <AEEContactList> resource.</p>
<i>stateTag</i>	<p>An incremental counter of modification on the resource. When a resource is created, this counter is set to 0, and it will be incremented on every modification of the resource (see notes 1 and 2).</p>
<i>announceTo</i>	<p>This attribute may be included in a CREATE or UPDATE Request in which case it contains a list of addresses/CSE-IDs where the resource is to be announced. For the case that CSE-IDs are provided, the announced-to CSE shall decide the location of the announced resources based on the rules described in clause 9.6.26.</p> <p>For the original resource, this attribute shall only be present if it has been successfully announced to other CSEs. This attribute maintains the list of the resource addresses to the successfully announced resources. Updates on this attribute will trigger new resource announcement or de-announcement.</p> <p>If <i>announceTo</i> attribute includes resource address(s), the present document does not provide any means for validating these address(s) for announcement purposes. It is the responsibility of the Hosting-CSE referenced by the resource address(s) to validate the access privileges of the originator of the Request that triggers the announcement.</p>
<i>announcedAttribute</i>	<p>This attributes shall only be present at the original resource if some Optional Announced (OA) type attributes have been announced to other CSEs. This attribute maintains the list of the announced Optional Attributes (OA type attributes) in the original resource. Updates to this attribute will trigger new attribute announcement if a new attribute is added or de-announcement if the existing attribute is removed.</p>
<i>labels</i>	<p>Tokens used to add meta-information to resources.</p> <p>This attribute is optional.</p> <p>The value of the <i>labels</i> attribute is a list of individual labels, each of them being:</p> <ul style="list-style-type: none"> - A standalone label-key, used as a simple "tag", that can be used for example for discovery purposes when looking for particular resources that one can "tag" using that label-key. <p>The list of allowed characters in a label and separator characters is defined in [3], clause 6.3.3.</p>
<i>e2eSecInfo</i>	<p>Present in a resource representing an AE or CSE. Indicates the end-to-end security capabilities supported by the AE or CSE. May indicate supported end-to-end security frameworks. May also contains a certificate or credential identifier used by the AE or CSE. May include random values for use in end-to-end security protocols. The details of this attributes are described in oneM2M TS-0003 [2].</p> <p>This attribute is optional and if not present it means that the represented entity does not support oneM2M end-to-end security procedures.</p>
<i>dynamicAuthorizationConsultationIDs</i>	<p>This attribute contains a list of identifiers of <dynamicAuthorizationConsultation> resources. The information defined in a <dynamicAuthorizationConsultation> resource is used by a CSE for initiating consultation-based dynamic authorization requests.</p> <p>Consultation-based dynamic authorization is only performed for a targeted resource if and only if it is linked to an enabled <dynamicAuthorizationConsultation> resource.</p>

Attribute Name	Description
	If the attribute is not set or has a value that does not correspond to a valid <dynamicAuthorizationConsultation> resource(s), or it refers to an <dynamicAuthorizationConsultation> resource(s) that is not reachable, then the dynamicAuthorizationConsultationIDs associated with the parent may apply to the child resource if present, or a system default <dynamicAuthorizationConsultation> may apply if present.
creator	The AE-ID or CSE-ID of the entity which created the resource containing this attribute.
NOTE 1:	In order to enable detection of overflow, the counter needs to be capable of expressing sufficiently long numbers.
NOTE 2:	This attribute has the scope to allow identifying changes in resources within a time interval that is lower than the one supported by the attribute lastModifiedTime (e.g. less than a second or millisecond). This attribute can also be used to avoid race conditions in case of competing modifications.

9.6.2 Resource Type *accessControlPolicy*

9.6.2.0 Introduction

The Access Control Policies (ACPs) shall be used by the CSE to control access to the resources as specified in the present document and in oneM2M TS-0003 [2].

The ACP is designed to fit different access control models such as access control lists, role or attribute based access control.

The <accessControlPolicy> resource is comprised of *privileges* and *selfPrivileges* attributes which represent a set of access control rules defining which entities (defined as *accessControlOriginators*) have the privilege to perform certain operations (defined as *accessControlOperations*) within specified contexts (defined as *accessControlContexts*) and are used by the CSEs in making Access Decision to all or specific parts of the targeted resource(defined as *accessControlObjectDetails*).

In a privilege, each access control rule defines which AE/CSE is allowed for which operation. So for sets of access control rules an operation is permitted if it is permitted by one or more access control rules in the set.

For a resource that is not of <accessControlPolicy> resource type, the common attribute *accessControlPolicyIDs* for such resources (defined in table 9.6.1.3.2-1) contains a list of identifiers which link that resource to <accessControlPolicy> resources. The CSE Access Decision for such a resource shall follow the evaluation of the set of access control rules expressed by the *privileges* attributes defined in the <accessControlPolicy> resources.

The *selfPrivileges* attribute shall represent the set of access control rules for the <accessControlPolicy> resource itself.

The CSE Access Decision for <accessControlPolicy> resource shall follow the evaluation of the set of access control rules expressed by the *selfPrivileges* attributes defined in the <accessControlPolicy> resource itself.

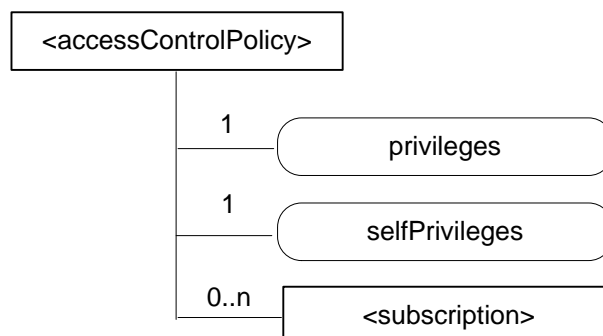

Figure 9.6.2.0-1: Structure of <accessControlPolicy> resource

The <accessControlPolicy> resource shall contain the child resource specified in table 9.6.2.0-1.

Table 9.6.2.0-1: Child resources of <accessControlPolicy> resource

Child Resources of <accessControlPolicy>	Child Resource Type	Multiplicity	Description	<accessControlPolicyAnnnc> Child Resource Types
[variable]	<subscription>	0..n	See clause 9.6.8	<subscription>

The <accessControlPolicy> resource shall contain the attributes specified in table 9.6.2.0-2.

Table 9.6.2.0-2: Attributes of <accessControlPolicy> resource

Attributes of <accessControlPolicy>	Multiplicity	RW/RO/WO	Description	<accessControlPolicyAnnnc> Attributes
resourceType	1	RO	See clause 9.6.1.3.	NA
resourceID	1	RO	See clause 9.6.1.3.	NA
resourceName	1	WO	See clause 9.6.1.3.	NA
parentID	1	RO	See clause 9.6.1.3.	NA
expirationTime	1	RW	See clause 9.6.1.3.	MA
labels	0..1(L)	RW	See clause 9.6.1.3.	MA
creationTime	1	RO	See clause 9.6.1.3.	NA
lastModifiedTime	1	RO	See clause 9.6.1.3.	NA
announceTo	0..1 (L)	RW	See clause 9.6.1.3.	NA
announcedAttribute	0..1 (L)	RW	See clause 9.6.1.3.	NA
privileges	1	RW	A set of access control rules that applies to resources referencing this <accessControlPolicy> resource using the accessControlPolicyID attribute.	MA
selfPrivileges	1	RW	A set of access control rules that apply to the <accessControlPolicy> resource itself and accessControlPolicyIDs attribute of any other resource which is linked to this <accessControlPolicy> resource.	MA

The set of access control rules represented in *privileges* and *selfPrivileges* attributes are comprised of 4-tuples (*accessControlOriginators*, *accessControlContexts*, *accessControlOperations*, *accessControlObjectDetails*) with parameters shown in table 9.6.2.0-3 which are further described in the following clauses.

If the *privileges* attribute contains no 4-tuples then this represents an empty set of the access control rules.

The *selfPrivileges* attribute shall contain at least one tuple.

The CSE access granting mechanism shall follow the procedure described in oneM2M TS-0003 [2] in clause 7.1 (Access Control Mechanism).

Table 9.6.2.0-3: Parameters in access-control-rule-tuples

Name	Description
<i>accessControlOriginators</i>	See clause 9.6.2.1
<i>accessControlContexts</i>	See clause 9.6.2.2
<i>accessControlOperations</i>	See clause 9.6.2.3
<i>accessControlObjectDetails</i>	See clause 9.6.2.4
<i>accessControlAuthenticationFlag</i>	See clause 9.6.2.5

9.6.2.1 accessControlOriginators

The *accessControlOriginators* is a mandatory parameter in an access-control-rule-tuple. It represents the set of Originators that shall be allowed to use this access control rule. The set of Originators is described as a list of parameters, where the types of the parameter can vary within the list. Table 9.6.2.1-1 describes the supported types of parameters in *accessControlOriginators*. The following Originator privilege types shall be considered for access control policy check by the CSE.

Table 9.6.2.1-1: Types of Parameters in *accessControlOriginators*

Name	Description
<i>domain</i>	A SP domain or SP sub-domain
<i>originatorID</i>	CSE-ID, AE-ID or the resource-ID of a <group> resource that contains the AE or CSE that represents the Originator
<i>all</i>	Any Originators are allowed to access the resource within the <i>accessControlOriginators</i> constraints
<i>Role-ID</i>	A Role Identifier as defined in clause 7.1.14

When the *originatorID* is the resource-ID of a <group> resource which contains <AE> or <remoteCSE> as member, the Hosting CSE of the resource shall check if the originator of the request matches one of the members in the memberIDs attribute of the <group> resource (e.g. by retrieving the <group> resource). If the <group> resource cannot be retrieved or doesn't exist, the request shall be rejected.

9.6.2.2 *accessControlContexts*

The *accessControlContexts* is an optional parameter in an access-control-rule-tuple that contains a list, where each element of the list, when present, represents a context that is permitted to use this access control rule. Each request context is described by a set of parameters, where the types of the parameters can vary within the set. Table 9.6.2.2-1 describes the supported types of parameters in *accessControlContexts*.

The following Originator *accessControlContexts* shall be considered for access control policy check by the CSE.

Table 9.6.2.2-1: Types of Parameters in *accessControlContexts*

Name	Description
<i>accessControlTimeWindow</i>	Represents a time window constraint which is compared against the time that the request is received at the Hosting CSE.
<i>accessControlLocationRegion</i>	Represents a location region constraint which is compared against the location of the Originator of the request.
<i>accessControlIPAddress</i>	Represents an IP address constraint or IP address block constraint which is compared against the IP address of the Originator of the request.

9.6.2.3 *accessControlOperations*

The *accessControlOperations* is a mandatory parameter in an access-control-rule-tuple that represents the set of operations that are authorized using this access control rule. Table 9.6.2.3-1 describes the supported set of operations that are authorized by *accessControlOperations*.

The following *accessControlOperations* shall be considered for access control policy check by the CSE.

Table 9.6.2.3-1: Types of parameters in *accessControlOperations*

Name	Description
RETRIEVE	Privilege to retrieve the content of an addressed resource
CREATE	Privilege to create a child resource
UPDATE	Privilege to update the content of an addressed resource
DELETE	Privilege to delete an addressed resource
DISCOVER	Privilege to discover the resource
NOTIFY	Privilege to receive a notification

9.6.2.4 accessControlObjectDetails

The *accessControlObjectDetails* is an optional parameter of an access control rule. It specifies a subset of child resource types of the targeted resource to which the access control rule applies. If an access control rule includes *accessControlObjectDetails*, then *childResourceType* shall be specified. An access control rule which does not include any *accessControlObjectDetails* parameters applies to the child resource types of the target resource. The *accessControlObjectDetails* parameter shall consist of the elements listed in table 9.6.2.4-1. Child resource types listed in the *childResourceType* component are subject of access control for the Create operation only. Once a child resource is created, the Access Control Policies assigned directly to it apply. The *resourceType* and *specialization* element are optional. If either the *resourceType* or *specialization* element is present in *accessControlObjectDetails*, the CSE shall match the type of resource or specialization of the targeted resource with the value specified in the *resourceType* or *specialization* element. Further checking of *childResourceType* shall be done only if the *resourceType* or *specialization* match occurs. However, if the *resourceType* and *specialization* elements are not provided, only *childResourceType* match shall be performed.

Table 9.6.2.4-1: Types of Parameters in *accessControlObjectDetails*

Name	Description
<i>resourceType</i>	Identifier of the resource type to which this access control rule applies.
<i>specialization</i>	When the <i>resourceType</i> is <i>mgmtObj</i> or <i>flexContainer</i> , the identifier of the specialization as defined by <i>mgmtDefinition</i> or <i>containerDefinition</i> attribute, respectively, shall be specified.
<i>childResourceType</i>	List of child resource types and/or the identifier of the specialization. The identifier of the specialization shall be specified when the <i>resourceType</i> is <i>mgmtObj</i> or <i>flexContainer</i> .

9.6.2.5 accessControlAuthenticationFlag

The *accessControlAuthenticationFlag* is an optional parameter in an access-control-rule-tuple: if the value is TRUE, then the access control rule applies only if the Originator is considered to be authenticated by the Hosting CSE; if the value is FALSE, then the access control rule applies whether or not the Originator is considered to be authenticated by the Hosting CSE. Clause 7.1.2 in oneM2M TS-0003 [2] describes the criteria used to determine if the Originator is considered to be authenticated by the Hosting CSE.

If the *accessControlAuthenticationFlag* parameter is not present, then the value is assumed to be FALSE.

9.6.3 Resource Type CSEBase

A *<CSEBase>* resource shall represent a CSE. The *<CSEBase>* resource shall be the root for all resources that are residing in the CSE.

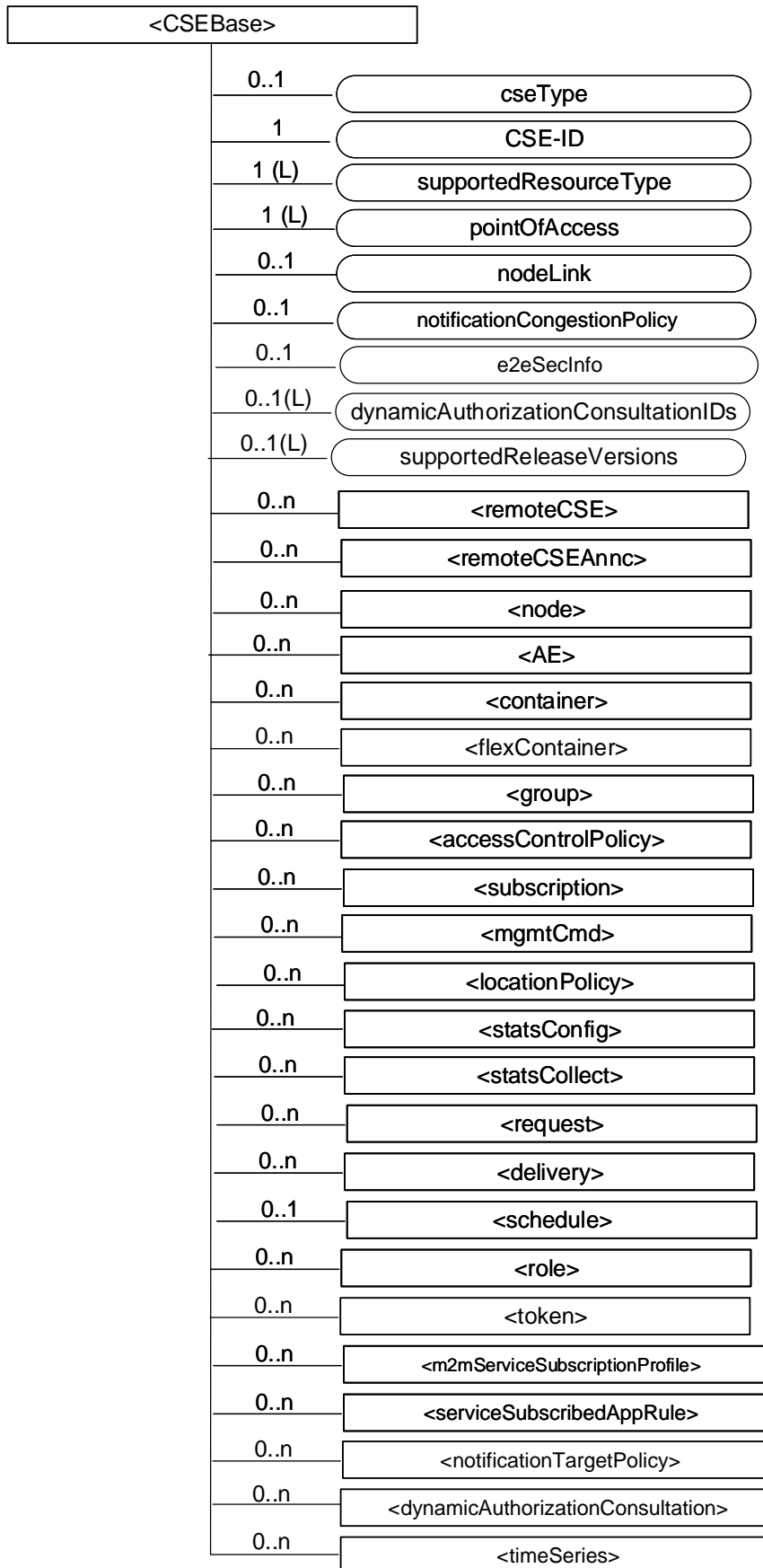

Figure 9.6.3-1: Structure of <CSEBase> resource

Figure 9.6.3-1 does not show the child announce resource types defined in table 9.6.3-2.

The *<CSEBase>* resource shall contain the child resources specified in table 9.6.3-1.

Table 9.6.3-1: Child resources of *<CSEBase>* resource

Child Resources of <i><CSEBase></i>	Child Resource Type	Multiplicity	Description
[variable]	<i><remoteCSE></i>	0..n	See clause 9.6.4
[variable]	<i><remoteCSEAnnc></i>	0..n	Announced variant of <i><remoteCSE></i> . Resource with CSE-specific information for a CSE that announced itself to another CSE with which it does not have a registration relationship.
[variable]	<i><node></i>	0..n	See clause 9.6.18
[variable]	<i><AE></i>	0..n	See clause 9.6.5
[variable]	<i><container></i>	0..n	See clause 9.6.6
[variable]	<i><flexContainer></i>	0..n	See clause 9.6.35
[variable]	<i><group></i>	0..n	See clause 9.6.13
[variable]	<i><accessControlPolicy></i>	0..n	See clause 9.6.2
[variable]	<i><subscription></i>	0..n	See clause 9.6.8
[variable]	<i><mgmtCmd></i>	0..n	See clause 9.6.16
[variable]	<i><locationPolicy></i>	0..n	See clause 9.6.10
[variable]	<i><statsConfig></i>	0..n	See clause 9.6.23
[variable]	<i><statsCollect></i>	0..n	See clause 9.6.25
[variable]	<i><request></i>	0..n	See clause 9.6.12
[variable]	<i><delivery></i>	0..n	See clause 9.6.11
[variable]	<i><schedule></i>	0..1	This resource defines the reachability schedule information of the entity. The absence of this resource implies the entity is always reachable. See clause 9.6.9
[variable]	<i><role></i>	0..n	See clause 9.6.38
[variable]	<i><token></i>	0..n	See clause 9.6.39
[variable]	<i><m2mServiceSubscriptionProfile></i>	0..n	See clause 9.6.19
[variable]	<i><serviceSubscribedAppRule></i>	0..n	See clause 9.6.29
[variable]	<i><notificationTargetPolicy></i>	0..n	See clause 9.6.32
[variable]	<i><dynamicAuthorizationConsultation></i>	0..n	See clause 9.6.40
[variable]	<i><timeSeries></i>	0..n	See clause 9.6.36

An instance of a *<remoteCSEAnnc>* resource shall be created as a child of a *<CSEBase>* resource when an Originator CSE of an announcement request (i.e. original resource Hosting CSE) and a targeted Hosting CSE of an announced resource (i.e. announced resource Hosting CSE) have no registration relationship (e.g. the Originator CSE has not created *<remoteCSE>* resource on the Hosting CSE), see clause 9.6.26.

The <CSEBase> resource shall contain the attributes specified in table 9.6.3-2.

Table 9.6.3-2: Attributes of <CSEBase> resource

Attributes of <CSEBase>	Multiplicity	RW/RO/WO	Description
<i>resourceType</i>	1	RO	See clause 9.6.1.3.
<i>resourceID</i>	1	RO	See clause 9.6.1.3.
<i>resourceName</i>	1	RO	See clause 9.6.1.3.
<i>parentID</i>	1	RO	See clause 9.6.1.3. Shall be NULL.
<i>creationTime</i>	1	RO	See clause 9.6.1.3.
<i>lastModifiedTime</i>	1	RO	See clause 9.6.1.3.
<i>accessControlPolicyIDs</i>	0..1 (L)	RO	See clause 9.6.1.3.
<i>labels</i>	0..1 (L)	RO	See clause 9.6.1.3.
<i>dynamicAuthorizationConsultationIDs</i>	0..1 (L)	RO	See clause 9.6.1.3.
<i>cseType</i>	0..1	RO	Indicates the type of CSE represented by the created resource: <ul style="list-style-type: none"> • Mandatory for an IN-CSE, hence multiplicity (1). • Its presence is subject to SP configuration in case of an ASN-CSE or a MN-CSE.
<i>CSE-ID</i>	1	RO	The CSE identifier in SP-relative CSE-ID format (clause 7.2).
<i>supportedResourceType</i>	1 (L)	RO	List of the resource types which are supported in the CSE. This attribute contains subset of resource types listed in clause 9.2.
<i>pointOfAccess</i>	1 (L)	RO	Represents the list of physical addresses to be used by remote CSEs to connect to this CSE (e.g. IP address, FQDN). This attribute is exposed to its Registree.
<i>nodeLink</i>	0..1	RO	The <i>resource identifier</i> of a <node> resource that stores the node specific information of the node on which the CSE represented by this <CSEBase> resource resides.
<i>notificationCongestionPolicy</i>	0..1	RO	This attribute applies to CSEs generating subscription notifications. It specifies the rule which is applied when the storage of notifications for each subscriber (an AE or CSE) reaches the maximum storage limit for notifications for that subscriber. E.g. Delete stored notifications of lower <i>notificationStoragePriority</i> to make space for new notifications of higher <i>notificationStoragePriority</i> , or delete stored notifications of older <i>creationTime</i> to make space for new notifications when all notifications are of the same <i>notificationStoragePriority</i> .
<i>e2eSecInfo</i>	0..1	RO	See clause 9.6.1.3.
<i>supportedReleaseVersions</i>	0..1 (L)	RO	List of oneM2M release versions which are supported by the CSE. Starting with Release 2, this attribute is mandatory for a CSE. For CSEs compliant to older releases, this attribute is optional. For CSEs that do not include this attribute, the default release version shall be Release 1.

9.6.4 Resource Type *remoteCSE*

A <remoteCSE> resource shall represent a Registree CSE that is registered to the Registrar CSE. <remoteCSE> resources shall be located directly under the <CSEBase> resource of Registrar CSE.

Similarly <remoteCSE> resource shall also represent a Registrar CSE. <remoteCSE> resource shall be located directly under the <CSEBase> resource of Registree CSE.

For example, when CSE1 (Registree CSE) registers with CSE2 (Registrar CSE), there will be two <remoteCSE> resources created: one in CSE1: <CSEBase1>/<remoteCSE2> and one in CSE2: <CSEBase2>/<remoteCSE1>.

Note that the creation of the two resources does not imply mutual registration. The <CSEBase1>/<remoteCSE2> does not mean CSE2 registered with CSE1 in the example above.

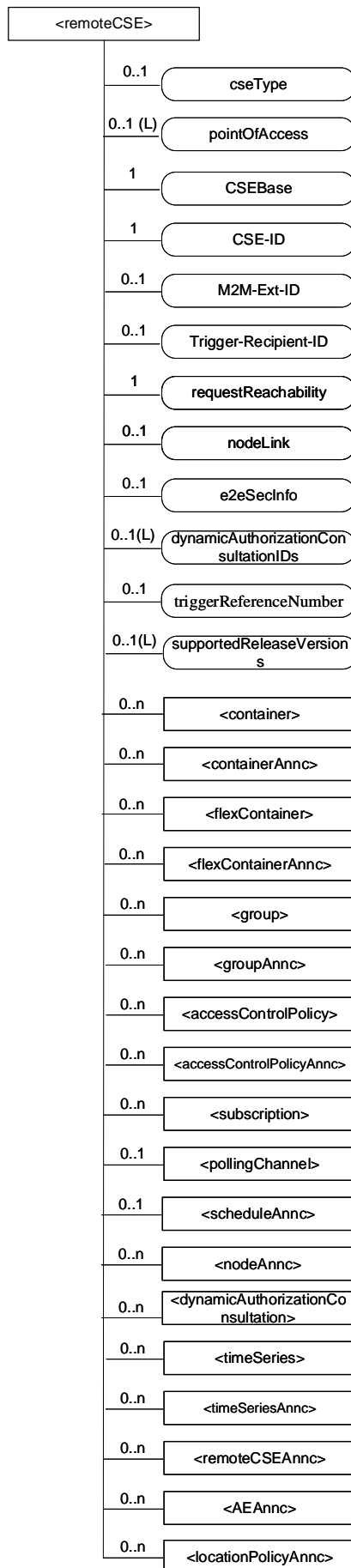

Figure 9.6.4-1: Structure of <remoteCSE> resource

The *<remoteCSE>* resource shall contain the child resources specified in table 9.6.4-1. The *<remoteCSE>* resource may contain *<remoteCSEAnnc>* child resources.

Table 9.6.4-1: Child resources of *<remoteCSE>* resource

Child Resources of <i><remoteCSE></i>	Child Resource Type	Multiplicity	Description	<i><remoteCSEAnnc></i> Child Resource Types
[variable]	<i><container></i>	0..n	See clause 9.6.6	<i><container></i>
[variable]	<i><containerAnnc></i>	0..n	Announced variant of <i><container></i> . See clause 9.6.6	<i><containerAnnc></i>
[variable]	<i><flexContainer></i>	0..n	See clause 9.6.35	<i><flexContainer></i>
[variable]	<i><flexContainerAnnc></i>	0..n	Announced variant of <i><flexContainer></i> . See clause 9.6.35	<i><flexContainerAnnc></i>
[variable]	<i><group></i>	0..n	See clause 9.6.13	<i><group></i>
[variable]	<i><groupAnnc></i>	0..n	Announced variant of <i><group></i> . See clause 9.6.13	<i><groupAnnc></i>
[variable]	<i><accessControlPolicy></i>	0..n	See clause 9.6.2	<i><accessControlPolicy></i>
[variable]	<i><accessControlPolicyAnnc></i>	0..n	Announced variant of <i><accessControlPolicy></i> . See clause 9.6.2	<i><accessControlPolicyAnnc></i>
[variable]	<i><subscription></i>	0..n	See clause 9.6.8	<i><subscription></i>
[variable]	<i><pollingChannel></i>	0..1	See clause 9.6.21. If <i>requestReachability</i> is FALSE, the CSE that created this <i><remoteCSE></i> resource should create a <i><pollingChannel></i> resource and perform long polling. The <i><pollingChannel></i> shall be utilized by the parent resource	None
[variable]	<i><scheduleAnnc></i>	0..1	Announced variant of <i><schedule></i> which defines the reachability schedule information of the node. See clause 9.6.9 for <i><schedule></i>	<i><scheduleAnnc></i>
[variable]	<i><nodeAnnc></i>	0..n	Announced variant of <i><node></i> . This announced resource is associated with a <i><node></i> resource that is hosted on a CSE which is represented by the parent <i><remoteCSE></i> or <i><remoteCSEAnnc></i> resource. See clause 9.6.18 for <i><node></i>	<i><nodeAnnc></i>
[variable]	<i><dynamicAuthorizationConsultation></i>	0..n	See clause 9.6.40	
[variable]	<i><timeSeries></i>	0..n	See clause 9.6.36	<i><timeSeries></i>
[variable]	<i><timeSeriesAnnc></i>	0..n	Announced variant of <i><timeSeries></i> . See clause 9.6.36	<i><timeSeriesAnnc></i>
[variable]	<i><remoteCSEAnnc></i>	0..n	Announced variant of <i><remoteCSE></i> defined in the present clause 9.6.4	<i><remoteCSEAnnc></i>
[variable]	<i><AEAnnc></i>	0..n	Announced variant of <i><AE></i> . See clause 9.6.5	<i><AEAnnc></i>
[variable]	<i><locationPolicyAnnc></i>	0..n	Announced variant of <i><locationPolicy></i> . See clause 9.6.10	<i><locationPolicyAnnc></i>

The *<remoteCSE>* resource shall contain the attributes specified in table 9.6.4-2.

Table 9.6.4-2: Attributes of *<remoteCSE>* resource

Attributes of <i><remoteCSE></i>	Multiplicity	RW/RO/WO	Description	<i><remoteCSEAnnc></i> Attributes
<i>resourceType</i>	1	RO	See clause 9.6.1.3.	NA
<i>resourceID</i>	1	RO	See clause 9.6.1.3.	NA
<i>resourceName</i>	1	WO	See clause 9.6.1.3.	NA
<i>parentID</i>	1	RO	See clause 9.6.1.3.	NA
<i>creationTime</i>	1	RO	See clause 9.6.1.3.	NA
<i>lastModifiedTime</i>	1	RO	See clause 9.6.1.3.	NA
<i>expirationTime</i>	1	RW	See clause 9.6.1.3.	MA

Attributes of <remoteCSE>	Multiplicity	RW/RO/WO	Description	<remoteCSEAnnc> Attributes
accessControlPolicyIDs	0..1 (L)	RW	See clause 9.6.1.3.	MA
labels	0..1 (L)	RW	See clause 9.6.1.3.	MA
announceTo	0..1 (L)	RW	See clause 9.6.1.3.	NA
announcedAttribute	0..1 (L)	RW	See clause 9.6.1.3.	NA
dynamicAuthorizationConsultationIDs	0..1 (L)	RW	See clause 9.6.1.3.	OA
cseType	0..1	WO	Indicates the type of CSE represented by the created resource. <ul style="list-style-type: none"> Mandatory for an IN-CSE, hence multiplicity (1). Its presence is subject to SP configuration in case of an ASN-CSE or a MN-CSE. 	OA
pointOfAccess	0..1 (L)	RW	For request-reachable remote CSE it represents the list of physical addresses to be used to connect to it (e.g. IP address, FQDN). If this information is not provided and <pollingChannel> resource does exist, the CSE should use <pollingChannel> resource. Then the Hosting CSE can forward a request to the CSE without using the PoA.	OA
CSEBase	1	WO	The address of the <CSEBase> resource represented by this <remoteCSE> resource.	OA
CSE-ID	1	WO	The CSE identifier of the remote CSE represented by this <remoteCSE> resource in SP-relative CSE-ID format (clause 7.2).	OA
M2M-Ext-ID	0..1	RW	Supported when Registrar is IN-CSE. See clause 7.1.8 where this attribute is described. This attribute is used only for the case of dynamic association of M2M-Ext-ID and CSE-ID.	NA
Trigger-Recipient-ID	0..1	RW	Supported when Registrar is IN-CSE. See clause 7.1.10 where this attribute is described. This attribute is used only for the case of dynamic association of M2M-Ext-ID and CSE-ID.	NA
requestReachability	1	RW	If the CSE that created this <remoteCSE> resource can receive a request from other AE/CSE(s), this attribute is set to "TRUE" otherwise "FALSE" (see note)	OA
nodeLink	0..1	RW	The resource identifier of a <node> resource that stores the node specific information of the node on which the CSE represented by this <remoteCSE> resource resides.	OA
e2eSecInfo	0..1	RW	See clause 9.6.1.3.	MA
triggerReferenceNumber	0..1	RW	This is to identify device trigger procedure request. This attribute is used only for device trigger and assigned by the IN-CSE.	NA
supportedReleaseVersions	0..1 (L)	RO	List of oneM2M release versions which are supported by the CSE. Starting with Release 2, this attribute is mandatory for a CSE. For CSEs compliant to older releases, this attribute is optional. For CSEs that do not include this attribute, the default release version shall be Release 1.	MA

Attributes of <remoteCSE>	Multiplicity	RW/RO/WO	Description	<remoteCSEAnnc> Attributes
NOTE: Even if this attribute is set to "FALSE", it does not mean it AE/CSE is always unreachable by all entities. E.g. the requesting AE/CSE is behind the same NAT, so it can communicate within the same NAT.				

9.6.5 Resource Type AE

An <AE> resource shall represent information about an Application Entity registered to a CSE.

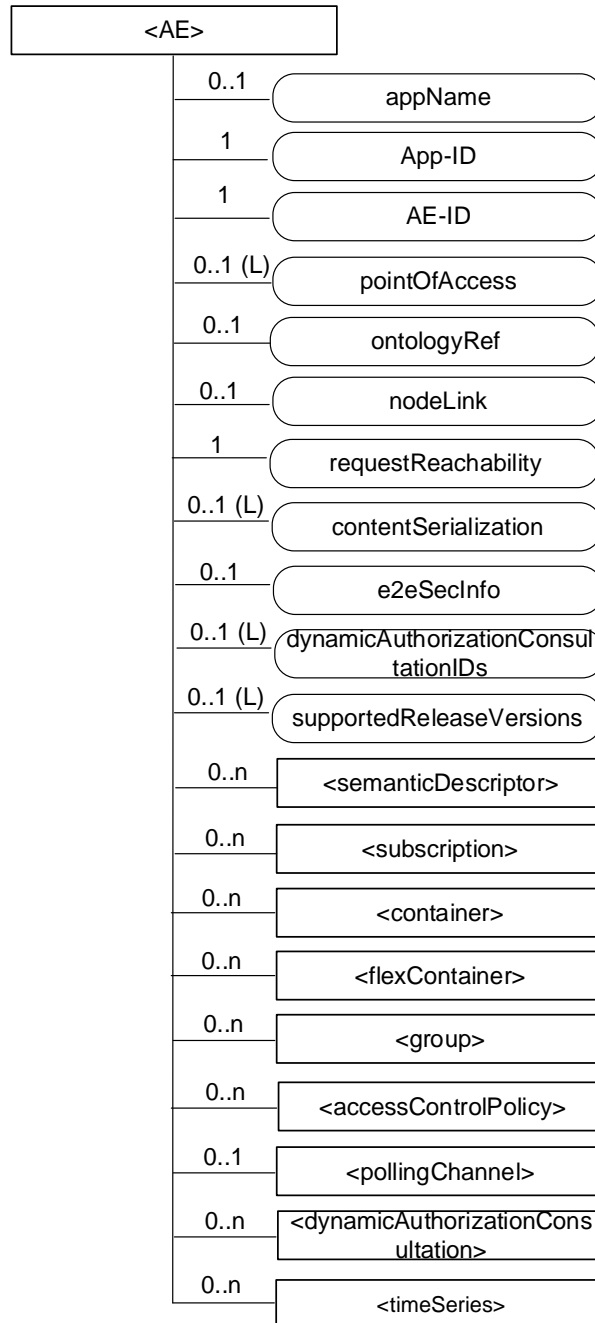

Figure 9.6.5-1: Structure of <AE> resource

The <AE> resource shall contain the child resources specified in table 9.6.5-1.

Table 9.6.5-1: Child resources of <AE> resource

Child Resources of <AE>	Child Resource Type	Multiplicity	Description	<AEAnn> Child Resource Types
[variable]	<semanticDescriptor>	0..n	See clause 9.6.30	<semanticDescriptor>, <semanticDescriptorAnn>
[variable]	<subscription>	0..n	See clause 9.6.8	<subscription>
[variable]	<container>	0..n	See clause 9.6.6	<container>, <containerAnn>
[variable]	<flexContainer>	0..n	See clause 9.6.35	<flexContainer>, <flexContainerAnn>
[variable]	<group>	0..n	See clause 9.6.13	<group>, <groupAnn>
[variable]	<accessControlPolicy>	0..n	See clause 9.6.2	<accessControlPolicy>, <accessControlPolicyAnn>
[variable]	<schedule>	0..1	See clause 9.6.9	<scheduleAnn>
[variable]	<pollingChannel>	0..1	See clause 9.6.21 When the AE is request-unreachable, the AE should create this <pollingChannel> resource and perform long polling. The <pollingChannel> shall be utilized by the parent resource	None
trafficPattern	<trafficPattern>	0..n	See clause 9.6.41	<trafficPatternAnn>
[variable]	<dynamicAuthorizationConsultation>	0..n	See clause 9.6.40	None
[variable]	<timeSeries>	0..n	See clause 9.6.36	<timeSeries>, <timeSeriesAnn>

The <AE> resource shall contain the attributes specified in table 9.6.5-2.

Table 9.6.5-2: Attributes of <AE> resource

Attributes of <AE>	Multiplicity	RW/RO/WO	Description	<AEAnnc> Attributes
<i>resourceType</i>	1	RO	See clause 9.6.1.3.	NA
<i>resourceID</i>	1	RO	See clause 9.6.1.3. Contains the AE-ID-Stem of the AE (see clause 7.2 on identifier formats and clause 10.1.1.2.2 for AE registration procedure).	NA
<i>resourceName</i>	1	WO	See clause 9.6.1.3.	NA
<i>parentID</i>	1	RO	See clause 9.6.1.3.	NA
<i>expirationTime</i>	1	RW	See clause 9.6.1.3.	MA
<i>accessControlPolicyIDs</i>	0..1 (L)	RW	See clause 9.6.1.3.	MA
<i>creationTime</i>	1	RO	See clause 9.6.1.3.	NA
<i>lastModifiedTime</i>	1	RO	See clause 9.6.1.3.	NA
<i>labels</i>	0..1 (L)	RW	See clause 9.6.1.3.	MA
<i>announceTo</i>	0..1 (L)	RW	See clause 9.6.1.3.	NA
<i>announcedAttribute</i>	0..1 (L)	RW	See clause 9.6.1.3.	NA
<i>dynamicAuthorizationConsultationIDs</i>	0..1 (L)	RW	See clause 9.6.1.3.	OA
<i>appName</i>	0..1	RW	The name of the application, as declared by the application developer(e.g. "HeatingMonitoring"). Several sibling resources may share the <i>appName</i> .	OA
<i>App-ID</i>	1	WO	The identifier of the Application (see clause 7.1.3).	OA
<i>AE-ID</i>	1	RO	The identifier of the Application Entity (see clause 7.1.2).	OA
<i>pointOfAccess</i>	0..1 (L)	RW	The list of addresses for communicating with the registered Application Entity over Mca reference point via the transport services provided by Underlying Network (e.g. IP address, FQDN, URI). This attribute shall be accessible only by the AE and the Hosting CSE. If this information is not provided and the <pollingChannel> resource does exist, the AE should use <pollingChannel> resource. Then the Hosting CSE can forward a request to the AE without using the PoA.	OA
<i>ontologyRef</i>	0..1	RW	A URI of the ontology used to represent the information that is managed and understood by the AE.	OA
<i>requestReachability</i>	1	RW	If the AE that created this <AE> resource can receive a request, this attribute is set to "TRUE" otherwise "FALSE"	OA
<i>nodeLink</i>	0..1	RW	The <i>resource identifier</i> of a <node> resource that stores the node specific information of the node on which the AE represented by this <AE> resource resides.	OA
<i>contentSerialization</i>	0..1 (L)	RW	The list of supported serializations of the Content primitive parameter for receiving a request from its registrar CSE. (e.g. XML, JSON). The list shall be ordered so that the most preferred format comes first.	OA

Attributes of <AE>	Multiplicity	RW/RO/WO	Description	<AEAnnc> Attributes
<i>e2eSecInfo</i>	0..1	RW	See clause 9.6.1.3.	MA
<i>supportedReleaseVersions</i>	0..1(L)	WO	The oneM2M release versions supported by the Registree AE represented by this <AE> resource. Starting with Release 2, this attribute is mandatory for an AE. For AEs compliant to older releases, this attribute is optional. For AEs that do not include this attribute, the default release version shall be Release 1.	MA

9.6.6 Resource Type *container*

The *<container>* resource represents a container for data instances. It is used to share information with other entities and potentially to track the data. A *<container>* resource has no associated content. It has only attributes and child resources.

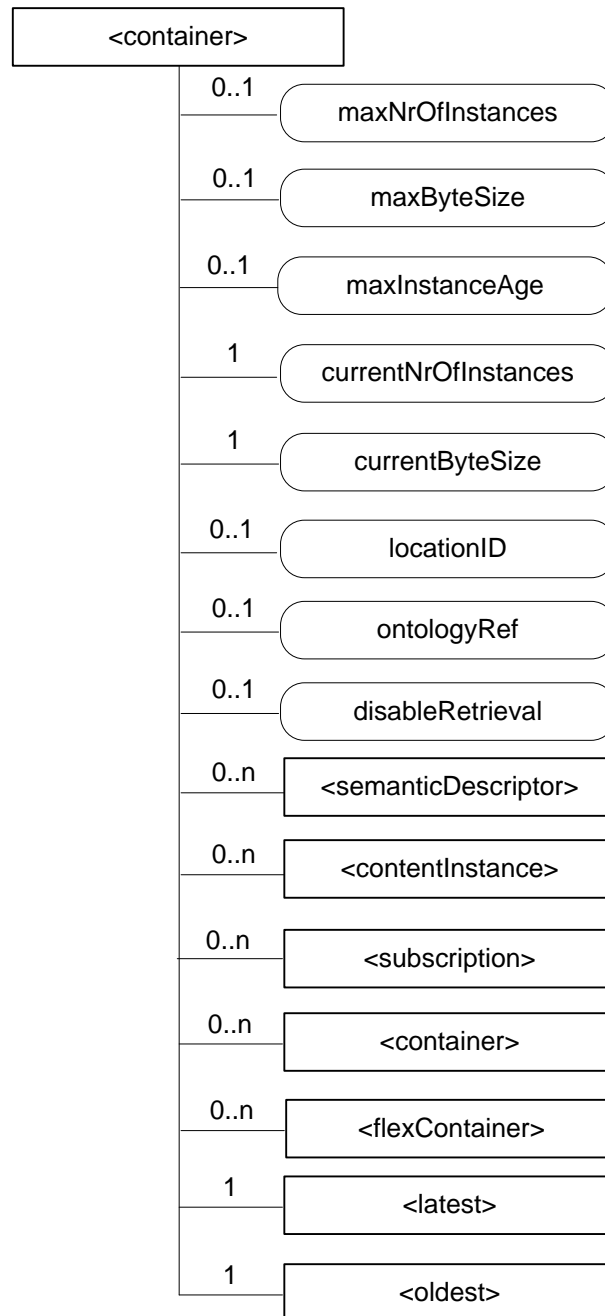

Figure 9.6.6-1: Structure of *<container>* resource

The <container> resource shall contain the child resources specified in table 9.6.6-1.

Table 9.6.6-1: Child resources of <container> resource

Child Resources of <container>	Child Resource Type	Multiplicity	Description	<containerAnnc> Child Resource Types
[variable]	<semanticDescriptor>	0..n	See clause 9.6.30	<semanticDescriptor>, <semanticDescriptorAnnc>
[variable]	<contentInstance>	0..n	See clause 9.6.7	<contentInstance>, <contentInstanceAnnc>
[variable]	<subscription>	0..n	See clause 9.6.8	<subscription>
[variable]	<container>	0..n	See clause 9.6.6	<container>, <containerAnnc>
[variable]	<flexContainer>	0..n	See clause 9.6.35	<flexContainer>, <flexContainerAnnc>
la	<latest>	1	See clause 9.6.27	None
ol	<oldest>	1	See clause 9.6.28	None

The <container> resource shall contain the attributes specified in table 9.6.6-2.

Table 9.6.6-2: Attribute of <container> resource

Attributes of <container>	Multiplicity	RW/RO/WO	Description	<containerAnnc> Attributes
resourceType	1	RO	See clause 9.6.1.3.	NA
resourceID	1	RO	See clause 9.6.1.3.	NA
resourceName	1	WO	See clause 9.6.1.3.	NA
parentID	1	RO	See clause 9.6.1.3.	NA
expirationTime	1	RW	See clause 9.6.1.3.	MA
accessControlPolicyIDs	0..1 (L)	RW	See clause 9.6.1.3. If no accessControlPolicyIDs value is configured, the accessControlPolicyIDs of the parent resource shall be applied for privilege checking.	MA
labels	0..1 (L)	RW	See clause 9.6.1.3.	MA
creationTime	1	RO	See clause 9.6.1.3.	NA
lastModifiedTime	1	RO	See clause 9.6.1.3.	NA
stateTag	1	RO	See clause 9.6.1.3.	OA
announceTo	0..1 (L)	RW	See clause 9.6.1.3.	NA
announcedAttribute	0..1 (L)	RW	See clause 9.6.1.3.	NA
dynamicAuthorizationConsultationIDs	0..1 (L)	RW	See clause 9.6.1.3.	OA
creator	0..1	RO	See clause 9.6.1.3.	NA
maxNrOfInstances	0..1	RW	Maximum number of direct child <contentInstance> resources in the <container> resource.	OA
maxByteSize	0..1	RW	Maximum size in bytes of data (i.e. content attribute of a <contentInstance> resource) that is allocated for the <container> resource for all direct child <contentInstance> resources in the <container> resource.	OA
maxInstanceAge	0..1	RW	Maximum age of a direct child <contentInstance> resource in the <container> resource. The value is expressed in seconds.	OA

Attributes of <container>	Multiplicity	RW/RO/WO	Description	<containerAnnc> Attributes
<i>currentNrOfInstances</i>	1	RO	Current number of direct child <contentInstance> resource in the <container> resource. It is limited by the <i>maxNrOfInstances</i> . The <i>currentNrOfInstances</i> attribute of the <container> resource shall be updated on successful creation or deletion of direct child <contentInstance> resource of <container> resource.	OA
<i>currentByteSize</i>	1	RO	Current size in bytes of data(i.e. <i>content</i> attribute of a <contentInstance> resource) stored in all direct child <contentInstance> resources of a <container> resource. This is the summation of <i>contentSize</i> attribute values of the <contentInstance> resources. It is limited by the <i>maxByteSize</i> . The <i>currentByteSize</i> attribute of the <container> resource shall be updated on successful creation or deletion of direct child <contentInstance> resource of <container> resource.	OA
<i>locationID</i>	0..1	RW	An ID of the resource where the attributes/policies that define how location information are obtained and managed. This attribute is defined only when the <container> resource is used for containing location information.	OA
<i>ontologyRef</i>	0..1	RW	A reference (URI) of the ontology used to represent the information that is stored in the child <contentInstance> resources of the present <container> resource (see note).	OA
<i>disableRetrieval</i>	0..1	RW	Boolean value to control RETRIE/UPDATE/DELETE operation on the child <contentInstance> resource. When the value is set to 'TRUE', RETRIEVE/DELETE/UPDATE operations for child <contentInstance> shall be rejected at all times. When the value is updated from 'TRUE' to 'FALSE', all existing <contentInstance> are deleted immediately. When the value is set to 'FALSE', all operations are permitted on the <contentInstance> resource as per existing procedures.	OA
NOTE: The access to this URI is out of scope of oneM2M.				

9.6.7 Resource Type *contentInstance*

The *<contentInstance>* resource represents a data instance in the *<container>* resource. The content of the *contentInstance* can be encrypted.

Unlike other resources, the *<contentInstance>* resource shall not be modified once created. An AE shall be able to delete a *contentInstance* resource explicitly or it may be deleted by the platform based on policies. If the platform has policies for *contentInstance* retention, these shall be represented by the attributes *maxByteSize*, *maxNrOfInstances* and/or *maxInstanceAge* attributes in the *<container>* resource. If multiple policies are in effect, the strictest policy shall apply.

The *<contentInstance>* resource inherits the same access control policies of the parent *<container>* resource, and does not have its own *accessControlPolicyIDs* attribute.

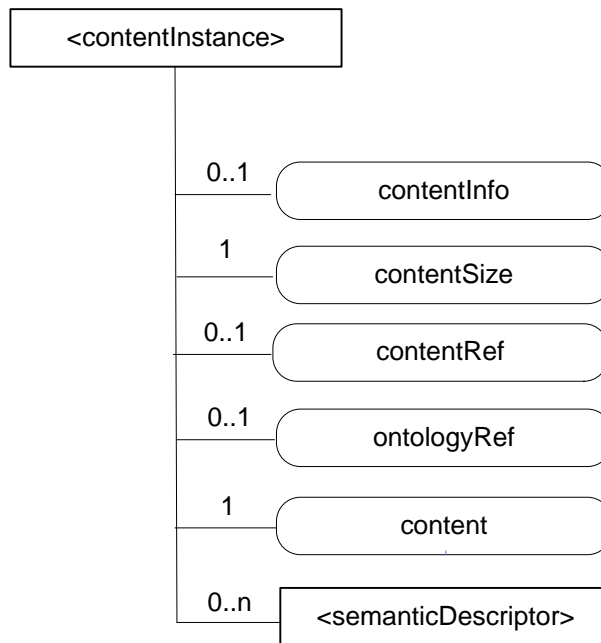

Figure 9.6.7-1: Structure of *<contentInstance>* resource

The *<contentInstance>* resource shall contain the child resources specified in table 9.6.7-1.

Table 9.6.7-1: Child resources of *<container>* resource

Child Resources of <i><contentInstance></i>	Child Resource Type	Multiplicity	Description	<i><contentInstanceAnnc></i> Child Resource Types
[variable]	<i><semanticDescriptor></i>	0..n	See clause 9.6.30	<i><semanticDescriptor></i> , <i><semanticDescriptorAnnc></i>

The <contentInstance> resource shall contain the attributes specified in table 9.6.7-2.

Table 9.6.7-2: Attributes of <contentInstance> resource

Attributes of <contentInstance>	Multiplicity	RW/RO/WO	Description	<contentInstanceAnn> Attributes
<i>resourceType</i>	1	RO	See clause 9.6.1.3.	NA
<i>resourceID</i>	1	RO	See clause 9.6.1.3.	NA
<i>resourceName</i>	1	WO	See clause 9.6.1.3.	NA
<i>parentID</i>	1	RO	See clause 9.6.1.3.	NA
<i>labels</i>	0..1 (L)	WO	See clause 9.6.1.3.	MA
<i>expirationTime</i>	1	WO	See clause 9.6.1.3.	NA
<i>creationTime</i>	1	RO	See clause 9.6.1.3.	NA
<i>lastModifiedTime</i>	1	RO	See clause 9.6.1.3.	NA
<i>stateTag</i>	1	RO	See clause 9.6.1.3. The <i>stateTag</i> attribute of the parent resource should be incremented first and copied into this <i>stateTag</i> attribute when a new instance is added to the parent resource.	OA
<i>announceTo</i>	0..1 (L)	WO	See clause 9.6.1.3.	NA
<i>announcedAttribute</i>	0..1 (L)	WO	See clause 9.6.1.3.	NA
<i>creator</i>	0..1	RO	See clause 9.6.1.3.	NA
<i>contentInfo</i>	0..1	WO	This attribute contains information to understand the contents of <i>content</i> attribute. It shall be composed of two mandatory components consisting of Internet Media Type (as defined in the IETF RFC 6838) and an encoding type. In addition, an optional content security component may also be included. The format of this attribute is defined in oneM2M TS-0004 [3]. This attribute should be used so that AEs can understand the content.	OA
<i>contentSize</i>	1	RO	Size in bytes of the <i>content</i> attribute.	OA
<i>contentRef</i>	0..1	WO	This attribute contains a list of name-value pairs. Each entry expresses and associative reference to a <contentInstance> resource. The name of the entry indicates the relationship and the value of the entry the indicates reference (URI) to the resource.	OA
<i>ontologyRef</i>	0..1	WO	A reference (URI) of the ontology used to represent the information that is stored in the <i>contentInstances</i> resources of the <container> resource. If this attribute is not present, the <i>contentInstance</i> resource inherits the <i>ontologyRef</i> from the parent <container> resource if present (see note).	OA
<i>content</i>	1	WO	Actual content of a <i>contentInstance</i> . This content may be opaque data for understandable with the help of the <i>contentInfo</i> . This may, for example, be an image taken by a security camera, or a temperature measurement taken by a temperature sensor.	OA

NOTE: Access to this URI is out of scope of oneM2M.

9.6.8 Resource Type *subscription*

The *<subscription>* resource contains subscription information for its subscribed-to resource.

The *<subscription>* resource shall be represented as child resource of the subscribed-to resource. For example, *<container>* resource has *<subscription>* resource as a child resource (see clause 9.6.6). A *<subscription>* resource shall be deleted when the parent subscribed-to resource is deleted.

The *<subscription>* resource shall represent a subscription to a subscribed-to resource. An Originator shall be able to create a resource of *<subscription>* resource type when the Originator has RETRIEVE privilege to the subscribe-to resource. The Originator which creates a *<subscription>* resource becomes the resource subscriber.

Each *<subscription>* may include notification policies that specify which, when, and how notifications are sent. These notification policies may work in conjunction with CMDH policies.

When a *<subscription>* resource is deleted, a Notify request shall be sent to the *subscriberURI* if it is provided by the Originator.

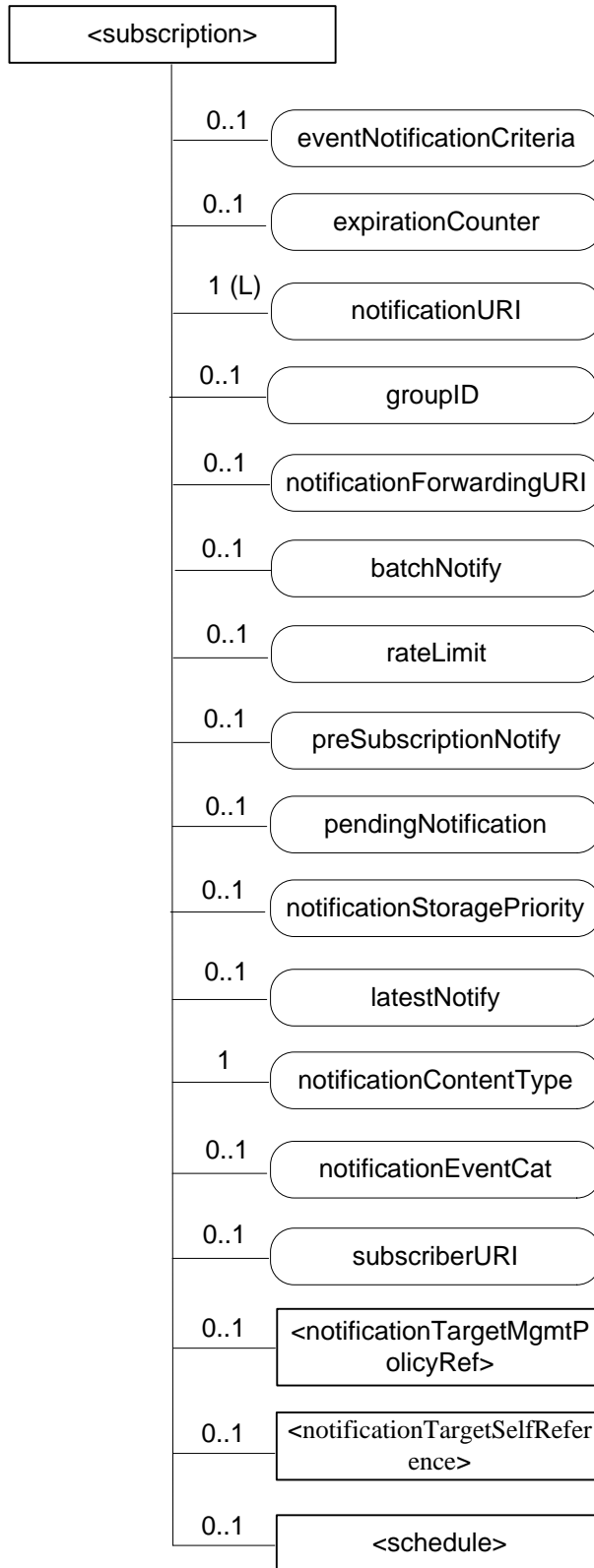

Figure 9.6.8-1: Structure of <subscription> resource

The <subscription> resource shall contain the child resources specified in table 9.6.8-1.

Table 9.6.8-1: Child resources of <subscription> resource

Child Resources of <subscription>	Child Resource Type	Multiplicity	Description
notificationSchedule	<schedule>	0..1	In the context of the <subscription> resource, the notificationSchedule specifies when notifications may be sent by the Hosting CSE to the notificationURI(s). See clause 9.6.9.
[variable]	<notificationTarget MgmtPolicyRef>	0..n	See clause 9.6.31 for this type of resource.
ntsr	<notificationTarget SelfReference>	1	See clause 9.6.34 for this type of resource.

The <subscription> resource shall contain the attributes specified in table 9.6.8-2.

Table 9.6.8-2: Attributes of <subscription> resource

Attributes of <subscription>	Multiplicity	RW/RO/WO	Description
resourceType	1	RO	See clause 9.6.1.3.
resourceID	1	RO	See clause 9.6.1.3.
resourceName	1	WO	See clause 9.6.1.3.
parentID	1	RO	See clause 9.6.1.3.
expirationTime	1	RW	See clause 9.6.1.3.
creationTime	1	RO	See clause 9.6.1.3.
lastModifiedTime	1	RO	See clause 9.6.1.3.
labels	0..1 (L)	RW	See clause 9.6.1.3.
accessControlPolicyIDs	0..1 (L)	RW	See clause 9.6.1.3. If no accessControlPolicyIDs value is configured, the accessControlPolicyIDs of the parent resource shall be applied for privilege checking.
dynamicAuthorizationConsultationIDs	0..1 (L)	RW	See clause 9.6.1.3.
creator	0..1	WO	See clause 9.6.1.3.
eventNotificationCriteria	0..1	RW	This attribute (notification policy) indicates the event criteria for which a notification is to be generated.
expirationCounter	0..1	RW	This attribute (notification policy) indicates that the subscriber wants to set the life of this subscription to a limit of a maximum number of notifications. When the number of notifications sent reaches the count of this counter, the <subscription> resource shall be deleted, regardless of any other policy.

Attributes of <subscription>	Multiplicity	RW/RO/WO	Description
<i>notificationURI</i>	1 (L)	RW	<p>This attribute shall be configured as a list consisting of one or more targets that the Hosting CSE shall send notifications to. A target shall be formatted as a oneM2M compliant Resource-ID as defined in clause 7.2 or as an identifier compliant with a oneM2M supported protocol binding (e.g. http, coap, mqtt).</p> <p>If a target is formatted as a oneM2M compliant Resource-ID, then the target shall be formatted as a structured or unstructured CSE-Relative-Resource-ID, SP-Relative-Resource-ID, and/or Absolute-Resource-ID. A Hosting CSE shall use this information to determine proper pointOfAccess, requestReqchability and/or pollingChannel information needed to send a notification to the target. The following is an example:</p> <ul style="list-style-type: none"> • /CSE0001/AE0001 <p>For a target that is formatted as an identifier compliant with a oneM2M supported protocol binding, the details of this format are defined by the respective oneM2M protocol specification. The following is an example of an HTTP URI compliant with oneM2M HTTP protocol binding:</p> <ul style="list-style-type: none"> • https://172.25.30.25:7000/notification/handler <p>For a subscription to a <fanOutPoint> Resource, if subscription resource in request contains a <i>notificationForwardingURI</i>, then the Group Hosting CSE shall configure the <i>notificationURI</i> of the fanout subscription request with an address specified by the Group Hosting CSE that can be used by the Group Hosting CSE to receive aggregated notifications.</p>
<i>groupID</i>	0..1	RW	<p>The ID of a <group> resource in case the subscription is made through a group. This attribute may be used in the Filter Criteria to discover all subscription resources created via a <fanOutPoint> resource to a specific groupID.</p>
<i>notificationForwardingURI</i>	0..1	RW	<p>The attribute is a forwarding attribute that shall be present only for group related subscriptions. It represents the resource subscriber notification target. It shall be used by group Hosting CSE for forwarding aggregated notifications. See clauses 10.2.7.11 and 10.2.7.12.</p> <p>This attribute shall be configured with the target of the subscriber if the subscriber intends for the Group Hosting CSE to aggregate the notifications. The target is used by the Group Hosting CSE to determine where to send aggregated notifications. A target shall be formatted as a oneM2M compliant Resource-ID as defined in clause 7.2 or as an identifier compliant with one of the oneM2M supported protocol bindings (the detailed format of which are defined by each respective oneM2M protocol binding specification).</p>
<i>batchNotify</i>	0..1	RW	<p>This attribute (notification policy) indicates that the subscription originator wants to receive batches of notifications rather than receiving them one at a time. This attribute includes : the number of notifications to be batched for delivery and the duration. When only the number is specified by the subscription originator, the Hosting CSE shall set the default duration given by M2M Service Provider. If <i>batchNotify</i> is used simultaneously with <i>latestNotify</i>, only the latest notification shall be sent and have the Event Category set to "latest".</p>

Attributes of <subscription>	Multiplicity	RW/RO/WO	Description
<i>rateLimit</i>	0..1	RW	This attribute (notification policy) indicates that the subscriber wants to limit the rate at which it receives notifications. This attribute expresses the subscriber's notification policy and includes two values: a maximum number of events that may be sent within some duration, and the <i>rateLimit</i> window duration. When the number of generated notifications within the <i>rateLimit</i> window duration exceeds the maximum number, notification events are temporarily stored, until the end of the window duration, when the sending of notification events restarts in the next window duration. The sending of notification events continues as long as the maximum number of notification events is not exceeded during the window duration. The <i>rateLimit</i> policy may be used simultaneously with other notification policies.
<i>preSubscriptionNotify</i>	0..1	WO	This attribute (notification policy) indicates that the subscriber wants to be sent notifications for events that were generated prior to the creation of this subscription. This attribute has a value of the number of prior notification events requested. If up-to-date caching of retained events is supported on the Hosting CSE and contains the subscribed events then prior notification events will be sent up to the number requested. The <i>preSubscriptionNotify</i> policy may be used simultaneously with any other notification policy.
<i>pendingNotification</i>	0..1	RW	This attribute (notification policy), if set, indicates how missed notifications due to a period of no connectivity are handled (according to the reachability and notification schedules). The possible values for <i>pendingNotification</i> are: <ul style="list-style-type: none"> • "sendLatest"; • "sendAllPending". This policy depends upon caching of retained notifications on the hosted CSE. When this attribute is set to "sendLatest", only the last notification shall be sent and it shall have the Event Category set to "latest". If this attribute is not present, the Hosting CSE sends no missed notifications. This policy applies to all notifications regardless of the selected delivery policy (<i>batchNotify</i> , <i>latestNotify</i> , etc.) Note that unreachability due to reasons other than scheduling is not covered by this policy.

Attributes of <subscription>	Multiplicity	RW/ RO/ WO	Description
<i>notificationStoragePriority</i>	0..1	RW	Indicates that the subscriber wants to set a priority for this subscription relative to other subscriptions belonging to this same subscriber. This attribute sets a number within the priority range. When storage of notifications exceeds the allocated size, this policy is used as an input with the storage congestion policy (<i>notificationCongestionPolicy</i>) specified in clause 9.6.3 to determine which stored and generated notifications to drop and which ones to retain.
<i>latestNotify</i>	0..1	RW	This attribute (notification policy) indicates if the subscriber wants only the latest notification. If multiple notifications of this subscription are buffered, and if the value of this attribute is set to true, then only the last notification shall be sent and it shall have the Event Category value set to "latest".
<i>notificationContentType</i>	1	RW	Indicates a notification content type that shall be contained in notifications. The allowed values are: <ul style="list-style-type: none"> • "modified attributes"; • "all attributes"; • "ID" of the resource indicated in the <i>notificationEventType</i> condition. If it is not given by the Originator at the creation procedure, default is "all attributes".
<i>notificationEventCat</i>	0..1	RW	This attribute (notification policy) indicates the subscriber's requested Event Category to be used for notification messages generated by this subscription.
<i>subscriberURI</i>	0..1	WO	This attribute shall be configured with the target of the subscriber. The target is used by the Hosting CSE to determine where to send a notification when the subscription is deleted. A target shall be formatted as a oneM2M compliant Resource-ID as defined in clause 7.2 or as an identifier compliant with one of the oneM2M supported protocol bindings (the detailed format of which are defined by each respective oneM2M protocol binding specification).

Table 9.6.8-3 describes the *eventNotificationCriteria* conditions.

Table 9.6.8-3: *eventNotificationCriteria* conditions

Condition tag	Multiplicity	Matching condition
<i>createdBefore</i>	0..1	The <i>creationTime</i> attribute of the resource is chronologically before the specified value.
<i>createdAfter</i>	0..1	The <i>creationTime</i> attribute of the resource is chronologically after the specified value.
<i>modifiedSince</i>	0..1	The <i>lastModifiedTime</i> attribute of the resource is chronologically after the specified value.
<i>unmodifiedSince</i>	0..1	The <i>lastModifiedTime</i> attribute of the resource is chronologically before the specified value.
<i>stateTagSmaller</i>	0..1	The <i>stateTag</i> attribute of the resource is smaller than the specified value.
<i>stateTagBigger</i>	0..1	The <i>stateTag</i> attribute of the resource is bigger than the specified value.
<i>expireBefore</i>	0..1	The <i>expirationTime</i> attribute of the resource is chronologically before the specified value.
<i>expireAfter</i>	0..1	The <i>expirationTime</i> attribute of the resource is chronologically after the specified value.
<i>sizeAbove</i>	0..1	The <i>contentSize</i> attribute of the < <i>contentInstance</i> > resource is equal to or greater than the specified value.
<i>sizeBelow</i>	0..1	The <i>contentSize</i> attribute of the < <i>contentInstance</i> > resource is smaller than the specified value.
<i>notificationEventType</i>	0..5	<p>The type of event. Possible notification event type values are:</p> <ul style="list-style-type: none"> a) Update to attributes of the subscribed-to resource. b) Deletion of the subscribed-to resource. c) Creation of a direct child of the subscribed-to resource. d) Deletion of a direct child of the subscribed-to resource. e) An attempt to retrieve a <<i>contentInstance</i>> direct-child-resource of a subscribed-to <container> resource is performed while this <<i>contentInstance</i>> child resource is an obsolete resource or the reference used for retrieving this resource is not assigned. This retrieval is performed by a RETRIEVE request targeting the subscribed-to resource with the <i>Result Content</i> parameter set to either "child-resources" or "attributes+child-resources". <p>The other conditions in <i>eventNotificationCriteria conditions</i> apply to the selected <i>notificationEventType</i>. For example, if <i>notificationEventType</i> is "Creation of a direct child of the subscribed-to resource" then other <i>eventNotificationCriteria</i> conditions is applied to the direct child resources of the subscribed-to resource. If this condition is not specified, the default value is "Update to attributes of the subscribed-to resource". The notion of "obsolete resource" is defined in clause 9.6.1.3.2 (Common attributes).</p>
<i>operationMonitor</i>	0..5	The operations accessing the subscribed-to resource matches with the specified value. It allows monitoring which operation is attempted to the subscribed-to resource regardless of whether the operation is performed. This feature is useful when to find malicious AEs. Possible string arguments are: create, retrieve, update, delete.

Condition tag	Multiplicity	Matching condition
<i>attribute</i>	0..n	<p>A list of attribute names of a subscribed-to-resource. This list is only applicable when <i>notificationEventType</i> has a value of "Update to attributes of the subscribed-to resource".</p> <p>If this list is present, then it is used to specify a subset of a subscribed-to-resource's attributes for which updates shall result in a notification. If ANY attribute specified on this list is updated, then a notification shall be generated. If an attribute that is not specified in this list is updated, then a notification shall not be generated.</p> <p>If this list is not presented, then the default attribute list is the full set of a subscribed-to-resource's attributes. If ANY attribute of a subscribed-to-resource is updated, then a notification shall be generated.</p>
<i>missingData</i>	0..1	<p>The <i>missingData</i> includes two values: a minimum specified missing number of the Time Series Data within the specified window duration, and the window duration. The condition only applies to subscribed-to resources of type <i><timeSeries></i>. The first detected missing data point starts the timer associated with the window duration.</p> <p>The window duration is restarted upon its expiry until such time as the entire subscription is terminated or not refreshed. More details about NOTIFICATIONS related to data reporting is found in clause 10.2.39.</p>
<i>filterOperation</i>	0..1	Indicates the logical operation (AND/OR) to be used for different condition tags. The default value is logical AND.

The rules when multiple conditions are used together shall be as follows:

- Different condition tags shall use the "AND/OR" logical operation based on the *filterOperation* specified.
- Same condition tags shall use the "OR" logical operation.

No mixed AND/OR filter operation will be supported.

9.6.9 Resource Type *schedule*

The *<schedule>* resource contains scheduling information. The usage of the *<schedule>* resource is slightly different depending on the associated resource type, such as follows:

- A child *<schedule>* resource of the *<CSEBase>* resource shall indicate the time periods when the CSE can send and receive the request.
- A child *<schedule>* resource of the *<AE>* resource shall indicate the time periods when the application entity can be accessed.

NOTE 1: The ASN/MN-CSE needs to assure the consistency between the information in the child *<schedule>* resource of *<AE>* and child *<schedule>* resource of *<CSEBase>*.

NOTE 2: The mechanisms to assure consistency between *<schedule>* resources are FFS.

- A child *<schedule>* resource of the *<subscription>* resource shall indicate the time periods when the notifications can be sent to be Receiver.
- A *<schedule>* resource linked as *mgmtLink* attribute of the *<cmdhNwAccessRule>* resource shall indicate the time periods when use of specific underlying networks is allowed.
- A child *<schedule>* resource of the *<trafficPattern>* resource shall indicate the time periods when the traffic pattern of a node applies to the underlying network that is indicated by the *targetNetwork* attribute of the *<trafficPattern>* resource.

An Originator shall have the same access control privileges to the *<schedule>* resource as it has to its parent resource.

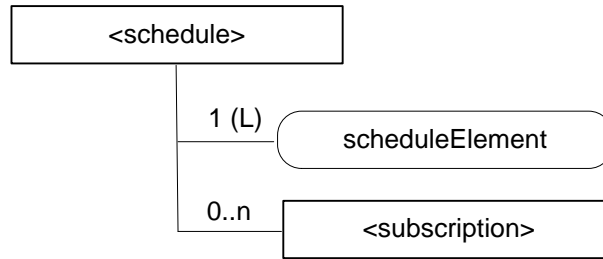

Figure 9.6.9-1: Structure of <schedule> resource

The <schedule> resource shall contain the child resource specified in table 9.6.9-1.

Table 9.6.9-1: Child resources of <schedule> resource

Child Resources of <schedule>	Child Resource Type	Multiplicity	Description	<scheduleAnnc> Child Resource Types
[variable]	<subscription>	0..n	See clause 9.6.8	None

The <schedule> resource shall contain the attributes specified in table 9.6.9-2.

Table 9.6.9-2: Attributes of <schedule> resource

Attributes of <schedule>	Multiplicity	RW/RO/WO	Description	<scheduleAnnc> Attributes
resourceType	1	RO	See clause 9.6.1.3.	NA
resourceID	1	RO	See clause 9.6.1.3.	NA
resourceName	1	WO	See clause 9.6.1.3.	NA
parentID	1	RO	See clause 9.6.1.3.	NA
expirationTime	1	RW	See clause 9.6.1.3.	MA
creationTime	1	RO	See clause 9.6.1.3.	NA
lastModifiedTime	1	RO	See clause 9.6.1.3.	NA
labels	0..1 (L)	RW	See clause 9.6.1.3.	MA
announceTo	0..1 (L)	RW	See clause 9.6.1.3.	NA
announcedAttribute	0..1 (L)	RW	See clause 9.6.1.3.	NA
scheduleElement	1 (L)	RW	A scheduleElement shall be composed by seven fields of second, minute, hour, day of month, month, day of week and year.	OA

9.6.10 Resource Type *locationPolicy*

The <locationPolicy> resource represents the method for obtaining and managing geographical location information of an M2M Node.

The actual location or event result (in case Geo-fence-Based method) information shall be stored in a <contentInstance> resource which is a child resource of the <container> resource. The <container> resource includes the locationID attribute which holds the ID of this <locationPolicy> resource. A CSE can obtain location information based on the attributes defined under <locationPolicy> resource, and store the location information in the target <container> resource.

Based on the locationSource attribute, the method for obtaining location information of an M2M Node can be differentiated. The methods for obtaining location information shall be as follows:

- **Network-based method:** where the CSE on behalf of the AE obtains the target M2M Node's location information from an Underlying Network.
- **Device-based method:** where the ASN is equipped with any location capable modules or technologies (e.g. GPS) and is able to position itself.

- **Sharing-based method:** where the ADN has no GPS nor an Underlying Network connectivity. Its location information can be retrieved from either the associated ASN or a MN.

NOTE: Geographical location information could include more than longitude and latitude.

Figure 9.6.10-0 shows the graphical information regarding the event types for the Geo-fence feature defined as the *geofenceEventCriteria* attribute. The time difference between t_1 and t_2 described in the figure below is defined by *locationUpdatePeriod* attribute.

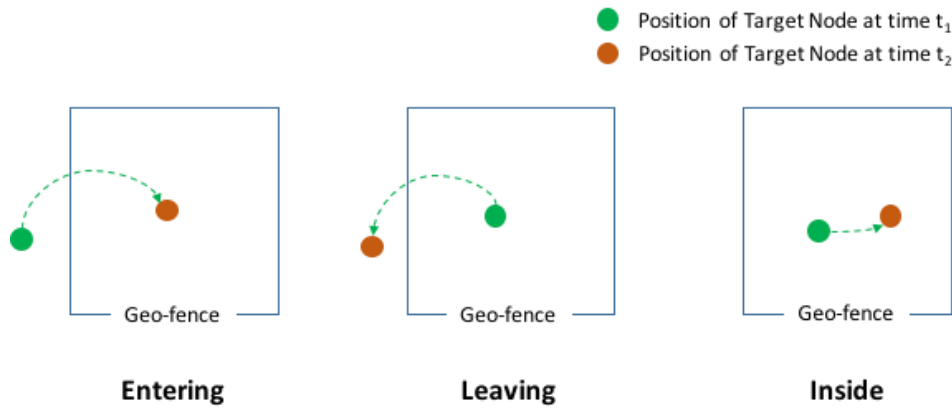

Figure 9.6.10-0: The Event Types for the Geo-fence

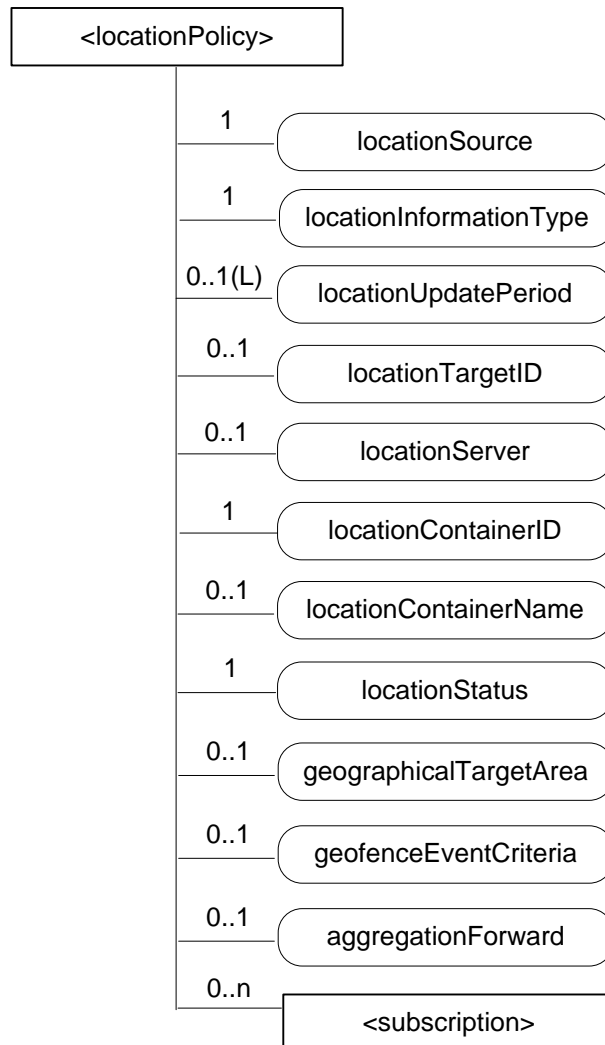

Figure 9.6.10-1: Structure of <locationPolicy> resource

The <locationPolicy> resource shall contain the child resources specified in table 9.6.10-1.

Table 9.6.10-1: Child resources of <locationPolicy> resource

Child Resources of <locationPolicy>	Child Resource Type	Multiplicity	Description	<locationPolicyAnnc> Child Resource Types
[variable]	<subscription>	0..n	See clause 9.6.8	None

The <locationPolicy> resource shall contain the attributes specified in table 9.6.10-2.

Table 9.6.10-2: Attributes of <locationPolicy> resource

Attributes of <locationPolicy>	Multiplicity	RW/RO/WO	Description	<locationPolicyAnnc> Attributes
resourceType	1	RO	See clause 9.6.1.3.	NA
resourceID	1	RO	See clause 9.6.1.3.	NA
resourceName	1	WO	See clause 9.6.1.3.	NA
parentID	1	RO	See clause 9.6.1.3.	NA
expirationTime	1	RW	See clause 9.6.1.3.	MA
accessControlPolicyIDs	0..1 (L)	RW	See clause 9.6.1.3.	MA
creationTime	1	RO	See clause 9.6.1.3.	NA
lastModifiedTime	1	RO	See clause 9.6.1.3.	NA
labels	0..1 (L)	RW	See clause 9.6.1.3.	MA
announceTo	0..1 (L)	RW	See clause 9.6.1.3.	NA
announcedAttribute	0..1 (L)	RW	See clause 9.6.1.3.	NA
dynamicAuthorizationConsultationIDs	0..1 (L)	RW	See clause 9.6.1.3.	OA
locationSource	1	RW	Indicates the source of location information: <ul style="list-style-type: none"> • Network Based; • Device Based; • Sharing Based. 	OA
locationInformationType	1	RW	Indicate the types of location information: <ul style="list-style-type: none"> • Position fix (e.g. longitude and latitude); • Geo-fence event (e.g. entering and leaving). 	OA
locationUpdatePeriod	0..1(L)	RW	Indicates the period for updating location information. If the value is marked '0' or not defined, location information is updated only when a retrieval request to the <latest> child resource of the <container> indicated by locationContainerID is detected . If the attribute has more than one value and the hosting CSE of the resource is the target device, the value could be selected within the listed values depending on device's local context information (e.g. velocity, status of battery, range of the location etc.). Zero('0') shall not be stored with non-zero value(s). When the value is read, the first value in the list is the current active update period.	OA

Attributes of <locationPolicy>	Multiplicity	RW/RO/WO	Description	<locationPolicyAnnc> Attributes
locationTargetID	0..1	RW	The identifier to be used for retrieving the location information of a remote Node and this attribute is only used in the case that location information is provided by a location server. For example, when the remote Node is a 3GPP UE, locationTargetID could be M2M-Ext-ID or MSISDN.	OA
locationServer	0..1	RW	Indicates the identity of the location or Geo-fence server. This attribute is only used in that case location information is provided by a location server or Geo-fence server.	OA
locationContainerID	1	RO	ID of the <container> resource where the actual location information or event result of a M2M Node is stored.	OA
locationContainerName	0..1	WO	A name of the <container> resource where the actual location information of a M2M Node is stored. If it is not assigned, the Hosting CSE automatically assigns a name of the resource (see note).	OA
locationStatus	1	RO	Contains the information on the current status of the location request (e.g. location server fault).	OA
geographicalTargetArea	0..1	RW	Indicates area information where the Geo-fence feature is applied.	OA
geofenceEventCriteria	0..1	RW	Indicate the event type of Geo-fence feature: <ul style="list-style-type: none"> • Entering; • Leaving; • Inside; • Outside. 	OA
aggregationForward	0..1	RW	Indicate how Geo-fence relevant information (e.g. measurement or position fix) from the target node is forwarded to Geo-fence server: <ul style="list-style-type: none"> • True/False; • Number of Events; • Time-based Accumulation. 	OA
NOTE: The created <container> resource related to this policy shall be stored only in the Hosting CSE.				

9.6.11 Resource Type *delivery*

When a CSE is requested to initiate an operation (CRUDN) targeting resources on another CSE, then it needs to do scheduling and execution of delivery of data from the source CSE to the target CSE in line with the provisioned policies. It shall be in one of the following ways:

- using delivery aggregation (**Delivery Aggregation** information set to ON); or
- forwarding the original request as a separate request on the Mcc reference point without changes.

In order to be able to initiate and manage the execution of data delivery in a resource-based manner, resource type *<delivery>* is defined. This resource type shall be used for forwarding requests from one CSE to another CSE when the **Delivery Aggregation** parameter in the request is set to ON. If the **Delivery Aggregation** parameter is set to OFF, the original request shall be forwarded without change to the next CSE, i.e. without the use of *<delivery>* resource. If the **Delivery Aggregation** parameter is not present, the latter method shall be used.

Operations to Retrieve, Update or Delete a *<delivery>* resource shall allow authorized entities to inquire the status of a delivery, change delivery attributes or cancel a delivery.

As defined in clause 10.2.4, *<delivery>* resource can only be created by a CSE. A request for the creation of a *<delivery>* resource can only be issued to a registrar or registree CSE from a registree or registrar CSE with a direct registration relationship among each other (i.e. no transit CSE). *<delivery>* resource is deleted on successful delivery of the data in the *aggregatedRequest* attribute to the next hop CSE.

The parent of a *<delivery>* resource is the *<CSEBase>* resource of the CSE that accepted the request for the creation of the *<delivery>* resource.

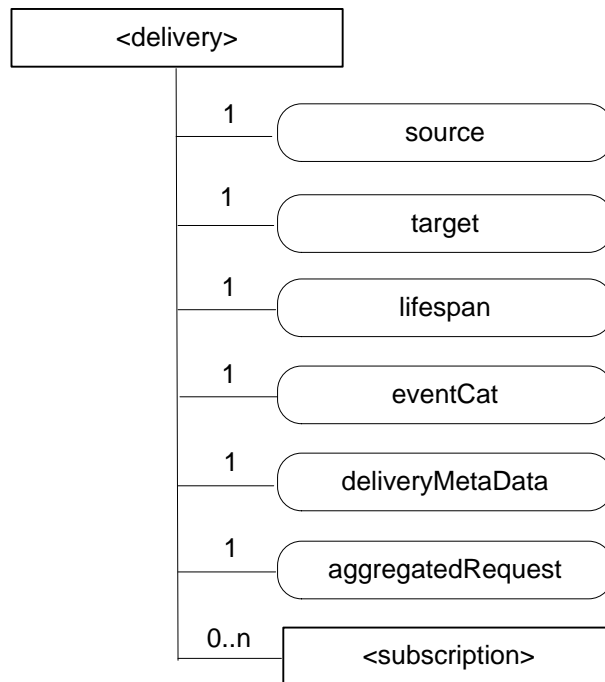

Figure 9.6.11-1: Structure of *<delivery>* resource

The *<delivery>* resource shall contain the child resource specified in table 9.6.11-1.

Table 9.6.11-1: Child resources of *<delivery>* resource

Child Resources of <i><delivery></i>	Child Resource Type	Multiplicity	Description
[variable]	<i><subscription></i>	0..n	See clause 9.6.8

The <delivery> resource shall contain the attributes specified in table 9.6.11-2.

Table 9.6.11-2: Attributes of <delivery> resource

Attributes of <delivery>	Multiplicity	RW/RO/WO	Description
resourceType	1	RO	See clause 9.6.1.3.
resourceID	1	RO	See clause 9.6.1.3.
resourceName	1	WO	See clause 9.6.1.3.
expirationTime	1	RW	See clause 9.6.1.3.
parentID	1	RO	See clause 9.6.1.3.
creationTime	1	RO	See clause 9.6.1.3.
lastModifiedTime	1	RO	See clause 9.6.1.3.
accessControlPolicyIDs	0..1 (L)	RW	See clause 9.6.1.3.
labels	0..1 (L)	RW	See clause 9.6.1.3.
stateTag	1	RO	See clause 9.6.1.3.
dynamicAuthorizationConsultationIDs	0..1 (L)	RW	See clause 9.6.1.3.
source	1	WO	The CSE-ID of the CSE that initiated the delivery process represented by this <delivery> resource.
target	1	WO	CSE-ID that defines the Hosting CSE for delivering the data contained in the <i>aggregatedRequest</i> attribute.
lifespan	1	RW	Defines the time limit when the delivery of the information in the <i>aggregatedRequest</i> attribute needs to complete. If the <i>lifespan</i> expires before successful delivery, no further attempts to deliver the information in the <i>aggregatedRequest</i> attribute need to be executed. If the delivery fails, a feedback may be expected by the source CSE depending on options reflected in the <i>deliveryMetaData</i> attribute. The <i>lifespan</i> attribute of a <delivery> resource shall be set consistent with the Request Expiration Timestamp parameters of the set of original requests contained in the <i>aggregatedRequest</i> attribute, i.e. <i>lifespan</i> shall not extend beyond the earliest expiring Request Expiration Timestamp parameter in the set of the original requests contained in the <i>aggregatedRequest</i> attribute.
eventCat	1	RW	Defines the category of the event that triggered the delivery request represented by this <delivery> resource.
deliveryMetaData	1	RW	Contains meta information on the delivery process represented by this <delivery> resource, such as delivery status, delivery options, tracing information, etc.
aggregatedRequest	1	WO	Attribute containing the request(s) to be delivered to the Hosting CSE. This represents one or more original requests that were targeting the same Hosting CSE.

9.6.12 Resource Type *request*

Creation of a <request> resource shall only be done on a Receiver CSE implicitly when a Registree AE or a Registree/Registrar CSE issues a request to the Receiver CSE targeting any other resource type or requesting a notification in non-blocking mode. Creation of a <request> resource is only permitted by the Receiver CSE after reception of a valid Request which contains the **Response Type** parameter that is set to '*nonBlockingRequestSynch*' or '*nonBlockingRequestAsynch*'.

When a CSE is requested to initiate an operation for which the result should be available to the Originator by **Request Expiration Timestamp** information of the request set to 'nonBlockingRegeustSynch' or 'nonBlockingRequestAsynch', the Receiver CSE which received the request directly from the Originator shall provide a reference of the created <request> resource back to the Originator so that the Originator can access attributes of the <request> resource at a later time - for instance in order to retrieve the result of an operation that was taking a longer time. If the Receiver CSE supports <request> resource type, the reference that shall be given back to the Originator as part of the acknowledgment that is the address of the <request> resource. The Originator (or any other authorized entity depending on access control) can access the request status and the requested operation result through it.

The <request> resource may be deleted by the CSE that is hosting it when the expiration time of the <request> resource is reached. So after the expiration time of a <request> resource is reached it cannot be assumed that particular <request> resource is still accessible. A <request> resource may also get deleted earlier than the expiration time, when the result of the requested operation (if any result was requested at all) has been sent back to the Originator.

For the purpose of providing a standardized structure for expressing and accessing the context of a previously issued request, the resource type <request> is defined. The parent resource of a <request> resource shall be the <CSEBase> resource of the Hosting CSE.

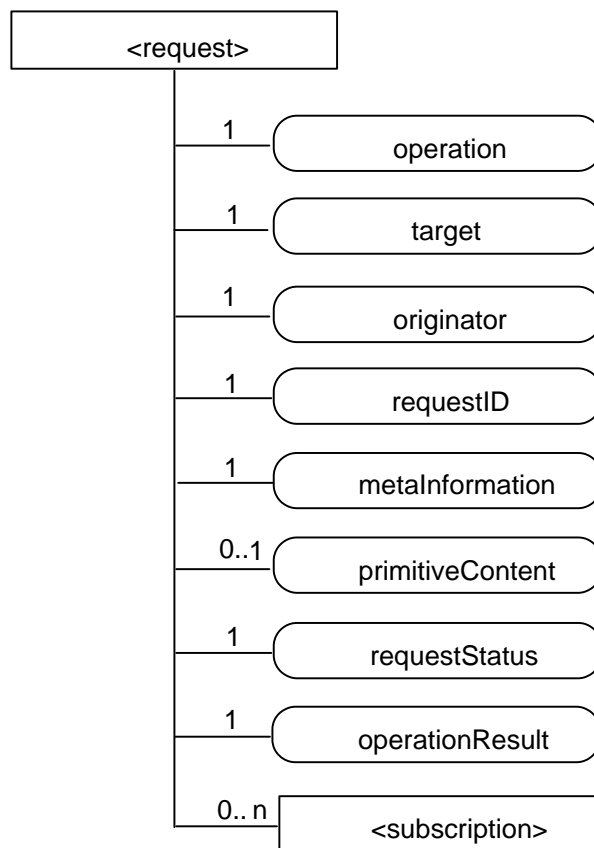

Figure 9.6.12-1: Structure of <request> resource

The <request> resource shall contain the child resources specified in table 9.6.12-1.

Table 9.6.12-1: Child resources of <request> resource

Child Resources of <request>	Child Resource Type	Multiplicity	Description
[variable]	<subscription>	0..n	See clause 9.6.8

The <request> resource shall contain the attributes specified in table 9.6.12-2.

Table 9.6.12-2: Attributes of <request> resource

Attributes of <request>	Multiplicity	RW/RO/WO	Description
resourceType	1	RO	See clause 9.6.1.3.
resourceID	1	RO	See clause 9.6.1.3.
resourceName	1	WO	See clause 9.6.1.3.
expirationTime	1	RW	See clause 9.6.1.3. The value of the <i>expirationTime</i> is chosen by the CSE dependent on the Request Expiration Timestamp , Result Expiration Timestamp , Result Persistence and Operation Execution Time parameters associated with the original request.
parentID	1	RO	See clause 9.6.1.3.
creationTime	1	RO	See clause 9.6.1.3.
lastModifiedTime	1	RO	See clause 9.6.1.3.
accessControlPolicyIDs	0..1 (L)	RO	See clause 9.6.1.3.
labels	0..1 (L)	RO	See clause 9.6.1.3.
stateTag	1	RO	See clause 9.6.1.3.
dynamicAuthorizationConsultationIDs	0..1 (L)	RO	See clause 9.6.1.3.
operation	1	RO	It contains the value of the parameter Operation in the original request message.
target	1	RO	It contains the value of the parameter To in the original request message.
originator	1	RO	It contains the value of the parameter From in the original request message.
requestID	1	RO	It contains the value of the parameter Request Identifier in the original request message.
metaInformation	1	RO	Meta information about the request. The content of this attribute is equivalent to information in any other optional parameters described in clause 8.1.
primitiveContent	0..1	RO	Contains the content that is carried in the Content parameter of the original request message.
requestStatus	1	RO	Contains information on the current status of the Request, e.g. "accepted and pending".
operationResult	1	RO	Contains the result of the originally requested operation in line with the Result Content parameter associated with the original request.

All operations on <request> resources except for the CREATE operations - which shall only be triggered implicitly - are controlled by the access control policy.

9.6.13 Resource Type *group*

The *<group>* resource represents a group of resources of the same or mixed types. The *<group>* resource can be used to do bulk manipulations on the resources represented by the *memberIDs* attribute. The *<group>* resource contains an attribute that represents the members of the group and the *<fanOutPoint>* virtual resource that enables generic operations to be applied to all the resources represented by those members. By grouping *<semanticDescriptor>* resources across which a semantic description is distributed, another virtual resource (*<semanticFanOutPoint>*) enables semantic discovery procedures to be applied across the full logical tree in the description.

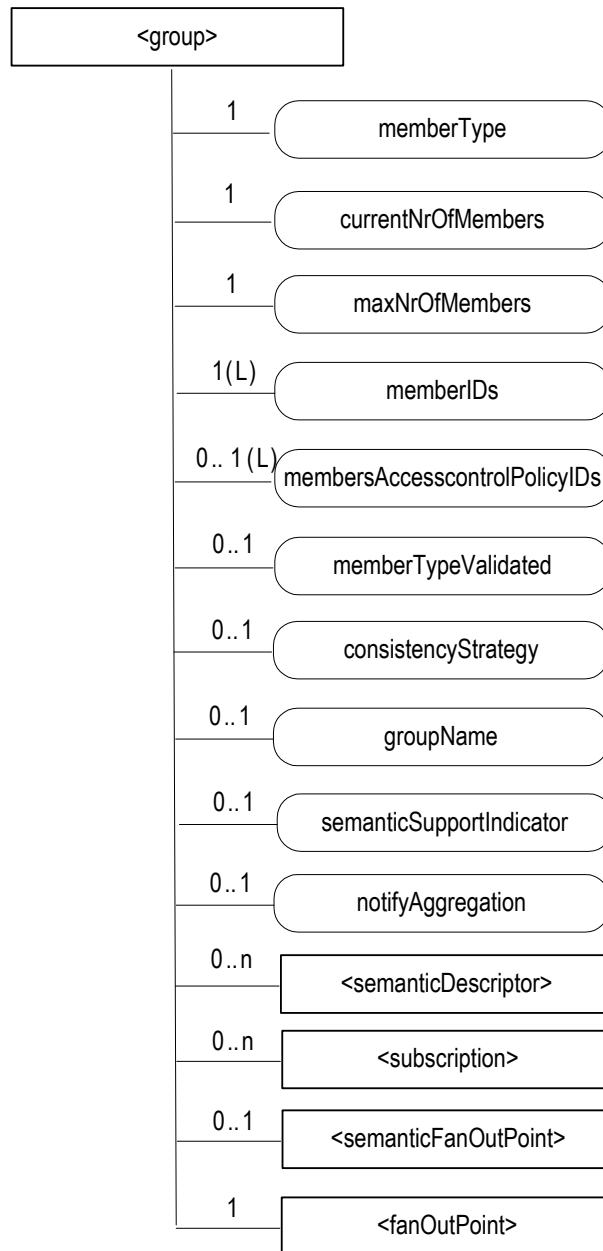

Figure 9.6.13-1: Structure of *<group>* resource

The *<group>* resource shall contain the child resources specified in table 9.6.13-1.

Table 9.6.13-1: Child resources of *<group>* resource

Child Resources of <i><group></i>	Child Resource Type	Multiplicity	Description	<i><groupAnnnc></i> Child Resource Types
[variable]	<i><semanticDescriptor></i>	0..n	See clause 9.6.30	<i><semanticDescriptor></i> , <i><semanticDescriptorAnnnc></i>
[variable]	<i><subscription></i>	0..n	See clause 9.6.8	<i><subscription></i>
<i>fopt</i>	<i><fanOutPoint></i>	1	See clause 9.6.14	none
<i>sfopt</i>	<i><semanticFanOutPoint></i>	0..1	See clause 9.6.14a	none

The *<group>* resource shall contain the attributes specified in table 9.6.13-2.

Table 9.6.13-2: Attributes of *<group>* resource

Attributes of <i><group></i>	Multiplicity	RW/RO/WO	Description	<i><groupAnnnc></i> Attributes
<i>resourceType</i>	1	RO	See clause 9.6.1.3.	NA
<i>resourceID</i>	1	RO	See clause 9.6.1.3.	NA
<i>resourceName</i>	1	WO	See clause 9.6.1.3.	NA
<i>parentID</i>	1	RO	See clause 9.6.1.3.	NA
<i>expirationTime</i>	1	RW	See clause 9.6.1.3.	MA
<i>accessControlPolicyIDs</i>	0..1 (L)	RW	See clause 9.6.1.3.	MA
<i>labels</i>	0..1 (L)	RW	See clause 9.6.1.3.	MA
<i>creationTime</i>	1	RO	See clause 9.6.1.3.	NA
<i>lastModifiedTime</i>	1	RO	See clause 9.6.1.3.	NA
<i>announceTo</i>	0..1 (L)	RW	See clause 9.6.1.3.	NA
<i>announcedAttribute</i>	0..1 (L)	RW	See clause 9.6.1.3.	NA
<i>dynamicAuthorizationConsultationIDs</i>	0..1 (L)	RW	See clause 9.6.1.3.	OA
<i>creator</i>	0..1	RO	See clause 9.6.1.3.	NA
<i>memberType</i>	1	WO	It is the resource type of the member resources of the group, if all member resources (including the member resources in any sub-groups) are of the same type. Otherwise, it is of type 'mixed'.	OA
<i>currentNrOfMembers</i>	1	RO	Current number of members in a group. It shall not be larger than <i>maxNrOfMembers</i> .	OA
<i>maxNrOfMembers</i>	1	RW	Maximum number of members in the <i><group></i> .	OA
<i>memberIDs</i>	1 (L)	RW	List of member resource IDs referred to in the remaining of the present document as <i>memberID</i> . Each ID (<i>memberID</i>) should refer to a member resource or a (sub-) <i><group></i> resource of the <i><group></i> if <i>memberID</i> is suffixed with " <i>fopt</i> ". A <i><group></i> resource with an empty member list is allowed.	OA
<i>membersAccessControlPolicyIDs</i>	0..1 (L)	RW	List of IDs of the <i><accessControlPolicy></i> resources defining who is allowed to access the <i><fanOutPoint></i> resource.	OA
<i>memberTypeValidated</i>	0..1	RO	Denotes if the resource types of all members resources of the group has been validated by the Hosting CSE. In the case that the <i>memberType</i> attribute of the <i><group></i> resource is not 'mixed', then this attribute shall be set..	OA

Attributes of <group>	Multiplicity	RW/RO/WO	Description	<groupAnnc> Attributes
<i>consistencyStrategy</i>	1	WO	This attribute determines how to deal with the <group> resource if the <i>memberType</i> validation fails. Its possible values are: <ul style="list-style-type: none"> ABANDON_MEMBER. ABANDON_GROUP. SET_MIXED. Which means delete the inconsistent member if the attribute is ABANDON_MEMBER; delete the group if the attribute is ABANDON_GROUP; set the <i>memberType</i> to "mixed" if the attribute is SET_MIXED. If it is not given by the Originator at the creation procedure, default is "ABANDON_MEMBER".	OA
<i>groupName</i>	0..1	RW	Human readable name of the <group>.	OA
<i>semanticSupportIndicator</i>	0..1	RO	Indicator of support for semantic discovery functionality via <semanticFanOutPoint>.	OA
<i>notifyAggregation</i>	0..1	RW	This attribute specifies the number of messages and/or the duration that the group hosting CSE will aggregate notification messages when the subscriptions created specify aggregation of notifications i.e. specifying the <i>notificationForwardingURI</i> of the original <subscription> resource.	OA

9.6.14 Resource Type *fanOutPoint*

The <*fanOutPoint*> resource is a virtual resource because it does not have a representation. It is the child resource of a <*group*> resource. Whenever a request is sent to the <*fanOutPoint*> resource, the request is fanned out to each of the members of the <*group*> resource indicated by the *membersIDs* attribute of the <*group*> resource. The responses (to the request) from each member are then aggregated and returned to the Originator. A timer should be set for the aggregation. The responses are aggregated if all the responses expected have been received or when the timer expires. The responses received after the time expires should be discarded. If the **Result Expiration Timestamp** parameter is received from the Originator, the timer should be set to enforce this parameter, otherwise, the timer is set based on the local policy configured at the Hosting CSE.

The <*fanOutPoint*> resource does not have a resource representation by itself and consequently it does not have an *accessControlPolicyIDs* attribute. The <*accessControlPolicy*> resource used for access control policy validation is indicated by the *membersAccessControlPolicyIDs* attribute in the parent <*group*> resource.

9.6.14a Resource Type *semanticFanOutPoint*

The <*semanticFanOutPoint*> resource is a virtual resource because it does not have a representation. It is the child resource of a <*group*> resource with members of type <*semanticDescriptor*>.

Whenever a semantic discovery request is sent to the <*semanticFanOutPoint*> resource the host uses the *memberIDs* attribute of the parent <*group*> resource to retrieve all the related descriptors. If there are descriptors stored on different CSEs, individual RETRIEVE requests are sent to each CSE for retrieving the external descriptors. All semantic descriptors are accessed based on the respective access control policies.

Once all of the related <*semanticDescriptor*>(s) have been retrieved, the content of each of the descriptor attributes is added to the content on which the SPARQL request is being executed. The full/enlarged content subject to the SPARQL request is provided to the SPARQL engine for processing.

The <*semanticFanOutPoint*> resource uses *membersAccessControlPolicyIDs* attribute in the parent <*group*> resource for access control policy validation.

9.6.15 Resource Type *mgmtObj*

The *<mgmtObj>* resource contains management data which represents individual M2M management functions. It represents a general structure to map to technology specific data model e.g. OMA DM [i.3], BBF TR-069 [i.2] and LWM2M [i.4]. Each instance of *<mgmtObj>* resource shall be mapped to single technology specific protocol.

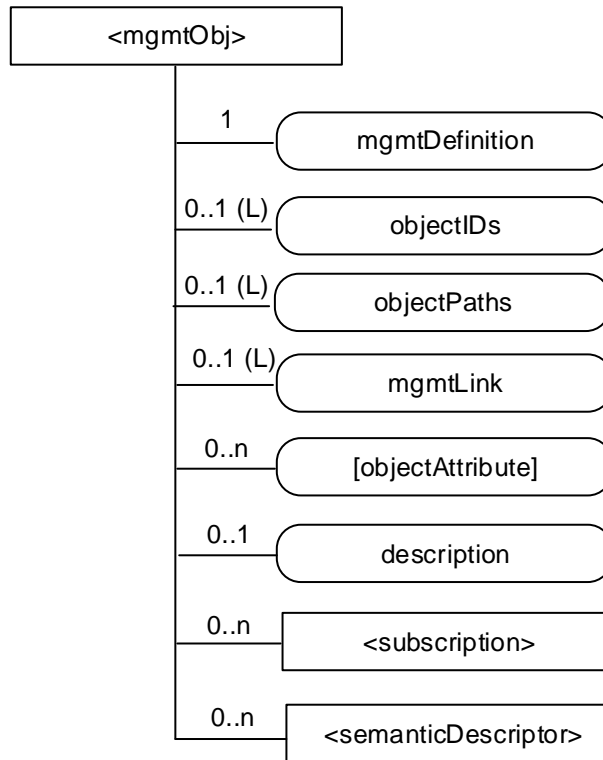

Figure 9.6.15-1: Structure of *<mgmtObj>* resource

The *<mgmtObj>* resource shall contain the child resource specified in table 9.6.15-1.

Table 9.6.15-1: Child resources of *<mgmtObj>* resource

Child Resources of <i><mgmtObj></i>	Child Resource Type	Multiplicity	Description	<i><mgmtObjAnnnc></i> Child Resource Type
[variable]	<i><subscription></i>	0..n	See clause 9.6.8	<i><subscription></i>
[variable]	<i><semanticDescriptor></i>	0..n	See clause 9.6.30	<i><semanticDescriptor></i> , <i><semanticDescriptorAnnnc></i>

The *<mgmtObj>* resource shall contain the attributes specified in table 9.6.15-2.

Table 9.6.15-2: Attributes of *<mgmtObj>* resource

Attributes of <i><mgmtObj></i>	Multiplicity	RW/RO/WO	Description	<i><mgmtObjAnnnc></i> Attributes
<i>resourceType</i>	1	RO	See clause 9.6.1.3.	NA
<i>resourceID</i>	1	RO	See clause 9.6.1.3.	NA
<i>resourceName</i>	1	WO	See clause 9.6.1.3.	NA
<i>parentID</i>	1	RO	See clause 9.6.1.3.	NA
<i>expirationTime</i>	1	RW	See clause 9.6.1.3.	MA
<i>accessControlPolicyIDs</i>	0..1 (L)	RW	See clause 9.6.1.3.	MA
<i>creationTime</i>	1	RO	See clause 9.6.1.3.	NA
<i>lastModifiedTime</i>	1	RO	See clause 9.6.1.3.	NA
<i>labels</i>	0..1 (L)	RW	See clause 9.6.1.3.	MA
<i>announceTo</i>	0..1 (L)	RW	See clause 9.6.1.3.	NA
<i>announcedAttribute</i>	0..1 (L)	RW	See clause 9.6.1.3.	NA

Attributes of <mgmtObj>	Multiplicity	RW/ RO/ WO	Description	<mgmtObjAnnc> Attributes
<i>dynamicAuthorizationConsultationIDs</i>	0..1 (L)	RW	See clause 9.6.1.3.	OA
<i>mgmtDefinition</i>	1	WO	Specifies the type of <mgmtObj> resource e.g. software, firmware, memory. The list of the value of the attribute can be seen in annex D.	MA
<i>objectIDs</i>	0..1 (L)	WO	Contains the list URNs that uniquely identify the technology specific data model objects used for this <mgmtObj> resource as well as the managed function and version it represents. This attribute shall be provided during the creation of the <mgmtObj> resource and shall not be modifiable afterwards. If the <mgmtObj> resource is mapped to multiple technology specific data model objects, this attribute shall list all URNs for each mapped technology specific data model objects. This is mandatory for the <mgmtObj>, for which the data model is not specified by oneM2M but mapped from technology specific data model.	OA
<i>objectPaths</i>	0..1 (L)	WO	Contains the list of local paths of the technology specific data model objects on the managed entity which is represented by the <mgmtObj> resource in the Hosting CSE. This attribute shall be provided during the creation of the <mgmtObj>, so that the Hosting CSE can correlate the created <mgmtObj> with the technology specific data model object on the managed entity for further management operations. It shall not be modifiable after creation. The format of this attribute shall be a local technology specific data model object path in the form as specified by technology specific protocol. (e.g. "/anyPath/Fw1" in OMA DM [i.3], "Device.USBHosts.Host.3." in BBF TR-069 [i.2]). The combination of the <i>objectPaths</i> and the <i>objectIDs</i> attribute, allows to address the technology specific data model.	OA
<i>mgmtLink</i>	0..1 (L)	RW	This attribute contains reference to a list of other <mgmtObj> resources in case a hierarchy of <mgmtObj> is needed.	OA
[<i>objectAttribute</i>]	0..n	RW	Each [<i>objectAttribute</i>] is mapped from a leaf node of a hierarchical structured technology specific data model object (including oneM2M data model and the technology specific data model objects) based on the mapping rules below the table.	OA
<i>description</i>	0..1	RW	Text format description of <mgmtObj>.	OA

When mapping objects from technology specific protocol to a corresponding *<mgmtObj>* resource, the following rules shall apply:

- The root objects of technology specific data model objects maps to the *<mgmtObj>* resource.
- For the child of the root of technology specific data model objects:
 - **Rule1:** If the child technology specific data model object cannot have another child technology specific data model object, the technology specific data model object maps to the *[objectAttribute]* attribute of the *<mgmtObj>* resource with the same resource name.
 - **Rule2:** If the child technology specific data model object can have another child technology specific data model object, the technology specific data model object maps to a new *<mgmtObj>* resource. The ID of the new *<mgmtObj>* resource is stored as an *mgmtLink* attribute of the *<mgmtObj>* resource which is mapped from the parent technology specific data model object.

9.6.16 Resource Type *mgmtCmd*

The *<mgmtCmd>* resource represents a method to execute management procedures or to model commands and remote procedure calls (RPC) required by existing management protocols (e.g. BBF TR-069 [i.2]), and enables AEs to request management procedures to be executed on a remote entity. It also enables cancellation of cancellable and initiated but unfinished management procedures or commands.

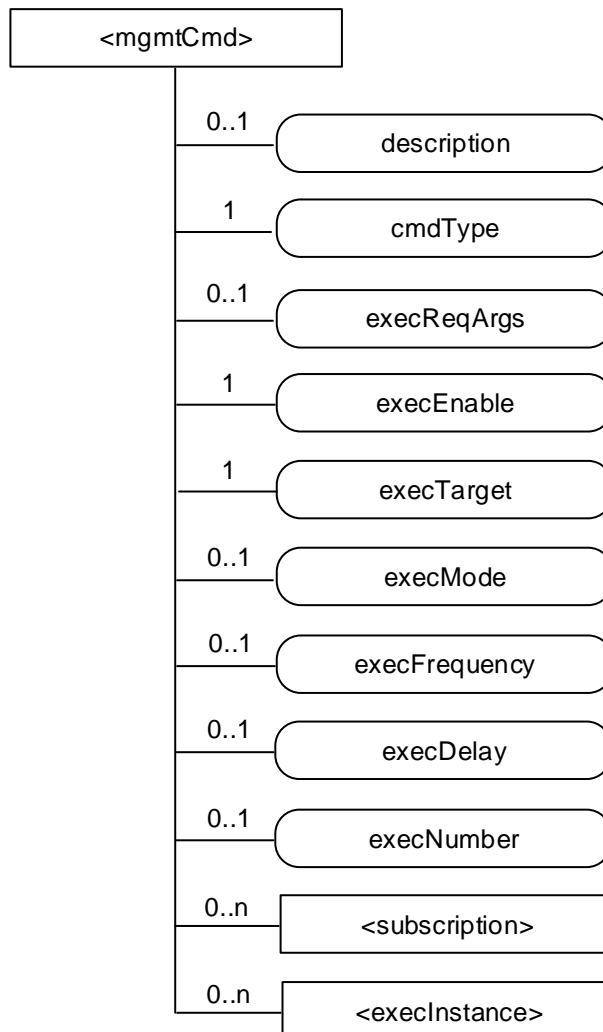

Figure 9.6.16-1: Structure of *<mgmtCmd>* resource

Each *<mgmtCmd>* corresponds to a specific type of management command, as defined by its attribute *cmdType*. For multiple requests of the same management command, *<mgmtCmd>* shall use separate child-resources (i.e. *<execInstance>*) to contain each execution instance. The execution of the management procedure represented by *<mgmtCmd>* shall be triggered using the UPDATE method to its attribute *execEnable*.

The *<mgmtCmd>* resource shall contain the child resources specified in table 9.6.16-1.

Table 9.6.16-1: Child resources of *<mgmtCmd>* resource

Child Resources of <i><mgmtCmd></i>	Child Resource Type	Multiplicity	Description
[variable]	<i><subscription></i>	0..n	See clause 9.6.8
[variable]	<i><execInstance></i>	0..n	See clause 9.6.17

The *<mgmtCmd>* resource shall contain the attributes specified in table 9.6.16-2.

Table 9.6.16-2: Attributes of *<mgmtCmd>* resource

Attributes of <i><mgmtCmd></i>	Multiplicity	RW/RO/WO	Description
<i>resourceType</i>	1	RO	See clause 9.6.1.3
<i>resourceID</i>	1	RO	See clause 9.6.1.3.
<i>resourceName</i>	1	WO	See clause 9.6.1.3.
<i>parentID</i>	1	RO	See clause 9.6.1.3.
<i>expirationTime</i>	1	RW	See clause 9.6.1.3
<i>accessControlPolicyIDs</i>	0..1 (L)	RW	See clause 9.6.1.3
<i>labels</i>	0..1 (L)	RW	See clause 9.6.1.3
<i>creationTime</i>	1	RO	See clause 9.6.1.3
<i>lastModifiedTime</i>	1	RO	See clause 9.6.1.3
<i>dynamicAuthorizationConsultationIDs</i>	0..1 (L)	RW	See clause 9.6.1.3.
<i>description</i>	0..1	RW	The text-format description of this resource.
<i>cmdType</i>	1	WO	The type to identify the management operation (e.g. download).
<i>execReqArgs</i>	0..1	RW	Structured attribute (e.g. abstract type) to contain any command-specific arguments of the request.
<i>execEnable</i>	1	RW	Writing a value to this attribute via the UPDATE method causes execution of the <i><mgmtCmd></i> .
<i>execTarget</i>	1	RW	ID of the <i><node></i> resource of the target on which this <i><mgmtCmd></i> will be executed. It may be the URI of a <i><group></i> resource in which case the <i><mgmtCmd></i> will be executed on all members in the <i>memberIDs</i> attribute of the addressed <i><group></i> resource.
<i>execMode</i>	0..1	RW	The mode used to specify how the command will be executed (e.g. Immediate Once, Immediate and Repeatedly, Random Once, Random and Repeatedly). May be used together with <i>execFrequency</i> , <i>execDelay</i> and <i>execNumber</i> to provide the scheduling information.
<i>execFrequency</i>	0..1	RW	The minimum interval between two executions, to be used in conjunction with <i>execMode</i> . Modes involving random execution can be used to add random values between individual executions.
<i>execDelay</i>	0..1	RW	The minimum delay before the instance should be executed. Modes involving random execution can be used to increase this delay randomly.
<i>execNumber</i>	0..1	RW	The number of times the instance should be executed, to be used when <i>execMode</i> indicates a repetition pattern.

9.6.17 Resource Type *execInstance*

The *<execInstance>* resource represents a successful instance of *<mgmtCmd>* execution request, which had been triggered by a M2M network application using the UPDATE method to the attribute *execEnable* of *<mgmtCmd>* resource.

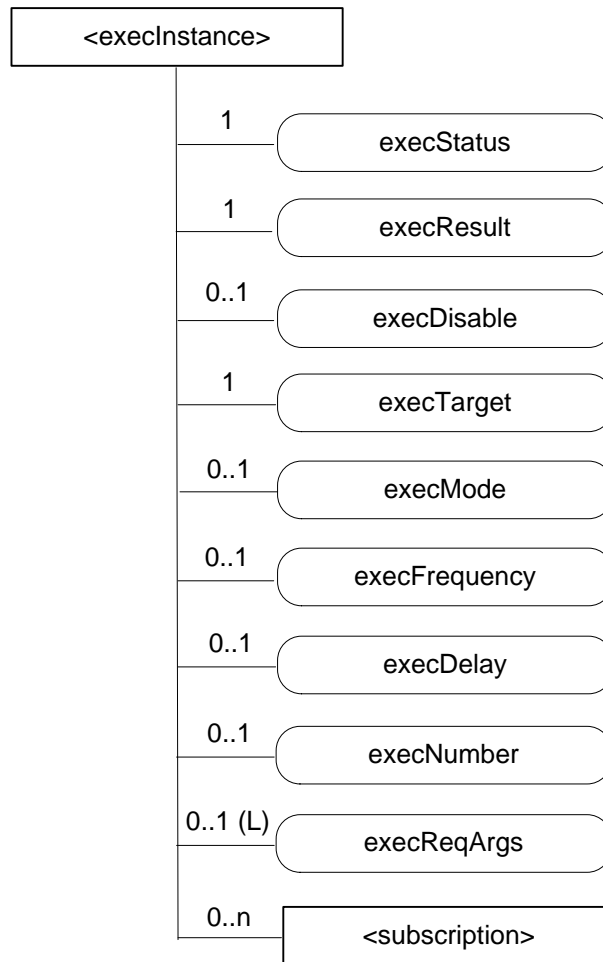

Figure 9.6.17-1: Structure of *<execInstance>* resource

The *<execInstance>* resource shall contain the child resources specified in table 9.6.17-1.

Table 9.6.17-1: Child resources of *<execInstance>* resource

Child Resources of <i><execInstance></i>	Child Resource Type	Multiplicity	Description
[variable]	<i><subscription></i>	0..n	See clause 9.6.8

The *<execInstance>* resource shall contain the attributes specified in table 9.6.17-2.

Table 9.6.17-2: Attributes of *<execInstance>* resource

Attributes of <i><execInstance></i>	Multiplicity	RW/ RO/ WO	Description
<i>resourceType</i>	1	RO	See clause 9.6.1.3.
<i>resourceID</i>	1	RO	See clause 9.6.1.3.
<i>resourceName</i>	1	WO	See clause 9.6.1.3.
<i>expirationTime</i>	1	RO	See clause 9.6.1.3.
<i>parentID</i>	1	RO	See clause 9.6.1.3.
<i>accessControlPolicyIDs</i>	0..1 (L)	RW	See clause 9.6.1.3.
<i>creationTime</i>	1	RO	See clause 9.6.1.3.
<i>lastModifiedTime</i>	1	RO	See clause 9.6.1.3.
<i>labels</i>	0..1 (L)	RW	See clause 9.6.1.3.
<i>dynamicAuthorizationConsultationIDs</i>	0..1 (L)	RW	See clause 9.6.1.3.
<i>execStatus</i>	1	RO	The status of <i><execInstance></i> . It can be Initiated, Started, Finished, Cancelled, or Deleted.
<i>execResult</i>	1	RO	The execution result of <i><execInstance></i> .
<i>execDisable</i>	0..1	RW	The attribute is used to cancel <i><execInstance></i> using UPDATE method.
<i>execTarget</i>	1	RO	ID of <i><node></i> resource of the target on which the <i><execInstance></i> will be executed.
<i>execMode</i>	0..1	RO	Modes used to specify how the command will be executed (e.g. Immediate Once, Immediate and Repeatedly, Random Once, Random and Repeatedly). May be used together with <i>execFrequency</i> , <i>execDelay</i> and <i>execNumber</i> to provide the scheduling information.
<i>execFrequency</i>	0..1	RO	The minimum interval between two executions, to be used in conjunction with <i>execMode</i> . Modes involving random execution can be used to add random values between individual executions.
<i>execDelay</i>	0..1	RO	The minimum delay before the instance should be executed. Modes involving random execution can be used to increase this delay randomly.
<i>execNumber</i>	0..1	RO	The number of times the instance should be executed, to be used when <i>execMode</i> indicates a repetition pattern.
<i>execReqArgs</i>	0..1 (L)	RO	Structured attribute (e.g. abstract type) to contain any command-specific arguments (as a list) used to trigger this <i><execInstance></i> .

9.6.18 Resource Type *node*

The *<node>* resource represents specific information that provides properties of an M2M Node that can be utilized by other oneM2M operations. The *<node>* resource has specialization of the *<mgmtObj>* as its child resources. These resources represent the Node's context information (e.g. memory and battery), network topology, device information, device capability etc. The specialized *<mgmtObj>* resources are used to perform management of the Node.

This node specific information stored in these resources such as *[memory]* and *[battery]* can be obtained either by the existing device management technologies (OMA DM [i.3], BBF TR-069 [i.2]) or any other way (e.g. JNI [i.18]).

For the case when the *<node>* resource belongs to an ADN, please see figure 9.6.18-1 in conjunction with the description of *nodeLink* attribute in the *<AE>* resource (clause 9.6.5).

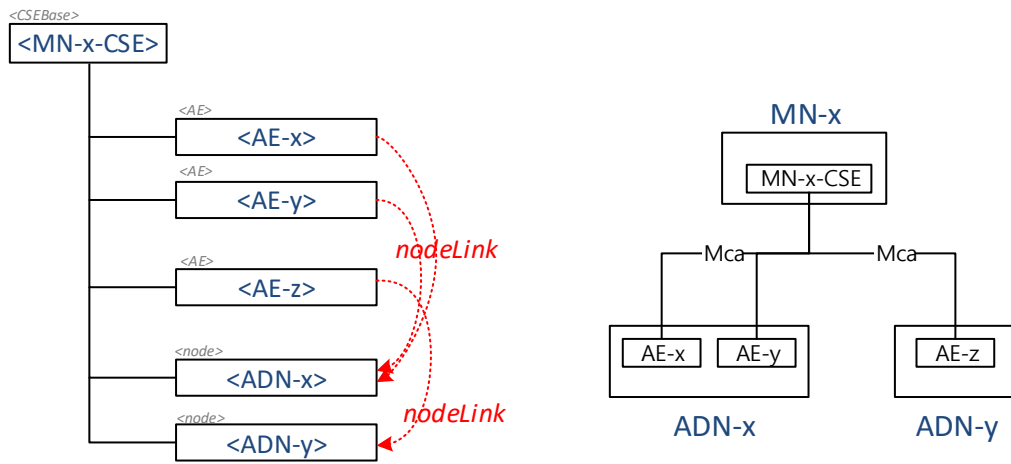

Figure 9.6.18-1: Relationship between MN and ADN

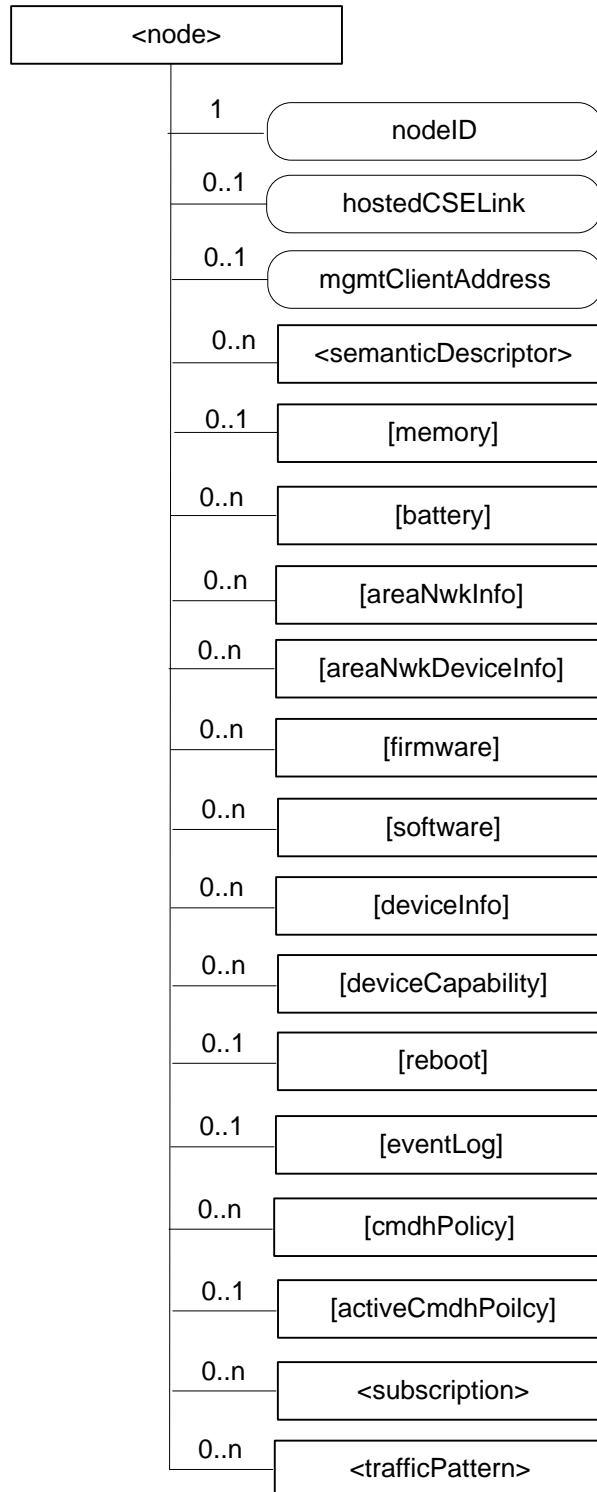

Figure 9.6.18-2: Structure of <node> resource

The <node> resource shall contain the child resources specified in table 9.6.18-1.

Table 9.6.18-1: Child resources of <node> resource

Child Resources of <node>	Child Resource Type	Multiplicity	Description	<nodeAnnc> Child Resource Type
[variable]	<semanticDescriptor>	0..n	See clause 9.6.30	<semanticDescriptor>, <semanticDescriptorAnnc>
[variable]	<mgmtObj> as defined in the specialization [memory]	0..1	This resource provides the memory (typically RAM) information of the node. (E.g. the amount of total volatile memory), See clause D.4.	<mgmtObjAnnc>
[variable]	<mgmtObj> as defined in the specialization [battery]	0..n	The resource provides the power information of the node. (E.g. remaining battery charge). See clause D.7.	<mgmtObjAnnc>
[variable]	<mgmtObj> as defined in the specialization [areaNwkInfo]	0..n	This resource describes the list of Nodes attached behind the MN node and its physical or underlying relation among the nodes in the M2M Area Network. This attribute is defined in case the Node is MN. See clause D.5.	<mgmtObjAnnc>
[variable]	<mgmtObj> as defined in the specialization [areaNwkDeviceInfo]	0..n	This resource describes the information about the Node in the M2M Area Network. See clause D.6.	<mgmtObjAnnc>
[variable]	<mgmtObj> as defined in the specialization [firmware]	0..n	This resource describes the information about the firmware of the Node include name, version etc. See clause D.2.	<mgmtObjAnnc>
[variable]	<mgmtObj> as defined in the specialization [software]	0..n	This resource describes the information about the software of the Node. See clause D.3.	<mgmtObjAnnc>
[variable]	<mgmtObj> as defined in the specialization [deviceInfo]	0..n	The resource contains information about the identity, manufacturer and model number of the device. See clause D.8.	<mgmtObjAnnc>
[variable]	<mgmtObj> as defined in the specialization [deviceCapability]	0..n	The resource contains information about the capability supported by the Node. See clause D.9.	<mgmtObjAnnc>
[variable]	<mgmtObj> as defined in the specialization [reboot]	0..1	The resource is the place to reboot or reset the Node. See clause D.10.	<mgmtObjAnnc>
[variable]	<mgmtObj> as defined in the specialization [eventLog]	0..1	The resource contains the information about the log of events of the Node. See clause D.11.	<mgmtObjAnnc>
[variable]	<mgmtObj> as defined in the specialization [cmdhPolicy]	0..n	The resource(s) contain(s) information about CMDH policies that are applicable to the CMDH processing on the CSE hosted on the node represented by this <node> resource and identified by the hostedCSELink attribute of this <node> resource. See clause D.12.	NA
[variable]	<mgmtObj> as defined in the specialization [activeCmdhPolicy]	0..1	This resource defines which of the present [cmdhPolicy] resource(s) shall be active for the CMDH processing on the CSE hosted on the node represented by this <node> resource and identified by the hostedCSELink attribute of this <node> resource. See clause D.12.	NA
[variable]	<subscription>	0..n	See clause 9.6.8.	<subscription>
trafficPattern	<trafficPattern>	0..n	See clause 9.6.41.	<trafficPatternAnnc>

The <node> resource shall contain the attributes specified in table 9.6.18-2.

Table 9.6.18-2: Attributes of <node> resource

Attributes of <node>	Multiplicity	RW/RO/WO	Description	<nodeAnnnc> attributes
<i>resourceType</i>	1	RO	See clause 9.6.1.3.	NA
<i>resourceID</i>	1	RO	See clause 9.6.1.3.	NA
<i>resourceName</i>	1	WO	See clause 9.6.1.3.	NA
<i>parentID</i>	1	RO	See clause 9.6.1.3.	NA
<i>expirationTime</i>	1	RW	See clause 9.6.1.3.	MA
<i>accessControlPolicyIDs</i>	0..1 (L)	RW	See clause 9.6.1.3.	MA
<i>creationTime</i>	1	RO	See clause 9.6.1.3.	NA
<i>lastModifiedTime</i>	1	RO	See clause 9.6.1.3.	NA
<i>labels</i>	0..1 (L)	RW	See clause 9.6.1.3.	MA
<i>announceTo</i>	0..1 (L)	RW	See clause 9.6.1.3.	NA
<i>announcedAttribute</i>	0..1 (L)	RW	See clause 9.6.1.3.	NA
<i>dynamicAuthorizationConsultationIDs</i>	0..1 (L)	RW	See clause 9.6.1.3.	OA
<i>nodeID</i>	1	RW	The M2M-Node-ID of the node which is represented by this <node> resource.	MA
<i>hostedCSELink</i>	0..1	RW	The <i>hostedCSELink</i> attribute allows to find the <CSEBase> or <remoteCSE> resource representing the CSE that is residing on the node that is represented by this <node> resource. The attribute contains the resource ID of a resource where all of the following applies: <ul style="list-style-type: none"> The resource is a <CSEBase> resource or a <remoteCSE> resource. The resource represents the CSE which resides on the specific node that is represented by the current <node> resource. In case the node that is represented by this <node> resource does not contain a CSE, this attribute shall not be present.	OA
<i>mgmtClientAddress</i>	0..1	RW	Represents the physical address of management client of the node which is represented by this <node> resource. This attribute is absent if management server is able to acquire the physical address of the management client.	OA

9.6.19 Resource Type *m2mServiceSubscriptionProfile*

The *<m2mServiceSubscriptionProfile>* resource represents an M2M Service Subscription. It is used to represent all data pertaining to the M2M Service Subscription, i.e. the technical part of the contract between an M2M Application Service Provider and an M2M Service Provider and is only stored on IN-CSE. The data is also represented in *<serviceSubscribedNode>* and *<serviceSubscribedAppRule>* resources as well as *<m2mServiceSubscriptionProfile>* resource. The relationship among those three resource types are depicted as follows. Note that the diagram does not capture all attributes and child resources. Those resource types shall only be instantiated on IN-CSE.

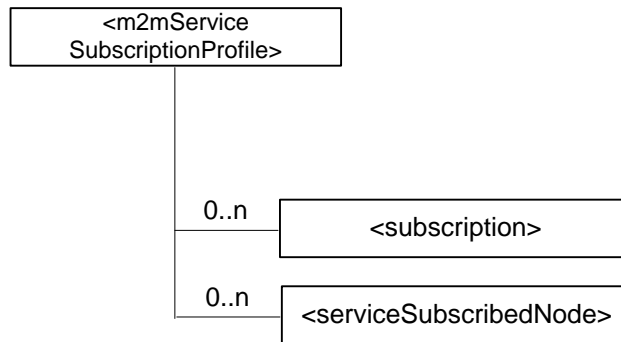

Figure 9.6.19-1: Structure of *<m2mServiceSubscriptionProfile>* resource

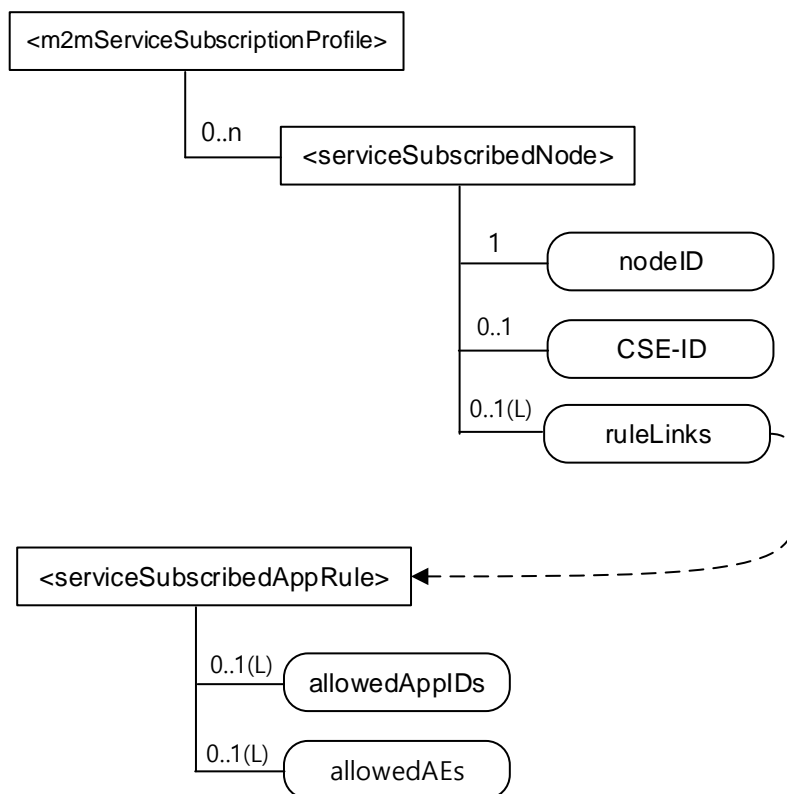

Figure 9.6.19-2: Relationship among M2M Service Subscription related resources

The *<m2mServiceSubscriptionProfile>* resource shall contain the child resources specified in table 9.6.19-1.

Table 9.6.19-1: Child resources of *<m2mServiceSubscriptionProfile>* resource

Child Resources of <i><m2mServiceSubscriptionProfile></i>	Child Resource Type	Multiplicity	Description
[variable]	<i><subscription></i>	0..n	See clause 9.6.8
[variable]	<i><serviceSubscribedNode></i>	0..n	See clause 9.6.20

The `<m2mServiceSubscriptionProfile>` resource shall contain the attributes specified in table 9.6.19-2.

Table 9.6.19-2: Attributes of `<m2mServiceSubscriptionProfile>` resource

Attributes of <code><m2mServiceSubscriptionProfile></code>	Multiplicity	RW/RO/WO	Description
<code>resourceType</code>	1	RO	See clause 9.6.1.3.
<code>resourceID</code>	1	RO	See clause 9.6.1.3.
<code>resourceName</code>	1	WO	See clause 9.6.1.3.
<code>parentID</code>	1	RO	See clause 9.6.1.3.
<code>expirationTime</code>	1	RW	See clause 9.6.1.3.
<code>accessControlPolicyIDs</code>	0..1 (L)	RW	See clause 9.6.1.3. If no <code>accessControlPolicyIDs</code> value is configured, the <code>accessControlPolicyIDs</code> of the parent resource shall be applied for privilege checking.
<code>creationTime</code>	1	RO	See clause 9.6.1.3.
<code>labels</code>	0..1 (L)	RW	See clause 9.6.1.3.
<code>lastModifiedTime</code>	1	RO	See clause 9.6.1.3.
<code>dynamicAuthorizationConsultationIDs</code>	0..1 (L)	RW	See clause 9.6.1.3.

9.6.20 Resource Type `serviceSubscribedNode`

The `<serviceSubscribedNode>` resource represents M2M Node information that is needed as part of the M2M Service Subscription resource and is only stored on IN-CSE. It contain M2M-Node-ID and optionally CSE-ID running on that Node.

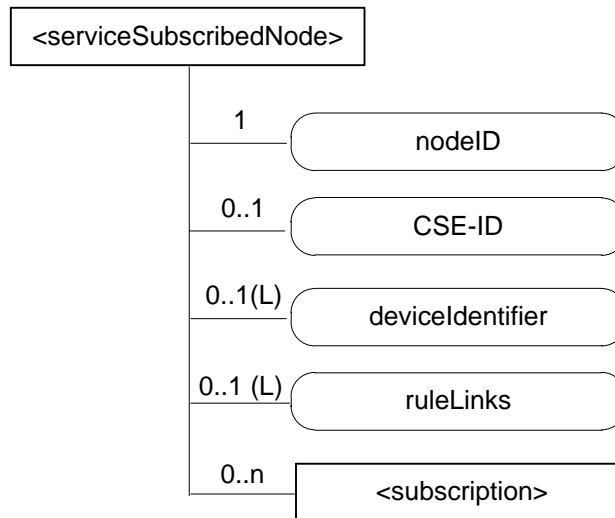

Figure 9.6.20-1: Structure of `<serviceSubscribedNode>` resource

The `<serviceSubscribedNode>` resource shall contain the child resource specified in table 9.6.20-1.

Table 9.6.20-1: Child resources of `<serviceSubscribedNode>` resource

Child Resources of <code><serviceSubscribedNode></code>	Child Resource Type	Multiplicity	Description
[variable]	<code><subscription></code>	0..n	See clause 9.6.8

The <serviceSubscribedNode> resource shall contain the attributes specified in table 9.6.20-2.

Table 9.6.20-2: Attributes of <serviceSubscribedNode> resource

Attributes of <serviceSubscribedNode>	Multiplicity	RW/RO/WO	Description
resourceType	1	RO	See clause 9.6.1.3.
resourceID	1	RO	See clause 9.6.1.3.
resourceName	1	WO	See clause 9.6.1.3.
parentID	1	RO	See clause 9.6.1.3.
expirationTime	1	RW	See clause 9.6.1.3.
accessControlPolicyIDs	0..1 (L)	RW	See clause 9.6.1.3. If no accessControlPolicyIDs value is configured, the accessControlPolicyIDs of the parent resource shall be applied for privilege checking.
creationTime	1	RO	See clause 9.6.1.3.
labels	0..1 (L)	RW	See clause 9.6.1.3.
lastModifiedTime	1	RO	See clause 9.6.1.3.
dynamicAuthorizationConsultationIDs	0..1 (L)	RW	See clause 9.6.1.3.
nodeID	1	WO	M2M-Node-ID of the node that is represented by this instance.
CSE-ID	0..1	WO	CSE-ID pertaining to this node (for nodes that have a CSE).
deviceIdentifier	0..1 (L)	WO	A list of device identifiers that uniquely identify a device. The format of a device identifier is one of the following: <ul style="list-style-type: none"> • Case 1: Identify a device using the format <OUI> "-" <ProductClass> "-" <SerialNumber> as defined in section 3.4.4 of BBF TR-069 [i.2]. The format of the URN is urn:dev:ops:<OUI> "-" <ProductClass> "-" <SerialNumber>. • Case 2: Identify a device using the format <OUI> "-" <SerialNumber> as defined in section 3.4.4 of BBF TR-069 [i.2]. The format of the URN is urn:dev:os:<OUI> "-" <SerialNumber>. • Case 3: Identify a device using an International Mobile Equipment Identifiers of 3GPP TS 23 003 [i.23]. This URN specifies a valid, 15 digit IMEI. The format of the URN is urn:imei:#####. • Case 4: Identify a device using an Electronic Serial Number. The ESN specifies a valid, 8 digit ESN. The format of the URN is urn:esn:#####. • Case 5: Identify a device using a Mobile Equipment Identifier. This URN specifies a valid, 14 digit MEID. The format of the URN is urn:meid:#####. • Case 6: Identify a device using an Object Identifier (OID). This URN specifies a valid OID - see Annex H for one possible naming convention. The format of the URN is urn:oid:<OID>. • Case 7: Identify a device using a Universally Unique Identifier (UUID). The UUID specifies a valid, hex digit character string as defined in IETF RFC 4122 [i.26]. The format of the URN is urn:uuid:#####-####-####-#####.
ruleLinks	0..1 ((L))	RW	This attribute contains a list of links towards <serviceSubscribedAppRule> resources pertaining to this <serviceSubscribedNode>. See clause 9.6.29 for an explanation of the <serviceSubscribedAppRule> resource. This attribute shall exist only when the CSE-ID attribute is present. When the list is empty, it means no applications are allowed to register on the CSE which is indicated by the CSE-ID attribute.

9.6.21 Resource Type *pollingChannel*

The *<pollingChannel>* resource represents a channel that can be used for a request-unreachable entity (i.e. an AE or a CSE which is behind NAT so it cannot receive a request from other Nodes). The request-unreachable entity creates a *<pollingChannel>* resource on a request-reachable CSE, and then polls any type of request(s) for itself from the *<pollingChannel>* Hosting CSE.

EXAMPLE: An AE can retrieve notifications by long polling on the channel when it cannot receive notifications asynchronously from a subscription Hosting CSE.

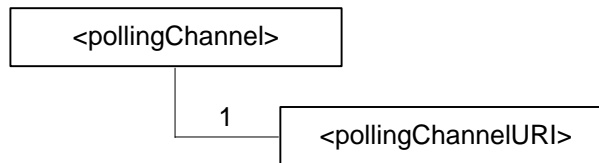

Figure 9.6.21-1: Structure of *<pollingChannel>* resource

The *<pollingChannel>* resource shall contain the child resource specified in table 9.6.21-1.

Table 9.6.21-1: Child resources of *<pollingChannel>* resource

Child Resources of <i><pollingChannel></i>	Child Resource Type	Multiplicity	Description
<i>pcu</i>	<i><pollingChannelURI></i>	1	See clause 9.6.22

The *<pollingChannel>* resource shall contain the attributes specified in table 9.6.21-2.

Table 9.6.21-2: Attributes of *<pollingChannel>* resource

Attributes of <i><pollingChannel></i>	Multiplicity	RW/RO/WO	Description
<i>resourceType</i>	1	RO	See clause 9.6.1.3.
<i>resourceID</i>	1	RO	See clause 9.6.1.3.
<i>resourceName</i>	1	WO	See clause 9.6.1.3.
<i>parentID</i>	1	RO	See clause 9.6.1.3.
<i>creationTime</i>	1	RO	See clause 9.6.1.3.
<i>lastModifiedTime</i>	1	RO	See clause 9.6.1.3.
<i>expirationTime</i>	1	RO	See clause 9.6.1.3.
<i>labels</i>	0..1 (L)	RW	See clause 9.6.1.3.

9.6.22 Resource Type *pollingChannelURI*

The *<pollingChannelURI>* virtual resource is the child resource of the *<pollingChannel>* resource and is used to perform service layer long polling. The AE or CSE which created the *<pollingChannel>* resource on its Registrar CSE sends a Retrieve request targeting the *<pollingChannelURI>* resource as a service layer long polling request. The response to the long polling request shall be pending until there are any requests received on the channel or the request reaches the request expiration time.

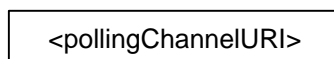

Figure 9.6.22-1: Structure of *<pollingChannelURI>* resource

9.6.23 Resource Type *statsConfig*

The *<statsConfig>* resource is used to store policies of statistics for AEs. The *<statsConfig>* resource may be established by the IN-CSEs or by IN-AEs. The *<statsConfig>* resource shall be located directly under *<CSEBase>*.

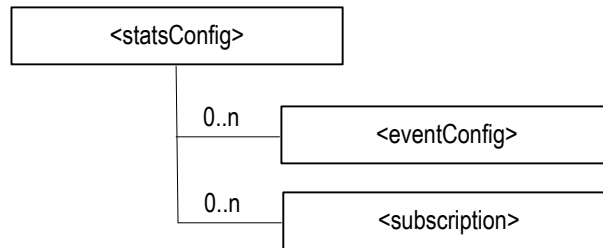

Figure 9.6.23-1: Structure of *<statsConfig>* resource

The *<statsConfig>* resource shall contain the child resources specified in table 9.6.23-1.

Table 9.6.23-1: Child resources of *<statsConfig>* resource

Child Resources of <i><statsConfig></i>	Child Resource Type	Multiplicity	Description
[variable]	<i><eventConfig></i>	0..n	See clause 9.6.24. This resource configures an event for statistics collection.
[variable]	<i><subscription></i>	0..n	See clause 9.6.8 where the type of this resource is described.

The *<statsConfig>* resource shall contain the attributes specified in table 9.6.23-2.

Table 9.6.23-2: Attributes of *<statsConfig>* resource

Attributes of <i><statsConfig></i>	Multiplicity	RW/RO/WO	Description
<i>resourceType</i>	1	RO	See clause 9.6.1.3
<i>resourceID</i>	1	RO	See clause 9.6.1.3
<i>resourceName</i>	1	WO	See clause 9.6.1.3
<i>parentID</i>	1	RO	See clause 9.6.1.3
<i>accessControlPolicyIDs</i>	0..1 (L)	RW	See clause 9.6.1.3
<i>creationTime</i>	1	RO	See clause 9.6.1.3
<i>expirationTime</i>	1	RW	See clause 9.6.1.3
<i>lastModifiedTime</i>	1	RO	See clause 9.6.1.3
<i>labels</i>	0..1 (L)	RW	See clause 9.6.1.3
<i>dynamicAuthorizationConsultationIDs</i>	0..1 (L)	RW	See clause 9.6.1.3
<i>creator</i>	0..1	RO	See clause 9.6.1.3

9.6.24 Resource Type *eventConfig*

<eventConfig> sub-resource shall be used to define events that trigger statistics collection. Below are some examples of events that can be generated:

- Collection based on a certain operation: collects any RETRIEVE operations on the data (i.e. resources) stored in the IN-CSE.
- Collection based on storage size: collects the size of storage when a "Content Sharing Resource" stored in the IN-CSE exceeds a quota.
- Combined configuration: collects all RETRIEVE operations on the data stored in the IN-CSE during a period of time.

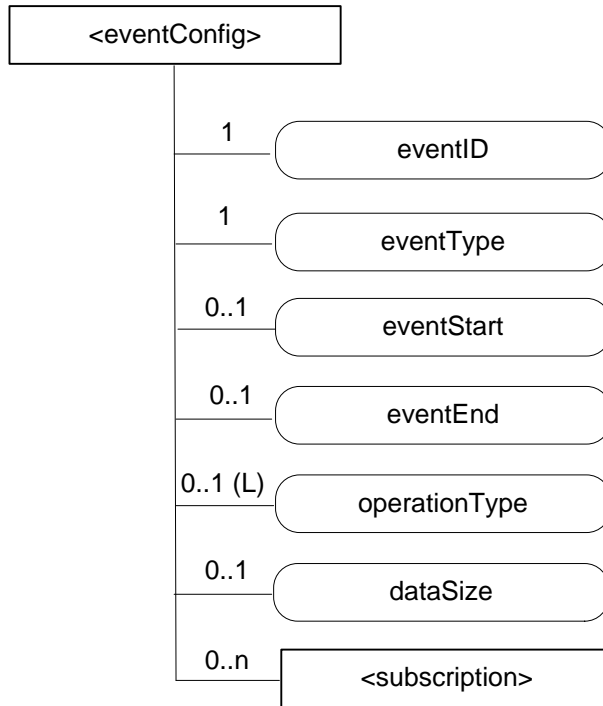

Figure 9.6.24-1: Structure of <eventConfig> resource

The <eventConfig> resource shall contain the child resource specified in table 9.6.24-1.

Table 9.6.24-1: Child resources of <eventConfig> resource

Child Resources of <eventConfig>	Child Resource Type	Multiplicity	Description
[variable]	<subscription>	0..n	See clause 9.6.8 where this type of resource is described.

The <eventConfig> resource shall contain the attributes specified in table 9.6.24-2.

Table 9.6.24-2: Attributes of <eventConfig> resource

Attributes of <eventConfig>	Multiplicity	RW/RO/WO	Description
resourceType	1	RO	See clause 9.6.1.3.
resourceID	1	RO	See clause 9.6.1.3.
resourceName	1	WO	See clause 9.6.1.3.
parentID	1	RO	See clause 9.6.1.3.
accessControlPolicyIDs	0..1 (L)	RW	See clause 9.6.1.3.
creationTime	1	RO	See clause 9.6.1.3.
expirationTime	1	RW	See clause 9.6.1.3.
lastModifiedTime	1	RO	See clause 9.6.1.3.
labels	0..1 (L)	RW	See clause 9.6.1.3.
dynamicAuthorizationConsultationIDs	0..1 (L)	RW	See clause 9.6.1.3.
creator	0..1	RO	See clause 9.6.1.3.
eventID	1	RO	This attribute uniquely identifies the event to be collected for statistics for AEs.
eventType	1	RW	This attribute indicates the type of the event:timer based, data operation, or storage based.
eventStart	0..1	RW	This attribute indicates the start time of the event.
eventEnd	0..1	RW	This attribute indicates the end time of the event
operationType	0..1 (L)	RW	This attribute defines the type of the operation to be collected by statistics, such as CREATE, RETRIEVE.
dataSize	0..1	RW	This attribute defines the data size that will trigger a storage based event. For <container> and <timeSeries> <i>currentByteSize</i> is compared. For <contentInstance>, <flexContainer>, <timeSeriesInstance> <i>contentSize</i> is compared. An event is triggered when the compared data size exceeds <i>dataSize</i> size.

9.6.25 Resource Type *statsCollect*

The *<statsCollect>* resource shall be used to collect information for AEs using the *<eventConfig>* resource as the triggers in the IN-CSE. Multiple triggers can be established at IN-CSE for the same AE. Each trigger may be activated or de-activated independently of others. The *<statsCollect>* resource shall be located directly under *<CSEBase>* of IN-CSE.

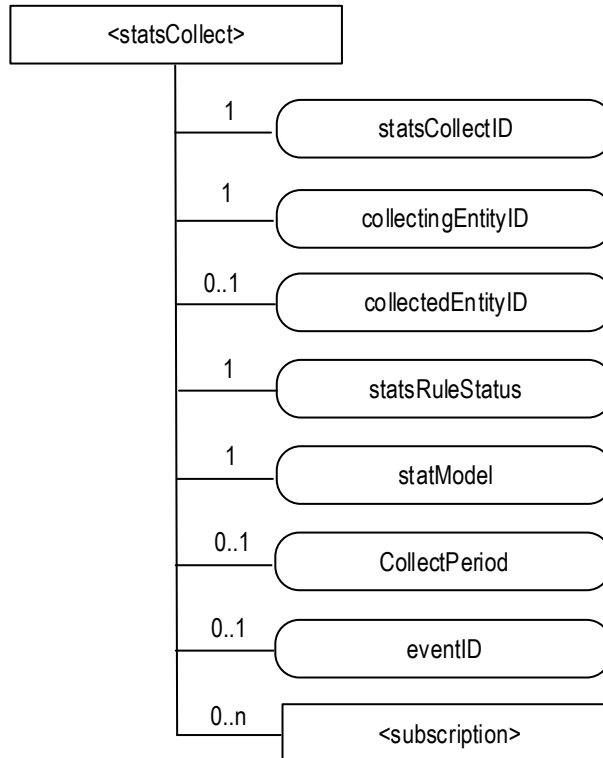

Figure 9.6.25-1: Structure of *<statsCollect>* resource

The *<statsCollect>* resource shall contain the child resource specified in table 9.6.25-1.

Table 9.6.25-1: Child resources of *<statsCollect>* resource

Child Resources of <i><statsCollect></i>	Child Resource Type	Multiplicity	Description
[variable]	<i><subscription></i>	0..n	See clause 9.6.8 where the type of this resource is described.

The <statsCollect> resource shall contain the attributes specified in table 9.6.25-2.

Table 9.6.25-2: Attributes of <statsCollect> resource

Attributes of <statsCollect>	Multiplicity	RW/RO/WO	Description
resourceType	1	RO	See clause 9.6.1.3
resourceID	1	RO	See clause 9.6.1.3.
resourceName	1	WO	See clause 9.6.1.3.
parentID	1	RO	See clause 9.6.1.3.
accessControlPolicyIDs	0..1 (L)	RW	See clause 9.6.1.3.
creationTime	1	RO	See clause 9.6.1.3.
expirationTime	1	RW	See clause 9.6.1.3.
lastModifiedTime	1	RO	See clause 9.6.1.3.
labels	0..1 (L)	RW	See clause 9.6.1.3.
dynamicAuthorizationConsultationIDs	0..1 (L)	RW	See clause 9.6.1.3.
creator	0..1	RO	See clause 9.6.1.3.
statsCollectID	1	RO	This is the unique ID to identify a specific statistics collection scenario. It is created by the IN-CSE when the <statsCollect> resource is first created.
collectingEntityID	1	WO	This is the unique ID of the entity that requests the collection of statistics. For example, it can be an AE-ID or CSE-ID.
collectedEntityID	0..1	WO	This is the unique ID of the entity whose request triggered the configured event for statistics collection. For example, it can be an AE-ID or IN-CSE-ID. If no specific value is provided for this attribute, the IN-CSE interprets it as "any entity".
statsRuleStatus	1	RW	This attribute indicates whether the rule is "active" or "inactive".
statModel	1	RW	This attribute indicates the collection model, such as "Subscriber based", "event based", etc.
collectPeriod	0..1	RW	Expresses time periods defined by second, minute, hour day of month, month, and year. Supports repeating periods, and wildcards expressed as a list.
eventID	0..1	RW	This attribute refers to the <eventConfig> resource that defines the events that can be collected by the IN-CSE. It is mandatory if the statModel attribute is set to "event based".

9.6.26 Resource Announcement

9.6.26.1 Overview

A resource can be announced to one or more remote CSEs to inform the remote CSEs of the existence of the original resource. An announced resource can have a limited set of attributes and a limited set of child resources from the original resource. The announced resource includes a link to the original resource hosted by the original resource-Hosting CSE.

In case that the original resource is deleted, all announced resources for the original resource shall be deleted, except for <AEAnn> resources that were created during the registration of an AE with AE-ID-Stem starting with "S", which shall not be deleted. If the announced resource is not deleted promptly (e.g. the announced resource is not reachable), the announced resource can be deleted later either by the original resource Hosting CSE or by the expiration of the announced resource itself. The original resource shall store the list of links for the announced resources for those purposes.

Synchronization between the attributes announced by the original resource and the announced resource shall be the responsibility of the original resource Hosting CSE. There shall not be any synchronization for children created at the original resource and the announced resource. The access control policy for the announced resource shall synchronize with the one from the original resource. In case that the attribute *accessControlPolicyIDs* is not present in the original resource it is the responsibility of the original resource Hosting CSE to choose the appropriate value depending on the policy for the original resource (e.g. take the parent *accessControlPolicyIDs* value).

The original resource shall have at least *announceTo* attribute present if the resource itself has been announced. If any of the Optional Announced (OA) attributes are also announced, then *announcedAttribute* attribute shall also be present. An AE or other CSE can request the original resource Hosting CSE for announcing the original resource to the list of CSE-IDs or the address(es) listed in the *announceTo* attribute in the announcing request. An Update to the *announceTo* attribute will trigger new resource announcement(s) or the de-announcement(s) of the announced resource. After a successful announcement procedure the attribute *announceTo* contains only the list of address(es) of the announced resources.

In order to announce an attribute marked as **OA** (see clause 9.5.0), the attribute shall be included in the *announcedAttribute* attribute list at the original resource. The attributes included in the *announcedAttribute* attribute are announced to the announced resource. On successful announcement of the resource, such attributes shall be created at the announced resource; otherwise they shall not be present in the announced resource. Update to the *announcedAttribute* attribute in the original resource will trigger new attribute announcement or the de-announcement of the announced attribute(s). The announced attributes shall have the same value as the original resource, and synchronization between the value of the announced attributes at the original resource and the announced resource is the responsibility of the original resource Hosting CSE.

An announced resource may have child resources. In general, a child resource of an announced resource shall be of one of the resource types that are specified as possible child resource types for the original resource or of one of their associate announced resource types. However, for specific announced resource types, specific exceptions apply regarding which child resource types can occur. The details on which child resources are specified for each announced resource type are summarized in table 9.6.26.1-1.

Child resources of the original resource can be announced independently as needed. In this case, the child resources at the announced resource shall be of the child resource's associated announced type. When a child resource at the announced resource is created locally at the remote CSE, the child resource shall be of ordinary - i.e. not-announced - child resource type.

When a Hosting CSE of an original resource is initiating an announcement, it shall first check if the parent resource of the original resource has already been announced at the announcement target CSE. If that is the case, the announced resource shall be created as a child resource of that already announced representation of the parent resource. If that is not the case the Hosting CSE shall next check if it is registered to the announcement target CSE. If that is the case, the announced resource shall be created as a child of the *<remoteCSE>* resource representing the Hosting CSE of the original resource and hosted by the announcement target CSE. If that is not the case, the Hosting CSE shall announce itself to the announcement target CSE by creating a *<remoteCSEAnnc>* resource as a child of the *<CSEBase>* representing the announcement target CSE. The announced resource shall then be created as a child resource of the *<remoteCSEAnnc>* resource.

When a Hosting CSE of an original resource is initiating an announcement, the *From* parameter of the announce request shall contain either a SP-relative-CSE-ID of the Hosting CSE of the original resource if the announcement target CSE resides in the same SP domain or an Absolute-CSE-ID of the Hosting CSE of the original resource if the announcement target CSE resides in a different SP domain.

Note, parent child relationship of *<remoteCSEAnnc>* and the *<CSEBase>* resource of the announcement target CSE does not necessarily reflect the topology of the Hosting CSE of the original resource and the announcement target CSE.

If an attribute is marked as **RO** and also marked as **MA** or **OA**, then only the attribute of the original resource shall be interpreted as **RO**. The corresponding attribute of the announced resource shall be always writable to the original resource hosting CSE to allow it to properly announce and de-announce the attribute and keep the announced attribute synchronized with the original one. Only the original resource Hosting CSE shall be allowed to update and delete the announced attribute which is created by the original resource Hosting CSE.

Table 9.6.26.1-1: Announced Resource Types

Announced Resource Type	Short Description	Child Resource Types	Clause
<i>accessControlPolicyAnnc</i>	Announced variant of <i>accessControlPolicy</i>	<i>subscription</i>	9.6.2
<i>AEAnnc</i>	Announced variant of <i>AE</i>	<i>subscription, container, containerAnnc, flexContainer, flexContainerAnnc, group, groupAnnc, accessControlPolicy, accessControlPolicyAnnc, semanticDescriptor, semanticDescriptorAnnc, scheduleAnnc, trafficPatternAnnc, timeSeries, timeSeriesAnnc</i>	9.6.5
<i>containerAnnc</i>	Announced variant of <i>container</i>	<i>container, containerAnnc, flexContainer, flexContainerAnnc, contentInstance, contentInstanceAnnc, subscription, semanticDescriptor, semanticDescriptorAnnc</i>	9.6.6
<i>contentInstanceAnnc</i>	Announced variant of <i>contentInstance</i>	<i>semanticDescriptor, semanticDescriptorAnnc</i>	9.6.7
<i>flexContainerAnnc</i>	Announced variant of <i>flexContainer</i>	<i>container, containerAnnc, flexContainer, flexContainerAnnc, subscription, semanticDescriptor, semanticDescriptorAnnc</i>	9.6.35
<i>groupAnnc</i>	Announced variant of <i>group</i>	<i>subscription, semanticDescriptor, semanticDescriptorAnnc</i>	9.6.13
<i>locationPolicyAnnc</i>	Announced variant of <i>locationPolicy</i>	None specified	9.6.10
<i>mgmtObjAnnc</i>	Announced variant of <i>mgmtObj</i>	<i>subscription</i>	9.6.15
<i>nodeAnnc</i>	Announced variant of <i>node</i>	<i>mgmtObjAnnc, subscription, semanticDescriptor, semanticDescriptorAnnc, trafficPatternAnnc</i>	9.6.18
<i>remoteCSEAnnc</i>	Announced variant of <i>remoteCSE</i>	<i>container, containerAnnc, flexContainer, flexContainerAnnc, group, groupAnnc, accessControlPolicy, accessControlPolicyAnnc, subscription, scheduleAnnc, timeSeries, timeSeriesAnnc, remoteCSEAnnc, nodeAnnc, AEAnnc, locationPolicyAnnc</i>	9.6.4
<i>scheduleAnnc</i>	Announced variant of <i>schedule</i>	None specified	9.6.9
<i>trafficPatternAnnc</i>	Announced variant of <i>trafficPattern</i>	<i>scheduleAnnc, subscription</i>	9.6.41
<i>semanticDescriptorAnnc</i>	Announced variant of <i>semanticDescriptor</i>	<i>Subscription</i>	9.6.30

9.6.26.2 Universal Attributes for Announced Resources

Table 9.6.26.2-1 lists the universal attributes for the announced resources. If an attribute is marked "NA" in the original resource type or it is marked "OA" and is not provided by the Originator, then the value for the corresponding attribute in the announced resource is provided by the <remote CSE> resource.

Table 9.6.26.2-1: Universal Attributes for Announced Resources

Attributes Name	Mandatory /Optional	Description
<i>resourceType</i>	Mandatory	Resource Type. As specified in clause 9.2, a suffix of "Annc" to the name of the original resource type shall be used to indicate the name for the associated announced resource type.
<i>resourceID</i>	Mandatory	Identifies the resource at the remote CSE
<i>resourceName</i>	Mandatory	See clause 9.6.1.3 for information on this attribute
<i>parentID</i>	Mandatory	Identifies the parent resource at the remote CSE.
<i>creationTime</i>	Mandatory	See clause 9.6.1.3 for information on this attribute.
<i>lastModifiedTime</i>	Mandatory	See clause 9.6.1.3 for information on this attribute.
<i>expirationTime</i>	Mandatory	See clause 9.6.1.3.2 for information on this attribute. This attribute cannot exceed the value received from the original resource but it can be overridden by the policies of the remote CSE hosting the announced resource.
<i>link</i>	Mandatory	Provides the URI to the original resource.

9.6.26.3 Common Attributes for Announced Resources

Table 9.6.26.3-1 lists the common attributes for the announced resources.

Table 9.6.26.3-1: Commonly Used Attributes for Announced Resources

Attribute Name	Mandatory /Optional	Description
<i>accessControlPolicyIDs</i>	Conditionally Mandatory	The list of identifiers (either an ID or a URI) of an <accessControlPolicy> resource announced by the original resource See clause 9.6.1.3.2 for further information on this attribute. If this attribute was not present in the original resource, the original resource shall include this attribute by providing the <i>accessControlPolicyIDs</i> from the original resource's parent resource or from the local policy according at the original resource.
<i>stateTag</i>	Conditionally Mandatory	An incremental counter of modification on the resource. See clause 9.6.1.3.2 for information on this attribute.
<i>labels</i>	Conditionally Mandatory	Tokens used as keys for discovering resources as announced by the original resource. See clause 9.6.1.3 for further information on this attribute. The attribute is conditionally mandatory, which means that the attribute shall exist in the announced resource if it is present in the original resource.

9.6.27 Resource Type *latest*

The <latest> resource is a virtual resource because it does not have a representation. It is the child resource of a <container> resource. When a request addresses the <latest> resource, the Hosting CSE shall apply the request to the latest <contentInstance> resource among all existing <contentInstance> resources of the <container> resource.

The <latest> resource inherits access control policies that apply to the parent <container> resource.

9.6.28 Resource Type *oldest*

The *<oldest>* resource is a virtual resource because it does not have a representation. It is the child resource of a *<container>* resource. When a request addresses the *<oldest>* resource, the Hosting CSE shall apply the request to the oldest *<contentInstance>* resource among all existing *<contentInstance>* resources of the *<container>* resource.

The *<oldest>* resource inherits access control policies that apply to the parent *<container>* resource.

9.6.29 Resource Type *serviceSubscribedAppRule*

The *<serviceSubscribedAppRule>* resource represents a rule that defines allowed Role-ID, App-ID and AE-ID combinations that are acceptable for registering an AE on a Registrar CSE and is only stored on IN-CSE. The rule in a *<serviceSubscribedAppRule>* resource shall apply for CSEs for which the associated *<serviceSubscribeNode>* resource is linked with the *<serviceSubscribedAppRule>* via the *ruleLinks* attribute of the *<serviceSubscribeNode>* resource. The rule contained in a *<serviceSubscribedAppRule>* resource defines a mapping between:

- a) one or more Credential-ID(s); and
- b) combinations of one or more Role-ID(s), one or more App-ID(s) and one or more AE-ID(s) which are allowed to be used for registering AE(s) that issued a registration request via a Security Association established with the credentials associated with the Credential-ID(s) listed in (a).

When applications shall be allowed in situations where no Security Association has been established prior to issuing the registration request, the Credential-ID 'None' shall be used in the rule.

The parent resource of a *<serviceSubscribedAppRule>* resource is the *<CSEBase>* resource of the IN-CSE hosting the *<serviceSubscribeNode>* resource(s) that point to the *<serviceSubscribedAppRule>* resource.

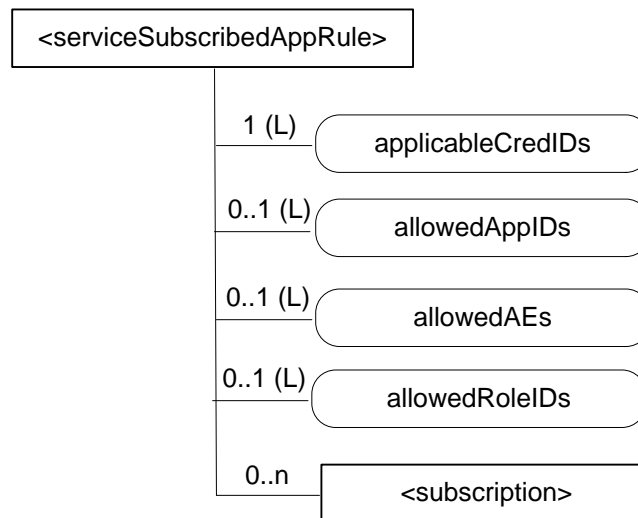

Figure 9.6.29-1: Structure of *<serviceSubscribedAppRule>* resource

The *<serviceSubscribedAppRule>* resource shall contain the child resource specified in table 9.6.29-1.

Table 9.6.29-1: Child resources of *<serviceSubscribedAppRule>* resource

Child Resources of <i><serviceSubscribedAppRule></i>	Child Resource Type	Multiplicity	Description
[variable]	<i><subscription></i>	0..n	See clause 9.6.8 where the type of this resource is described.

The <serviceSubscribedAppRule> resource shall contain the attributes specified in table 9.6.29-2.

Table 9.6.29-2: Attributes of <serviceSubscribedAppRule> resource

Attributes of <serviceSubscribedAppRule>	Multiplicity	RW/RO/WO	Description
resourceType	1	RO	See clause 9.6.1.3.
resourceID	1	RO	See clause 9.6.1.3.
resourceName	1	WO	See clause 9.6.1.3.
parentID	1	RO	See clause 9.6.1.3.
expirationTime	1	RW	See clause 9.6.1.3.
accessControlPolicyIDs	0..1 (L)	RW	See clause 9.6.1.3. If no accessControlPolicyIDs value is configured, the accessControlPolicyIDs of the parent resource shall be applied for privilege checking.
creationTime	1	RO	See clause 9.6.1.3.
labels	0..1 (L)	RW	See clause 9.6.1.3.
lastModifiedTime	1	RO	See clause 9.6.1.3.
dynamicAuthorizationConsultationIDs	0..1 (L)	RW	See clause 9.6.1.3.
applicableCredIDs	1 (L)	RW	List of credential IDs for which this rule is applicable, i.e. for registration requests coming into a CSE via a Security Association Endpoint (SEA) [2], that was authenticated using credentials that match with any of these credential-IDs, the current rule applies. This can contain a '*' for any credential ID or 'None' for not authenticated case. Also Wildcards within an element of this list are possible (e.g. 'C123*X' for any Credential ID that starts with 'C123' and ends with 'X') to define sets or ranges of Credential-IDs.
allowedApp-IDs	0..1 (L)	RW	List of App-IDs that shall be considered to be allowed for AE registration requests received via Security Association Endpoint (SEA) [2] associated with credentialID stored in the attribute applicableCredID. This can contain '*' for any App-ID. Also Wildcards within an element of this list are possible (e.g. 'C123*X' for any App-ID that starts with 'C123' and ends with 'X') to define sets or ranges of App-IDs.
allowedAEs	0..1 (L)	RW	List of allowed AE-ID-Stems to be used for the registering AEs. This can contain zero or more specific AE-ID-Stem values, 'S*' for any SP-Assigned AE-ID-Stem, 'C*' for any CSE-assigned AE-ID-Stem, or '*' for any AE-ID-Stem. Also Wildcards within an element of this list are possible (e.g. 'C123*X' for any AE-ID that starts with 'C123' and ends with 'X') to define sets or ranges of AE-ID-Stems.
allowedRole-IDs	0..1(L)	RW	List of Role-IDs that shall be considered to be allowed in Request operations.

9.6.30 Resource Type semanticDescriptor

The <semanticDescriptor> resource is used to store a semantic description pertaining to a resource and potentially sub-resources. Such a description may be provided according to ontologies. The semantic information is used by the semantic functionalities of the oneM2M system and is also available to applications or CSEs. [i.28] provides an informative example of a descriptor attribute.

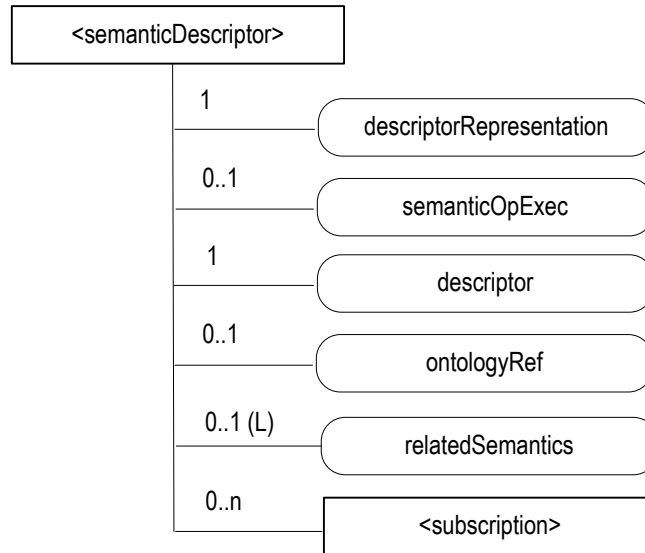

Figure 9.6.30-1: Structure of <semanticDescriptor> resource

The <semanticDescriptor> resource shall contain the child resources specified in table 9.6.30-1.

Table 9.6.30-1: Child resources of <semanticDescriptor> resource

Child Resources of <semanticDescriptor>	Child Resource Type	Multiplicity	Description	<semanticDescriptorAnnnc> Child Resource Types
[variable]	<subscription>	0..n	See clause 9.6.8 where the type of this resource is described.	<subscription>

The <*semanticDescriptor*> resource shall contain the attributes specified in table 9.6.23-2.

Table 9.6.30-2: Attributes of <*semanticDescriptor*> resource

Attributes of < <i>semanticDescriptor</i> >	Multiplicity	RW/RO/WO	Description	< <i>semanticDescriptorAnnnc</i> > Attributes
<i>resourceType</i>	1	RO	See clause 9.6.1.3.	NA
<i>resourceID</i>	1	RO	See clause 9.6.1.3.	NA
<i>resourceName</i>	1	WO	See clause 9.6.1.3.	NA
<i>parentID</i>	1	RO	See clause 9.6.1.3.	NA
<i>accessControlPolicyIDs</i>	0..1 (L)	RW	See clause 9.6.1.3.	MA
<i>creationTime</i>	1	RO	See clause 9.6.1.3.	NA
<i>expirationTime</i>	1	RW	See clause 9.6.1.3.	MA
<i>lastModifiedTime</i>	1	RO	See clause 9.6.1.3.	NA
<i>labels</i>	0..1 (L)	RW	See clause 9.6.1.3.	MA
<i>announceTo</i>	0..1 (L)	RW	See clause 9.6.1.3.	NA
<i>announcedAttribute</i>	0..1 (L)	RW	See clause 9.6.1.3.	NA
<i>dynamicAuthorizationConsultationIDs</i>	0..1 (L)	RW	See clause 9.6.1.3.	OA
<i>creator</i>	0..1	RO	See clause 9.6.1.3.	NA
<i>descriptorRepresentation</i>	1	RW	Indicates the type used for the serialization of the descriptor attribute, e.g. RDF serialized in XML.	OA
<i>semanticOpExec</i>	0..1	RW	This attribute cannot be retrieved. Contains a SPARQL query request for execution of semantic operations on the <i>descriptor</i> attribute e.g. SPARQL update as described in oneM2M TS-0004 [3].	NA
<i>descriptor</i>	1	RW	Stores a semantic description pertaining to a resource and potentially sub-resources. Such a description shall be according to subject-predicate-object triples as defined in the RDF graph-based data model [4]. The encoding of the RDF triples used in oneM2M is defined in oneM2M TS-0004 [3]. The elements of such triples may be provided according to ontologies. Examples of such descriptors in RDF can be found in [i.28].	OA
<i>ontologyRef</i>	0..1	WO	A reference (URI) of the ontology used to represent the information that is stored in the <i>descriptor attribute</i> . If this attribute is not present, the <i>ontologyRef</i> from the parent resource is used if present.	OA
<i>relatedSemantics</i>	0..1(L)	WO	List of URIs for resources containing related semantic information to be used in processing semantic queries. The URI(s) may reference either a < <i>group</i> > resource or other < <i>semanticDescriptor</i> > resources.	OA

9.6.31 Resource Type *notificationTargetMgmtPolicyRef*

The <*notificationTargetMgmtPolicyRef*> resource is a child resource of a <subscription> resource and lists a reference to the policy to be followed by the hosting CSE for every Target Notification of a subscription. The policy is applied by the hosting CSE when it receives a request to stop receiving a notification from a Target Notification. If no policy is defined for the Target Notification, then the hosting CSE shall apply the default policy. The default policy is either created by the subscription originator or the hosting CSE shall have a system created default one to apply. The system created default policy shall be configurable by the M2M Service Provider.

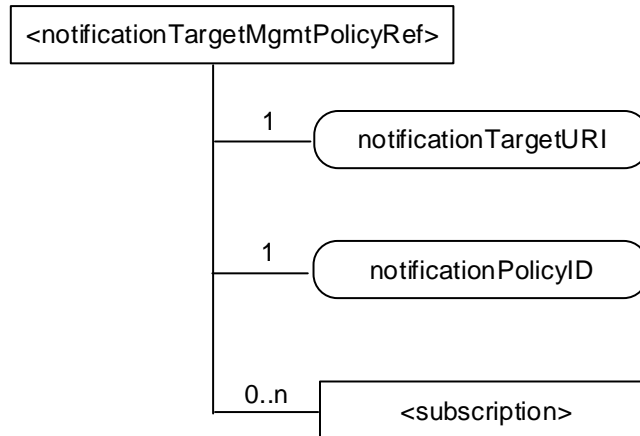

Figure 9.6.31-1: Structure of *<notificationTargetMgmtPolicyRef>* resource

Table 9.6.31-1: Child resources of *<notificationTargetMgmtPolicyRef>* resource

Child Resources of <i><notificationTargetMgmtPolicyRef></i> [variable]	Child Resource Type	Multiplicity	Description
	<i><subscription></i>	0..n	See clause 9.6.8

Table 9.6.31-2: Attributes of *<notificationTargetMgmtPolicyRef>* resource

Attributes of <i><notificationTargetMgmtPolicyRef></i>	Multiplicity	RW/ RO/ WO	Description
<i>resourceType</i>	1	RO	See clause 9.6.1.3.
<i>resourceID</i>	1	RO	See clause 9.6.1.3.
<i>resourceName</i>	1	WO	See clause 9.6.1.3.
<i>parentID</i>	1	RO	See clause 9.6.1.3.
<i>expirationTime</i>	1	RW	See clause 9.6.1.3.
<i>accessControlPolicyIDs</i>	0..1 (L)	RW	See clause 9.6.1.3. If no <i>accessControlPolicyIDs</i> value is configured, the <i>accessControlPolicyIDs</i> of the parent resource shall be applied for privilege checking.
<i>creationTime</i>	1	RO	See clause 9.6.1.3.
<i>labels</i>	0..1 (L)	RW	See clause 9.6.1.3.
<i>lastModifiedTime</i>	1	RO	See clause 9.6.1.3.
<i>dynamicAuthorizationConsultationIDs</i>	0..1 (L)	RW	See clause 9.6.1.3.
<i>notificationTargetURI</i>	1 (L)	RW	address(es) of the resource subscriber receiving a notification. The notificationTarget URI shall be listed in the <i>notificationURI</i> attribute of the parent <i><subscription></i> resource, otherwise the default Notification Target policy shall apply.
<i>notificationPolicyID</i>	0..1	RW	A link to the <i><notificationTargetPolicy></i> resource applicable to the notificationTargetURI. If none is specified than the default policy shall apply to the targetNotificationURI. See clause 9.6.32 for an explanation of the <i><notificationTargetPolicy></i> resource.

9.6.32 Resource Type *notificationTargetPolicy*

The *<notificationTargetPolicy>* resource is a child resource of *<CSEBase>* resource and lists the policies to be applied by the hosting CSE. A policy has a rules(s), represented by the *<policyDeletionRules>* and an action. The action is applied when the rules in the policy are fulfilled.

Rules are grouped in 2 groups to support a combination of rules for flexibility e.g. ((rule 1 AND rule 2) OR rule 3). A maximum of two groups of <policyDeletionRules> can be defined. The relationship to be applied between the 2 groups (AND/OR) shall be defined in the ruleRelationship attribute. If no rules are defined for a <notificationTargetPolicy> then the action is executed.

Each policy has the policyLabel which can take any form. There shall be at minimum a single notificationTargetPolicy which can be defined by the subscription originator with the label "default" to be applied when no specific policy is defined for a Target Notification. If a default policy is required and none is defined by the subscription originator then the system defined default policy shall be applied.

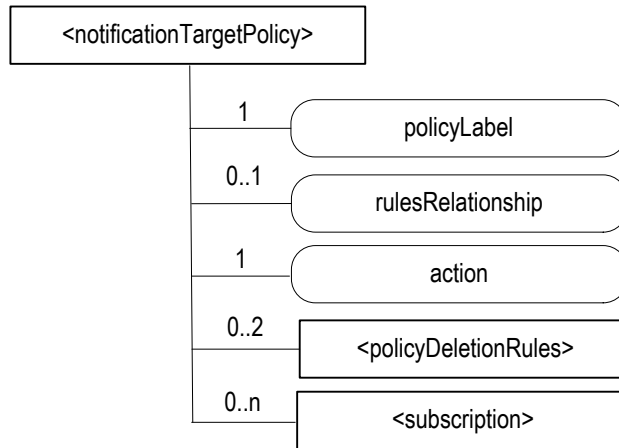

Figure 9.6.32-1: Structure of <notificationTargetPolicy> resource

Table 9.6.32-1: Child resources of <notificationTargetPolicy> resource

Child Resources of <notificationTargetPolicy>	Child Resource Type	Multiplicity	Description
[variable]	<policyDeletionRules>	0..2	Groups listing the rules that apply to this policy and that needs to be fulfilled for the listed action to take place, Only two groups of rules shall be supported. See clause 9.6.33.
[variable]	<subscription>	0..n	See clause 9.6.8.

Table 9.6.32-2: Attributes of <notificationTargetPolicy> resource

Attributes of <notificationTargetPolicy>	Multiplicity	RW/RO/WO	Description
resourceType	1	RO	See clause 9.6.1.3.
resourceID	1	RO	See clause 9.6.1.3.
resourceName	1	WO	See clause 9.6.1.3.
parentID	1	RO	See clause 9.6.1.3.
expirationTime	1	RW	See clause 9.6.1.3.
accessControlPolicyIDs	0..1 (L)	RW	See clause 9.6.1.3. If no accessControlPolicyIDs value is configured, the accessControlPolicyIDs of the parent resource shall be applied for privilege checking.
creationTime	1	RO	See clause 9.6.1.3.
labels	0..1 (L)	RW	See clause 9.6.1.3.
lastModifiedTime	1	RO	See clause 9.6.1.3.
dynamicAuthorizationConsultationIDs	0..1 (L)	RW	See clause 9.6.1.3.
creator	0..1	RO	See clause 9.6.1.3.
action	1	RW	Defines the action to be performed if the groups of rules are fulfilled. The action includes one of the following; accept request, reject request, seek authorization from subscription originator before responding, or inform the subscription originator without taking any action.
policyLabel	1	RW	At minimum a default policy shall be specified. The policyLabel "Default" shall be used in this case.
rulesRelationship	0..1	RW	Shall be either AND or OR This attribute is mandatory if more than one policy DeletionRule is specified.

9.6.33 Resource Type policyDeletionRules

The <policyDeletionRules> resource lists the rules to be applied by the hosting CSE during policy execution. Each <policyDeletionRules> can define any number of rules with an AND or OR relationship to be applied between them. The attribute deletionRulesRelation define the relationship between rules. It can have an AND or OR value.

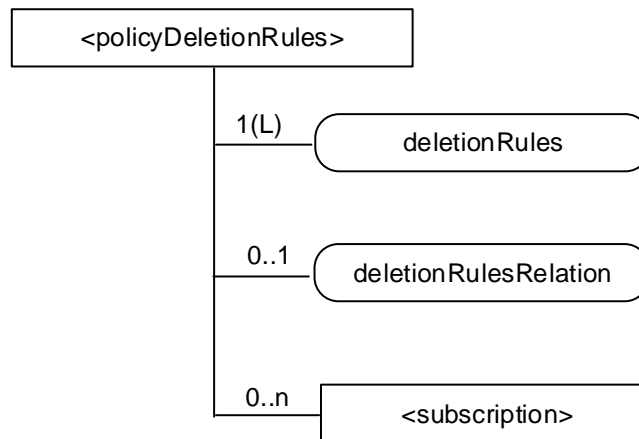

Figure 9.6.33-1: Structure of <policyDeletionRules> resource

Table 9.6.33-1: Child resources of <policyDeletionRules> resource

Child Resources of <policyDeletionRules>	Child Resource Type	Multiplicity	Description
[variable]	<subscription>	0..n	See clause 9.6.8

Table 9.6.33-2: Attributes of <policyDeletionRules> resource

Attributes of <policyDeletionRules>	Multiplicity	RW/RO/WO	Description
resourceType	1	RO	See clause 9.6.1.3.
resourceID	1	RO	See clause 9.6.1.3.
resourceName	1	WO	See clause 9.6.1.3.
parentID	1	RO	See clause 9.6.1.3.
expirationTime	1	RW	See clause 9.6.1.3.
accessControlPolicyIDs	0..1 (L)	RW	See clause 9.6.1.3. If no accessControlPolicyIDs value is configured, the accessControlPolicyIDs of the parent resource shall be applied for privilege checking.
creationTime	1	RO	See clause 9.6.1.3.
labels	0..1 (L)	RW	See clause 9.6.1.3.
lastModifiedTime	1	RO	See clause 9.6.1.3.
dynamicAuthorizationConsultationIDs	0..1 (L)	RW	See clause 9.6.1.3.
deletionRules	0..1(L)	RW	Lists the applicable rules. The rules include at minimum ; time of the day, geographical location of the Target Notification. Where the rule applies.
deletionRulesRelation	0..1	RW	Defines the relation to be applied between the deletionRules. This shall be either AND or OR.

9.6.34 Resource Type *notificationTargetSelfReference*

The <notificationTargetSelfReference> resource is a virtual resource, which does not have a representation and it is the child resource of a <subscription> resource. Whenever a Delete Request is sent to the <notificationTargetSelfReference > resource from a Notification Target which wants to remove itself from the Notification Target list (i.e. notificationURI) later, the Notifier shall act according to the action attribute defined in the <notificationTargetPolicy> resource which is linked from the <notificationTargetMgmtPolicyRef> resource defined for the specific notificationURI . If no specific policy is defined for the notification URI then the default policy shall apply.

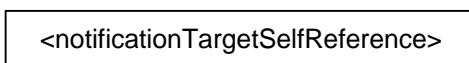

Figure 9.6.34-1: Structure of <notificationTargetSelfReference> resource

9.6.35 Resource Type *flexContainer*

The *<flexContainer>* resource type is a customizable container for data instances. It is a template for the definition of flexible specializations of data containers. Like a *<container>* resource, specializations of this *<flexContainer>* resource type are used to share information with other entities and potentially to track the data. While the *<container>* resources includes data to be made accessible to oneM2M entities inside *<contentInstance>* children, a specialization of the *<flexContainer>* resource includes associated content directly inside the *<flexContainer>* by means of one or more *[customAttribute]* attribute(s). The attribute name and attribute data type of *[customAttribute]* attributes are defined explicitly for each specialization of *<flexContainer>*, i.e. the specific set of attribute name and type are defined in a corresponding XSD-file.

Example usage of *<flexContainer>*: As a specialization of *<flexContainer>* that includes two *[customAttribute]* attributes, named "temperature"(xs:float type) and "humidity"(xs:positiveInteger type) can be specified in some TS. The actual data types of *[customAttribute]* will be described both in the specification document or XSD file which are referred by the value of *containerDefinition* attribute.

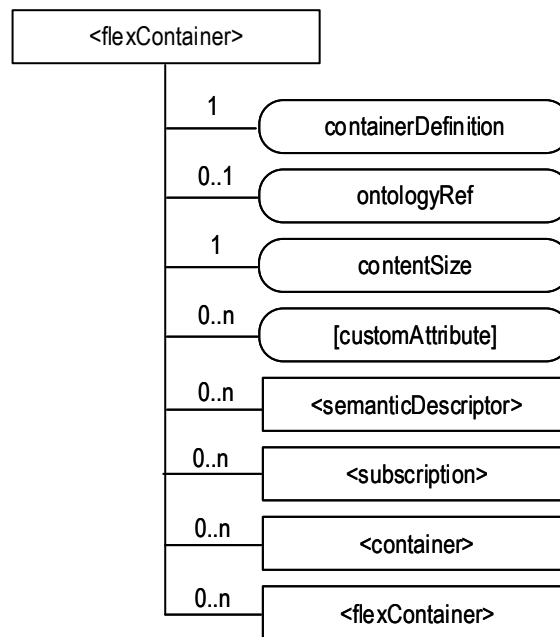

Figure 9.6.35-1: Structure of *<flexContainer>* resource

The *<flexContainer>* resource shall contain the child resource specified in table 9.6.35-1.

Table 9.6.35-1: Child resources of *<flexContainer>* resource

Child Resources of <i><flexContainer></i>	Child Resource Type	Multiplicity	Description	<i><flexContainerAnnc></i> Child Resource Type
[variable]	<i><semanticDescriptor></i>	0..n	See clause 9.6.30	<i><semanticDescriptor></i> , <i><semanticDescriptorAnnc></i>
[variable]	<i><subscription></i>	0..n	See clause 9.6.8	<i><subscription></i>
[variable]	<i><container></i>	0..n	See clause 9.6.6	<i><container></i> <i><containerAnnc></i>
[variable]	<i><flexContainer></i>	0..n	<i><flexContainer></i> resource can include any of its specializations as child resource	<i><flexContainer></i> <i><flexContainerAnnc></i>

The *<flexContainer>* resource shall contain the attributes specified in table 9.6.35-2.

Table 9.6.35-2: Attributes of *<flexContainer>* resource

Attributes of <i><flexContainer></i>	Multiplicity	RW/RO/WO	Description	<i><flexContainer Annc></i> Attributes
<i>resourceType</i>	1	RO	See clause 9.6.1.3.	NA
<i>resourceID</i>	1	RO	See clause 9.6.1.3.	NA
<i>resourceName</i>	1	WO	See clause 9.6.1.3.	NA
<i>parentID</i>	1	RO	See clause 9.6.1.3.	NA
<i>expirationTime</i>	0..1 (note)	RW	See clause 9.6.1.3.	MA
<i>accessControlPolicyIDs</i>	0..1 (L)	RW	See clause 9.6.1.3.	MA
<i>labels</i>	0..1 (L)	RW	See clause 9.6.1.3.	MA
<i>creationTime</i>	0..1 (note)	RO	See clause 9.6.1.3.	NA
<i>lastModifiedTime</i>	0..1 (note)	RO	See clause 9.6.1.3.	NA
<i>stateTag</i>	1	RO	See clause 9.6.1.3. This <i>stateTag</i> attribute value shall be incremented when a <i><container></i> or [<i>flexContainer</i>] child resource is created or deleted. This works same as the <i>stateTag</i> attribute update on a <i><container></i> resource at a <i><contentInstance></i> resource creation or deletion.	OA
<i>announceTo</i>	0..1 (L)	RW	See clause 9.6.1.3.	NA
<i>announcedAttribute</i>	0..1 (L)	RW	See clause 9.6.1.3.	NA
<i>dynamicAuthorizationConsultationIDs</i>	0..1 (L)	RW	See clause 9.6.1.3.	OA
<i>creator</i>	0..1	RO	See clause 9.6.1.3.	NA
<i>containerDefinition</i>	1	WO	This contains an identifier reference (URI) to the <i><flexContainer></i> schema definition which shall be used by the CSE to validate the syntax of the <i><flexContainer></i> resource. This URI may refer to one of the oneM2M <i><flexContainer></i> definitions specified in the following documents: <ul style="list-style-type: none"> • Generic Interworking [6] • AllJoyn Interworking [7]; • Home Domain Information Model [8] A list of oneM2M <i><flexContainer></i> definitions is also provided in clause 9.6.1.2.2, in oneM2M TS-0004 [3]. Other URI for other <i><flexContainer></i> definitions may be specified.	MA
<i>ontologyRef</i>	0..1	RW	A reference (URI) of the ontology used to represent the information that is stored in the present <i><flexContainer></i> resource.	OA
<i>contentSize</i>	1	RO	Sum of the size in bytes of all of the custom attributes.	OA
[<i>customAttribute</i>]	0..n	RW	Specialization-specific attribute(s). Name and data type defined in each specialization of <i><flexContainer></i> resource.	OA
NOTE: When an instance of <i><flexContainer></i> is a child of a <i><flexContainer></i> resource, these attributes can be optional. Their presence is determined by the respective definition referred to by the <i>containerDefinition</i> attribute.				

9.6.36 Resource Type *timeSeries*

The *<timeSeries>* resource represents a container for Time Series Data instances. It is used to share information with other entities and potentially to track, detect and report the missing data in Time Series. A *<timeSeries>* resource has no associated content. It has only attributes and child resources.

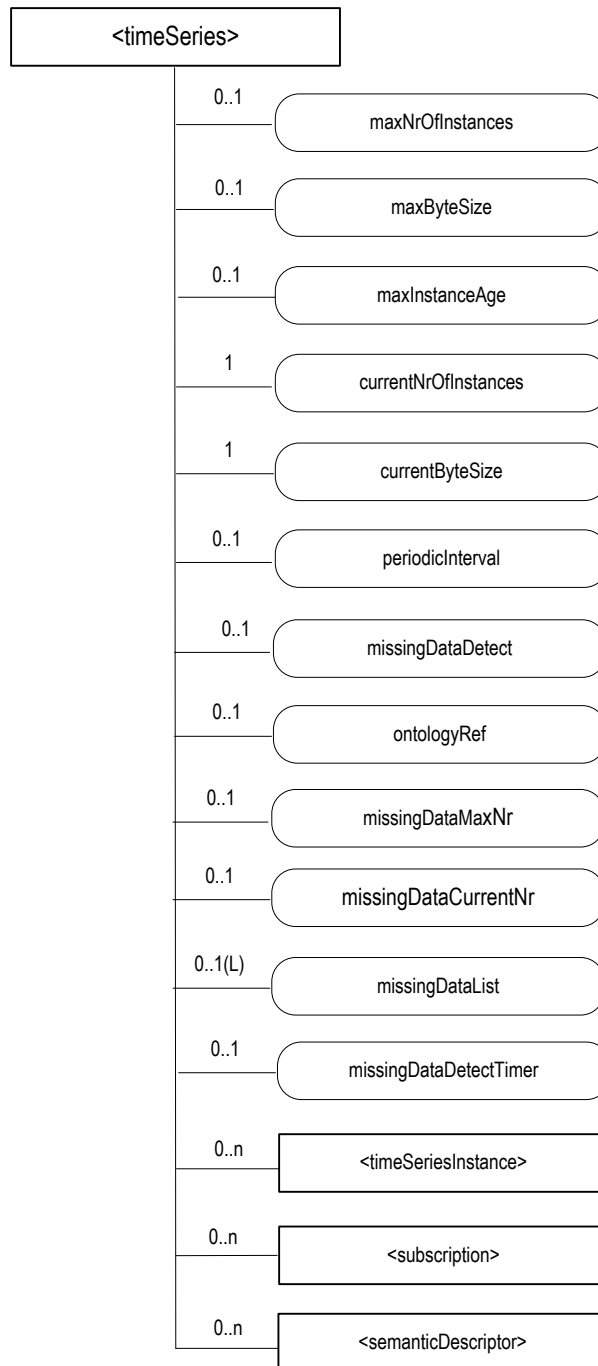

Figure 9.6.36-1: Structure of *<timeSeries>* resource

Table 9.6.36-1: Child resources of <timeSeries> resource

Child Resources of <timeSeries>	Child Resource Type	Multiplicity	Description	<timeSeriesAnnc> Child Resource Types
[variable]	<semanticDescriptor>	0..n	See clause 9.6.30	<semanticDescriptor>, <semanticDescriptorAnnc>
[variable]	<timeSeriesInstance>	0..n	See clause 9.6.37	<timeSeriesInstance>, <timeSeriesInstanceAnnc>
[variable]	<subscription>	0..n	See clause 9.6.8	<subscription>

The <timeSeries> resource shall contain the attributes specified in table 9.6.36-2.

Table 9.6.36-2: Attributes of <timeSeries> resource

Attributes of <timeSeries>	Multiplicity	RW/RO/WO	Description	<timeSeriesAnnc> Attributes
resourceType	1	RO	See clause 9.6.1.3.	NA
resourceID	1	RO	See clause 9.6.1.3.	NA
resourceName	1	WO	See clause 9.6.1.3.	NA
parentID	1	RO	See clause 9.6.1.3.	NA
expirationTime	1	RW	See clause 9.6.1.3.	MA
accessControlPolicyIDs	0..1 (L)	RW	See clause 9.6.1.3. If no accessControlPolicyIDs value is configured, the accessControlPolicyIDs of the parent resource shall be applied for privilege checking.	MA
labels	0..1 (L)	RW	See clause 9.6.1.3.	MA
creationTime	1	RO	See clause 9.6.1.3.	NA
lastModifiedTime	1	RO	See clause 9.6.1.3.	NA
stateTag	1	RO	See clause 9.6.1.3.	OA
announceTo	0..1 (L)	RW	See clause 9.6.1.3.	NA
announcedAttribute	0..1 (L)	RW	See clause 9.6.1.3.	NA
dynamicAuthorizationConsultationIDs	0..1 (L)	RW	See clause 9.6.1.3.	OA
creator	1	RO	See clause 9.6.1.3.	NA
maxNrOfInstances	0..1	RW	Maximum number of direct child <timeSeriesInstance> resources in the <timeSeries> resource.	OA
maxByteSize	0..1	RW	Maximum size in bytes of data that is allocated for the <timeSeriesInstance> resource for all direct child <timeSeriesInstance> resources.	OA
maxInstanceAge	0..1	RW	Maximum age of a direct child <timeSeriesInstance> resource in the <timeSeries> resource. The value is expressed in seconds.	OA
currentNrOfInstances	1	RO	Current number of direct child <timeSeriesInstance> resource in the <timeSeries> resource. It is limited by the maxNrOfInstances. The currentNrOfInstances attribute of the <timeSeries> resource shall be updated on successful creation or deletion of direct child <timeSeriesInstance> resource of <timeSeries> resource.	OA
currentByteSize	1	RO	Current size in bytes of data stored in all direct child <timeSeriesInstance> resources of a <timeSeries> resource. It is limited by the maxByteSize. The currentByteSize attribute of the <timeSeries> resource shall be updated on successful creation or deletion of direct child <timeSeriesInstance> resource of <timeSeries> resource.	OA

Attributes of <timeSeries>	Multiplicity	RW/RO/WO	Description	<timeSeriesAnc> Attributes
<i>periodicInterval</i>	0..1	WO	If the Time Series Data is periodic, this attribute shall contain the expected amount of time between two instances of Time Series Data.	OA
<i>missingDataDetect</i>	0..1	WO	Indicates whether the Receiver shall detect the missing Time Series Data if it is periodic.	NA
<i>ontologyRef</i>	0..1	RW	A reference (URI) of the ontology used to represent the information that is stored in the child <timeSeriesInstance> resources of the present <timeSeriesData> resource (see note).	OA
<i>missingDataMaxNr</i>	0..1	RW	Maximum number of entries in the <i>missingDataList</i> if the <i>periodicInterval</i> is set and the <i>missingDataDetect</i> is TRUE.	OA
<i>missingDataList</i>	0..1(L)	RO	The list of the <i>dataGenerationTime</i> value representing the missing Time Series Data in descending order by time if the <i>periodicInterval</i> is set and the <i>missingDataDetect</i> is TRUE.	OA
<i>missingDataCurrentNr</i>	0..1	RO	Current number of the missing Time Series Data in the <i>missingDataList</i> .	OA
<i>missingDataDetectTimer</i>	0..1	RW	The <i>missingDataDetectTimer</i> after which a missing Time Series Data shall be considered lost by the hosting CSE. Note that the setting of this value may not apply in certain transports such as TCP, and as such the hosting CSE may reject proposed values or suggest different values.	OA

NOTE: The access to this URI is out of scope of oneM2M.

9.6.37 Resource Type *timeSeriesInstance*

The <timeSeriesInstance> resource represents a data instance in the <timeSeries> resource. The <timeSeriesInstance> resource shall not be modified once created. An AE shall be able to delete a <timeSeriesInstance> resource explicitly or it may be deleted by the platform based on policies. If the platform has policies for <timeSeriesInstance> retention, these shall be represented by the attributes *maxByteSize*, *maxNrOfInstances* and/or *maxInstanceAge* attributes in the <timeSeries> resource. If multiple policies are in effect, the strictest policy shall apply. The <timeSeriesInstance> resource inherits the same access control policies of the parent <timeSeries> resource, and does not have its own *accessControlPolicyIDs* attribute.

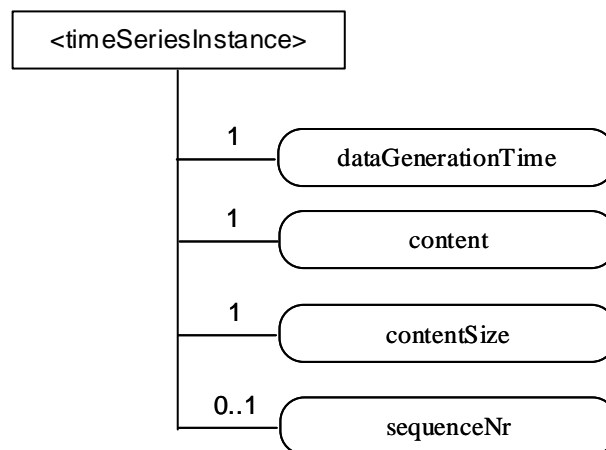

Figure 9.6.37-1: Structure of <timeSeriesInstance> resource

The `<timeSeriesInstance>` resource shall contain the attributes specified in table 9.6.37-1.

Table 9.6.37-1: Attributes of `<timeSeriesInstance>` resource

Attributes of <code><timeSeriesInstance></code>	Multiplicity	RW/RO/WO	Description	<code><timeSeriesInstanceAnnnc></code> Attributes
<code>resourceType</code>	1	RO	See clause 9.6.1.3.	NA
<code>resourceID</code>	1	RO	See clause 9.6.1.3.	NA
<code>resourceName</code>	1	WO	See clause 9.6.1.3.	NA
<code>parentID</code>	1	RO	See clause 9.6.1.3.	NA
<code>labels</code>	0..1 (L)	WO	See clause 9.6.1.3.	MA
<code>creationTime</code>	1	RO	See clause 9.6.1.3.	NA
<code>expirationTime</code>	1	WO	See clause 9.6.1.3.	NA
<code>announceTo</code>	0..1 (L)	RW	See clause 9.6.1.3.	NA
<code>announcedAttribute</code>	0..1 (L)	RW	See clause 9.6.1.3.	NA
<code>lastModifiedTime</code>	1	RO	See clause 9.6.1.3.	NA
<code>dataGenerationTime</code>	1	WO	This attribute contains the time when the data was generated by the AE/CSE.	OA
<code>content</code>	1	WO	This attribute contains the data generated by the AE/CSE.	OA
<code>contentSize</code>	1	RO	Size in bytes of the <code>content</code> attribute.	OA
<code>sequenceNr</code>	0..1	WO	This attribute contains the data sequence number generated by the AE/CSE.	OA

9.6.38 Resource Type `role`

The `<role>` resource represents a role that is assigned to an AE or CSE.

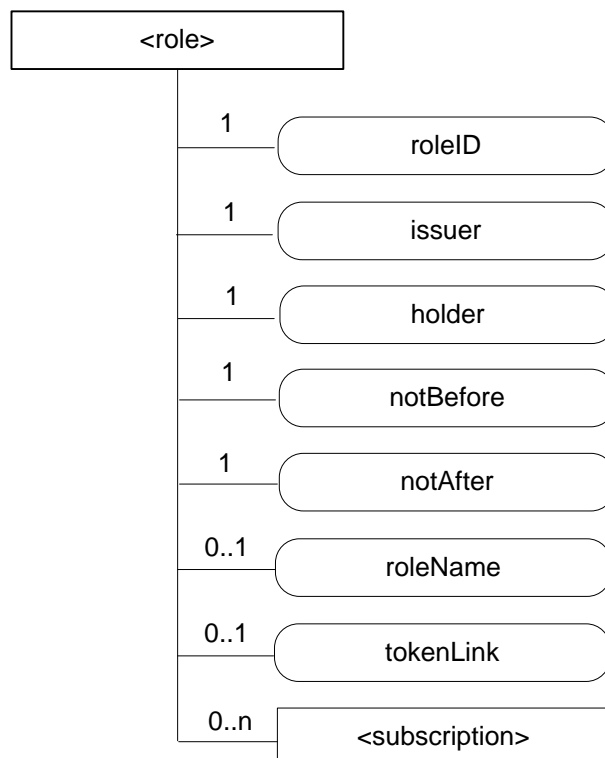

Figure 9.6.38-1: Structure of `<role>` resource

The <role> resource shall contain the child resources specified in table 9.6.38-1.

Table 9.6.38-1: Child resources of <role> resource

Child Resources of <role>	Child Resource Type	Multiplicity	Description
[variable]	<subscription>	0..n	See clause 9.6.8

The <role> resource shall contain the attributes specified in table 9.6.38-2.

Table 9.6.38-2: Attributes of <role> resource

Attributes of <role>	Multiplicity	RW/RO/WO	Description
resourceType	1	RO	See clause 9.6.1.3.
resourceID	1	RO	See clause 9.6.1.3.
resourceName	1	WO	See clause 9.6.1.3.
parentID	1	RO	See clause 9.6.1.3.
expirationTime	1	RW	See clause 9.6.1.3.
accessControlPolicyIDs	0..1 (L)	RW	See clause 9.6.1.3.
creationTime	1	RO	See clause 9.6.1.3.
labels	0..1 (L)	RW	See clause 9.6.1.3.
lastModifiedTime	1	RO	See clause 9.6.1.3.
dynamicAuthorizationConsultationIDs	0..1 (L)	RW	See clause 9.6.1.3.
roleID	1	WO	The identifier of the role.
issuer	1	WO	The identifier of the entity that is responsible for assigning the role to the AE or CSE.
holder	1	WO	The identifier of the AE or CSE that the role is assigned
notBefore	1	WO	Start time of the role can be used for access control.
notAfter	1	WO	End time of the role can be used for access control.
roleName	0..1	WO	Human readable name of the <role>.
tokenLink	0..1	RW	This attribute contains a reference to a token in which this role assignment is described.

9.6.39 Resource Type *token*

The <token> resource is used for storing a token that is issued to an AE or CSE. Details of the token may also be stored here in plaintext.

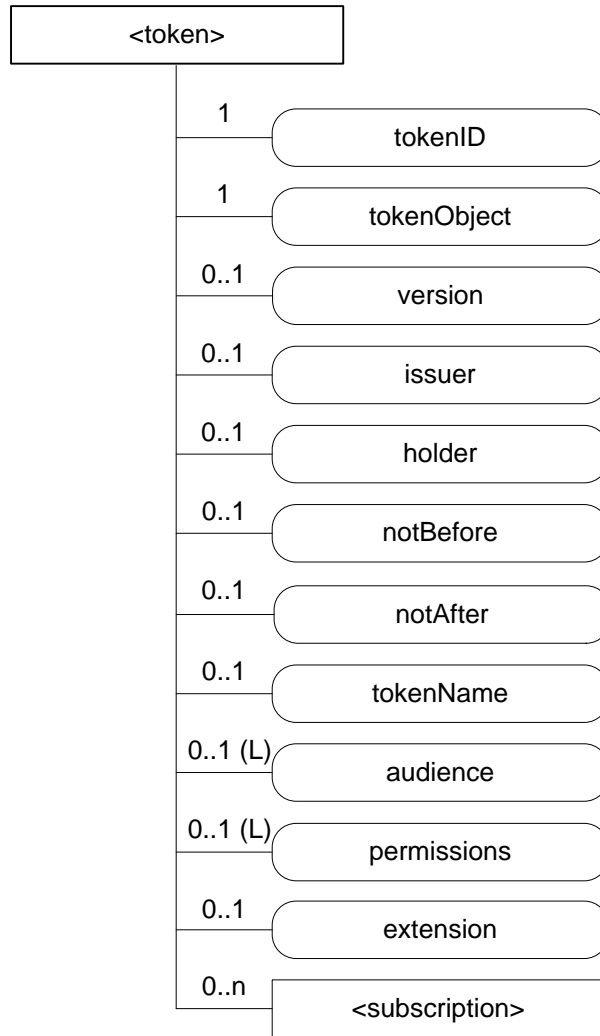

Figure 9.6.39-1: Structure of <token> resource

The <token> resource shall contain the child resources specified in table 9.6.39-1.

Table 9.6.39-1: Child resources of <token> resource

Child Resources of <token>	Child Resource Type	Multiplicity	Description
[variable]	<subscription>	0..n	See clause 9.6.8

The <token> resource shall contain the attributes specified in table 9.6.39-2.

Table 9.6.39-2: Attributes of <token> resource

Attributes of <token>	Multiplicity	RW/ RO/ WO	Description
resourceType	1	RO	See clause 9.6.1.3.
resourceID	1	RO	See clause 9.6.1.3.
resourceName	1	WO	See clause 9.6.1.3.
parentID	1	RO	See clause 9.6.1.3.
expirationTime	1	RW	See clause 9.6.1.3.
accessControlPolicyIDs	0..1 (L)	RW	See clause 9.6.1.3.
creationTime	1	RO	See clause 9.6.1.3.
labels	0..1 (L)	RW	See clause 9.6.1.3.
lastModifiedTime	1	RO	See clause 9.6.1.3.
dynamicAuthorizationConsultationIDs	0..1 (L)	RW	See clause 9.6.1.3.
tokenID	1	WO	The identifier of the token.
tokenObject	1	WO	Used to store the token. See clause 7.3.2.4 oneM2M TS-0003 [2] for further details of a token.
version	0..1	WO	Version of the token.
issuer	0..1	WO	The identifier of the entity that is responsible for issuing the token to the AE or CSE.
audience	0..1 (L)	WO	List of identifiers of the CSEs expected to accept the token.
holder	0..1	WO	The identifier of the AE or CSE to which the token is issued.
notBefore	0..1	WO	Start time of the token can be used for access control.
notAfter	0..1	WO	End time of the token can be used for access control.
tokenName	0..1	WO	Human readable name of the <token>..
permissions	0..1 (L)	WO	List of token permissions associated with the token. The structure of token permission is specified in the table 9.6.39-3.
extension	0..1	WO	Extension information held by the token, e.g. application-specific information.

The structure of token permission is specified in the table 9.6.39-3.

Table 9.6.39-3: Structure of token permission

Element	Multiplicity	Description	Note
resourceIDs	0..1	The resources to which this permission applies. If the privileges element is present, then this element shall be present.	
privileges	0..1	A set of access control rules applicable to the identified resources (for the identified holder).	At least one of these shall be present.
roleIDs	0..1	A set of role IDs applicable to the identified resources (for the identified holder).	

9.6.40 Resource Type *dynamicAuthorizationConsultation*

The <dynamicAuthorizationConsultation> resource shall be used by a CSE to perform consultation-based dynamic access control to resources as specified in the present document and in oneM2M TS-0003 [2].

The <dynamicAuthorizationConsultation> resource is comprised of configuration information that a resource Hosting CSE may use to determine whether or not to initiate a consultation-based dynamic authorization request.

For a resource that is not of <dynamicAuthorizationConsultation> resource type, the common attribute *dynamicAuthorizationConsultationIDs* for such resources (defined in table 9.6.1.3.2-1) may contain a list of identifiers which link that resource to <dynamicAuthorizationConsultation> resources.

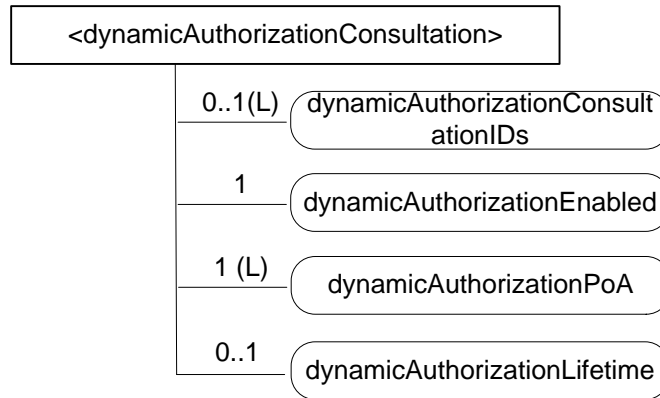

Figure 9.6.40-1: Structure of <dynamicAuthorizationConsultation> resource

The <dynamicAuthorizationConsultation> resource shall contain the attributes specified in table 9.6.40-1.

Table 9.6.40-1: Attributes of <dynamicAuthorizationConsultation> resource

Attributes of <dynamicAuthorizationConsultation>	Multiplicity	RW/RO/WO	Description
resourceType	1	RO	See clause 9.6.1.3.
resourceID	1	RO	See clause 9.6.1.3.
resourceName	1	WO	See clause 9.6.1.3.
parentID	1	RO	See clause 9.6.1.3.
expirationTime	1	RW	See clause 9.6.1.3.
creationTime	1	RO	See clause 9.6.1.3.
lastModifiedTime	1	RO	See clause 9.6.1.3.
labels	0..1 (L)	RW	See clause 9.6.1.3.
accessControlPolicyIDs	0..1 (L)	RW	See clause 9.6.1.3. If no accessControlPolicyIDs value is configured, the accessControlPolicyIDs of the parent resource shall be applied for privilege checking.
dynamicAuthorizationConsultationIDs	0..1 (L)	RW	See clause 9.6.1.3.
dynamicAuthorizationEnabled	1	RW	Controls whether consultation-based dynamic authorization is enabled or disabled. If disabled, Hosting CSE shall NOT initiate consultation-based dynamic authorization. Valid values are "TRUE" or "FALSE".
dynamicAuthorizationPoA	1 (L)	RW	A list of contact URIs of supporting consultation-based dynamic authorization.
dynamicAuthorizationLifetime	0..1	RW	The preferred lifetime of dynamic access control privileges that CSE shall specify as a parameter when issuing a consultation-based dynamic authorization request.

9.6.41 Resource Type trafficPattern

The <trafficPattern> resource represents the communication pattern and the mobility pattern of a field domain node to be shared with other entities such as the underlying network entity (NSE) of the field domain node which may optimize the processing of the underlying network for the specific field domain node by using this information.

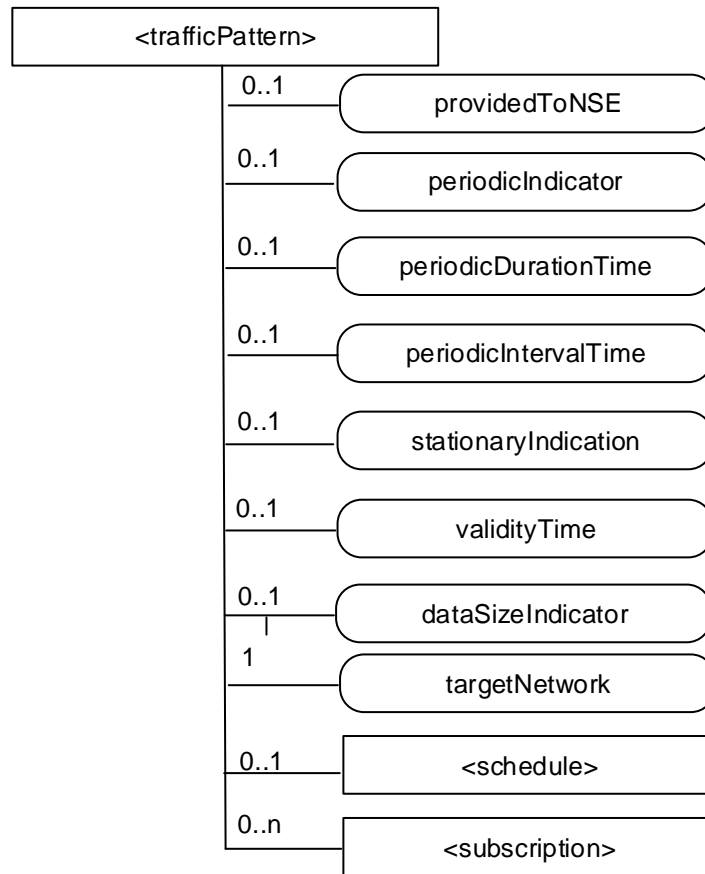

Figure 9.6.41-1: Structure of <trafficPattern> resource

The <trafficPattern> resource shall contain the child resources specified in table 9.6.41-1.

Table 9.6.41-1: Child resources of <trafficPattern> resource

Child Resources of <trafficPattern>	Child Resource Type	Multiplicity	Description	<trafficPatternAnnc> Child Resource Types
[variable]	<subscription>	0..n	See clause 9.6.8.	<subscription>
[variable]	<schedule>	0..1	See clause 9.6.9. It provides the mask for the day of week, the starting time and end time for communication. If it is not provided this shall be interpreted as 'anytime' at the NSE.	<scheduleAnnc>

The <trafficPattern> resource shall contain the attributes specified in table 9.6.41-2.

Table 9.6.41-2: Attributes of <trafficPattern> resource

Attributes of <trafficPattern>	Multiplicity	RW/RO/WO	Description	<trafficPatternAnnnc> Attributes
resourceType	1	RO	See clause 9.6.1.3.	NA
resourceID	1	RO	See clause 9.6.1.3.	NA
resourceName	1	WO	See clause 9.6.1.3.	NA
parentID	1	RO	See clause 9.6.1.3.	NA
creationTime	1	RO	See clause 9.6.1.3.	NA
lastModifiedTime	1	RO	See clause 9.6.1.3.	NA
expirationTime	1	RW	See clause 9.6.1.3.	MA
accessControlPolicyIDs	0..1 (L)	RW	See clause 9.6.1.3.	MA
labels	0..1 (L)	RW	See clause 9.6.1.3.	MA
dynamicAuthorizationConsultationIDs	0..1 (L)	RW	See clause 9.6.1.3.	
announceTo	0..1(L)	RW	See clause 9.6.1.3.	NA
announcedAttribute	0..1(L)	RW	See clause 9.6.1.3.	NA
providedToNSE	0..1	RO	It indicates as 'TRUE' or 'FALSE' whether the traffic pattern has been provided to a NSE	OA
periodicIndicator	0..1	RW	It indicates as 'Periodical' or 'On demand'.	OA
periodicDurationTime	0..1	RW	It provides the time in seconds of the duration of the periodic communication.	OA
periodicIntervalTime	0..1	RW	It provides the time in seconds of the interval for periodic communication.	OA
stationaryIndication	0..1	RW	It indicates as 'Stationary (Stopping)' or 'Mobile (Moving)'.	OA
dataSizeIndicator	0..1	RW	It indicates the expected data size for the pattern.	OA
validityTime	0..1	RW	It contains the point of time when the informed <trafficPattern> information to the NSE becoming invalid and shall be deleted at the NSE.	OA
targetNetwork	1	RW	<p>The <i>targetNetwork</i> attribute defines for which Underlying Networks this <trafficPattern> resource shall be applied.</p> <p>The <i>targetNetwork</i> attribute is a list of one or more strings identifying names of Underlying Networks or the string 'default' (see note).</p> <p>When a name of an Underlying Network appears in the <i>targetNetwork</i> attribute, this <trafficPattern> resource shall be applied for that specific Underlying Network</p> <p>Each Underlying Network name or the string 'default' shall appear at most once in the <i>targetNetwork</i> attribute</p> <p>This attribute is a specialization of [<i>objectAttribute</i>] attribute.</p>	OA
NOTE: A naming convention for Underlying Network names is not supported in this release of the specification.				

10 Information Flows

10.1 Basic Procedures

10.1.0 Overview

As a pre-condition to the execution of the following procedures, M2M operational security procedures as specified in clauses 11.3.1 through 11.3.3 shall have been performed. In case of failure, the error shall be reported as specified in oneM2M TS-0004 [3].

The procedures in the following clauses assume blocking requests as described in clause 8.2.2.

10.1.1 CREATE (C)

10.1.1.0 Introduction

The CREATE procedure shall be used by an Originator CSE or AE to create a resource on a Receiver CSE (also called the Hosting CSE). The description of CREATE procedure has been divided in two separate clauses, since there is a need to distinguish between Registration related Create and Non-Registration related Create procedures.

The Registration related Create procedure is applicable for the following resource types only:

- <AE>; and
- <remoteCSE>.

Whereas non-registration related Create procedure is applicable for all other resource types described in clause 9.6.

10.1.1.1 Non-registration related CREATE procedure

This procedure is valid for all resources which are not related to registration.

Originator requests to create a resource by using the CREATE method. See clause 8.1.2 for the parameters to be included in the Request message.

Hosting CSE If the request is allowed by the given privileges, the Receiver shall create the resource.

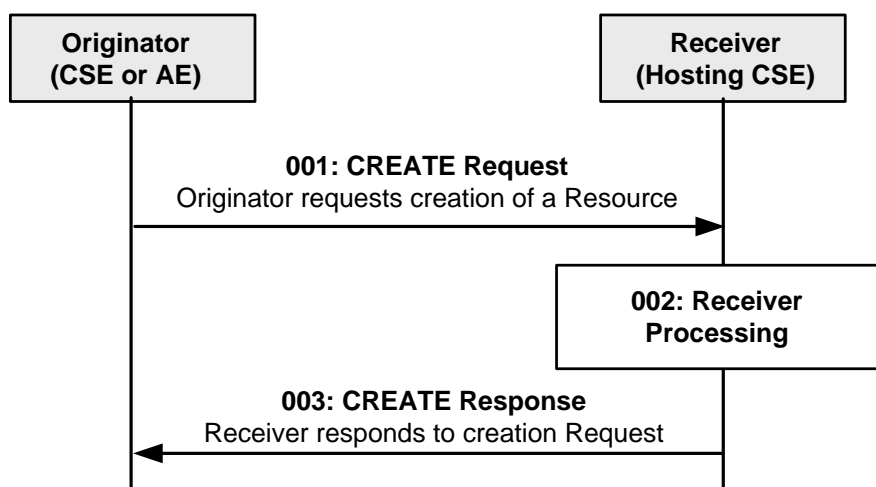

Figure 10.1.1.1-1: Procedure for CREATEing a Resource

Step 001: The Originator shall send mandatory parameters and may send optional parameters in Request message for CREATE operation as specified in clause 8.1.2.

Step 002: The Receiver shall:

- 1) Check if the Originator has the appropriate privileges for performing the request. Privileges of the targeted resource are linked by the *accessControlPolicyIDs* attribute. Different handlings for a target resource which does not have the *accessControlPolicyIDs* attribute by the resource type definition (e.g. *schedule* resource type) or a target resource which has the definition but the attribute has no value and so on are defined in the table 9.6.1.3.2-1 (common attributes description).
- 2) Verify that the name for the created resource as suggested by the *resourceName* attribute in **Content** parameter, if provided by the Originator in the CREATE Request message, does not already exist among child resources of the target resource. If no child within the targeted resource exists with the same *resourceName* as suggested by the Originator, use that name for the resource to be created. If a child uses the *resourceName* already, the Receiver shall reject the request and return an error to the Originator. If the name was not suggested by the Originator, assign a name generated by the Receiver to the resource to be created.

NOTE: The name of a resource in general is not the same as its Resource ID. While a name of a resource only needs to be unique among the children of the same parent resource, the Resource ID needs to be unique in context of the Hosting CSE. When the name of the resource to be created is assigned by the Receiver, it may choose to use a name that is identical to the Unstructured-CSE-relative-Resource ID.

- 3) Assign a Resource-ID (see *resourceID* attribute in common attribute table 9.6.1.3.2-1) to the resource to be created.
- 4) Assign values for mandatory RO mode attributes of the resource and override values provided for other mandatory attributes, where needed, and where allowed by the resource type definition and if not provided by the Originator itself.
- 5) the Receiver shall assign a value to the following common attributes specified in clause 9.6.1.3:
 - a) *parentID*;
 - b) *creationTime*;
 - c) *expirationTime*: if not provided by the Originator, the Receiver shall assign the maximum value possible (within the restriction of the Receiver policies). If the value provided by the Originator cannot be supported, due to either policy or subscription restrictions, the Receiver will assign a new value;
 - d) *lastModifiedTime*: which is equals to the *creationTime*;
 - e) Any other RO (Read Only) attributes within the restriction of the Receiver policies.
- 6) The Receiver shall check whether a *creator* attribute is included in the **Content** parameter of the request. If included, the *creator* attribute shall not have a value in the **Content** parameter of the request. If the *creator* attribute is included in the request and the *creator* attribute is supported for the type of resource being created, then the Receiver shall to include the *creator* attribute in the resource to be created. The Receiver shall assign a value equal to the value carried in the **From** request parameter. In the event that the originator provides a value for the *creator* attribute within the request, this request shall be deemed invalid.

On the other hand if the *creator* attribute is not included in the **Content** parameter of the request, then the Receiver shall not include the *creator* attribute in the resource to be created.
- 7) On successful validation of the Create Request, the Receiver shall create the requested resource.
- 8) The Receiver shall check if the created child resource leads to changes in its parent resource's attribute(s), if so the parent resource's attribute(s) shall be updated.

Step 003: The Receiver shall respond with mandatory parameters and may send optional parameters in Response message for CREATE operation as specified in clause 8.1.3.

General Exceptions:

- 1) The Originator does not have the privileges to create a resource on the Receiver. The Receiver responds with an error.
- 2) The resource with the specified name (if provided) already exists at the Receiver. The Receiver responds with an error.

- 3) The provided information in *Content* is not accepted by the Receiver (e.g. missing mandatory parameter). The Receiver responds with an error.

10.1.1.2 Registration related CREATE procedure

10.1.1.2.0 Overview

This clause describes the CREATE procedure for <remoteCSE> and <AE> resource type.

10.1.1.2.1 CSE Registration procedure

The procedure for CSE Registration follows the procedure described in clause 10.1.1.1, but with some deviations. Below is the detailed description on how to perform the CSE Registration and which part of the procedure deviates from the one described in clause 10.1.1.1.

The Registration procedure requires the creation of two resources (a <remoteCSE> on the Receiver CSE and a <remoteCSE> on the Originator CSE) rather than one resource. The Registration procedure is always initiated by a CSE in the field domain except in the inter-domain case described in clause 6.5.

Originator: The Originator shall be the registering CSE.

Receiver: The Receiver shall create the <remoteCSE> resource.

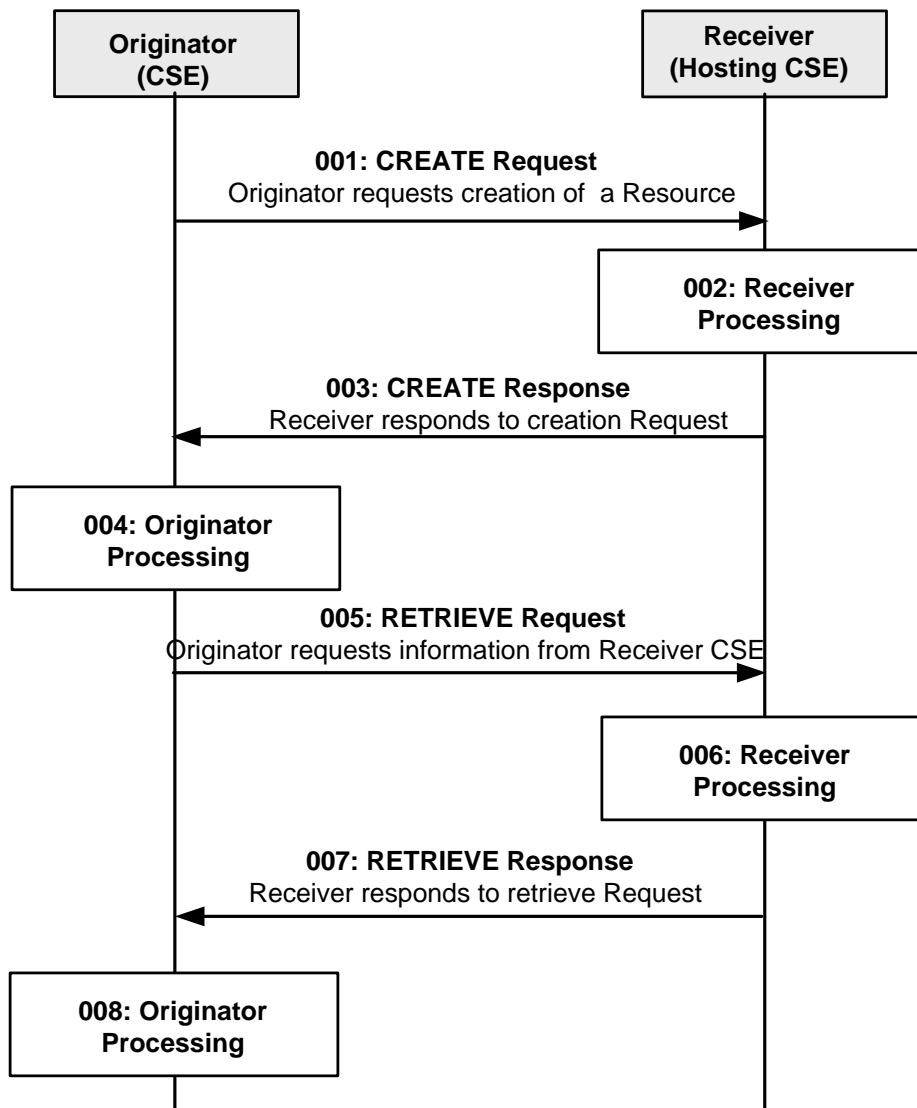

Figure 10.1.1.2.1-1: Procedure for CREATEing a <remoteCSE> Resource

All the parameters of the request and steps that are not indicated do not deviate from clause 10.1.1.1.

Step 001: The Originator shall send mandatory parameters and may send optional parameters in Request message for CREATE operation as specified in clause 8.1.2.

Step 002: The Receiver shall:

- 1) The registrar CSE shall allow unknown remote CSE to attempt to 'CREATE' when it was authenticated by credential provided by the entity. See oneM2M TS-0003 [2] further detail about authentication for the CSE.
- 2) Perform sub-steps: 2)-8), from step 002 from clause 10.1.1.1 are applicable.

NOTE: Optionally, if the M2M Service Provider supports inter-domain communication, the Receiver could perform this step if the attribute *CSEBase* (part of the *Content* parameter of the request) contains the public domain of the CSE. The Receiver could construct the domain as described in clauses 6.4 and 6.5. The Receiver could add an AAA or AAAA record in DNS with the public domain name of the Originator CSE and the IP address of the IN-CSE associated with the Originator.

Step 003: See clause 10.1.1.1.

Step 004: The Originator, upon receipt of the successful CREATE response message, shall create a <remoteCSE> resource locally under its <CSEBase> resource. This resource is representing the Receiver CSE. The Originator shall provide the appropriate values to all mandatory parameters as described in clause 9.6.4.

Step 005: The Originator may issue a RETRIEVE Request towards the Receiver (same *To* as for the CREATE request message) to obtain the optional attributes of the <remoteCSE> resource created at the Originator in step 004 (e.g. *labels*, *accessControlPolicyIDs* attributes). The RETRIEVE procedure is described in clause 10.1.2.

See clauses 8.1.2 for the information to be included in the Request message.

Step 006: The Receiver verifies that the Originator has the appropriate described in clause 10.1.2.

See clauses 8.1.3 for the information to be included in the Response message.

Step 007: The Originator shall update the created <remoteCSE> resource for the Receiver with the information obtained in step 007.

General Exceptions:

All exceptions from clause 10.1.1.1 are applicable; in addition the following exception may occur:

- 1) The Originator does not have the privileges to retrieve the attributes of the Receiver CSE. The Receiver responds with an error.

10.1.1.2.2 Application Entity Registration procedure

The procedure for AE registration follows the message flow description depicted in figure 10.1.1.2.2-1. It defines in which cases additional procedures need to be initiated by the Registrar CSE for creating or updating of <AEAnnnc> resources hosted on the M2M SP's IN-CSE in case an AE-ID-Stem starting with an 'S' character shall be used, see table 7.2-1 for the definition of AE-ID-Stem. The above additional procedures i.e. steps related to announcement shall not be required when Registrar CSE is the IN-CSE.

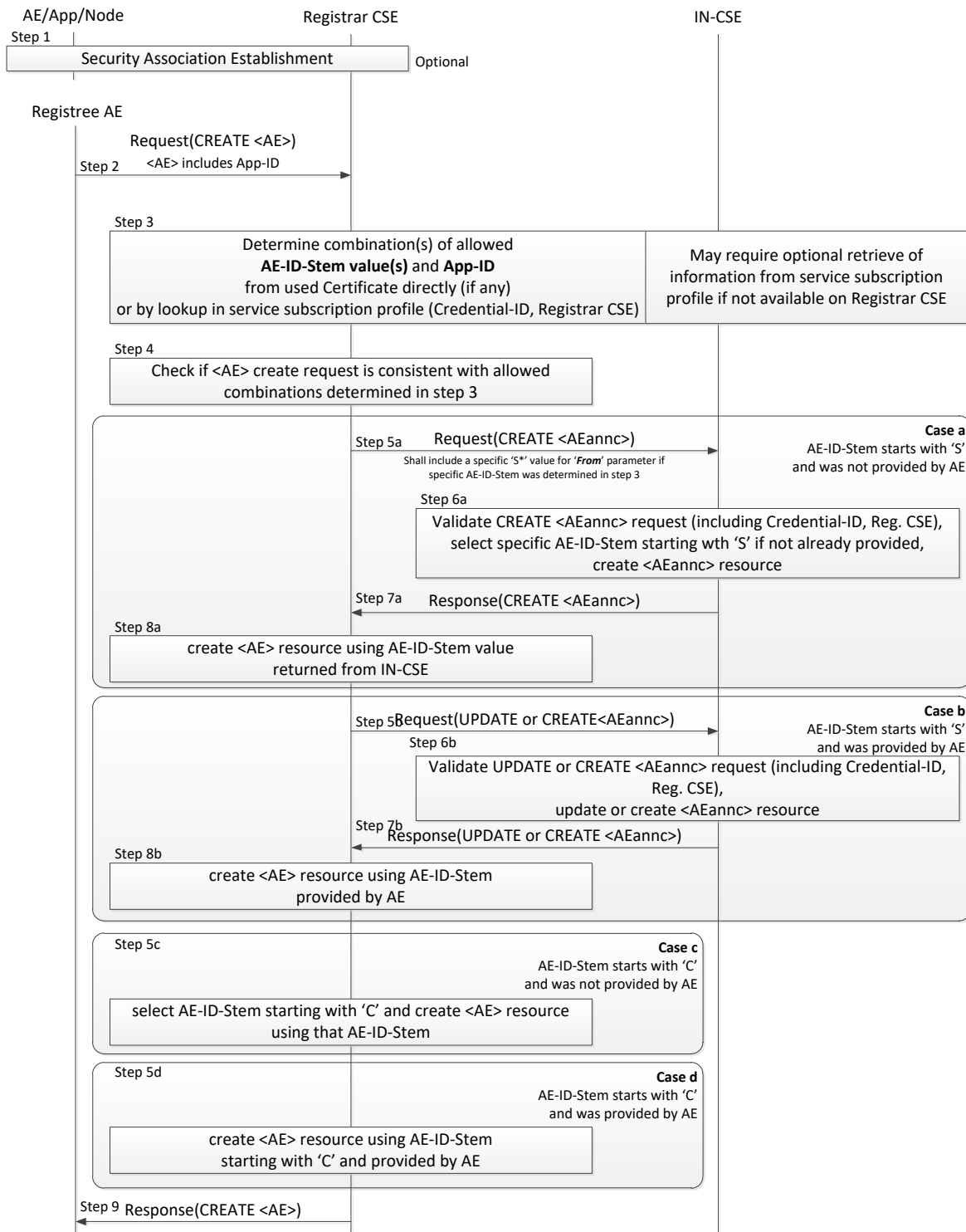

Figure 10.1.1.2.2-1: Procedure for Creating an <AE> Resource

Originator: The Originator shall be the Registrant AE.

Receiver: The Receiver shall allow the creation of the <AE> resource according to the access control policy and information in the applicable m2m service subscription profile. To validate the m2m service subscription profile, the Receiver shall check the corresponding <serviceSubscribedNode> resource, by matching the CSE-ID in the m2m service subscription profile against the Receiver owned CSE-ID. Subsequently the Receiver shall check whether the Registrant AE is included in the linked (i.e. ruleLinks attribute) <serviceSubscribedAppRules> resource(s).

Step 001: Optional: In case the Registree AE intends to use a Security Association to perform the registration, a Security Association Establishment procedure (see clause 11.2.2) shall get carried out first. In some cases (e.g. registration of AE internal to an MN or ASN), this may not be required depending on deployment choices of the M2M SP. Therefore, this step is optional. This optional Security Association can be established between the following entities:

- The Registree AE and the Registrar CSE - in which case the specific AE that is subsequently sending the request to get registered shall be authenticated.
- The Node on which the Registree AE is hosted and the Registrar CSE - in which case only the Node from which the registration request is received at the Registrar CSE shall be authenticated. In this case one or more AEs hosted on the authenticated node may communicate over either a single Security Association or over individual Security Associations.

NOTE: The Node authentication should be used only when the M2M Service Provider trusts the AE (on the Node) to provide the correct AE-ID and App-ID. The present document does not provide mechanisms by which the M2M Service Provider can obtain assurance about the trustworthiness of the AE when using Node authentication. For example, such a mechanism (by which the M2M Service Provider can obtain assurance about the trustworthiness of the AE) could be provided by executing the M2M Application on a secure environment.

The identifier of the security credentials used for establishing the Security Association in this step shall be termed 'Credential-ID' for the remainder of this procedure description. If no Security Association has been performed the Credential-ID shall be assumed to have the value 'None'.

Step 002: The Originator shall send the information defined in clause 10.1.1.1 for the registration CREATE procedure with the following specific information in the CREATE Request message:

- **From:** AE-ID-Stem or Not Present:
 - i. In case the Registree AE has already registered successfully before, then deregistered and intends to register again with the same AE-ID-Stem value as before, the Registree AE shall include that AE-ID-Stem value into the **From** parameter.
 - ii. In case the Registree AE intends to initiate a fresh registration with a pre-provisioned AE-ID-Stem value, the Registree AE shall include that pre-provisioned AE-ID-Stem value into the **From** parameter.
 - iii. In case the Registree AE has not registered successfully before and intends to get an M2M-SP-assigned AE-ID-Stem starting with an 'S' character assigned to itself but it does not have any specific value to suggest, it shall set the **From** parameter to the character 'S'.
 - iv. In case the Registree AE has not registered successfully before and intends to get a Registrar CSE-assigned AE-ID-Stem starting with an 'C' character assigned to itself but it does not have any specific value to suggest, it shall set the **From** parameter to the character 'C'.
 - v. In case the Registree AE intends to initiate a fresh registration and has no preference for the AE-ID-Stem value, the **From** parameter shall not be sent.

The CSE shall allow unknown AEs to attempt the 'CREATE' before they are granted this permission. See oneM2M TS-0003[2] for further details about authentication for the AE.

Step 003: The Receiver shall determine whether the request to register the Registree AE meets any of the following conditions:

- In case the Security Association Establishment in Step 001 was performed using security credentials in form of a Certificate that included an App-ID and an AE-ID-Stem attribute, check if they match with the App-ID attribute in the **Content** parameter of the request and the AE-ID-Stem in the **From** parameter of the request.

- Check if the applicable service subscription profile lists a combination of (allowed AE-ID-Stem value and allowed App-ID value) for the Credential-ID and the Registrar CSE-ID (see clause 11.2.2) that match with the App-ID attribute in the **Content** parameter of the request and the AE-ID-Stem in the **From** parameter of the request. If the information needed to perform that checking is not available to the Registrar CSE locally, the Registrar CSE shall retrieve that information from the applicable service subscription profile(s) from the IN-CSE. If the **From** parameter was not set in the request and the allowed AE-ID-Stem includes a wild card ("*") in the applicable service subscription profile(s), the Registrar CSE shall assign the starting character ('S', 'C') in accordance with provisioned Service Provider policy. The applicable rules for this checking are contained in the <serviceSubscribedAppRule> resource(s) which are linked to by the *ruleLinks* attribute of the <m2mServiceSubscribedNode> resource(s) associated with the Registrar CSE. The <m2mServiceSubscribedNode> resource(s) associated with the Registrar CSE can be retrieved from the IN-CSE by applying the **Filter Criteria** parameter set to "CSE-ID={Registrar-CSE-ID}" where {Registrar-CSE-ID} needs to be substituted by the actual CSE-ID of the Registrar-CSE.

If none of the conditions are met, the registration is not allowed and the Receiver shall respond with an error.

Step 004: If the **From** parameter of the request provides a complete AE-ID-Stem value, , i.e. case i or ii of Step 002 applied, the Registrar CSE shall check whether an <AE> resource with an Unstructured-CSE-relative-Resource-ID identical to the AE-ID-Stem value provided in the **From** parameter of the request does already exist on the Registrar CSE. If so, there is still an active registration using the same AE-ID-Stem on the Registrar CSE and the Registrar CSE shall respond with an error. If not, the Registrar CSE shall perform action (3) in *Step 002* of clause 10.1.1.1.

If the **From** parameter of the request provides a complete AE-ID-Stem and starts with 'S', i.e. case i or ii of Step 002 applied and 'S' is the first character of the provided AE-ID-Stem, the procedure continues with case b) of the present step 004 below.

If **From** parameter of the request provides a complete AE-ID-Stem and starts with 'C', i.e. case i or ii of Step 002 applied and 'C' is the first character of the provided AE-ID-Stem, the procedure continues with case d) of the present step 004 below.

If the **From** parameter of the request is equal to the value 'S', i.e. case iii of Step 002 applied, the procedure continues with case a) of the present step 004 below.

If the **From** parameter of the request is equal to the value 'C', i.e. case iv of Step 002 applied, the procedure continues with case c) of the present step 004 below.

If the **From** parameter of the request is not sent, the Registrar CSE shall perform action (3) in *Step 002* of clause 10.1.1.1 to assign the resourceID with starting character ('S', 'C') in accordance with provisioned Service Provider policy and shall set the corresponding value in AE-ID-Stem. If the assigned value in AE-ID-Stem attribute starts with 'S', the procedure continues with case b) else the procedure continues with case d). **Case a) AE-ID-Stem starts with 'S' and AE does not include an AE-ID-Stem (initial registration):**

Condition: In **Step 003** it was determined that the AE-ID-Stem value to be used for the Registree AE starts with an 'S' character but no specific AE-ID-Stem was provided with the CREATE request of the Registree AE. This case applies when the Registree AE is supposed to use an M2M-SP-assigned AE-ID and wants to perform the initial registration:

- **Step 005a:** The Receiver shall send a CREATE request for an <AEAnnc> resource to the IN-CSE in order to create an <AEAnnc> resource on the IN-CSE that is associated with the Registree AE. The following information shall be sent with that CREATE request:
 - In case no specific AE-ID-Stem value to be used for the Registree AE was determined during **Step 003**, the value 'S' shall be used in what follows for the AE-ID-Stem. Otherwise use the value determined in **step 003**.
 - The **From** parameter of the CREATE request for the <AEAnnc> resource shall be set to the SP-relative-CSE-ID or Absolute-CSE-ID followed by '/S'.
 - The *link* attribute of the <AEAnnc> resource to be created shall be set to the SP-Relative-Resource-ID format of a - not yet existent - <AE> resource hosted on the Registrar CSE constructed with a Unstructured-CSE-relative-Resource-ID that is equal to the AE-ID-Stem value used for the Registree AE.
 - The App-ID attribute of the <AEAnnc> resource to be created shall be present and set to the App-ID attribute value of the Registree AE.

- The concatenation of the string 'Credential-ID:' and the actual Credential-ID of the Security Association used by the Registree AE - if any - shall be placed into the labels attribute of the <AEAnn< resource. If no Security Association was used by the Registree AE, a value of 'None' shall be used for Credential-ID.
- **Step 006a:** Upon reception of the CREATE <AEAnn< request, the IN-CSE shall validate the request and verify whether the provided values of the App-ID attribute and the AE-ID-Stem in the *From* parameter is allowed for the combination of Credential-ID included in the labels attribute and the CSE-ID of the Registrar CSE included in the link attribute, according to the applicable service subscription profile. If that verification is successful and no specific AE-ID-Stem is provided, i.e. if the *From* parameter contains only the character 'S', the IN-CSE shall select an AE-ID-Stem in line with the applicable service subscription profile.
- **Step 007a:** When the validation and verification in **Step 006a** completed successfully, the IN-CSE shall create <AEAnn< resource with an Unstructured-CSE-relative-Resource-ID equal to the value of the AE-ID-Stem, replace the AE-ID-Stem for the trailing 'S' character in the Unstructured-CSE-relative-Resource-ID present in the *link* attribute if the AE-ID-Stem was selected by the IN-CSE, and send a successful response to the Registrar CSE.
- **Step 008a:** Upon reception of a successful response from the IN-CSE, the Registrar CSE shall use the Unstructured-CSE-relative-Resource-ID that was used for the <AEAnn< resource on the IN-CSE also as the assigned Unstructured-CSE-relative-Resource-ID for the <AE> resource to be created on the Registrar CSE and continue with action (4) of **Step 002** of the non-registration related CREATE procedure in clause 10.1.1.1.

Case b) AE-ID-Stem starts with 'S' and AE includes an AE-ID-Stem (initial registration or re-registration):

Condition: In **Step 003** it was determined that the AE-ID-Stem value to be used for the Registree AE starts with an 'S' character and a specific AE-ID-Stem was provided with the CREATE request of the Registree AE. This case applies when the Registree AE is supposed to use an M2M-SP-assigned AE-ID and wants to perform initial registration or re-registration using its already assigned AE-ID-Stem:

- **Step 005b:** The receiver shall determine if an <AEAnn< resource already exists on the IN-CSE that is associated with the Registree AE. The Receiver shall send an UPDATE request for an <AEAnn< resource to the IN-CSE in order to update the already existing <AEAnn< resource on the IN-CSE that is associated with the Registree AE in case of re-registration or the Receiver shall send a CREATE request for an <AEAnn< resource to the IN-CSE in order to create an <AEAnn< resource on the IN-CSE that is associated with the Registree AE in case of initial registration. The following information shall be sent with that UPDATE or CREATE request:
 - The *To* parameter shall contain the SP-relative-Resource-ID format of the Resource ID for the <AEAnn< resource which shall be constructed from the CSE-ID of the IN-CSE and the AE-ID-Stem that the Registree AE provided.
 - *From* parameter of the CREATE or UPDATE request for the <AEAnn< resource shall be set to the SP-relative-CSE-ID or Absolute-CSE-ID followed by '/' and the AE-ID-Stem value.
 - The link attribute of the <AEAnn< resource shall be set (in case of initial registration) or updated (in case of re-registration) to the SP-Relative-Resource-ID format of a - not yet existent - <AE> resource hosted on the Registrar CSE constructed with an Unstructured-CSE-relative-Resource-ID that is equal to the AE-ID-Stem value used for the Registree AE.
 - The labels attribute of the <AEAnn< resource shall be set (in case of initial registration) or updated (in case of re-registration) to the concatenation of the string 'Credential-ID:' and the Credential-ID of the Security Association used by the Registree AE, replacing the existing entry starting with 'Credential-ID:' if present. If no Security Association was used by the Registree AE, a value of 'None' shall be used for Credential-ID.
- **Step 006b:** Upon reception of the CREATE or UPDATE <AEAnn< request, the IN-CSE shall validate the request and verify whether the values suggested to be set or to be updated for the Credential-ID included in the labels attribute - if any - and the CSE-ID of the Registrar CSE included in the *From* parameter still match with any of the allowed combinations of *App-ID* attribute and the AE-ID-Stem in the *link* attribute according to the applicable service subscription profile.
- **Step 007b:** When the validation and verification in **Step 006b** completed successfully, the IN-CSE shall create <AEAnn< resource with an Unstructured-CSE-relative-Resource-ID equal to the value of the provided AE-ID-Stem or update the <AEAnn< resource in line with the parameters provided in step 005b.

- **Step 008b:** Upon reception of a successful response from the IN-CSE, the Registrar CSE shall use the Unstructured-CSE-relative-Resource-ID equal to the AE-ID-Stem provided by the Registree AE for the <AE> resource to be created on the Registrar CSE and continue with action (4) of **Step 002** of the non-registration related CREATE procedure in clause 10.1.1.1.

Case c) AE-ID-Stem starts with 'C' and AE does not include an AE-ID-Stem (initial registration):

Condition: In **Step 003** it was determined that the AE-ID-Stem value to be used for the Registree AE starts with an 'C' character but no specific AE-ID-Stem was provided with the CREATE request of the Registree AE. This case applies when the Registree AE is not supposed to use an M2M-SP-assigned AE-ID and wants to perform the initial registration:

- **Step 005c:** The Registrar CSE shall select an AE-ID-Stem starting with a 'C' character and use it for the Unstructured-CSE-relative-Resource-ID for the <AE> resource to be created on the Registrar CSE and continue with action (4) of **Step 002** of the non-registration related CREATE procedure in clause 10.1.1.1.

Case d) AE-ID-Stem starts with 'C' and AE includes an AE-ID-Stem (initial registration or re-registration):

Condition: In **Step 003** it was determined that the AE-ID-Stem value to be used for the Registree AE starts with an 'C' character and a specific AE-ID-Stem was provided with the CREATE request of the Registree AE. This case applies when the Registree AE is not supposed to use an M2M-SP-assigned AE-ID and wants to perform initial registration or re-registration using its already assigned AE-ID-Stem:

- **Step 005d:** The Registrar CSE shall use the Unstructured-CSE-relative-Resource-ID equal to the AE-ID-Stem in the *From* parameter for the <AE> resource to be created on the Registrar CSE and continue with action (4) of **Step 002** of the non-registration related CREATE procedure in clause 10.1.1.1.

10.1.2 RETRIEVE (R)

The RETRIEVE operation shall be used for retrieving the information stored for any of the attributes for a resource at the Receiver CSE. The Originator CSE or AE may request to retrieve a specific attribute by including the name of such attribute in the *Content* parameter in the request message.

Originator: Requests retrieval of all attributes or a specific attributes of the target resource by using RETRIEVE Request. See clause 8.1.2 for the information to be included in the Request message. If only some specific attributes need to be retrieved, the name of such attributes shall be included in the *Content* parameter of the Request message.

Receiver: The Receiver performs local processing to verify the existence of requested resource and checks privileges for retrieving the information related to the resource. After successful verification, the Receiver shall return the requested information, otherwise an error indication shall be returned.

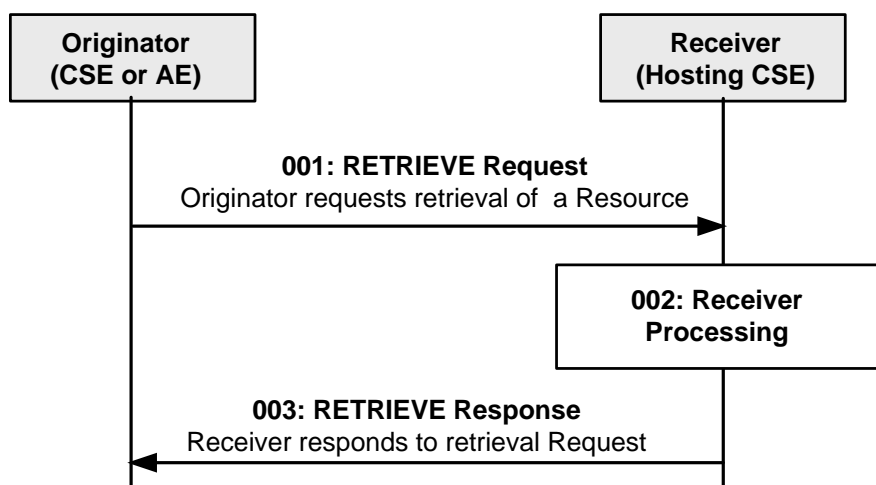

Figure 10.1.2-1: Procedure for RETRIEVING a Resource

Step 001: The Originator shall send mandatory parameters and may send optional parameters in Request message for RETRIEVE operation as specified in clause 8.1.2.

Step 002: The Receiver shall verify the existence (including *Filter Criteria* checking, if it is given) of the target resource or the attribute and check if the Originator has appropriate privileges to retrieve information stored in the resource/attribute. This privilege checking follows the rules defined in the table 9.6.1.3.2-1 (common attributes description).

Step 003: The Receiver shall respond with mandatory parameters and may send optional parameters in Response message for RETRIEVE operation as specified in clause 8.1.3.

General Exceptions:

- 1) The targeted resource/attribute in *To* parameter does not exist. The Receiver responds with an error.
- 2) The Originator does not have privileges to retrieve information stored in the resource on the Receiver. The Receiver responds with an error.

10.1.3 UPDATE (U)

The UPDATE operation shall be used for updating the information stored for any of the attributes at a target resource. Especially important is the *expirationTime*, since a failure in refreshing this attribute may result in the deletion of the resource. The Originator CSE or AE can request to update, create or delete specific attribute(s) at the target resource by including the name of such attribute(s) and its values in the *Content* parameter of the request message.

Originator: Requests update any of the attributes at the target resource by using UPDATE Request message. The Originator shall send new (proposed) values for the attribute(s) that need to be updated. The UPDATE operation allows to modify or create previously non-existing attributes of the resource type (defined in clause 9.6) that are indicated as "RW" (Read Write) for the specific resource type definition.

The **Originator** requests to delete attributes at the target resource by using UPDATE Request message. The Originator shall send the name of the attributes to be deleted (defined in clause 9.6) for the specific resource type with their value set to NULL, in the Request message.

See clause 8.1.2 for the information to be included in the Request message.

Receiver: The Receiver verifies the existence of the addressed resource, the validity of the attributes provided and the privileges to modify them, the Receiver shall update the attributes provided and shall return a Response message to the Originator with the operation results as specified in clause 8.1.3.

If the attributes provided do not exist, after verifying the existence of the addressed resource, the Receiver validates the attributes provided and the privileges to create them. On successful validation, the Receiver shall create the attributes provided with their associated values and shall return a Response message to the Originator with the operation results as specified in clause 8.1.3.

If the attributes provided have their value set to NULL, after verifying the existence of the addressed resource, the Receiver validates the attributes provided and the privileges to delete them. On successful validation, the Receiver shall delete such attributes and shall return a Response message to the Originator with the operation results as specified in clause 8.1.3.

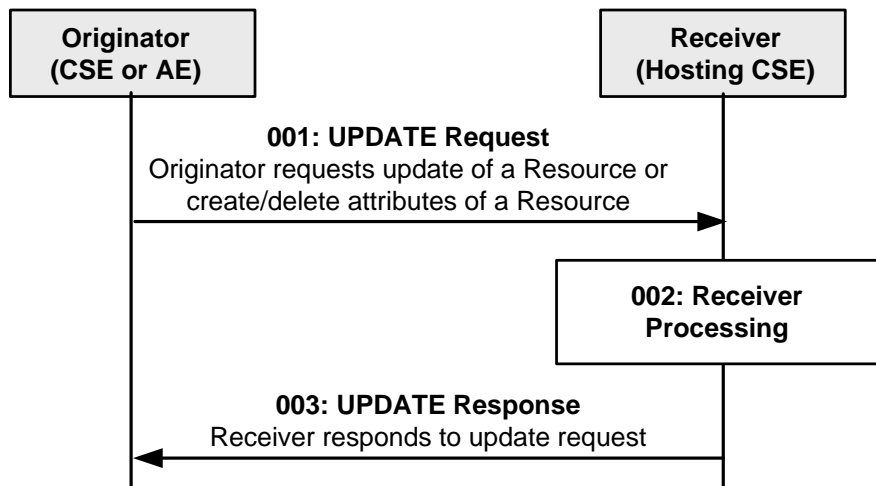

Figure 10.1.3-1: Procedure for UPDATIng a Resource

Step 001: The Originator shall send mandatory parameters and may send optional parameters in Request message for UPDATE operation as specified in clause 8.1.2.

Step 002: The Receiver shall verify the existence (including *Filter Criteria* checking, if it is given) of the requested resource and if the Originator has the appropriate privilege to update the resource. This privilege checking follows the rules defined in the table 9.6.1.3.2-1 (common attributes description). On successful validation, the Receiver shall update the resource as requested. If the attributes provided do not exist, the Receiver shall validate if the Originator has appropriate privileges to create the attributes at the target resource. On successful validation, the Receiver shall create the attributes with their associated values at the resource as requested. If the attributes provided have their value set to NULL, the Receiver shall validate if the Originator has appropriate privileges to delete the attributes at the target resource. On successful validation, the Receiver shall delete such attributes. The Receiver shall check if the updated target resource is a child of a parent resource having a stateTag attribute and increment the stateTag if present.

Step 003: The Receiver shall respond with mandatory parameters and may send optional parameters in Response message for UPDATE operation as specified in clause 8.1.3.

General Exceptions:

- 1) The targeted resource in *To* parameter does not exist. The Receiver responds with an error.
- 2) The Originator does not have the privilege to modify the resource, create attributes or delete attributes on the Receiver. The Receiver responds with error.
- 3) The provided information in the *Content* is not accepted by the Receiver. The Receiver responds with error.

10.1.4 DELETE (D)

10.1.4.0 Introduction

The DELETE operation shall be used by an Originator CSE or AE to delete a resource on a Receiver CSE (also called the Hosting CSE). The description of DELETE procedure has been divided in two separate clauses, since there is a need to distinguish between Deregistration related Delete and Non-Deregistration related Delete procedures.

The Deregistration related Delete procedure is applicable for the following resource types only:

- <AE>; and
- <remoteCSE>

10.1.4.1 Non-deregistration related DELETE procedure

This procedure is valid for all resources which are not related to deregistration.

The DELETE operation shall be used by an Originator CSE or AE to delete a resource at a Receiver CSE. For such operation, the DELETE procedure shall consist of the deletion of all related information of the target resource.

Originator: Requests deletion of a resource by using a DELETE Request message. See clause 8.1.2 for the information to be included in the Request message.

Receiver: he Receiver verifies the existence of the requested resource, and the privileges for deleting the resource.

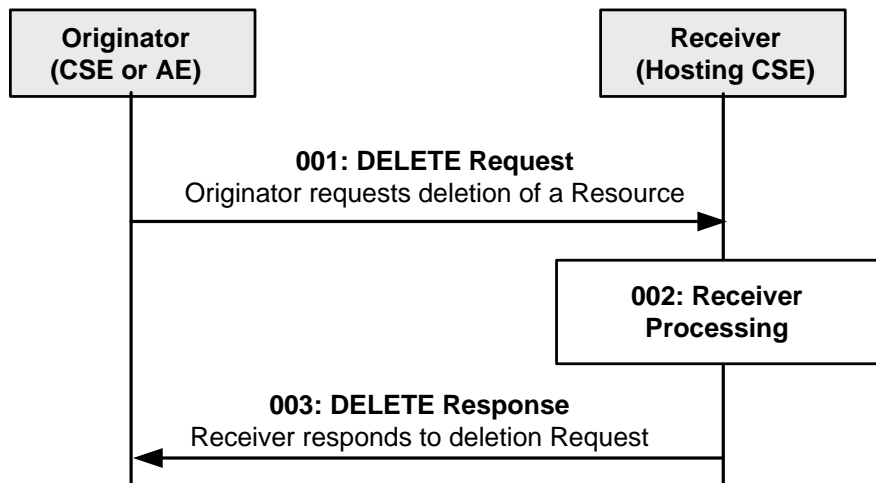

Figure 10.1.4-1: Procedure for DELETING a Resource

Step 001: The Originator shall mandatory parameters and may send optional parameters in Request message for DELETE operation as specified in clause 8.1.2.

Step 002: The Receiver shall verify the existence (including *Filter Criteria* checking, if it is given) of the requested resource and if the Originator has the appropriate privilege to delete the resource. This privilege checking follows the rules defined in the table 9.6.1.3.2-1 (common attributes description). On successful validation, the Receiver shall check for child resources and delete all child resources and the associated references in parent resources and it shall remove the resource itself. The Receiver shall check if the deleted child resource leads to changes in its parent resource's attribute(s), if so the parent resource's attribute(s) shall be updated.

Step 003: The Receiver shall respond with mandatory parameters and may send optional parameters in Response message for DELETE operation as specified in clause 8.1.3.

General Exceptions:

- 1) The targeted resource in *To* information does not exist. The Receiver responds with an error.
- 2) The Originator does not have the privileges to delete the resource on the Receiver. The Receiver responds with an error.

10.1.4.2 Deregistration related DELETE procedure

10.1.4.2.0 Overview

This clause describes the DELETE procedure for <remoteCSE> and <AE> resource type.

10.1.4.2.1 CSE Deregistration procedure

The procedure for CSE Deregistration follows the procedure described in clause 10.1.4.1, but with some exceptions. Below is the detailed description on how to perform the CSE Deregistration and which part of the procedure deviates from the one described in clause 10.1.4.1.

The Deregistration procedure accompanies the deletion of two resources (a <remoteCSE> on the Hosting CSE and a <remoteCSE> on the Originator CSE) rather than one resource. The Deregistration procedure can be initiated by either Registree CSE or Registrar CSE.

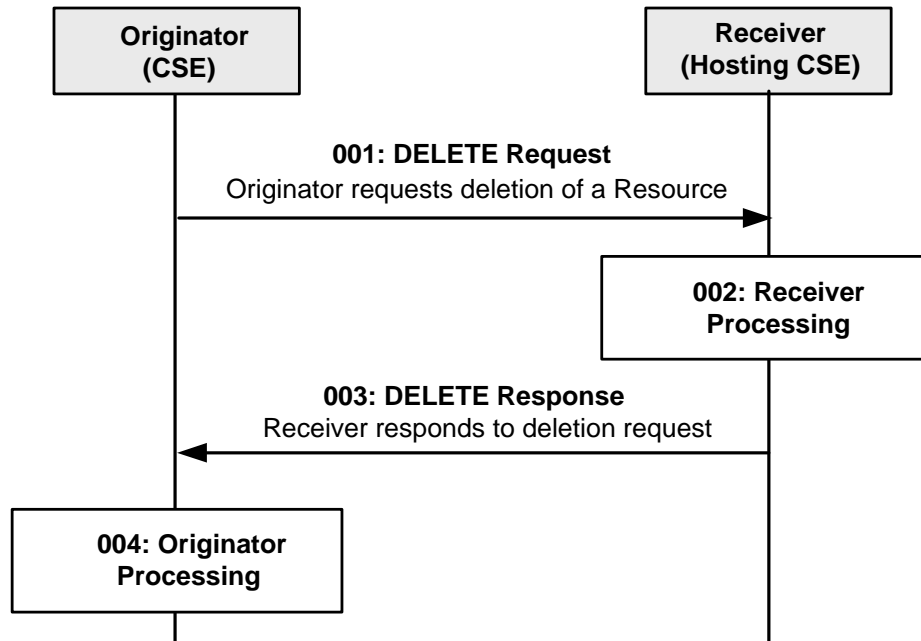

Figure 10.1.4.2.1-1: Procedure for DELETING a <remoteCSE> Resource

Step 001: See clause 10.1.4.1.

Step 002: See clause 10.1.4.1.

Step 003: See clause 10.1.4.1.

Step 004: The Originator, upon receipt of the DELETE response, shall delete a <remoteCSE> resource locally under its <CSEBase> resource.

General Exceptions:

All exceptions from 10.1.4.1 are applicable; in addition the following exception may occur:

- 1) If the Receiver rejects the DELETE request and responds with an error in the DELETE response, the Originator cannot perform the action described in the step 004.

10.1.4.2.2 Application Entity Deregistration procedure

Application Entity Deregistration is performed by requesting a Delete operation for the <AE> resource representing the Application Entity.

In case an <AE> resource hosted on a MN-CSE or ASN-CSE with AE-ID-Stem starting with "S" is requested to be deleted, the <AEAnnC> resource that was created on the IN-CSE during the initial registration of the associated Application Entity shall be updated with an empty value for the link attribute, indicating that the associated Application Entity is currently not registered. After this update of the <AEAnnC> resource is completed, the procedure for AE Deregistration shall follow the procedure described in clause 10.2.1.4.

In case an <AE> resource with AE-ID-Stem not starting with "S" is requested to be deleted, the procedure for AE Deregistration follows the procedure described in clause 10.1.4.1.

10.1.5 NOTIFY (N)

The NOTIFY operation shall be used for notifying information. All the specific notification procedures defined in this present document are listed in clause 10.3 (Notification procedures).

Originator: The Originator requests to notify an entity by using NOTIFY method. See clause 8.1.2 for the information to be included in a Request message.

Receiver: The Receiver responds to the Originator with the operation results as specified in clause 8.1.3.

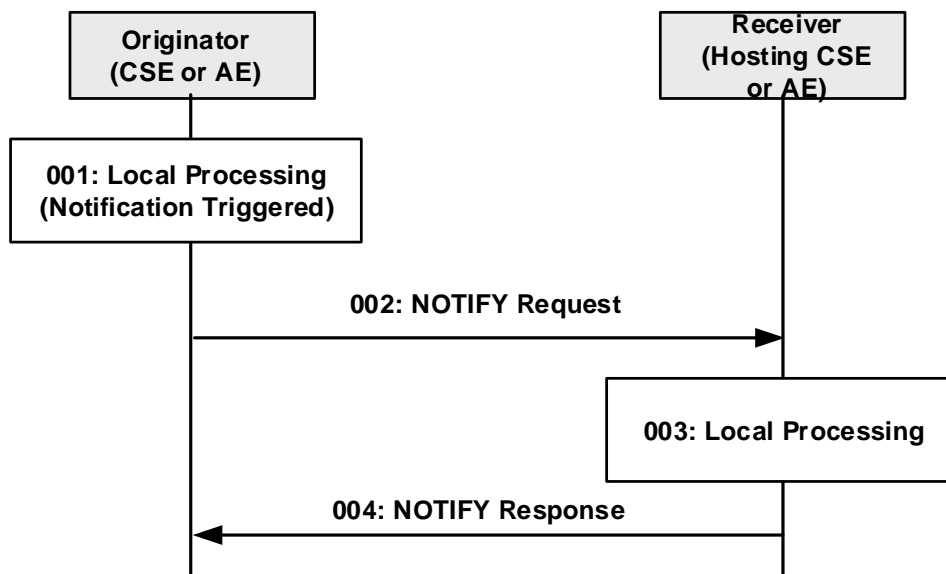

Figure 10.1.5-1: Procedure for NOTIFYing Information

Step 001: A notification to be sent to the Receiver is triggered in the Originator.

Step 002: The Originator shall send mandatory parameters and may send optional parameters in Request message for NOTIFY operation as specified in clause 8.1.2.

Step 003: Local Processing.

Step 004: The Receiver shall respond with mandatory parameters and may send optional parameters in Response message for NOTIFY operation as specified in clause 8.1.3.

General Exceptions:

- See oneM2M TS-0003 [2].

10.2 Resource Type-Specific Procedures

10.2.0 Overview

The basic procedure for the corresponding operations as specified in clause 10.1 shall be performed with the modifications specific to the resource type procedures as described in clause 10.2.

For resources without defined resource type-specific operations, the basic operations in clause 10.1 shall apply.

10.2.1 <AE> Resource Procedures

10.2.1.1 Create <AE>

This procedure shall be used for creating an <AE> resource. This operation is part of the registration procedure for AEs on the Registrar CSE (which is also the Hosting CSE), as described in clause 10.1.1.2.2.

Table 10.2.1.1-1: <AE> CREATE

<AE> CREATE	
Associated Reference Point	Mca
Information in Request message	All parameters defined in table 8.1.2-3 apply with the specific details for: From: Registree AE only Content: The resource content shall provide the information as defined in clause 9.6.5
Processing at Originator before sending Request	According to clause 10.1.1.2.2
Processing at Receiver	According to clause 10.1.1.2.2
Information in Response message	All parameters defined in table 8.1.3-1
Processing at Originator after receiving Response	According to clause 10.1.1.2.2
Exceptions	According to clause 10.1.1.2.2

10.2.1.2 Retrieve <AE>

This procedure shall be used for retrieving the representation of the <AE> resource.

Table 10.2.1.2-1: <AE> RETRIEVE

<AE> RETRIEVE	
Associated Reference Point	Mca, Mcc and Mcc'
Information in Request message	All parameters defined in table 8.1.2-3
Processing at Originator before sending Request	According to clause 10.1.2
Processing at Receiver	According to clause 10.1.2
Information in Response message	All parameters defined in table 8.1.3-1 apply with the specific details for: Content: attributes of the <AE> resource as defined in clause 9.6.5
Processing at Originator after receiving Response	According to clause 10.1.2
Exceptions	According to clause 10.1.2

10.2.1.3 Update <AE>

This procedure shall be used for updating the attributes and the actual data of an <AE> resource.

Table 10.2.1.3-1: <AE> UPDATE

<AE> UPDATE	
Associated Reference Point	Mca, Mcc and Mcc'
Information in Request message	All parameters defined in table 8.1.2-3 apply with the specific details for: Content: attributes of the <AE> resource as defined in clause 9.6.5 which need be updated
Processing at Originator before sending Request	According to clause 10.1.3
Processing at Receiver	According to clause 10.1.3 If the <i>pointOfAccess</i> attribute is updated and there are any messages in the buffer for store-and-forward procedure, Receiver shall send all buffered messages
Information in Response message	According to clause 10.1.3
Processing at Originator after receiving Response	According to clause 10.1.3
Exceptions	According to clause 10.1.3

10.2.1.4 Delete <AE>

This procedure shall be used for deleting the <AE> resource with all related information.

Table 10.2.1.4-1: <AE> DELETE

<AE> DELETE	
Associated Reference Point	Mca, Mcc and Mcc'
Information in Request message	All parameters defined in table 8.1.2-3 apply
Processing at Originator before sending Request	According to clause 10.1.4
Processing at Receiver	According to clause 10.1.4
Information in Response message	According to clause 10.1.4
Processing at Originator after receiving Response	According to clause 10.1.4
Exceptions	According to clause 10.1.4

10.2.1.5 Notify <AE>

This procedure shall be used for sending a Notify request to an <AE> resource. This procedure is used for sending notification data to an AE. In this description, the Receiver is the CSE hosting the <AE>.

Table 10.2.1.5-1: <AE> NOTIFY

<AE> NOTIFY	
Associated Reference Point	Mca, Mcc and Mcc'
Information in Request message	All parameters defined in table 8.1.2-3 apply
Processing at Originator before sending Request	According to clause 10.1.5
Processing at Receiver	The Hosting CSE shall re-target the Notify request to the AE according to clause 9.3.2.3.1
Information in Response message	According to clause 10.1.5
Processing at Originator after receiving Response	According to clause 10.1.5
Exceptions	According to clause 10.1.5

10.2.2 <remoteCSE> Resource Procedures

10.2.2.1 Create <remoteCSE>

This procedure shall be used for creating a <remoteCSE> resource. It is part of the registration procedure for remote CSEs on the Registrar CSE (which is also the Hosting CSE), as described in clause 10.1.1.2.1.

Table 10.2.2.1-1: <remoteCSE> CREATE

<remoteCSE> CREATE	
Associated Reference Point	Mcc and Mcc'
Information in Request message	All parameters defined in table 8.1.2-3 apply with the specific details for: From: Originator CSE-ID Content: The resource content shall provide the information as defined in clause 9.6.4
Processing at Originator before sending Request	According to clause 10.1.1.2.1
Processing at Receiver	According to clause 10.1.1.2.1 If the IN-CSE is the receiver and if the M2M SP policies do allow access to the CSEs across multiple domains, then the IN shall create the appropriate entry in the M2M SP's DNS for successfully registered CSE
Information in Response message	All parameters defined in table 8.1.3-1 apply with the specific details for: Content: Address of the created <remoteCSE> resource, according to clause 10.1.1.2.1
Processing at Originator after receiving Response	According to clause 10.1.1.2.1. the Originator upon receipt of successful CREATE response message, shall create <remoteCSE> resource locally and thereafter, it may issue a Retrieve request to its Registrar CSE's <CSEBase> resource to update the optional attributes of locally created <remoteCSE> resource
Exceptions	According to clause 10.1.1.2.1

10.2.2.2 Retrieve <remoteCSE>

This procedure shall be used for retrieving the representation of the <remoteCSE> resource with its attributes.

Table 10.2.2.2-1: <remoteCSE> RETRIEVE

<remoteCSE> RETRIEVE	
Associated Reference Point	Mca, Mcc and Mcc'
Information in Request message	All parameters defined in table 8.1.2-3 apply
Processing at Originator before sending Request	According to clause 10.1.2
Processing at Receiver	According to clause 10.1.2
Information in Response message	All parameters defined in table 8.1.3-1 apply with the specific details for: Content: attributes of the <remoteCSE> resource as the Originator requested
Processing at Originator after receiving Response	According to clause 10.1.2
Exceptions	According to clause 10.1.2

10.2.2.3 Update <remoteCSE>

This procedure shall be used for updating the attributes and the actual data of an <remoteCSE> resource.

Table 10.2.2.3-1: <remoteCSE> UPDATE

<remoteCSE> UPDATE	
Associated Reference Point	Mcc and Mcc'
Information in Request message	All parameters defined in table 8.1.2-3 apply with the specific details for: Content: attributes of the <remoteCSE> resource as defined in clause 9.6.4 which need be updated
Processing at Originator before sending Request	According to clause 10.1.3
Processing at Receiver	According to clause 10.1.3 If the <i>pointOfAccess</i> attribute is updated and there are any messages in the buffer for store-and-forward procedure, Receiver shall send all buffered messages
Information in Response message	According to clause 10.1.3
Processing at Originator after receiving Response	According to clause 10.1.3
Exceptions	According to clause 10.1.3

10.2.2.4 Delete <remoteCSE>

This procedure shall be used for deleting the <remoteCSE> resource with all related information.

Table 10.2.2.4-1: <remoteCSE> DELETE

<remoteCSE> DELETE	
Associated Reference Point	Mca, Mcc and Mcc'
Information in Request message	All parameters defined in table 8.1.2-3 apply
Processing at Originator before sending Request	According to clause 10.1.4
Processing at Receiver	According to clause 10.1.4 If the IN-CSE is the receiver and it has created an entry in the DNS to allow access to the CSE across multiple M2M domains, then it shall delete the entry from the DNS
Information in Response message	According to clause 10.1.4
Processing at Originator after receiving Response	According to clause 10.1.4
Exceptions	According to clause 10.1.4

10.2.3 <CSEBase> Resource Procedures

10.2.3.1 Create <CSEBase>

The Create procedure shall be not apply to <CSEBase>. <CSEBase> can be created via management operation not defined in this version of the specification.

10.2.3.2 Retrieve <CSEBase>

This procedure shall be used for retrieving the representation of the <CSEBase> resource with its attributes.

Table 10.2.3.2-1: <CSEBase> RETRIEVE

<CSEBase> RETRIEVE	
Associated Reference Point	Mca, Mcc and Mcc'
Information in Request message	All parameters defined in table 8.1.2-3 apply
Processing at Originator before sending Request	According to clauses 10.1.2 and 10.1.1.2.1
Processing at Receiver	According to clauses 10.1.2 and 10.1.1.2.1
Information in Response message	All parameters defined in table 8.1.3-1 apply with the specific details for: Content: attributes of the <CSEBase> resource as requested by the Originator
Processing at Originator after receiving Response	According to clauses 10.1.2 and 10.1.1.2.1 When this procedure is used during CSE Registration, a <remoteCSE> resource is created using the retrieved resource
Exceptions	According to clauses 10.1.2 and 10.1.1.2.1

10.2.3.3 Update <CSEBase>

The Update procedure shall not apply to <CSEBase>. <CSEBase> can be updated via management operation not defined in this version of the specification.

10.2.3.4 Delete <CSEBase>

The Delete procedure shall not apply to <CSEBase>. <CSEBase> can be deleted via management operation not defined in this version of the specification.

10.2.3.5 Notify <CSEBase>

This procedure shall be used for sending a Notify request to a <CSEBase> resource. This procedure is used for sending notification data to a CSE. In this description, the Receiver is the Hosting CSE of the <CSEBase> resource.

Table 10.2.3.5-1: <CSEBase> NOTIFY

<CSEBase> NOTIFY	
Associated Reference Point	Mca, Mcc and Mcc'
Information in Request message	All parameters defined in table 8.1.2-3 apply
Processing at Originator before sending Request	According to clause 10.1.5
Processing at Receiver	According to clause 10.1.5.
Information in Response message	According to clause 10.1.5
Processing at Originator after receiving Response	According to clause 10.1.5
Exceptions	According to clause 10.1.5

10.2.4 <container> Resource Procedures

10.2.4.1 Create <container>

This procedure shall be used for creating a <container> resource.

Table 10.2.4.1-1: <container> CREATE

<container> CREATE	
Associated Reference Point	Mca, Mcc and Mcc'
Information in Request message	All parameters defined in table 8.1.2-3 apply with the specific details for: Content: The resource content shall provide the information as defined in clause 9.6.6
Processing at Originator before sending Request	According to clause 10.1.1.1
Processing at Receiver	According to clause 10.1.1.1
Information in Response message	All parameters defined in table 8.1.3-1 apply with the specific details for: Content: Address of the created <container> resource, according to clause 10.1.1.1
Processing at Originator after receiving Response	According to clause 10.1.1.1
Exceptions	According to clause 10.1.1.1

10.2.4.2 Retrieve <container>

This procedure shall be used for retrieving the attributes of a <container> resource.

Table 10.2.4.2-1: <container> RETRIEVE

<container> RETRIEVE	
Associated Reference Point	Mca, Mcc and Mcc'.
Information in Request message	All parameters defined in table 8.1.2-3 apply with the specific details for: Content: void.
Processing at Originator before sending Request	According to clause 10.1.2.
Processing at Receiver	The Receiver shall verify the existence (including Filter Criteria checking, if it is given) of the target resource or the attribute and check if the Originator has appropriate privileges to retrieve information stored in the resource/attribute. When the child <contentInstance> resource has to be part of the response (ResultContent is child-resources or attributes+child-resources) and there is no <contentInstance> resource in the parent or if all existing ones are obsolete then 2 situations: <ul style="list-style-type: none"> a) there is a subscription on the <container> resource with the notificationEventType 'e' set (oneM2M TS-0001, table 9.6.8-3) so a notification is triggered, a timer shall be set and the Receiver shall delay the response until a <contentInstance> resource is available in the <container> resource, or until the timer expires; in that last case the Receiver shall respond with an error. If the Result Expiration Timestamp parameter is received from the Originator, the timer should be set to enforce this parameter, otherwise, the timer is set, based on the local policy configured at the Hosting CSE. b) there is no subscription on the <container> resource with the notificationEventType 'e' set, then the Receiver shall respond with an error. Otherwise clause 10.1.2 applies.
Information in Response message	All parameters defined in table 8.1.3-1 apply with the specific details for: Content: attributes of the <container> resource as defined in clause 9.6.6.
Processing at Originator after receiving Response	According to clause 10.1.2.
Exceptions	According to clause 10.1.2. In addition : a timer has expired. The Receiver responds with an error.

10.2.4.3 Update <container>

This procedure shall be used for updating the attributes and the actual data of a <container> resource.

Table 10.2.4.3-1: <container> UPDATE

<container> UPDATE	
Associated Reference Point	Mca, Mcc and Mcc'
Information in Request message	All parameters defined in table 8.1.2-3 apply with the specific details for: Content: attributes of the <container> resource as defined in clause 9.6.6 which need be updated
Processing at Originator before sending Request	According to clause 10.1.3
Processing at Receiver	According to clause 10.1.3
Information in Response message	According to clause 10.1.3
Processing at Originator after receiving Response	According to clause 10.1.3
Exceptions	According to clause 10.1.3

10.2.4.4 Delete <container>

This procedure shall be used for deleting a <container> resource.

Table 10.2.4.4-1: <container> DELETE

<container> DELETE	
Associated Reference Point	Mca, Mcc and Mcc'
Information in Request message	All parameters defined in table 8.1.2-3 apply
Processing at Originator before sending Request	According to clause 10.1.4.1
Processing at Receiver	According to clause 10.1.4.1.
Information in Response message	According to clause 10.1.4.1
Processing at Originator after receiving Response	According to clause 10.1.4.1
Exceptions	According to clause 10.1.4.1

10.2.5 Access to Remotely Hosted Resources via <delivery>

10.2.5.1 Introduction to usage of <delivery> resource type

In this introduction an example for delivering information from a source CSE to a target CSE via the use of the <delivery> resource is explained.

The information flow depicted in figure 10.2.5.1-1 defines the exchange of Requests/Responses for processing an original request targeting a resource that is not hosted on the Registrar CSE of the request Originator. The following assumptions hold:

- Originator is AE1.
- AE1 is registered with CSE1, i.e. CSE1 is the Registrar CSE for AE1.
- The original Request is an UPDATE to a remote resource hosted on CSE3, i.e. CSE3 is the Hosting CSE for the target resource.
- UPDATE options in the original Request are selected such that no feedback after completion of the update operation was requested, i.e. AE1 decided that it does not need to hear back from CSE3; this is expressed by setting the **Result Content** information to "nothing", see clause 8.1.2.
- Delivery related parameters included in the original UPDATE request (may be set via CMDH policies):
Request Expiration Timestamp, **Event Category**, **Delivery Aggregation** and **Result Persistence**:
 - **Request Expiration Timestamp** indicates how long the forwarding of the request can last.
 - **Event Category** indicates the event category that should be used by CMDH to handle this request.
 - **Result Persistence** indicates how long after the request has expired, the local request context should still be available for retrieving status or result information.
 - **Delivery Aggregation** would be set to ON indicating that <delivery> resource shall be used for forwarding the request.
- CSE1 is the CSE of an Application Service Node.
- CSE1 is registered with CSE2 and interacts with CSE2 via the reference point Mcc(1).
- CSE2 is the CSE of a Middle Node.

- CSE2 is registered with CSE3 and interacts with CSE3 via the reference point Mcc(2).
- CSE3 is the CSE of an Infrastructure Node.

The Originator AE1 shall get a confirmation from CSE1 when the original Request is accepted. The response informs AE1 that CSE1 has accepted the Request and has accepted responsibility to execute on the requested operation. Furthermore, AE1 has expressed by setting **Result Content** to "nothing" that no result of the requested operation is expected to come back from CSE3. With the provided reference (Req-Ref in figure 10.2.5.1-1. AE1 can retrieve the status of the issued request at a later time, for instance to find out if the request was already forwarded to CSE2 or if it is still waiting for being forwarded on CSE1. Before accepting the request from AE1, CSE1 has also verified if the delivery related parameters expressed by AE1 (settings of **Request Expiration Timestamp** and **Event Category**) are in line with provisioned CMDH policies. AE1 may not be authorized to use certain values for **Request Expiration Timestamp** or **Event Category**.

In line with the delivery related parameters, CSE1 is generating a local <delivery> resource on CSE1 and attempts to forward the content of it in line with provisioned CMDH policies at a suitable time and via a suitable connection to CSE2 by requesting the creation of a <delivery> resource on CSE2. In this example case, the *lifespan* attribute of this delivery resource is set to the same value as the **Request Expiration Timestamp** parameter expressed by AE1. In general - i.e. also in cases where more than one original request is aggregated into a single create request for a <delivery> resource - the *lifespan* and *eventCat* attributes of the created <delivery> resource shall be set consistent with the **Request Expiration Timestamp** and **Event Category** parameters in the set of original requests. See the attribute definitions in clause 9.6.11.

CSE1 shall use a blocking request for requesting creation of a <delivery> resource on CSE2.

When CSE2 has accepted the incoming request from CSE1, CSE1 may delete the *aggregatedRequest* attribute of the local <delivery> resource. Furthermore - if the expiration time of the local <delivery> resource is not exhausted - the Registrar CSE shall update *deliveryMetaData* attribute of the local <delivery> resource to indicate that it has been forwarded to CSE2.

When CSE2 has accepted the request to create a local <delivery> resource, it shall attempt to forward it to CSE3. In line with the delivery related parameters, CSE2 shall create a local <delivery> resource on CSE2 and shall attempt to forward it in line with provisioned CMDH policies at a suitable time and via a suitable connection to CSE3 by requesting the creation of a <delivery> resource on CSE3.

CSE2 shall use a blocking request for requesting creation of a <delivery> resource on CSE3.

When CSE3 has accepted the incoming request from CSE2, CSE2 may delete the *aggregatedRequest* attribute of the local <delivery> resource. Furthermore - if the expiration time of the local <delivery> resource is not exhausted - the Registrar CSE shall update *deliveryMetaData* attribute of the local <delivery> resource to indicate that it has been forwarded to CSE3.

When CSE3 has accepted the request to create a local <delivery> resource, it shall determine that the target of the delivery was CSE3 itself. Therefore it shall forward internally the original request contained in the *aggregatedRequest* attribute of the <delivery> resource.

Within CSE3, functions that are responsible for checking and executing local access to resources in CSE3 will execute the originally requested UPDATE operation. If successful, the targeted resource will be updated with the content provided by the Originator.

Since in the depicted case no result needed to be sent back to the Originator, the processing for the requested operation is then completed.

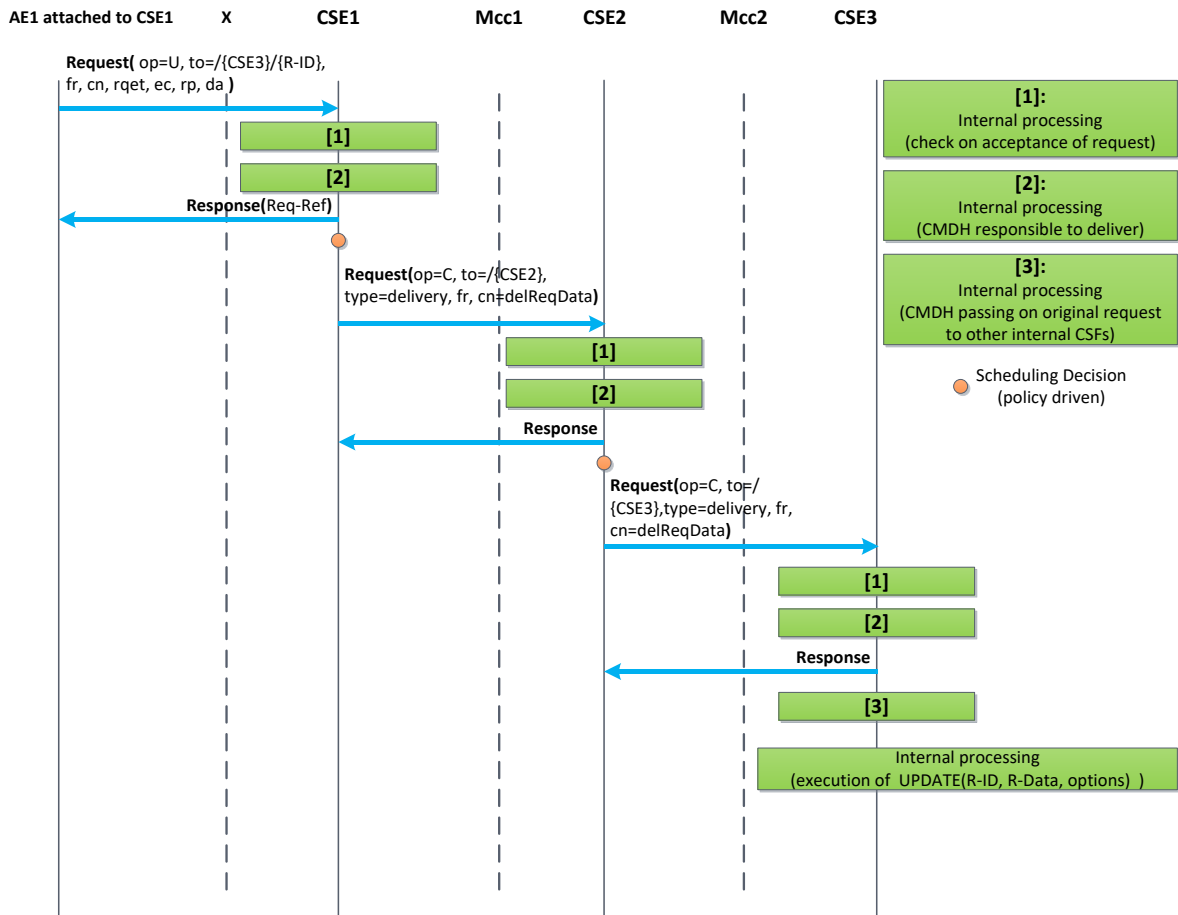

Figure 10.2.5.1-1: CMDH information flow for 2 hops - no result needs to be returned after operation completes

The following procedures shall be triggered by requesting the corresponding operations on a *<delivery>* resource:

- Initiate the delivery of one or more original request(s) stored for later forwarding from one CSE to another CSE:
 - Request a CREATE operation for a *<delivery>* resource from an issuing CSE to a receiving CSE.
 - The original request(s) need to be contained in the "aggregatedRequest" attribute of the *<delivery>* resource.
 - If successful, the receiving CSE takes the responsibility to further execute on the delivery process for the original Request.
 - If not successful, the issuing CSE cannot assume that the receiving CSE will carry out the delivery of the original request.
- Get information about the status of a pending delivery process for an original request:
 - Request a RETRIEVE operation of the content of a *<delivery>* resource representing a pending delivery or part of it.
 - The status of the pending forwarding process is reflected the "deliveryMetaData" attribute defined in the *<delivery>* resource.
- Change parameters of pending delivery process:
 - Request an UPDATE operation on applicable attributes of the *<delivery>* resource representing the pending delivery.

- For instance the time allowed for completion of a delivery process could be modified by updating the "lifespan" attribute of an existing <delivery> resource.
- Cancel a pending delivery request:
 - Request a DELETE operation of a <delivery> resource that represents a pending delivery process.

10.2.5.2 Create <delivery>

This procedure shall be used for requesting a CSE to take responsibility to deliver the provided data to a target CSE in line with CMDH parameters and provisioned CMDH policies in case <delivery> resource based CMDH processing is used. If indicated by the Originator, the Receiver shall confirm the acceptance of delivery responsibility by a successful Response.

Originator: The Originator of a Create request for a <delivery> resource can only be a CSE. The Originator needs to provide the content of a <delivery> resource type together with the Create request or can Update it after a successful creation of the <delivery> resource with empty *aggregatedRequest* attribute. Otherwise the Receiver cannot accept the Create Request. The Originator shall use a blocking request for issuing the Create request to the Receiver.

Receiver: The receiver of a Create request for a <delivery> resource is a Registrar or Registree CSE of the Originator and it shall check the access control policies to assure the Originator is authorized to request a delivery procedure. The Receiver of the Create Request shall further check whether the provided attributes of the <delivery> resource that is requested to be created represents a valid request for forwarding data to a target CSE. If the Originator of the Create request is authorized and the Request is valid, the Receiver shall check whether it can actually satisfy the requested delivery in line with provisioned CMDH policies and requested *eventCat* and *lifespan* attributes of the <delivery> resource. If all these checks are positive, the Receiver shall create the requested <delivery> resource and assumes responsibility for delivering the requested data to the target CSE as soon as the content of the *aggregatedRequest* attribute is available. In case an operation result is expected by the Originator, the Receiver shall confirm acceptance of the responsibility by indicating a successful creation of the <delivery> resource. If the Receiver CSE is the target CSE of the requested delivery, it shall forward the content of the delivered data - which represents one or more forwarded original request(s) - to the internal functions that handle incoming requests and continue processing of the forwarded request(s).

Table 10.2.5.2-1: <delivery> CREATE

<delivery> CREATE	
Associated Reference Point	Mcc and Mcc'
Information in Request message	All parameters defined in table 8.1.2-3 apply with the specific details for: From: CSE only Content: The resource content shall provide the information as defined in clause 9.6.11 Response Type: Shall be set to "blockingRequest" which means a blocking request is issued
Processing at Originator before sending Request	According to clause 10.1.1.1 with the following specific processing: The Originator needs to provide the content of a <delivery> resource type together with the Create request or can Update it after a successful creation of the <delivery> resource with empty <i>aggregatedRequest</i> attribute. Otherwise the Receiver cannot accept the Create Request. The Originator shall use a blocking request for issuing the Create request to the Receiver
Processing at Receiver	According to clause 10.1.1.1 with the following specific processing: <ul style="list-style-type: none"> • Check whether the provided attributes of the <delivery> resource that is requested to be created represents a valid request for delivering data to a target CSE • Check whether Receiver CSE can actually satisfy the requested delivery in line with provisioned policies and requested delivery parameters • If all checks are positive, the receiver shall create the requested <delivery> resource and assumes responsibility for delivering the provided data to the target CSE • If the Receiver CSE is the target CSE of the requested delivery, it shall forward the content of the delivered data to the internal CSFs that will interpret the delivered data as a forwarded request(s) from a remote Originator
Information in Response message	All parameters defined in table 8.1.3-1 apply, with the following specific information: In case the Originator CSE has not asked for a Result of the requested Operation (Result Content set to "nothing"), the Response only contains an Acknowledgement indicator. This only indicates that the Receiver CSE received the Request. It does NOT indicate whether the Receiver CSE was able to take on responsibility for delivery of the data In case the Originator CSE asked for the status of the requested Operation to be contained in the Result of the requested Operation (Result Content not set to "nothing"), the Receiver CSE shall respond with a Success or Failure indicator In case the Originator CSE asked for the status of the requested Operation and the address of the created Resource to be contained in the Result of the Request, the Receiver CSE shall respond with a Success indicator including the address of the created <delivery> resource in case it has taken on responsibility to deliver the data to the target CSE or with Failure indicator including an error indication otherwise
Processing at Originator after receiving Response	According to clause 10.1.1.1 with the following specific processing: The Originator CSE shall update the local <delivery> resource to reflect the new status of the delivery process (e.g. '{Receiver-CSE-ID} accepted delivery responsibility') In case the Originator CSE got a Success indicator as a Response, it shall stop any further delivery attempts. In that case or if there was no indication of a need to provide a result of the operation, the Originator CSE may delete the content of the <i>'aggregatedRequest'</i> attribute of the local <delivery> resource In case the Originator CSE got a Failure indicator as a response, it may initiate further delivery attempts in line with CMDH policies and delivery parameters and depending on the reason for Failure In case the Receiver CSE is the target CSE of the delivery, the Receiver CSE needs to execute on the forwarded request contained in the delivered data

<delivery> CREATE	
Exceptions	According to clause 10.1.1.1 with the following: <ul style="list-style-type: none"> • The Originator CSE is not authorized to request a delivery procedure on the Receiver CSE • The provided content of the <delivery> resource is not in line with the specified structure • The provided content of the <delivery> resource represents a request for delivery that is not consistent (e.g. lifespan attribute already expired) • The provided content of the <delivery> resource represents a request for delivery that cannot be met by the Receiver CSE within the limits of the provided delivery parameters and the provisioned CMDH policies on the Receiver CSE

10.2.5.3 Retrieve <delivery>

This procedure shall be used for requesting a CSE to provide information on a previously created <delivery> resource which represents delivery of data to a target CSE.

Table 10.2.5.3-1: <delivery> RETRIEVE

<delivery> RETRIEVE	
Associated Reference Point	Mcc and Mcc'
Information in Request message	All parameters defined in table 8.1.2-3 apply with the specific details for: Content: void
Processing at Originator before sending Request	According to clause 10.1.2 with the following specific processing: Originator needs to retrieve information about a previously issued delivery
Processing at Receiver	According to clause 10.1.2 with the following specific processing: The Receiver shall provide the content of the addressed <delivery> resource or the addressed attributes thereof
Information in Response message	All parameters defined in table 8.1.3-1 apply with the specific details for: Content: attributes of the <delivery> resource as defined in clause 9.6.11
Processing at Originator after receiving Response	According to clause 10.1.2
Exceptions	According to clause 10.1.2 with the following: <ul style="list-style-type: none"> • The Originator CSE is not authorized to retrieve the <delivery> resource or the addressed parts of it • The addressed <delivery> resource does not exist

10.2.5.4 Update <delivery>

This procedure shall be used for requesting a CSE to update information on a previously created <delivery> resource which represents a pending delivery of data to a target CSE. The update may have impact on further processing of the delivery.

Table 10.2.5.4-1: <delivery> UPDATE

<delivery> UPDATE	
Associated Reference Point	Mcc and Mcc'
Information in Request message	All parameters defined in table 8.1.2-3 apply with the specific details for: <ul style="list-style-type: none"> • Address of the <delivery> resource • Content of a <delivery> resource in line with the definition in clause 9.6.11 representing a valid request for delivery of data to a target CSE
Processing at Originator before sending Request	According to clause 10.1.3 with the following specific processing: <ul style="list-style-type: none"> • Originator needs to modify information about a previously issued delivery that is still pending, i.e. it has not yet been forwarded to another CSE
Processing at Receiver	According to clause 10.1.3 with the following specific processing: <ul style="list-style-type: none"> • Receiver CSE checks if the requested changes to the delivery process can actually be accomplished • If possible, the Receiver CSE modifies the previously established delivery process and changes the respective content of the <delivery> resource
Information in Response message	According to clause 10.1.3
Processing at Originator after receiving Response	According to clause 10.1.3
Exceptions	According to clause 10.1.3 with the following: <ul style="list-style-type: none"> • The Originator CSE is not authorized to modify the <delivery> resource or the addressed parts of it • The addressed <delivery> resource does not exist • The responsibility for the further processing of the delivery process represented by the addressed <delivery> process was already forwarded to another CSE

10.2.5.5 Delete <delivery>

This procedure shall be used for requesting a CSE to cancel a pending delivery of data to a target CSE or to delete the <delivery> resource of an already executed delivery.

Table 10.2.5.5-1: <delivery> DELETE

<delivery> DELETE	
Associated Reference Point	Mcc and Mcc'
Information in Request message	All parameters defined in table 8.1.2-3 apply
Processing at Originator before sending Request	According to clause 10.1.4 with the following: <ul style="list-style-type: none"> • Originator needs to cancel a previously issued delivery that is still pending, i.e. it has not yet been forwarded to another CSE or Originator needs to remove the <delivery> resource representing an already executed delivery
Processing at Receiver	According to clause 10.1.4: <ul style="list-style-type: none"> • Receiver CSE checks if the corresponding delivery process is still pending. If so, it stops that delivery process • Receiver CSE removes the addressed <delivery> resource and stop the corresponding delivery process if it is still pending
Information in Response message	According to clause 10.1.4 with the following specific information: <ul style="list-style-type: none"> • Successful Response messages indicate that the delivery process was stopped as requested
Processing at Originator after receiving Response	According to clause 10.1.4
Exceptions	According to clause 10.1.4 with the following: <ul style="list-style-type: none"> • The Originator CSE is not authorized to delete the <delivery> • The addressed <delivery> resource does not exist

10.2.6 Resource Discovery Procedures

10.2.6.1 Introduction

The resource discovery procedures allow discovering of resources residing on a CSE. The use of the **Filter Criteria** parameter allows limiting the scope of the results.

Resource discovery shall be accomplished using the RETRIEVE method by an Originator which shall also include the root of where the discovery begins: e.g. <CSEBase>. The unfiltered result of the resource discovery procedure includes all the child resources under the root of where the discovery begins, which the Originator has a Discover access right on. For the allowed *Result Content* parameter options for Discovery related RETRIEVE see clause 8.1.2.

Filter criteria conditions may be provided as parameters to the RETRIEVE method. The filter criteria conditions describe the rules for resource discovery, e.g. resource types, creation time and matching string. The filter criteria can also contain the parameters for specifying the maximum number of discovered resources included in the response, the maximum limit on the number of levels in the resource tree (starting from the target resource) that the Hosting CSE shall perform the discovery request upon and an offset for specifying the number of discovered resources the Hosting CSE shall skip over and not include within the response. Table 8.1.2-2 describes the **Filter Criteria** parameter.

A match shall happen when a resource matches the configured filter criteria conditions and the Originator has a Discover access right on the resource. A successful response contains a list for the matched resources addressable in any of the forms expressed in clause 9.3.1 if matches are found. If no matches are found, a successful response returns no matched resources. If **Discovery Result Type** parameter is specified in a discovery request, the Hosting CSE shall choose the addressing form specified by the **Discovery Result Type** parameter.

The discovery results may be modified by the Hosting CSE to restrict the scope of discoverable resources according to the Originator's access control policy or M2M service subscription.

The Hosting CSE may also implement a configured upper limit on the size of the answer. In such a case when the Originator and the Hosting CSE have different upper limits, the smaller of the two shall apply.

10.2.6.2 Discovery procedure via Retrieve Operation

This procedure shall be used for the discovery of resources under <CSEBase> that match the provided **Filter Criteria** parameter. The discovery result shall be returned to the Originator using a successful Response message.

Table 10.2.6.2-1: Discovery procedure via Retrieve Operation

<resource> RETRIEVE	
Associated Reference Point	Mca, Mcc and Mcc'.
Information in Request message	All parameters defined in table 8.1.2-3 apply with the specific details for: For the allowed <i>Result Content</i> parameter options for Discovery related RETRIEVE see clause 8.1.2. To: Address of the root of where the discovery begins. Filter Criteria: Filter criteria for searching and expected returned result. The <i>filterUsage</i> parameter shall be set in this case. Discovery Result Type: optional, format of discovery results returned (see clause 8.1.2 for options applicable to Discovery, and how results shall be displayed).
Processing at Originator before sending Request	According to clause 10.1.2 with the following: <ul style="list-style-type: none"> • Setup the RETRIEVE operation in the Request. • Include the conditions in the filter criterion to limit the scope of the discovery results. • Specify the desired format of returned discovery results.

Processing at Receiver	<p>According to clause 10.1.2 with the following specific processing:</p> <ul style="list-style-type: none"> • Checks the validity of the Request (e.g. format of Filter Criteria). • May change the filter criteria according to local policies. • Searches matched resources as per the DISCOVER privileges from the addressed resource hierarchy. • Limits the discovery result according to the upper limit on the size of the answer. <p>The Hosting CSE shall use the appropriate addressing (see clause 9.3.1) form for each element included in the list in accordance with the incoming request. If Filter Criteria is provided in the request, the Hosting CSE uses it identifying the resources whose attributes match the Filter Criteria. The Hosting CSE shall respond to the Originator with the appropriate list of discovered resources in the Hosting CSE.</p> <p>If the Filter Criteria includes <i>filterUsage</i> element set to "IPEOnDemandDiscovery", the target is the <AE> resource and the Hosting CSE has no match from the discovery of existing resources, then the Hosting CSE shall send a NOTIFY request containing the Filter Criteria to the AE (i.e. <i>pointOfAccess</i> of the <AE> resource) and the Originator ID of this discovery request. When the CSE gets the successful NOTIFY response with the resource address(es) which are created under the <AE> resource, then the CSE shall check the DISCOVER privilege and return the address(es) to the Originator. When the CSE gets the unsuccessful NOTIFY response, then the CSE shall send the Response Status Code in the NOTIFY response to the Originator.</p> <p>The Hosting CSE may modify the Filter Criteria including upper limit provided by the Originator or the discovery results based on the local policies.</p> <p>If the size of the result list is bigger than the upper limit or the scope of discoverable resources, according to the Originator's access control policy or service subscription has been modified by the Hosting CSE, the full list is not returned. Instead, an incomplete list is returned and an indication is added in the response for warning the requestor.</p>
Information in Response message	<p>All parameters defined in table 8.1.3-1 apply with the specific details for:</p> <ul style="list-style-type: none"> • Contains the address list of discovered resources expressed in any of the methods depicted in clause 9.3.1. The address list may be empty if no result matching the filter criterion is discovered. • Contains an incomplete list warning if the full list is not returned.
Processing at Originator after receiving Response	According to clause 10.1.2.
Exceptions	<p>According to clause 10.1.2, with the following:</p> <ul style="list-style-type: none"> • The request contains invalid parameters. • The on-demand discovery was rejected by the requested M2M Application.

10.2.7 Group Management Procedures

10.2.7.1 Introduction

This clause describes different procedures for managing membership verification, creation, retrieval, update and deletion of the information associated with a <group> resource. Bulk management of all group member resources by invoking the corresponding operations upon the virtual resource <fanOutPoint> of a <group> resource are detailed. This clause also describes the use of retrieve operations in conjunction with the virtual resource <semanticFanOutPoint>, for the purpose of semantic discovery.

10.2.7.2 Create <group>

This procedure shall be used for creating a <group> resource.

Table 10.2.7.2-1: <group> CREATE

<group> CREATE	
Associated Reference Point	Mcc, Mca and Mcc'
Information in Request message	<p>From: Identifier of the AE or the CSE that initiates the Request</p> <p>To: The address of the <CSEBase>, <AE>, or <remoteCSE> where the <group> resource is intended to be Created</p> <p>Content: The representation of the <group> resource for which the attributes are described in clause 9.6.13</p>
Processing at Originator before sending Request	The Originator shall request to Create a <group> resource by using the CREATE operation. The request shall address <CSEBase>, <remoteCSE> or <AE> resource of a Hosting CSE. The Request shall also provide <i>memberIDs</i> and may provide <i>expirationTime</i> attributes. For members which are of type <group>, the originator shall suffix the '/fopt' to that 'memberID' during group creation if the originator wants to fan-out the group request to each member of that sub-<group>, else originator shall not suffix the '/fopt' to that 'memberID'. The Originator may be an AE or a CSE
Processing at Receiver	<p>For the CREATE procedure, the Receiver shall:</p> <ul style="list-style-type: none"> • Check if the Originator has CREATE permissions on the target resource • Check the validity of the provided attributes • Validate that there are no duplicate members present in the <i>memberIDs</i> attribute • Validate that the resource type of every member on each member Hosting CSE conforms to the <i>memberType</i> attribute in the request, if the <i>memberType</i> attribute of the <group> resource is not 'mixed'. Set the <i>memberTypeValidated</i> attribute to TRUE upon successful validation • Upon successful validation of the provided attributes, create a new group resource in the Hosting CSE. If the CSE supports semantic discovery functionality, the Hosting CSE shall also create and set the <i>semanticSupportIndicator</i> attribute to TRUE. • Conditionally, in the case that the group resource contains temporarily unreachable Hosting CSE of sub-group resources as member resource, set the <i>memberTypeValidated</i> attribute of the <group> resource to FALSE • Respond to the Originator with the appropriate generic Response with the representation of the <group> resource if the <i>memberTypeValidated</i> attribute is FALSE, and the address of the created <group> resource if the CREATE was successful • As soon as any Hosting CSE that hosts the unreachable resource becomes reachable, the <i>memberType</i> validation procedure shall be performed. If the <i>memberType</i> validation fails, the Hosting CSE shall deal with the <group> resource according to the policy defined by the <i>consistencyStrategy</i> attribute of the <group> resource provided in the request. or by default if the attribute is not provided
Information in Response message	The representation of the <group> resource if the <i>memberTypeValidated</i> attribute is FALSE
Processing at Originator after receiving Response	None
Exceptions	No change from the basic procedure in clause 10.1.1

10.2.7.3 Retrieve <group>

This procedure shall be used for retrieving <group> resource.

Table 10.2.7.3-1: <group> RETRIEVE

<group> RETRIEVE	
Associated Reference Point	Mcc, Mca and Mcc'
Information in Request message	From: Identifier of the AE or the CSE that initiates the Request To: The address of the <group> resource
Processing at Originator before sending Request	The Originator shall request to obtain <group> resource information by using the RETRIEVE operation. The request shall address the specific <group> resource of a Hosting CSE. The Originator may be an AE or a CSE
Processing at Receiver	No change from the basic procedure in clause 10.1.2
Information in Response message	No change from the basic procedure in clause 10.1.2
Processing at Originator after receiving Response	None
Exceptions	No change from the basic procedure in clause 10.1.2

10.2.7.4 Update <group>

This procedure shall be used for updating an existing <group> resource.

Table 10.2.7.4-1: <group> UPDATE

<group> UPDATE	
Associated Reference Point	Mca, Mcc and Mcc'
Information in Request message	From: Identifier of the AE or the CSE that initiates the Request To: The address of the <group> resource
Processing at Originator before sending Request	The Originator shall request to update attributes of an existing <group> resource by using an UPDATE operation. The Request shall address the specific <group> resource of a CSE. If originator intends to update memberIDs attribute ,for members which are of type <group>, originator shall suffix the '/fopt' to that 'memberID' during group updation if the originator wants to fan-out the group request to each member of that sub-<group> ,else originator shall not suffix the '/fopt' to that 'memberID'. The Originator may be an AE or a CSE
Processing at Receiver	The UPDATE procedure shall be: <ul style="list-style-type: none"> • Check if the Originator has UPDATE permissions on the <group> resource • Check the validity of provided attributes • Validate that there are no duplicated members present in the <i>memberIDs</i> attribute • Validate that the resource type of every member on each member Hosting CSE conforms to the <i>memberType</i> attribute in the request, if the <i>memberType</i> attribute of the <group> resource is not 'mixed'. Set the <i>memberTypeValidated</i> attribute to TRUE upon successful validation • Upon successful validation of the provided attributes, update the <group> resource in the Hosting CSE • Conditionally, in the case that the <group> resource contains temporarily unreachable Hosting CSE of sub-group resources as members resource set the <i>memberTypeValidated</i> attribute of the <group> resource to FALSE • Respond to the Originator with the appropriate generic response with the representation of the <group> resource if the <i>memberTypeValidated</i> attribute is FALSE, and the address of the created <group> resource if the UPDATE is successful • As soon as any Hosting CSE that hosts unreachable resource becomes reachable, the <i>memberType</i> validation procedure shall be performed. If the <i>memberType</i> validation fails, the Hosting CSE shall deal with the <group> resource according to the policy defined by the <i>consistencyStrategy</i> attribute of the <group> resource provided in the request, or by default if the attribute is not provided
Information in Response message	The representation of the <group> resource if the <i>memberTypeValidated</i> attribute is FALSE
Processing at Originator after receiving Response	None
Exceptions	No change from the basic procedure in clause 10.1.3

10.2.7.5 Delete <group>

This procedure shall be used for deleting an existing <group> resource.

Table 10.2.7.5-1: <group> DELETE

<group> DELETE	
Associated Reference Point	Mcc, Mca and Mcc'
Information in Request message	From: Identifier of the AE or the CSE that initiates the Request To: The address of the <group> resource
Processing at Originator before sending Request	The Originator shall request to delete an existing <group> resource by using the DELETE operation. The request shall address the specific <group> resource of a Hosting CSE. The Originator may be an AE or a CSE This operation shall also delete the child virtual resources <fanOutPoint> and <semanticFanOutPoint>
Processing at Receiver	No change from the basic procedure in clause 10.1.4
Information in Response message	No change from the basic procedure in clause 10.1.4
Processing at Originator after receiving Response	None
Exceptions	No change from the basic procedure in clause 10.1.4

10.2.7.6 <fanOutPoint> Management Procedures

Figure 10.2.7.6-1 illustrates how the <fanOutPoint> virtual resource works on the group Hosting CSE. The procedures in the figure apply to clauses 10.2.7.6 to 10.2.7.9.

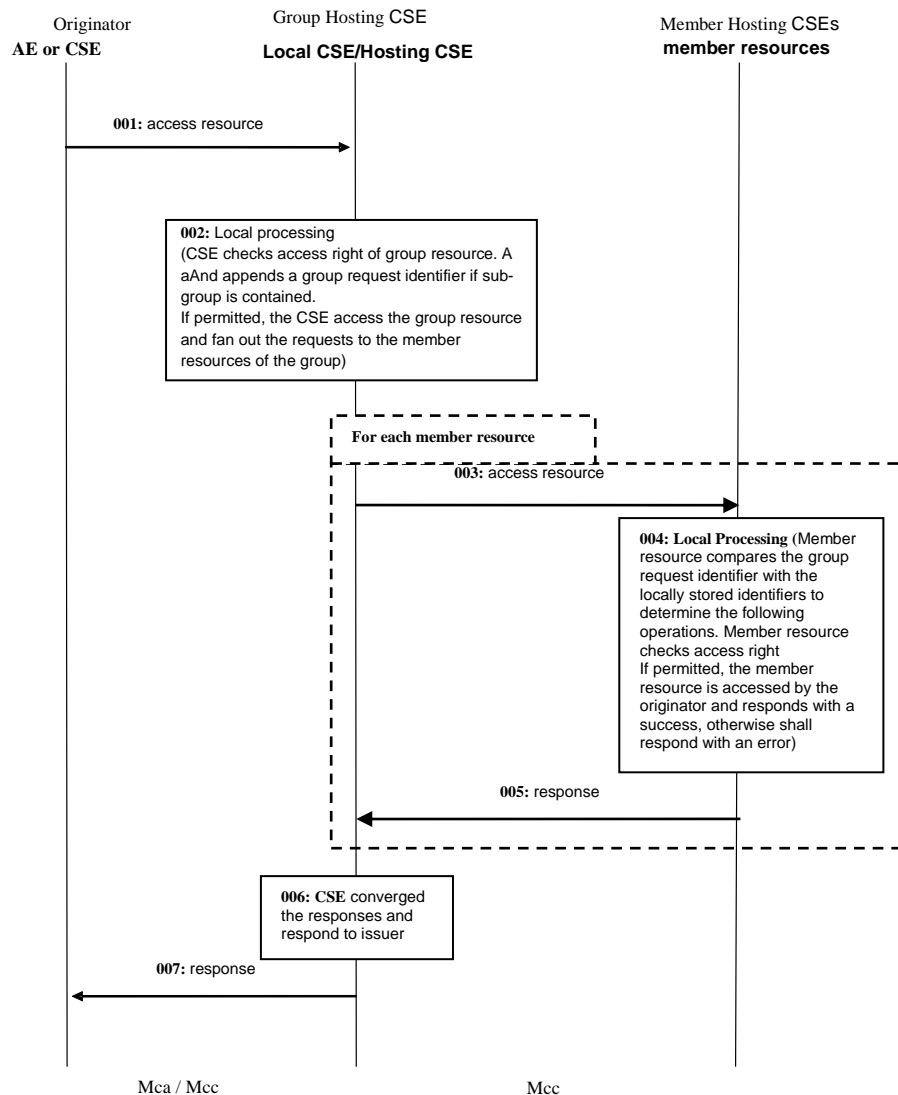

Figure 10.2.7.6-1: Group content management procedures

If the group resource, whose *fanOutPoint* virtual sub-resource is addressed by the request, contains <group> resources as member resources, when fanning out the request, the Group Hosting CSE shall address the *fanOutPoint* virtual sub-resource of the member <group> resource in step 3. So that the member <group> resource Hosting CSE could further fan out the request to its members correspondingly.

10.2.7.7 Create <fanOutPoint>

This procedure shall be used for creating the content of all members resources belonging to an existing <group> resource.

Table 10.2.7.7-1: <fanOutPoint> CREATE

<fanOutPoint> CREATE	
Associated Reference Point	Mca, Mcc and Mcc'
Information in Request message	<p>From: Identifier of the AE or the CSE that initiates the Request</p> <p>To: The address of the <fanOutPoint> virtual resource</p> <p>Content: The representation of the resource the Originator intends to create</p> <p>Group Request Identifier: The group request identifier</p> <p>Response Type: If the parameter is set to BlockingSynch, it indicates that the group hosting CSE shall return the aggregated response once. Otherwise if the parameter is set to nonBlockingRequestSynch, nonBlockingRequestAsynch or flexBlocking, it indicates that the Group Hosting CSE shall return the aggregated response in a batched mode</p> <p>Result Expiration Time: Indicates the maximum time limit in which the Group Hosting CSE has to respond the aggregated response</p>
Processing at Originator before sending Request	The Originator shall request to create the resource that have the same content in all members resources belonging to an existing <group> resource by using a CREATE operation. The Request may address the virtual child resource <fanOutPoint> of the specific <group> resource of a group Hosting CSE. The request may also address the address that results from appending a relative address to the <fanOutPoint> address in order to create the resources that have the same content under the corresponding child resources represented by the relative address with respect to all members resources. The Originator may be an AE or CSE

<fanOutPoint> CREATE	
Processing at Group Hosting CSE	<p>For the CREATE procedure, the Group Hosting CSE shall:</p> <ul style="list-style-type: none"> • Check if the Originator has CREATE privilege in the <accessControlPolicy> resource referenced by the <i>membersAccessControlPolicyIDs</i> in the <group> resource. In the case <i>membersAccessControlPolicyIDs</i> is not provided the access control policy defined for the <group> resource shall be used • Upon successful validation, obtain the IDs of all members resources from the attribute <i>membersIDs</i> of the addressed <group> resource • Generate fan out requests addressing the obtained address (appended with the relative address if any) to the member hosting CSEs as indicated in figure 10.2.7.6-1. The From parameter in the fanout request is set to ID of the Originator from the request from the original Originator. The Response Type parameter in the fanout request may be set by the group hosting CSE differently according to its local policy • In the case that a member resource is a <group> resource and the request to be fanned out does not contain a group request identifier already, generate a unique group request identifier, include the group request identifier in all the requests to be fanned out and locally store the group request identifier • If the group Hosting CSE determines that multiple members resources belong to one CSE according to the IDs of the members resources, it may converge the requests accordingly before sending out. This may be accomplished by the group Hosting CSE creating a <group> resource on the members Hosting CSE to collect all the members on that members Hosting CSE • After receiving the responses from the members hosting CSEs, respond to the Originator with the aggregated results and the associated members list. Depending on the Response Type, the Group Hosting CSE shall: <ul style="list-style-type: none"> - blockingRequest: respond with the aggregated responses before the Result Expiration Time reaches and discard the member responses received after - nonBlockingRequestSynch: prepare the <i>operationResult</i> of the <request> resource and indicate that if all the member responses have been aggregated by setting the <i>requestStatus</i> of the <request> resource before the Result Expiration Time reaches. There may be multiple updates of the <i>operationResult</i> attribute. - nonBlockingRequestAsynch: notify with the aggregated response from all or part of the members before the Result Expiration Time reaches. There may be more than one notifications. - flexBlocking: continue aggregate the member response until the group hosting CSE determines to send the aggregated responses, if all member responses has been aggregated, respond the aggregated response as in the blockingRequest case. Otherwise, respond an acknowledgement together with the current aggregated member responses and the reference to the created <request> resource. Then continue aggregate and deliver the remaining member response to the Originator as defined in the nonBlockingRequestSynch or the nonBlockingRequestAsynch case. - After the Result Expiration Time, there shall not be any further updates to the aggregated responses. <p>(See note)</p>
Processing at Member Hosting CSE	<p>For the CREATE procedure, the Member Hosting CSE shall:</p> <ul style="list-style-type: none"> • Check if the request has a group request identifier. Check if the group request identifier is contained in the requested identifiers stored locally. If match is found, ignore the current request and respond an error. If no match is found, locally store the group request identifier until the expiration of the request expiration time or local policy • Check if the original Originator has the CREATE permission on the addressed resource. Upon successful validation, perform the create procedures for the corresponding type of addressed resource as described in other sub-clauses of clause 10.2 • Send the corresponding response to the Group Hosting CSE
Information in Response message	Converged responses from members hosting CSEs
Processing at Originator after receiving Response	None

<fanOutPoint> CREATE	
Exceptions	<ul style="list-style-type: none"> • Same request with identical group request identifier received • Originator does not have the CREATE permission to access the <fanOutPoint> resource
NOTE: If Result Expiration Time is not provide in the original request from the Originator, the group hosting CSE may decide the timer based on its local policy.	

10.2.7.8 Retrieve <fanOutPoint>

This procedure shall be used for retrieving the content of all member resources belonging to an existing <group> resource.

Table 10.2.7.8-1: <fanOutPoint> RETRIEVE

<fanOutPoint> RETRIEVE	
Associated Reference Point	Mca, Mcc and Mcc'
Information in Request message	<p>From: Identifier of the AE or the CSE that initiates the Request</p> <p>To: The address of the <fanOutPoint> virtual resource</p> <p>Content: The representation of the resource the Originator intends to retrieve</p> <p>Group Request Identifier: The group request identifier</p> <p>Response Type: If the parameter is set to BlockingSynch, it indicates that the group hosting CSE shall return the aggregated response once. Otherwise if the parameter is set to nonBlockingRequestSynch or nonBlockingRequestAsynch, it indicates that the Group Hosting CSE shall return the aggregated response in a batched mode</p> <p>Result Expiration Time: Indicates the maximum time limit in which the Group Hosting CSE has to respond the aggregated response</p>
Processing at Originator before sending Request	The Originator shall request to obtain the resource or specific attributes of all member resources belonging to an existing <group> resource by using a RETRIEVE operation. The request may address the virtual child resource <fanOutPoint> of the specific <group> resource of a group Hosting CSE. The request may also address the address that results from appending a relative address to the <fanOutPoint> address in order to retrieve the corresponding attributes or child resources represented by the relative address with respect to all members resources. The Originator may be an AE or CSE
Processing at Group Hosting CSE	<p>For the RETRIEVE procedure, the Group Hosting CSE shall:</p> <ul style="list-style-type: none"> • Check if the Originator has RETRIEVE permission in the <accessControlPolicy> resource referenced by the membersAccessControlPolicyIDs in the addressed <group> resource. In the case membersAccessControlPolicyIDs is not provided, the access control policy defined for the group resource shall be used • Upon successful validation, obtain the IDs of all members resources from the membersIDs attribute of the addressed <group> resource • Generate fan out requests addressing the obtained address (appended with the relative address if any) to the members hosting CSEs as indicated in figure 10.2.7.6-1. The From parameter in the fanout request is set to ID of the Originator from the request from the original Originator. The Response Type parameter in the fanout request may be set by the group hosting CSE differently according to its local policy • In the case that a member resource is a <group> resource, generate a unique group request identifier and the request to be fanned out does not contain a group request identifier already, include the group request identifier in all the requests to be fanned out and locally store the group request identifier • If the group hosting CSE determines that multiple members resources belong to one CSE according to the IDs of the members resources, it may converge the requests accordingly before sending out. This may be accomplished by the group Hosting CSE creating a <group> resource on the members Hosting CSE to collect all the members on that members Hosting CSE • After receiving the responses from the members hosting CSEs, respond to the Originator with the aggregated results and the associated members list. Depending on the Response Type, the Group Hosting CSE shall: <ul style="list-style-type: none"> - BlockingRequest: respond with the aggregated responses before the Result Expiration Time reaches and discard the member responses received after.

	<ul style="list-style-type: none"> - nonBlockingRequestSynch: prepare the <i>operationResult</i> of the <request> resource and indicate that if all the member responses have been aggregated by setting the <i>requestStatus</i> of the <request> resource before the Result Expiration Time reaches. There may be multiple updates of the <i>operationResult</i> attribute. - nonBlockingRequestAsynch: notify with the aggregated response from all or part of the members before the Result Expiration Time reaches. There may be more than one notifications. - flexBlocking: continue aggregate the member response until the group hosting CSE determines to send the aggregated responses. If all member responses has been aggregated, respond the aggregated response as in the blockingRequest case. Otherwise, respond an acknowledgement together with the current aggregated member responses and the reference to the created <request> resource. Then continue aggregate and deliver the remaining member response to the Originator as defined in the nonBlockingRequestSynch or the nonBlockingRequestAsynch case. - After the Result Expiration Time, there shall not be any further updates to the aggregated responses. <p>(See note)</p>
Processing at Member Hosting CSE	<p>For the RETRIEVE procedure, the Member Hosting CSE shall:</p> <ul style="list-style-type: none"> • Check if the request has a group request identifier. Check if the group request identifier is contained in the requested identifier stored locally. If match is found, ignore the current request and respond an error. If no match is found, locally store the request identifier until the expiration of the request expiration time or local policy • Check if the original Originator has the RETRIEVE permission on the addressed resource. Upon successful validation, perform the retrieve procedures for the corresponding type of addressed resource as described in other sub-clauses of clause 10.2 • Send the corresponding response to the group Hosting CSE
Information in Response message	Converged responses from members hosting CSEs
Processing at Originator after receiving Response	None
Exceptions	<ul style="list-style-type: none"> • Same request with identical group request identifier received • Originator does not have RETRIEVE permission to access the <fanOutPoint> resource
NOTE:	If Result Expiration Time is not provide in the original request from the Originator, the group hosting CSE may decide the timer based on its local policy.

10.2.7.9 Update <fanOutPoint>

This procedure shall be used for updating the content of all member resources belonging to an existing <group> resource.

Table 10.2.7.9-1: <fanOutPoint> UPDATE

<fanOutPoint> UPDATE	
Associated Reference Point	Mca, Mcc and Mcc'
Information in Request message	<p>From: Identifier of the AE or the CSE that initiates the Request</p> <p>To: The address of the <group> resource</p> <p>Content: The representation of the resource the Originator intend to Update</p> <p>Group Request Identifier: The group request identifier</p> <p>Response Type: If the parameter is set to BlockingSynch, it indicates that the group hosting CSE shall return the aggregated response once. Otherwise if the parameter is set to nonBlockingRequestSynch or nonBlockingRequestAsynch, it indicates that the Group Hosting CSE shall return the aggregated response in a batched mode</p> <p>Result Expiration Time: Indicates the maximum time limit in which the Group Hosting CSE has to respond the aggregated response</p>

<fanOutPoint> UPDATE	
Processing at Originator before sending Request	The Originator shall request to update all member resources belonging to an existing <group> resource with the same data by using a UPDATE operation. The request may address the virtual child resource <fanOutPoint> of the specific <group> resource of a group Hosting CSE. The request may also address the address that results from appending a relative address to the <fanOutPoint> in order to update the corresponding child resources represented by the relative address with respect to all <members> resources. The Originator may be an AE or CSE
Processing at Group Hosting CSE	<p>For the UPDATE procedure, the Group Hosting CSE shall:</p> <ul style="list-style-type: none"> • Check if the Originator has UPDATE permission in the <accessControlPolicy> resource referenced by the membersAccessControlPolicyIDs in the group resource. In the case members membersAccessControlPolicyIDs is not provided the access control policy defined for the group resource shall be used • Upon successful validation, obtain the IDs of all member resources from the attribute membersIDs of the addressed <group> resource • Generate fan out requests addressing the obtained address (appended with the relative address if any) to the members hosting CSEs as indicated in figure10.2.7.6-1. The From parameter in the fanout request is set to ID of the Originator from the request from the original Originator. The Response Type parameter in the fanout request may be set by the group hosting CSE differently according to its local policy • In the case that a member resource is a <group> resource and the request to be fanned out does not contain a group request identifier already, generate a unique group request identifier, include it in all the requests to be fanned out and locally store the group request identifier • If the group Hosting CSE determines that multiple members resources belong to one CSE according to the IDs of the member resources, it may converge the requests accordingly before sending out. This may be accomplished by the group Hosting CSE creating a <group> resource on the member Hosting CSE to collect all the members on that members Hosting CSE • After receiving the responses from the members hosting CSEs, respond to the Originator with the aggregated results and the associated members list. Depending on the Response Type, the Group Hosting CSE shall: <ul style="list-style-type: none"> - BlockingRequest: respond with the aggregated responses before the Result Expiration Time reaches and discard the member responses received after - nonBlockingRequestSynch: prepare the <i>operationResult</i> of the <request> resource and indicate that if all the member responses have been aggregated by setting the <i>requestStatus</i> of the <request> resource before the Result Expiration Time reaches. There may be multiple updates of the <i>operationResult</i> attribute - nonBlockingRequestAsynch: notify with the aggregated response from all or part of the members before the Result Expiration Time reaches. There may be more than one notifications - flexBlocking: continue aggregate the member response until the group hosting CSE determines to send the aggregated responses, if all member responses has been aggregated, respond the aggregated response as in the blockingRequest case. Otherwise, respond an acknowledgement together with the current aggregated member responses and the reference to the created <request> resource. Then continue aggregate and deliver the remaining member response to the Originator defined in the nonBlockingRequestSynch or the nonBlockingRequestAsynch case - After the Result Expiration Time, there shall not be any further updates to the aggregated responses <p>(See note)</p>

<fanOutPoint> UPDATE	
Processing at Member Hosting CSE	For the UPDATE procedure, the Member Hosting CSE shall: <ul style="list-style-type: none"> • Check if the request has a group request identifier. Check if the request identifier is contained in the requested identifier stored locally. If match is found, ignore the current request and respond an error. If no match is found, locally store the request identifier until the expiration of the request expiration time or local policy • Check if the original Originator has the UPDATE permission on the addressed resource. Upon successful validation, perform the update procedures for the corresponding type of addressed resource as described in other sub-clauses of clause 10.2 • Send the corresponding response to the group Hosting CSE
Information in Response message	Converged responses from members hosting CSEs
Processing at Originator after receiving Response	None
Exceptions	<ul style="list-style-type: none"> • Same request with identical group request identifier received • Originator does not have the UPDATE permissions to access the <fanOutPoint> resource
NOTE: If Result Expiration Time is not provide in the original request from the Originator, the group hosting CSE may decide the timer based on its local policy.	

10.2.7.10 Delete <fanOutPoint>

This procedure shall be used for deleting the content of all members resources belonging to an existing <group> resource.

Table 10.2.7.10-1: <fanOutPoint> DELETE

<fanOutPoint> DELETE	
Associated Reference Point	Mca, Mcc and Mcc'
Information in Request message	<p>From: Identifier of the AE or the CSE that initiates the Request</p> <p>To: The address of the <fanOutPoint> virtual resource</p> <p>Content: The representation of the resource the Originator intends to delete</p> <p>Group Request Identifier: The group request identifier</p> <p>Response Type: If the parameter is set to BlockingSynch, it indicates that the group hosting CSE shall return the aggregated response once. Otherwise if the parameter is set to nonBlockingRequestSynch or nonBlockingRequestAsynch, it indicates that the Group Hosting CSE shall return the aggregated response in a batched mode</p> <p>Result Expiration Time: Indicates the maximum time limit in which the Group Hosting CSE has to respond the aggregated response</p>
Processing at Originator before sending Request	The Originator shall request to delete all members resources belonging to an existing <group> resource by using a DELETE operation. The request may address the virtual child resource <fanOutPoint> of the specific <group> resource of a group Hosting CSE. The request may also address the address that results from appending a relative address to the <fanOutPoint> in order to delete the corresponding child resources represented by the relative address with respect to all member resources. The Originator may be an AE or a CSE

<fanOutPoint> DELETE	
Processing at Group Hosting CSE	<p>For the DELETE procedure, the <group> Hosting CSE shall:</p> <ul style="list-style-type: none"> • Check if the Originator has DELETE permission in the <accessControlPolicy> resource referenced by the <i>membersAccessControlPolicyIDs</i> in the <group> resource. In the case <i>membersAccessControlPolicyIDs</i> is not provided the access control policy defined for the group resource shall be used • Upon successful validation, obtain the IDs of all member resources from the attribute <i>membersIDs</i> of the addressed <group> resource • Generate fan out requests addressing the obtained address (appended with the relative address if any) to the member hosting CSEs as indicated in figure 10.2.7.6-1. From parameter in the fanout request is set to ID of the Originator from the request from the original Originator. The Response Type parameter in the fanout request may be set by the group hosting CSE differently according to its local policy • In the case that the members resources is a <group> resource and the request to be fanned out does not contain a group request identifier already, generate a unique group request identifier, include the group request identifier in all the requests to be fanned out and locally store the group request identifier • If the <group> Hosting CSE determines that multiple members resources belong to one CSE according to the IDs of the members resources, it may converge the requests accordingly before sending out. This may be accomplished by the group Hosting CSE creating a <group> resource on the member Hosting CSE to collect all the members on that member Hosting CSE • After receiving the responses from the members hosting CSEs, respond to the Originator with the aggregated results and the associated members list. Depending on the Response Type, the Group Hosting CSE shall: <ul style="list-style-type: none"> - BlockingRequest: respond with the aggregated responses before the Result Expiration Time reaches and discard the member responses received after - nonBlockingRequestSynch: prepare the <i>operationResult</i> of the <request> resource and indicate that if all the member responses have been aggregated by setting the <i>requestStatus</i> of the <request> resource before the Result Expiration Time reaches. There may be multiple updates of the <i>operationResult</i> attribute. - nonBlockingRequestAsynch: notify with the aggregated response from all or part of the members before the Result Expiration Time reaches. There may be more than one notifications. - flexBlocking: continue aggregate the member response until the group hosting CSE determines to send the aggregated responses, if all member responses has been aggregated, respond the aggregated response as in the blockingRequest case. Otherwise, respond an acknowledgement together with the current aggregated member responses and the reference to the created <request> resource. Then continue aggregate and deliver the remaining member response to the Originator as defined in the nonBlockingRequestSynch or the nonBlockingRequestAsynch case - After the Result Expiration Time, there shall not be any further updates to the aggregated responses <p>(See note)</p>
Processing at Member Hosting CSE	<p>For the DELETE procedure, the Members Hosting CSE shall:</p> <ul style="list-style-type: none"> • Check if the request has a group request identifier. Check if the group request identifier is contained in the requested identifier stored locally. If match is found, ignore the current request and respond an error. If no match is found, locally store the group request identifier until the expiration of the request expiration time or local policy • Check if the original Originator has the DELETE permission on the addressed resource. Upon successful validation, perform the delete procedures for the corresponding type of addressed resource as described in other sub-clauses of clause 10.2 • Send the corresponding response to the Group Hosting CSE
Information in Response message	Converged responses from members hosting CSEs
Processing at Originator after receiving Response	None

<fanOutPoint> DELETE	
Exceptions	<ul style="list-style-type: none"> • Same request with identical group request identifier received • Originator does not have the DELETE permissions to access the <fanOutPoint> resource
NOTE: If Result Expiration Time is not provide in the original request from the Originator, the group hosting CSE may decide the timer based on its local policy.	

10.2.7.11 Subscribe and Un-Subscribe <fanOutPoint> of a group

This procedure shall be used for receiving information about modifications of all member resources belonging to an existing <group> resource.

Table 10.2.7.11-1: <fanOutPoint> Subscribe/Un-subscribe

<fanOutPoint> Subscribe/Un-subscribe	
Associated Reference Point	Mca, Mcc and Mcc'
Information in Request message	<p>From: Identifier of the AE or CSE that initiates the request</p> <p>To: The address of the <fanOutPoint> resource appended with the ID of the <subscription> resource to be created</p> <p>Group Request Identifier: The group request identifier</p>
Processing at Originator before sending Request	<p>The Originator shall request to create a subscription resource under all member resources belonging to an existing <group> resource by using a CREATE operation. The request may address the virtual child resource <fanOutPoint> of the specific <group> resource of a group Hosting CSE. The request may also address the address that results from appending a relative address to the <fanOutPoint> in order to create the corresponding subscription to the resource represented by the relative address with respect to all member resources. In both cases the targeted resource shall the parent of the newly created <subscription> resource(s). The request shall include <i>notificationForwardingURI</i> attribute if the Originator wants the group Hosting CSE to aggregate the notifications. The request shall include the required information and may include the optional information as described in subscription management clause 10.2.11. The Originator may be an AE or a CSE</p>
Processing at Group Hosting CSE	<p>The <group> Hosting CSE shall:</p> <ul style="list-style-type: none"> • Check if the Originator has CREATE privilege in the <accessControlPolicy> resource referenced by the <i>membersAccessControlPolicyIDs</i> in the group resource. In the case <i>membersAccessControlPolicyIDs</i> is not provided the access control policy defined for the group resource shall be used If the subscription resource in the request contains an <i>notificationForwardingURI</i> attribute, assign a URI to replace the <i>notificationURI</i> of the subscription resource which will be used to receive notifications from member hosting CSEs. The ID of the <group> resource shall be set to the <i>groupID</i> attribute of the <subscription> resource. The group Hosting CSE shall maintain the mapping of the generated <i>notificationURI</i> and the former <i>notificationURI</i> • Upon successful validation, obtain the IDs of all member resources from the attribute <i>membersIDs</i> of the addressed <group> resource Generate fan out requests addressing the obtained address (appended with the relative address if any) to the member hosting CSEs as indicated in figure 10.2.7.6-1. From parameter in the request is set to ID of the Originator from the request from the original Originator • If the group Hosting CSE determines that multiple members resources belong to one CSE according to the IDs of the member resources, it may converge the requests accordingly before sending out. This may be accomplished by the <group> Hosting CSE creating a <group> resource on the members Hosting CSE to collect all the members on that members Hosting CSE • After receiving the responses from the member hosting CSEs, respond to the Originator with the aggregated results and the associated members list

<fanOutPoint> Subscribe/Un-subscribe	
Processing at Member Hosting CSE	<p>For the subscribe/un-subscribe procedure, the Members Hosting CSE shall treat the request received from the group Hosting CSE as a normal SUBSCRIBE request on the addressed member resource as if it comes from the original Originator. Therefore the members Hosting CSE shall:</p> <ul style="list-style-type: none"> • Check if the request has a group request identifier. Check if the group request identifier is contained in the requested identifier stored locally. If match is found, ignore the current request and respond an error. If no match is found, locally store the group request identifier until the expiration of the request expiration time or local policy • Check if the original Originator has the READ permission on the members resource • Upon successful validation, perform the subscribe procedures for the corresponding type of member resource as described in clause 10.2.12 • Send the corresponding response to the group Hosting CSE
Information in Response message	Converged responses from member hosting CSEs
Processing at Originator after receiving Response	None
Exceptions	<ul style="list-style-type: none"> • Same request with identical request identifier received • Originator does not have the access control privilege to access the <fanOutPoint> resource

Un-subscribing to the members of a <group> resource uses the "Delete <fanOutPoint>" procedure defined in clause 10.2.7.10.

An typical example of how the subscription is established is as follows. The Originator is creating subscription resource on Member-1 resource, Member-2 resource and Member-3 resource. Member-2 resource and Member-3 resource are members of Group-2 resource. Member-1 resource and Group-2 resource are members of Group-1 resource. In this case, Group-2 resource is the sub-group of Group-1 resource.

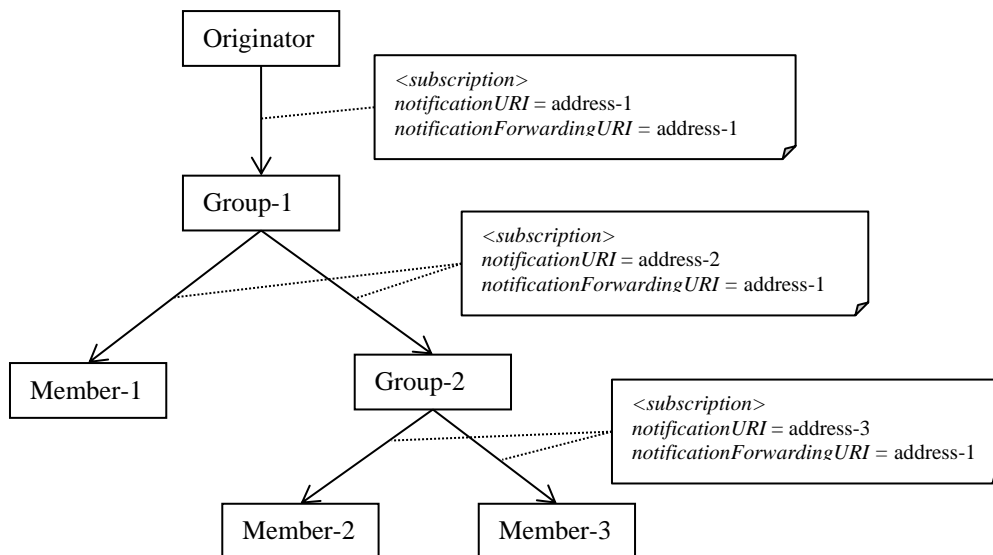

Figure 10.2.7.11-1: Example of subscription through group

Originator sends the <subscription> resource creation request to <fanOutPoint> of Group-1 resource. The Originator intends the Group-1 Hosting CSE to aggregate the notifications, thus, the Originator sets the notificationForwardingURI identical with notificationURI which is address-1 which is the address where the notification is supposed to be sent.

On receiving the request, the Group-1 Hosting CSE fans out the <subscription> creation request to address Member-1 resource and <fanOutPoint> resource of Group-2 resource. As *notificationForwardingURI* is set by the Originator, the Group-1 Hosting CSE allocates address-2 to receive aggregated notifications and put address-2 in the *notificationURI* of <subscription> resource to be fanned out.

On receiving the request, the Group-2 Hosting CSE fans out the <subscription> creation request to address Member-2 resource and Member-3 resource. As *notificationForwardingURI* is set, the Group-2 Hosting CSE allocates address-3 to receive aggregated notifications and put address-3 in the *notificationURI* of <subscription> resource to be fanned out. The mapping between address-2 and address-3 is maintained by the Group-2 Hosting CSE.

On receiving the request by any of the Member Hosting CSE, <subscription> resource is created.

10.2.7.12 Aggregate the Notifications by group

This procedure shall be used for the group Hosting CSE to aggregate the notifications from member hosting CSEs and forward the aggregated notification to the subscriber.

Table 10.2.7.12-1: Aggregation of Notifications by group

Aggregate Notifications by group	
Associated Reference Point	Mca, Mcc and Mcc'
Information in Request message	The same as table 10.2.12-1
Processing at Originator before sending Request (Member Hosting CSE)	Whenever the resource that is subscribed-to is modified in a way that matches the policies as is specified in clause 9.6.8, notification needs to be sent to the subscriber, the Members Hosting CSE shall: <ul style="list-style-type: none"> Notify the subscriber at the notificationURI and include the <i>notificationForwardingURI</i> in the notification, if it exists
Processing at Group Hosting CSE	For the notification procedure, the Group Hosting CSE shall: <ul style="list-style-type: none"> On receiving the notifications from the member hosting CSEs at the notificationURI generated by the group Hosting CSE during fanning out the <subscription> creation request, validate if the notification is sent from its member resource and contain a <i>notificationForwardingURI</i> attribute Upon successful validation, aggregate the notifications which have the same <i>notificationForwardingURI</i> for the duration specified in <i>notifyAggregation</i> or until the number of notifications specified in <i>notifyAggregation</i> are received, which ever occurs first. Send the aggregated notification to the subscriber according to the <i>notificationForwardingURI</i> in the notification. In the case the addressed group is the member of another group through which the subscription is created the notification shall be sent to the notificationURI assigned by the group hosting CSE which contains the addressed group as the sub-group according to the mapping of the <i>notificationURI</i> maintained by the addressed group. Wait for the response. After receiving the response, split the response and respond to the members hosting CSEs separately The group Hosting CSE may stop aggregating the notifications when the expirationTime of the corresponding subscription expires
Processing at Member Hosting CSE	The subscriber shall treat every notification extracted from the aggregated notification as a separate notification received from the subscribed resource and generate corresponding responses. The subscriber shall aggregate the responses to these notifications and send the aggregated response to the group Hosting CSE
Information in Response message	According to clause 10.1.5
Processing at Originator after receiving Response	According to clause 10.1.5
Exceptions	According to clause 10.1.5

The example of aggregating notification following example in clause 10.2.7.11 is as follows.

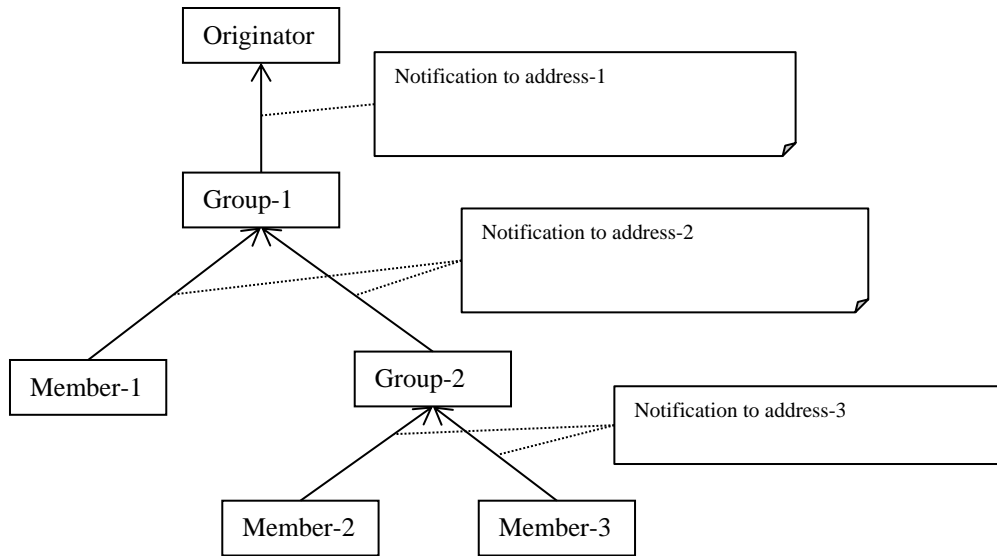

Figure 10.2.7.12-1: Example of aggregating notifications

Member Hosting CSEs send notifications to their corresponding Group Hosting CSEs. In this example, Member-2 Hosting CSE and Member-3 Hosting CSE send notifications to address-3 which is the address allocated by the Group-2 Hosting CSE. Member-1 Hosting CSE sends notifications to address-2 which is the address allocated by the Group-1 Hosting CSE.

On receiving notifications by the Group-2 Hosting CSE at address-3, Group-2 Hosting CSE aggregates the notification that has *notificationForwardingURI* as address-1, as Group-2 Hosting CSE maintains the mapping of address-3 and address-2, and sends the aggregated notification to address-2.

On receiving notifications by the Group-1 Hosting CSE at address-2, Group-1 Hosting CSE aggregates the notification that has *notificationForwardingURI* as address-1, as Group-1 Hosting CSE receives *<subscription>* resource with *notificationURI* address-1, Group-1 Hosting CSE send the aggregated notification to address-1.

10.2.7.13 *<semanticFanOutPoint>* Procedures

The virtual resource *<semanticFanOutPoint>* is used for processing semantic discovery requests. As such, this virtual resource shall be the target of RETRIEVE requests only. The *<semanticFanOutPoint>* resource is created and deleted at the same time with the parent *<group>* resource.

10.2.7.14 Retrieve *<semanticFanOutPoint>*

This procedure shall be used for performing a semantic discovery procedure using the descriptor content of all member *<semanticDescriptor>* resources belonging to an existing *<group>* resource.

Table 10.2.7.14-1: <semanticFanOutPoint> RETRIEVE

<semanticFanOutPoint> RETRIEVE	
Associated Reference Point	Mca, Mcc and Mcc'
Information in Request message	According to clause 10.1.2
Processing at Originator before sending Request	The Originator shall request a semantic discovery to be performed using the content of the semantic descriptors of all member resources belonging to an existing <group> resource. The Originator may be an AE or CSE
Processing at Receiver	<p>The Receiver shall:</p> <ul style="list-style-type: none"> • Check if the Originator has RETRIEVE privilege in the <accessControlPolicy> resource referenced by the <i>membersAccessControlPolicyIDs</i> in the parent <group> resource. In the case <i>membersAccessControlPolicyIDs</i> is not provided, the access control policy defined for the parent <group> resource shall be used • Upon successful validation, obtain the URIs of all the member <semanticDescriptor> resources from the <i>memberIDs</i> attribute of the parent <group> resource • If there are <semanticDescriptor> resources stored on different CSEs, individual RETRIEVE requests are sent to each CSE for retrieving the descriptors, otherwise the <i>descriptor</i> attributes are simply retrieved for all the <semanticDescriptor> resources hosted locally. All semantic descriptors are accessed based on the respective access control policies • Once all of the related <i>descriptor</i> attributes have been retrieved, the SPARQL request is being executed on the combined content
Information in Response message	The result of the SPARQL request executed on the combined content of the members' <i>descriptors</i>
Processing at Originator after receiving Response	According to clause 10.1.2
Exceptions	According to clause 10.1.2

10.2.8 <mgmtObj> Resource Procedures

10.2.8.1 Introduction

This clause describes the management procedures over Mca and Mcc reference points. If technology specific protocols are used for management, different operations addressing a <mgmtObj> resource (or its attributes or child resources) shall be translated by IN-CSE into technology specific requests performed on the mapped technology specific data model object on the managed entity. In this case, the <mgmtObj> resources are hosted on the IN-CSE. Although management requests by the AE are agnostic to the technology specific protocol, the <mgmtObj> resource exposes information about the technology specific protocol. AEs have the capability to retrieve this information within the *objectIDs* attribute of the <mgmtObj> resource.

In the scenario where the <mgmtObj> resource does not utilize an external management technology but instead uses the M2M Service Layer to perform the management request, the <mgmtObj> resource is hosted on the CSE of the managed entity when the managed entity is an ASN, MN or IN. If the managed entity is an ADN node or the managed entity is co-located on an ASN, MN or IN, the <mgmtObj> resource is hosted on the registrar CSE of the managed entity. The <mgmtObj> resource and its parent <node> resource hosted on node's CSE may be announced to associated IN-CSEs.

In the scenario where the managed entity is an NoDN, the managed entities' <mgmtObj> resources are hosted by the CSE of the node to which the managed entity is attached.

10.2.8.2 Create <mgmtObj>

This procedure shall be used to create a specific <mgmtObj> resource in the Hosting CSE to expose the corresponding management function of a managed entity (i.e. M2M Device/Gateway) over the Mca reference point. Depending on the data model being used, the created <mgmtObj> resource may be a partial or complete mapping from the technology specific data model object on the managed entity. If such an technology specific data model object is missing from the managed entity, it shall be added to the managed entity. Further operations performed on the created <mgmtObj> resource shall be converted by the Hosting CSE into a corresponding technology specific request performed on the mapped technology specific data model object on the managed entity using technology specific protocol (e.g. OMA-DM [i.3] or BBF TR-069 [i.2]).

Besides the generic create procedure defined in clause 10.1.1.1, the procedure in the following table shall be used when management is performed using technology specific protocols.

If the management is performed by service layer entities, the procedure is the same as generic create procedure defined in clause 10.1.1.1. In this case, local APIs (drivers) on the managed entity is required to monitor the change of the <mgmtObj> resource and reflect the change to the managed entity.

Table 10.2.8.2-1: <mgmtObj> CREATE

<mgmtObj> CREATE	
Associated Reference Point	Mcc and Mca
Information in Request message	<p>From: Identifier of the AE or the CSE that initiates the Request</p> <p>To: The address of the <node> where the <mgmtObj> resource is intended to be Created</p> <p>Content: The representation of the <mgmtObj> resource for which the attributes are described in clause 9.6.15</p>
Processing at Originator before sending Request	<p>The Originator shall be an IN-AE, or a CSE which the managed entity is associated with:</p> <ul style="list-style-type: none"> • The Originator is a CSE: In this case, the CSE first collects the original technology specific data model object (the management tree structure or also the value of the tree nodes if needed) of the local device and transforms the object into the <mgmtObj> resource representation, then requests the Hosting CSE to create the corresponding <mgmtObj> resource. • The Originator is an AE: In this case, the AE requests the Hosting CSE to add the corresponding technology specific data model object to the managed entity by creating an <mgmtObj> resource in the Hosting CSE <p>(See notes 1 and 2)</p>
Processing at Receiver	<p>For the CREATE operation, besides the common create operation defined in clause 10.1.1, the Receiver shall:</p> <ul style="list-style-type: none"> • If the Originator is an AE: Check if there is existing management session between the management server and the managed entity. If not, request the management server to establish a management session towards the managed entity. Send the technology specific request to the managed entity or to the management server to add the corresponding technology specific data model object to the managed entity based on technology specific protocol • Maintain the mapping relationship between the created <mgmtObj> resource and the technology specific data model object on the managed entity • Respond to the Originator with the appropriate responses based on the technology specific response . It shall also provide in the response the address of the created new resource
Information in Response message	Error code if the new technology specific data model object is not created
Processing at Originator after receiving Response	None
Exceptions	<ul style="list-style-type: none"> • The creation of the technology specific data model object is not allowed • The created technology specific data model object already exists • Corresponding technology specific data model object cannot be added to the managed entity for some reason (e.g. not reachable, memory shortage)
<p>NOTE 1: The IN-CSE can create the <mgmtObj> resource locally by itself. The details are out of scope. In this case, the Hosting CSE first collects the original technology specific data model object on the managed entity via technology specific protocol (e.g. OMA DM [i.3], BBF TR-069 [i.2] or LWM2M [i.4]), then transforms the object into the <mgmtObj> resource representation and create the <mgmtObj> resource locally in the IN-CSE.</p> <p>NOTE 2: The <mgmtObj> resource can be created in the Hosting CSE by other offline provisioning means which are out of scope.</p>	

10.2.8.3 Retrieve <mgmtObj>

This procedure shall be used to retrieve information from an existing <mgmtObj> resource. Besides the generic retrieve procedure defined in clause 10.1.2, the procedure in the following table shall be used when management is performed using technology specific protocols. If the management is performed by service layer entities, the procedure is the same as generic retrieve procedure defined in 10.1.2.

Table 10.2.8.3-1: <mgmtObj> RETRIEVE

<mgmtObj> RETRIEVE	
Associated Reference Point	Mcc and Mca
Information in Request message	From: Identifier of the AE or the CSE that initiates the Request To: The address of the <mgmtObj> resource
Processing at Originator before sending Request	The Originator shall be an AE, or a CSE which the managed entity is associated with
Processing at Receiver	For the RETRIEVE operation, besides the common retrieve operation defined in clause 10.1.2, the Receiver shall: <ul style="list-style-type: none"> If the Originator is an AE and if the requested information of the <mgmtObj> resource is not available, identify the corresponding technology specific data object on the managed entity according to the mapping relationship that the IN-CSE maintains. Check if there is an existing management session between the management server and the managed entity. If not, request the management server to establish a management session towards the managed entity. Send the technology specific request to get the corresponding technology specific data model object from the managed entity based on the external management technology, then return the result to the Originator based on the technology specific response
Information in Response message	Error code if the new technology specific data model object cannot be retrieved
Processing at Originator after receiving Response	None
Exceptions	<ul style="list-style-type: none"> Corresponding technology specific data model object data cannot be retrieved from the managed entity (e.g. technology specific data model object not found)

10.2.8.4 Update <mgmtObj>

This procedure shall be used to update information of an existing <mgmtObj> resource. Besides the generic update procedure defined in clause 10.1.3, the procedure in the following table shall be used when management is performed using technology specific protocol. If the management is performed by service layer entities, the procedure is the same as generic update procedure defined in clause 10.1.3. In this case, local APIs (drivers) on the managed entity is required to monitor the change of the <mgmtObj> resource and reflect the change to the managed entity.

Table 10.2.8.4-1: <mgmtObj> UPDATE

<mgmtObj> UPDATE	
Associated Reference Point	Mcc and Mca
Information in Request message	From: Identifier of the AE or the CSE that initiates the Request To: The address of the <mgmtObj> resource Content: The representation of the <mgmtObj> resource for which the attributes are described in clause 9.6.15
Processing at Originator before sending Request	The Originator shall be an IN-AE, or a CSE which the on a managed entity is associated with
Processing at Receiver	For the UPDATE operation, besides the common update operation defined in clause 10.1.3, the Receiver shall: <ul style="list-style-type: none"> • If the Originator is an IN-AE, identify the corresponding technology specific data model object on the managed entity according to the mapping relationship it maintains. Check if there is an existing management session between the management server and the managed entity. If not, request the management server to establish a management session towards the managed entity. Send the technology specific request to update the corresponding technology specific data model object in the managed entity accordingly based on technology specific protocol • Respond to the Originator with the appropriate response based on the technology specific response from the external management technology
Information in Response message	Error code if the technology specific data model object cannot be updated
Processing at Originator after receiving Response	None
Exceptions	<ul style="list-style-type: none"> • Corresponding technology specific data model object cannot be updated to managed entity (e.g. not reachable, technology specific data model object not found)

10.2.8.5 Delete <mgmtObj>

This procedure shall be used to delete an existing <mgmtObj> resource. An IN-AE uses this procedure to remove the corresponding technology specific data model object (e.g. an obsolete software package) from the managed entity. Besides the generic delete procedure defined in clause 10.1.4, the procedure in the following table shall be used when management is performed using external management technologies. If the management is performed by service layer entities, the procedure is the same as generic delete procedure defined in clause 10.1.4. In this case, local APIs (drivers) on the managed entity is required to monitor the change of the <mgmtObj> resource and reflect the change to the managed entity.

Table 10.2.8.5-1: <mgmtObj> DELETE

<mgmtObj> DELETE	
Associated Reference Point	Mcc and Mca
Information in Request message	From: Identifier of the IN-AE, or the CSE that initiates the Request To: The address of the <mgmtObj> resource
Processing at Originator before sending Request	The Originator shall be an IN-AE or CSE which the managed entity is associated with: <ul style="list-style-type: none"> • The Originator is a CSE: In this case, the CSE issues the request to the Hosting CSE to hide the corresponding management function from being exposed by the <mgmtObj> resource • The Originator is an IN-AE: In this case, the IN-AE requests the Hosting CSE to delete the <mgmtObj> resource from the Hosting CSE and to remove the corresponding technology specific data model object from the managed entity (See notes 1 and 2)
Processing at Receiver	For the DELETE operation, besides the common create operation defined in clause 10.1.4, the Receiver shall: <ul style="list-style-type: none"> • If the Originator is an IN-AE, identify the corresponding technology specific data model object on the managed entity according to the mapping relationship IN-CSE maintains. Check if there is an existing management session between the management server and the managed entity. If not, request the management server to establish a management session towards the managed entity. The IN-CSE sends technology specific request to remove the corresponding technology specific data model object from the managed entity based on technology specific protocol • Respond to the Originator with the appropriate generic responses based on the technology specific response
Information in Response message	Error code if the technology specific data model object cannot be deleted
Processing at Originator after receiving Response	None
Exceptions	<ul style="list-style-type: none"> • Corresponding technology specific data model object cannot be deleted from managed entity (e.g. not reachable, technology specific data model object not found)
<p>NOTE 1: The Hosting IN-CSE can delete the <mgmtObj> resource locally by itself. This internal procedure is out of scope.</p> <p>NOTE 2: The <mgmtObj> resource can be deleted in the Hosting CSE by offline provisioning means which are out of scope.</p>	

10.2.8.6 Execute <mgmtObj>

This procedure shall be used to execute a technology specific requests on a managed entity through an existing <mgmtObj> resource on the Hosting CSE.

Table 10.2.8.6-1: <mgmtObj> EXECUTE

<mgmtObj> EXECUTE	
Associated Reference Point	Mcc and Mca
Information in Request message	From: Identifier of the IN-AE, or the CSE that initiates the Request To: The address of the <mgmtObj> resource
Processing at Originator before sending Request	The Originator shall be an IN-AE. The Originator shall request to execute a management command which is represented by a <mgmtObj> resource or its attribute by using an UPDATE operation The request shall address the executable <mgmtObj> resource. For an execute operation on an attribute(s), the Content parameter shall be included with the name of such attribute(s) with predefined value(s) to trigger the respective action After the execution request, the Originator shall request to retrieve the execution result or status from the executable <mgmtObj> resource or its attribute/child resource by using a RETRIEVE operation as specified in clause 10.2.7.3
Processing at Receiver	For the EXECUTE operation , the Receiver shall: <ul style="list-style-type: none"> • Check if the Originator has the WRITE privilege on the addressed <mgmtObj> resource or its attribute • Check if there is an existing management session between the management server and the managed entity. If not, request the management server to establish a management session towards the managed entity. Send the technology specific request to execute the corresponding management command (e.g. "Exec" in OMA DM [i.3]) on the managed entity based on technology specific protocol • Respond to the Originator with the appropriate response based on the technology specific response. If available, the technology specific response shall contain execution results • Retrieve the execution result or status from the executable <mgmtObj> resource or its attribute, perform the procedures as described in clause 10.2.8.3 • Upon receiving a management notification (e.g. OMA-DM [i.3] "Generic Alert" message or BBF TR-069 [i.2] "Inform" message) from a managed entity regarding the execution result or status, the Receiver shall send the technology specific request to retrieve the execution result or status of the technology specific data model object information received from the managed entity and update the corresponding <mgmtObj> resource or its attribute
Information in Response message	Error code if the technology specific request cannot be executed
Processing at Originator after receiving Response	None
Exceptions	<ul style="list-style-type: none"> • Corresponding technology specific request cannot be executed in managed entity (e.g. not reachable, technology specific data model object not found)

10.2.9 External Management Operations through <mgmtCmd>

10.2.9.1 Introduction

This clause describes how RESTful management operations may be performed using <mgmtCmd> resources over the Mca and Mcc reference points. The <mgmtCmd> resource, together with its attributes or sub-resources, may be used in the process of translating between RESTful operations and management commands and procedures from existing management technologies (e.g. BBF TR-069 [i.2]). These procedures can then be performed on the managed entity, using the Management Adapter and the procedures described in the following clauses.

10.2.9.2 Create <mgmtCmd>

A CREATE request shall be used by an Originator to create a specific <mgmtCmd> resource in a Hosting CSE.

The created <mgmtCmd> resource will be mapping a RESTful method to management commands and/or procedures which may be translated from existing management protocols (e.g. BBF TR-069 [i.2]). At run-time the Hosting CSE can expose the translated commands, over the Mcc reference point, to the managed entities (i.e. ASN/MN-CSE).

The Originator may be:

- An AE registered to the IN-CSE.
- The CSE on the managed entity: In this case, the CSE transforms supported management command into the <mgmtCmd> resource representation, then requests the Hosting CSE to create the corresponding <mgmtCmd> resource.

NOTE 1: The Hosting IN-CSE in the network domain may also create the <mgmtCmd> resource locally by itself. The details are out of scope. Then an AE can discover the created <mgmtCmd> and manipulate it.

NOTE 2: The <mgmtCmd> resource could also be created in the Hosting CSE by other offline provisioning means which are out of scope.

The Receiver shall be an IN-CSE.

Table 10.2.9.2-1: <mgmtCmd> CREATE

<mgmtCmd> CREATE	
Associated reference point	Mcc and Mca
Information in Request message	The attributes of the <mgmtCmd> resource. The mandatory and/or optional attributes defined in clause 9.6.16, as needed
Processing at Originator before sending Request	According to clause 10.1.1 with the following: <ul style="list-style-type: none"> • The CSE on the originating node shall first collect local management command
Processing at the Receiver	According to clause 10.1.1 with the following: <ul style="list-style-type: none"> • The Receiver CSE shall maintain the mapping between the created <mgmtCmd> resource and the corresponding nonRESTful commands represented by the <i>cmdType</i> attribute of <mgmtCmd> resource
Information in Response message	According to clause 10.1.1 with the following specific information: <ul style="list-style-type: none"> • Content: Address of created <mgmtCmd> resource
Processing at Originator after receiving Response	According to clause 10.1.1
Exceptions	According to clause 10.1.1

10.2.9.3 Retrieve <mgmtCmd>

This procedure shall be used for retrieving all or part information from a previously created <mgmtCmd> resource on a target CSE.

The Originator may be:

- An AE.
- A CSE.

The Receiver shall be an IN-CSE.

Table 10.2.9.3-1: <mgmtCmd> RETRIEVE

<mgmtCmd> RETRIEVE	
Associated reference point	Mcc and Mca
Information in Request message	According to clause 10.1.2, with the mandatory and/or optional attributes defined in clause 9.6.16, as needed
Processing at Originator before sending Request	According to clause 10.1.2
Processing at Receiver	According to clause 10.1.2
Information in Response message	According to clause 10.1.2
Processing at Originator after receiving Response	According to clause 10.1.2
Exceptions	According to clause 10.1.2

10.2.9.4 Update <mgmtCmd>

This procedure shall be used for updating some of the attributes (other than *execEnable*) of an existing <mgmtCmd> resource with new attribute values. An UPDATE method applied to the *execEnable* attribute is used to trigger the execution of the management procedure represented by <mgmtCmd>, as described in clause 10.2.9.6.

The Originator may be:

- An AE.
- A CSE.

The Receiver shall be an IN-CSE.

Table 10.2.9.4-1: <mgmtCmd> UPDATE

<mgmtCmd> UPDATE	
Associated reference point	Mcc and Mca
Information in Request message	According to clause 10.1.3, including mandatory and/or optional attributes defined in clause 9.6.16, as needed
Processing at Originator before sending Request	According to clause 10.1.3
Processing at Receiver	According to clause 10.1.3
Information in Response message	According to clause 10.1.3
Processing at the Originator after receiving Response	According to clause 10.1.3
Exceptions	According to clause 10.1.3

10.2.9.5 Delete <mgmtCmd>

This procedure shall be used for deletion of an existing <mgmtCmd> resource on a Hosting CSE. An AE may also use this procedure to cancel any initiated <execInstance> of an <mgmtCmd> if applicable.

The Originator may be:

- The CSE on the manageable entity: In this case, the CSE issues the request to the Hosting CSE to hide the corresponding management command from being exposed by the <mgmtCmd> resource.
- An AE: In this case, the AE requests the Hosting CSE to delete the <mgmtCmd> resource from the Hosting CSE and cancel all initiated <execInstance> of an <mgmtCmd> if applicable.

NOTE 1: The Hosting CSE in the network domain could also delete an <mgmtCmd> resource locally by itself. This internal procedure is out of scope.

NOTE 2: The <mgmtCmd> resource could also be deleted in the Hosting CSE by other offline provisioning means which are out of scope.

If the Originator is an AE and there is any initiated *<execInstance>* under the *<mgmtCmd>* that can be cancelled by a corresponding management command. The Hosting CSE shall also issue the management command to the managed entity to cancel those initiated *<execInstance>* based on existing management protocol (i.e. BBF TR-069 [i.2]). Then the CSE shall respond to the Originator with the appropriate generic responses.

The Receiver shall be an IN-CSE.

Table 10.2.9.5-1: *<mgmtCmd>* DELETE by ASN-CSE or MN-CSE

<i><mgmtCmd></i> DELETE by ASN-CSE or MN-CSE	
Associated reference point	Mcc
Information in Request message	According to clause 10.1.4
Processing at Originator before sending Request	According to clause 10.1.4 with the following: <ul style="list-style-type: none"> Before issuing a DELETE request to the IN-CSE, the originating CSE may perform cancelling of the corresponding management command locally
Processing at Receiver	According to clause 10.1.4 with the following: <ul style="list-style-type: none"> The Receiver IN-CSE shall verify if there are any initiated <i><execInstance></i> commands under the <i><mgmtCmd></i> which are cancellable by using a corresponding management command. If there are, the Receiver IN-CSE shall issue the management command to the managed entity to cancel those initiated <i><execInstance></i> based on existing management protocol (i.e. BBF TR-069 [i.2]) The <i><mgmtCmd></i> resource shall be deleted from the repository of the Receiver IN-CSE Then the Receiver IN-CSE shall respond to the Originator ASN-CSE or MN-CSE with the appropriate responses
Information in Response message	According to clause 10.1.4
Processing at Originator after receiving Response	According to clause 10.1.4
Exceptions	According to clause 10.1.4 with the following: <ul style="list-style-type: none"> If the deletion is not allowed or the specific <i><mgmtCmd></i> resource does not exist, there is no local processing in the Receiver IN-CSE and a proper error code shall be returned to the Originator ASN-CSE or MN-CSE If the corresponding initiated commands cannot be deleted from the managed entity due to some reason (e.g. not found) a response with the proper indication shall be returned to the Originator ASN-CSE or MN-CSE

Table 10.2.9.5-2: <mgmtCmd> DELETE by an AE

<mgmtCmd> DELETE by an AE	
Associated Reference Points	Mca
Information in Request message	According to clause 10.1.4
Processing at the Originator before sending Request	According to clause 10.1.4
Processing at Receiver	According to clause 10.1.4 with the following: <ul style="list-style-type: none"> If there is any initiated <execInstance> under <mgmtCmd> and it is cancellable, the Receiver IN-CSE shall cancel those initiated <execInstance> from the managed entity using corresponding management procedures in existing management protocol (i.e. CancelTransfer RPC in BBF TR-069 [i.2]) The <mgmtCmd> resource shall be deleted from the repository of the Receiver IN-CSE
Information in Response message	According to clause 10.1.4
Processing at Originator after receiving Response	According to clause 10.1.4
Exceptions	According to clause 10.1.4 with the following: <ul style="list-style-type: none"> If the deletion is not allowed or the specific <mgmtCmd> resource does not exist, there is no local processing in the Receiver IN-CSE and a proper error code shall be returned to the Originator AE If the corresponding initiated commands cannot be deleted from managed entity due to some reason (e.g. not found) a response with the proper indication shall be returned to the Originator AE

10.2.9.6 Execute <mgmtCmd>

The Execute procedure shall be used by an Originator in order to trigger execution of a specific management command on a managed entity, by employing an UPDATE method to the *execEnable* attribute of an existing <mgmtCmd> resource on the Hosting CSE.

The Originator shall be an AE.

The Receiver shall be an IN-CSE.

Table 10.2.9.6-1: <mgmtCmd> EXECUTE

<mgmtCmd> EXECUTE	
Associated reference Points	Mca
Information in Request message	According to clause 10.1.3, with the following (see attributes defined in clause 9.6.16): <ul style="list-style-type: none"> The UPDATE request shall address the <i>execEnable</i> attribute with a predefined value to trigger the EXECUTE action
Processing at the Originator before sending Request	According to clause 10.1.3, with the following: After issuing the execution request, the Originator may request to retrieve the execution result or status from <execInstance> sub-resources of the <mgmtCmd> by using a RETRIEVE method as described in clause 10.2.9.3
Processing at the Receiver	According to clause 10.1.3 with the following: <ul style="list-style-type: none"> The Receiver shall check if the Originator has the UPDATE privilege on the addressed <mgmtCmd> resource. Upon successful validation, the Hosting CSE shall perform command conversion and mapping, and send the converted management command to execute with the provided arguments on the remote entity based on existing device management protocol (i.e. BBF TR 069 [i.2]) Then the Hosting CSE shall create for each target a corresponding <execInstance> resource under <mgmtCmd> and shall respond to the Originator with the appropriate generic responses. It shall also provide in the response the URL of the created <execInstance> resource If the <i>execTarget</i> attribute of the addressed <mgmtCmd> addresses a group, the Hosting CSE shall create corresponding <execInstance> resources for each target in the group and provide the corresponding URLs in the response <p>Upon receiving from any remote entity a management notification (i.e. BBF TR-069 [i.2] "Inform" message) regarding the execution result or status, the Hosting CSE may update the corresponding <execInstance> sub-resource locally</p>
Information in Response message	According to clause 10.1.3
Processing at Originator after receiving Response	According to clause 10.1.3, with additional processing which is dependent on the type of the command and execution status. The following actions may occur in any order after the command execution is finished: <ul style="list-style-type: none"> The managed entity may send responses including execution results to the Receiver CSE, who will store the execution results in corresponding <execInstance> resource The Originator AE may use normal RETRIEVE procedure to retrieve the execution results or status of an <execInstance>. After receiving a RETRIEVE request from the Originator AE, the Receiver CSE can retrieve the execution status or results on the managed entity using existing management protocol A response shall be returned to the Originator AE
Exceptions	<ul style="list-style-type: none"> If the execution is not allowed or the specified <mgmtCmd> resource does not exist, no further processing is required on the Receiver CSE, and a proper error code shall be returned to the Originator AE in the message response If the corresponding management command cannot be executed on the managed entity, an error code shall be returned with the response to Originator AE

10.2.9.7 Cancel <execInstance>

The Cancel procedure shall be used by an originating AE to disable/stop/cancel an initiated management command execution on the remote entity, through an UPDATE method to the *execDisable* attribute of an existing <execInstance> resource on the Hosting CSE.

The Originator shall be an AE.

The Receiver shall be an IN-CSE.

Table 10.2.9.7-1: <execInstance> CANCEL

<execInstance> CANCEL	
Associated reference Points	Mca
Information in Request message	According to clause 10.1.3, with the following (see attributes defined in clause 9.6.17): The UPDATE request shall address the <i>execDisable</i> attribute with a predefined value in order to trigger the CANCEL action
Processing at the Originator before sending Request	Originator needs to disable/stop/cancel an initiated management command execution on the managed entity using an <execInstance> sub-resource at the Receiver, by using an UPDATE operation See also clause 10.1.3
Processing at Receiver	The Receiver shall check if the Originator has the UPDATE privilege on the addressed <execInstance> resource Then, the Receiver shall check if the management operation is initiated and cancellable. Upon successful validation, the Receiver IN-CSE shall perform command conversion and mapping, then use existing management protocol (i.e. BBF TR-069 [i.2]) to cancel the corresponding management command execution initiated on the managed entity The Receiver IN-CSE shall respond to the Originator with the appropriate responses
Information in Response message	According to clause 10.1.3
Processing at Originator after receiving ResponsePost-	According to clause 10.1.3
Exceptions	<ul style="list-style-type: none"> If the <execInstance> has not been initiated, is already complete or it is not cancellable, or the specified <execInstance> resource does not exist in the Receiver IN-CSE, the post processing on Receiver CSE shall be skipped and a proper error code shall be returned to Originator in the Response message

10.2.9.8 Retrieve <execInstance>

This procedure shall be used for retrieving all or part information from an <execInstance> resource on a target CSE.

The Originator shall be an AE.

The Receiver shall be an IN-CSE.

Table 10.2.9.8-1: <execInstance> RETRIEVE

<execInstance> RETRIEVE	
Associated Reference Points	Mca
Information in Request message	According to clause 10.1.2, with the mandatory and/or optional attributes defined in clause 9.6.17, as needed
Processing at the Originator before sending Request	Originator needs to create a resource
Processing at Receiver	According to clause 10.1.2, with the following: <ul style="list-style-type: none"> If the retrieval is allowed, the Receiver IN-CSE can retrieve the execution status or results on the managed entity using existing management protocol (i.e. BBF TR-069 [i.2]) If the retrieval is allowed, the addressed attributes of the <execInstance> resource shall be retrieved from the repository of the Receiver IN-CSE
Information in Response message	According to clause 10.1.2
Processing at Originator after receiving Response	According to clause 10.1.2
Exceptions	If the retrieval is not allowed or the specific <execInstance> resource does not exist in the Receiver IN-CSE, there is no local processing on the Receiver CSE and a proper error code shall be returned to Originator AE in the Response Message

10.2.9.9 Delete <execInstance>

The DELETE request procedure shall be used by an originating AE to delete an existing <execInstance> resource on a Receiver IN-CSE.

The Originator shall be an AE.

NOTE 1: The Receiver IN-CSE in the network domain could also delete an <execInstance> resource locally by itself. This internal procedure is out of scope.

NOTE 2: The <execInstance> resource could also be deleted in the Receiver IN-CSE by other offline provisioning means which are out of scope.

Receiver: The Receiver shall check if the Originator has the DELETE permission on the addressed <execInstance> resource. Upon successful validation, the Hosting CSE shall remove the resource from its repository. If a corresponding management command has been initiated and is pending finished on the managed entity and the management command is cancellable, the Hosting CSE shall use existing management protocols (i.e. BBF TR-069 [i.2] CancelTransfer RPC) to cancel the corresponding management currently initiated at the managed entity. Then the CSE shall respond to the Originator with the appropriate generic responses.

The Hosting CSE shall be an IN-CSE.

Table 10.2.9.9-1: <execInstance> DELETE

<execInstance> DELETE	
Associated Reference Point	Mca
Information in Request message	According to clause 10.1.4
Processing at the Originator before sending Request	According to clause 10.1.4
Processing at Receiver	<p>According to clause 10.1.4 with the following:</p> <ul style="list-style-type: none"> • If the <execInstance> has not been initiated, is already complete or it is not cancellable, the <execInstance> resource shall be deleted from the repository of the IN-CSE • If the <execInstance> is pending and it is cancellable, the Receiver IN-CSE shall first cancel the <execInstance> from the managed entity using corresponding management procedures in existing management protocol (i.e. CancelTransfer RPC in BBF TR-069 [i.2]). Afterwards, the <execInstance> resource shall be deleted from the repository of the Receiver IN-CSE. If the corresponding initiated commands cannot be successfully cancelled on the managed entity for some reason, the <execInstance> resource shall be still deleted <p>Then the Receiver IN-CSE shall respond to the Originator with the appropriate generic responses</p>
Information in Response message	According to clause 10.1.4
Processing at Originator after receiving Response	According to clause 10.1.4
Exceptions	If the deletion is not allowed or the specific <execInstance> resource does not exist on the Receiver IN-CSE, there is no processing at the Receiver and a proper error code shall be returned to the Originator

10.2.10 Location Management Procedures

10.2.10.1 Procedure related to <locationPolicy> resource

10.2.10.1.0 Overview

This clause introduces the procedures for obtaining and managing a target M2M Node's location information, which are associated with the <locationPolicy> resource that contains the method for obtaining and managing location information.

10.2.10.1.1 Create <locationPolicy>

This procedure shall be used for creating a <locationPolicy> resource.

Table 10.2.10.1.1-1: <locationPolicy> CREATE

<locationPolicy> CREATE	
Associated Reference Point	Mca, Mcc and Mcc'
Information in Request message	<p>From: Identifier of the AE or the CSE that initiates the Request</p> <p>To: the address of the <CSEBase> resource</p> <p>Content: The representation of the <locationPolicy> resource described in clause 9.6.10</p>
Processing at Originator before sending Request	According to clause 10.1.1.1
Processing at Receiver	<ul style="list-style-type: none"> • Check whether the Originator is authorized to request the procedure • Check whether the provided attributes of the <locationPolicy> resource represent a valid Request • Upon successful validation of the above procedures, the Hosting CSE creates <container> resource and a <locationPolicy> resource. Both of these resources shall be hosted locally on the Hosting CSE. The Hosting CSE shall maintain cross-reference between both resources: <i>locationContainerID</i> attribute for <locationPolicy> resource and <i>locationID</i> attribute for <container> resource • Check the defined <i>locationSource</i> attribute to determine which method is used. The <i>locationSource</i> attribute shall be set based on the capabilities of a target M2M Node, the required location accuracy of the Originator and the Underlying Network in which a target M2M Node resides: <ul style="list-style-type: none"> - For the Network-based case, if the <i>locationServer</i> is absent in the Originator's request the Hosting CSE shall either derive the <i>locationServer</i> value from the <i>locationTargetID</i> or be pre-provisioned with the identity of a locationServer. The Hosting CSE shall transform the request from the Originator into a Location Server request that includes the following attributes <i>locationTargetID</i>, <i>locationServer</i> that are defined in the <locationPolicy> resource. Additionally, the Hosting CSE shall also provide default values for other parameters (e.g. required quality of position) in the Location Server request [i.5] according to local policies. If the request which requests the location information of the target device towards the Location Server crosses over the Mcn reference point, then the Location Server in the Underlying Network performs positioning procedures, and returns the results over the Mcn reference point - The specific mechanism used to communicate with the network Location Server depends on the capabilities of the Underlying Network and other factors. For example, it could be either the OMA Mobile Location Protocol [i.5] or OMA RESTful NetAPI for Terminal Location [i.6] <p>Check the assigned <i>locationInformationType</i> attribute and if the value of this attribute is <i>Geo-fence event</i>, following the steps below:</p> <p>The Hosting CSE shall check the target Node's capability (Positionable, Non-Positionable or both) by retrieving the stored <node> resource or <mgmtCmd> procedure (e.g. checking the Node's capability through RPC-based procedure) and the Hosting CSE shall create <mgmtCmd></p>

<locationPolicy> CREATE	
	<p>resource type with appropriate configuration based on the node capability and attributes stored in the created <locationPolicy> resource (e.g. locationUpdatePeriod attribute of <locationPolicy> to execFrequency attribute of <mgmtCmd>) to obtain the Geo-fence relevant information (e.g. measurement or position fix) from the target Node. The node shall respond the information and the Hosting CSE shall create <execInstance> resource type as a placeholder for the information. The Hosting CSE shall forward this information to Geo-Fence Server (refer to locationServer attribute) and returns the results (e.g. event type) over the <i>Mcn</i> reference point. The result shall be stored in the created <container> resource as explained in clause 10.2.10.2.1.</p> <p>(See note)</p> <ul style="list-style-type: none"> - For the Device-based case, this case is applicable if the Originator is ASN-AE and the ASN has location determination capabilities (e.g. GPS). The Hosting CSE is capable of performing positioning procedure using the module or technologies. For example, if the ASN has a GPS module itself, the ASN-CSE obtains the location information of Node from the GPS module through internal interfaces (e.g. System call or JNI [i.18]). The detail procedure is out-of-scope - For the Sharing-based case, this case shall be applicable if the Originator is an ADN-AE and the Hosting CSE is MN CSE and the ADN is a resource constrained node, no location determination capabilities (e.g. GPS) and Network-based positioning capabilities. Also according to the required location accuracy of the AE, the Originator may choose this case <p>When the Hosting CSE receives the CREATE request and if the Hosting CSE can find the closest Node that is registered with the Hosting CSE and has location information from the Originator in the M2M Area Network, the location information of the closest Node shall be stored as the location information of the Originator, or if the Hosting CSE cannot find any closest Node or has no topology information, the location information of the Node of the Hosting CSE (MN) shall be stored as the location information of the Originator. The closest Node can be determined by the minimum hop based on the topology information stored in the <node> resource.</p>
Information in Response message	The representation of the created <locationPolicy> resource
Processing at Originator after receiving Response	According to clause 10.1.1.1
Exceptions	No change from the generic procedure
NOTE: The details of the mechanisms are addressed in the oneM2M TS-0004 [3].	

10.2.10.1.2 Retrieve <locationPolicy>

This procedure shall be used for retrieving an existing <locationPolicy> resource.

Originator: The Originator shall request to obtain <locationPolicy> resource information by using RETRIEVE operation. The Originator is either an AE or a CSE.

Receiver: The Receiver shall check if the Originator has RETRIEVE permission on the <locationPolicy> resource. Upon successful validation, the Hosting CSE shall respond to the Originator with the appropriate responses.

Table 10.2.10.1.2-1: <locationPolicy> RETRIEVE

<locationPolicy> RETRIEVE	
Associated Reference Point	Mca, Mcc and Mcc'
Information in Request message	From: Identifier of the AE or the CSE that initiates the Request To: The address of the target <locationPolicy> resource
Processing at Originator before sending Request	None
Processing at Receiver	According to clause 10.1.2
Information in Response message	According to clause 10.1.2
Processing at Originator after receiving Response	None
Exceptions	According to clause 10.1.2

10.2.10.1.3 Update <locationPolicy>

This procedure shall be used for updating an existing <locationPolicy> resource.

Originator: The Originator shall request to update attributes of an existing <locationPolicy> resource by using an UPDATE operation. The request shall address the specific <locationPolicy> resource of a CSE. The Originator may be either an AE or a CSE.

Receiver: The Receiver of an UPDATE request shall check whether the Originator is authorized to request the operation. The receiver shall further check whether the provided attributes of the <locationPolicy> resource represent a valid request for updating <locationPolicy> resource.

Table 10.2.10.1.3-1: <locationPolicy> UPDATE

<locationPolicy> UPDATE	
Associated Reference Point	Mca, Mcc and Mcc'
Information in Request message	From: Identifier of the AE or the CSE that initiates the Request To: The address of the target <locationPolicy> resource Content: The attributes which are to be updated
Processing at Originator before sending Request	None
Processing at Receiver	According to clause 10.1.3 with the following: <ul style="list-style-type: none"> If the value of <i>locationUpdatePeriod</i> attribute is updated to 0 or NULL, the Hosting CSE shall stop periodical positioning procedure and perform the procedure when Originator retrieves the <latest> resource of the linked <container> resource. See clause 10.2.10.2 for more detail If the value of <i>locationUpdatePeriod</i> attribute is updated to bigger than 0 (e.g. 1 hour) from 0 or NULL, the Hosting CSE shall start periodical positioning procedure
Information in Response message	According to clause 10.1.3
Processing at Originator after receiving Response	None
Exceptions	According to clause 10.1.3

10.2.10.1.4 Delete <locationPolicy>

This procedure shall be used for deleting an existing <locationPolicy> resource.

Originator: The Originator shall request to delete an existing <locationPolicy> resource by using the DELETE operation. The Originator may be either an AE or a CSE. This request can be occurred when the *locationSource* attribute of the created <locationPolicy> resource is "sharing-based" and the Originator is an AE that disconnects from the registered MN-CSE.

Receiver: The Receiver shall check if the Originator has DELETE permission on the <locationPolicy> resource. Upon successful validation, the CSE shall remove the resource from its repository and shall respond to the Originator with appropriate responses.

Table 10.2.10.1.4-1: <locationPolicy> DELETE

<locationPolicy> DELETE	
Associated Reference Point	Mca, Mcc and Mcc'
Information in Request message	From: Identifier of the AE or the CSE that initiates the Request To: the address of the target <locationPolicy> resource
Processing at Originator before Sending Request	None
Processing at Receiver	According to clause 10.1.4
Information in Response message	According to clause 10.1.4
Processing at Originator after receiving Response	Once the <locationPolicy> resource is deleted, the Receiver shall delete the associated resources (i.e. <container>, <contentInstance> resources). If the <i>locationSource</i> attribute and the <i>locationUpdatePeriod</i> attribute of the <locationPolicy> resource has been set with appropriate value, the Receiver shall tear down the session. The specific mechanism used to tear down the session depends on the support of the Underlying Network and other factors
Exceptions	According to clause 10.1.4

10.2.10.2 Procedure when the <container> and <contentInstance> resource contain location information

10.2.10.2.0 Overview

Since the actual location information of a target M2M Node shall be stored in the <contentInstance> resource as per the configuration described in the associated <locationPolicy> resource, this clause introduces the procedures related to the <contentInstance> and <container> resource.

10.2.10.2.1 Procedure for <container> resource that stores the location information

This procedure is mainly triggered by the creation of <locationPolicy> resource. Based on the defined attributes related to the <container> resource such as 'locationContainerID' and 'locationContainerName', the Hosting CSE shall create <container> resource to store the location information in its child resource, <contentInstance> resource after the CSE obtains the actual location information of a target M2M Node. If the Originator provides the 'locationContainerName' and the given 'locationContainerName' does not exist in the Hosting CSE, the Hosting CSE shall set the 'resourceName' of the created <container> resource to the 'locationContainerName' provided by the Originator. If the given 'locationContainerName' already exists in the Hosting CSE, the Hosting CSE shall respond with an error following the general exceptions written in clause 10.1.1.1. If the Originator does not provide the 'locationContainerName' the Hosting CSE shall provide 'resourceName' for the created <container> resource. After the creation of the <container> resource, the *resourceID* attribute of the resource shall be stored in the 'locationContainerID'.

10.2.10.2.2 Procedure for <contentInstance> resource that stores location information

After the <container> resource that stores the location information is created, each instance of location information shall be stored in the different <contentInstance> resources. In order to store the location information in the <contentInstance> resource, the Hosting CSE firstly checks the defined *locationUpdatePeriod* attribute. If a valid period value is set for this attribute, the Hosting CSE shall perform the positioning procedures as defined period value, *locationUpdatePeriod*, in the associated <locationPolicy> resource and stores the results (e.g. position fix and uncertainty) in the <contentInstance> resource under the created <container> resource. However, if no value (e.g. null or zero) is set, the positioning procedure shall be performed when an Originator requests to retrieve the <latest> resource of the <container> resource and the result shall be stored as a <contentInstance> resource under the <container> resource.

10.2.11 <subscription> Resource Procedures

10.2.11.1 Introduction

An Originator may create a <subscription> resource on a subscribed-to resource Hosting CSE to be notified when the resource is modified. After successful <subscription> resource creation, the Hosting CSE shall notify the Originator of a subscribed-to resource modification that meets conditions configured in the <subscription> resource.

A subscription shall be represented by a <subscription> resource (see clause 9.6.8). This allows manipulation of the subscription in a resource oriented manner, e.g. the conditions of a subscription may be modified by modifying a <subscription> resource, or a resource subscriber may unsubscribe by deleting the <subscription> resource.

The following clauses describe procedures for Creation, Retrieval, Update and Deletion of a <subscription> resource.

10.2.11.2 Create <subscription>

This procedure shall be used to request the creation of a new <subscription> resource to be notified for the modifications of a subscribed-to resource. The generic create procedure is described in clause 10.1.1.1.

Table 10.2.11.2-1: <subscription> CREATE

<subscription> CREATE	
Associated Reference Point	Mca, Mcc and Mcc'
Information in Request message	All parameters defined in table 8.1.2-3 apply with the specific details for: Content: The resource content shall provide the information as defined in clause 9.6.8
Processing at Originator before sending Request	According to clause 10.1.1.1 with the following additions: The Request shall address a subscribable resource The Request shall include <i>notificationURI(s)</i> If the request includes <i>notificationURI(s)</i> which is not the Originator, the Originator should send the request as non-blocking request (see clauses 8.2.2 and 9.6.12)
Processing at Receiver	According to clause 10.1.1.1 with the following Which is also the Hosting CSE shall validate the followings: <ul style="list-style-type: none"> • Check if the subscribed-to resource, addressed in the To parameter in the Request, is a subscribable resource • Check if the Originator has privileges for retrieving the subscribed-to resource • If a notificationURI is not the Originator, the Hosting CSE may send a Notify request to the <i>notificationURI</i> to verify this <subscription> creation request. If the Hosting CSE initiates the verification, it shall check if the verification result in the Notify response is successful or not. If any <i>notificationURI</i> contained in a list fails verification then the <subscription> create process fails If any of the checks above fails, the Hosting CSE shall send an unsuccessful response to the Originator with corresponding error information. Otherwise, the Hosting CSE shall create the <subscription> resource and send a successful response to the Originator
Information in Response message	All parameters defined in table 8.1.3-1 apply with the specific details for: Content: address of the created <subscription> resource, according to clause 10.1.1.1
Processing at Originator after receiving Response	According to clause 10.1.1.1
Exceptions	According to clause 10.1.1.1

10.2.11.3 Retrieve <subscription>

This procedure shall be used to retrieve attributes and child resource information of a <subscription> resource. The generic retrieve procedure is described in clause 10.1.2.

Table 10.2.11.3-1: <subscription> RETRIEVE

<subscription> RETRIEVE	
Associated Reference Point	Mca, Mcc and Mcc'
Information in Request message	All parameters defined in table 8.1.2-3 apply with the specific details for: Content: void
Processing at Originator before sending Request	According to clause 10.1.2
Processing at Receiver	According to clause 10.1.2
Information in Response message	All parameters defined in table 8.1.3-1 apply with the specific details for: Content: attributes of the <subscription> resource as defined in clause 9.6.8
Processing at Originator after receiving Response	According to clause 10.1.2
Exceptions	According to clause 10.1.2

10.2.11.4 Update <subscription>

This procedure shall be used to update an existing subscription, e.g. extension of its lifetime or the modification of the list of *notificationURI(s)*. The generic update procedure is described in clause 10.1.3.

Table 10.2.11.4-1: <subscription> UPDATE

<subscription> UPDATE	
Associated Reference Point	Mca, Mcc and Mcc'
Information in Request message	All parameters defined in table 8.1.2-3 apply with the specific details for: Content: attributes of the <subscription> resource as defined in clause 9.6.8 which need be updated
Processing at Originator before sending Request	According to clause 10.1.3
Processing at Receiver	According to clause 10.1.3 <ul style="list-style-type: none"> • If a <i>notificationURI</i> is not the Originator, see table 10.2.11.2-1 in clause 10.2.11.2 • If the <i>latestNotify</i> attribute is set, the Hosting CSE shall assign Event Category parameter of value 'latest' of the notifications generated pertaining to the subscription created
Information in Response message	According to clause 10.1.3
Processing at Originator after receiving Response	According to clause 10.1.3
Exceptions	According to clause 10.1.3

10.2.11.5 Delete <subscription>

This procedure shall be used to unsubscribe an existing subscription. The generic delete procedure is described in clause 10.1.4.1.

Table 10.2.11.5-1: <subscription> DELETE

<subscription> DELETE	
Associated Reference Point	Mca, Mcc and Mcc'
Information in Request message	All parameters defined in table 8.1.2-3 apply
Processing at Originator before sending Request	According to clause 10.1.4.1
Processing at Receiver	According to clause 10.1.4.1
Information in Response message	According to clause 10.1.4.1
Processing at Originator after receiving Response	According to clause 10.1.4.1
Exceptions	According to clause 10.1.4.1

10.2.12 Notification Procedures for Resource Subscription

10.2.12.0 Overview

This procedure shall be used to notify Notification Targets of modifications of a resource for an associated <subscription> resource and notify the <subscription> resource deletion. Also, this procedure shall be used to request resource subscription verification to Notification Target which is not the Originator.

When the notification is forwarded or aggregated by transit CSEs, the Hosting CSE or a transit CSE shall check whether there is a *latestNotify* notification policy to enforce between subscription resource Hosting CSE and the notification target. In that case, the transit CSE as well as the Hosting CSE shall process notification(s) by using the corresponding policy and send processed notification(s) to the next CSE with notification policies related to the enforcement so that the transit CSE is able to enforce the policy defined by the Originator. The notification policies related to the enforcement at this time is verified by using the subscription reference in the Notify request message. If any transit CSE doesn't recognize the attribute, then it should ignore it.

10.2.12.1 Procedure for Originator of Notifications and Hosting CSEs

When a Hosting CSE receives a <subscription> creation request which requires verification (see clause 10.2.11.2), the Hosting CSE may send a notification to perform subscription verification. In this case, the notification shall include the ID of the Originator of the <subscription> resource creation.

When there is an event for a <subscription> resource, the <subscription> Hosting CSE shall include in the notification the *creator* if the <subscription> resource has creator attribute.

Further details of Hosting CSE related notification policies follow:

The *expirationCounter* shall be decreased by one when the Hosting CSE successfully sends the notification request to Receiver(s). If the counter reaches zero, the corresponding subscription resource shall be deleted.

In the case an Originator wants to create batches of notifications rather than have the Hosting CSE send notifications one by one, it may set the *batchNotify* attribute to express its notification policy. The *batchNotify* attribute (notification policy) is based on two values, the number of notifications to be batched for delivery, and/or a duration. When the Hosting CSE generates a notification event it checks the *batchNotify* policy, if a duration value is specified then a timer is started which expires after the duration value. If a number of notifications is specified then notification events are accumulated until the accumulated notification events reaches the specified number. If only the duration is specified, then the accumulated notifications are sent as a batch when the timer expires. If both values are set then accumulated notifications are sent as a batch when either the timer expires or the number is reached whichever happens first. If neither the number nor the duration is specified (i.e. the *batchNotify* attribute is present and empty), then the Hosting CSE shall batch notifications using the default duration value as given by the M2M Service Provider. Note that Hosting CSE shall not batch notifications when the *batchNotify* is not present in the <subscription> resource. When the first notification event is generated then a timer shall be started and keep batching notifications for the duration. After the duration, batched notification shall be sent and a timer shall be set again at the next notification event. For example, a *batchNotify* policy having a duration of 10 minutes and a number of 20 notifications will accumulate notifications which is sent when the first of these two conditions are satisfied. The sending order is first-in first out (FIFO). The batch

timer shall be reset once the batched notifications are being sent. *notificationEventCat* is checked at the time of batch transmission and applied to each notification individually in the batch. Stored notification events may be dropped according to the *notificationStoragePriority* and the *notificationCongestionPolicy* (see clause 9.6.3). When the *batchNotify* and *latestNotify* attributes (notification policies) are used together, they enable two ways of sampling notification events for notification generation. If the number of notification is set high then the duration value will drive the policy, and the *latestNotify* policy will cause a single event notification every duration period, e.g. send the latest event notification every hour. If the duration value is set high then the number of notifications will drive the policy, and the *latestNotify* policy will cause a single notification for every specified number of notifications, e.g. send the latest event notification for every 500 events notifications generated. The scope of the *batchNotify* policy is the Hosting CSE for the one subscription it is set in, and does not extend to transit CSEs.

In the case when an Originator wants to limit the rate at which notifications are sent, it may set the *rateLimit* attribute (notification policy) to express its notification policy. The *rateLimit* policy is based on two values, a maximum specified number of events (e.g. 10,000) that may be sent within some specified *rateLimit* window duration (e.g. 60 seconds), and the *rateLimit* window duration. When the Hosting CSE generates a notification event it checks the *rateLimit* policy and whether the current total number of events sent is less than the maximum number of events within the current *rateLimit* window duration. If the current total is less than the maximum number then the notification may be sent. If it is equal or more then the notification is temporarily stored until the end of the current window duration, when the sending of notification events restarts in the next window duration. The sending of notification events continues as long as the maximum number of notification events is not exceeded within the window duration. The *rateLimit* windows are sequential (not rolling). The *rateLimit* policy may be used simultaneously with *batchNotify* and *notificationStoragePriority* policies. The scope of the *rateLimit* policy is the Hosting CSE for the one subscription it is set in, and does not extend to transit CSEs.

The *pendingNotification* attribute (notification policy) indicates the notification procedure to be followed following a connectionless period (due to lack of notification schedule or reachability schedule). When the Hosting CSE generates a notification with the *pendingNotification*, it shall check the notification schedule of the subscription and the reachability schedule associated with the Notification Target. If there is no restriction then the notification is immediately sent, otherwise the notification may be cached according to the *pendingNotification*. If caching of retained notifications is supported on the Hosting CSE and contains the subscribed events then pending notification (those that occurred during the connectionless period) will be sent to Notification Target per the *pendingNotification* policy. If it is set to the "sendLatest", most recent notification should be sent and it shall have the *Event Category* set to "latest". Figure 10.2.12.1-1 illustrates an example for this case. If it is set to "sendAllPending", all the missed cached notifications should be sent in the order they occurred. Figure 10.2.12.1-2 illustrates an example of this case. The Hosting CSE may use the *pendingNotification* policy to determine whether and how many interim notifications to retain in its cache. The *pendingNotification* policy may be used simultaneously with any other notification policy, which would impact what would be sent during the connection period. The scope of the *pendingNotification* is the Hosting CSE for the one subscription it is set in, and does not extend to transit CSEs.

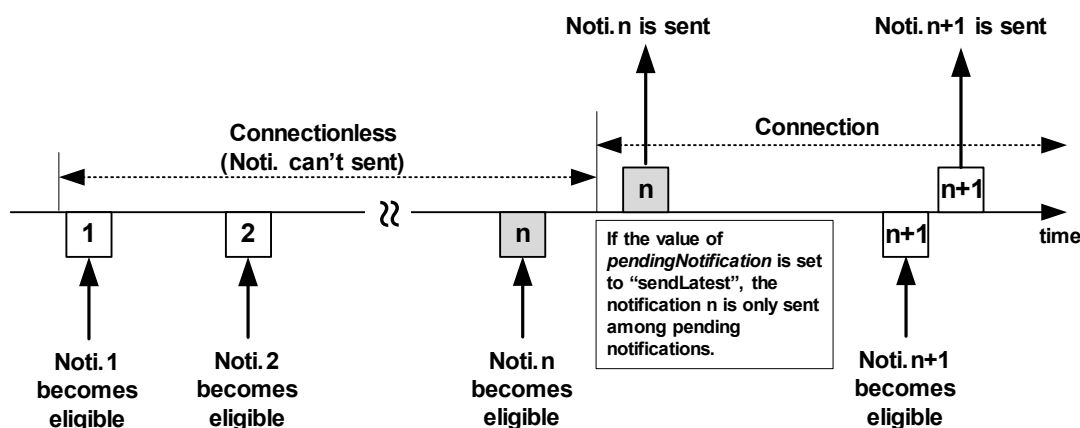

Figure 10.2.12.1-1: Notification Mechanism when *pendingNotification* (sendLatest) is used

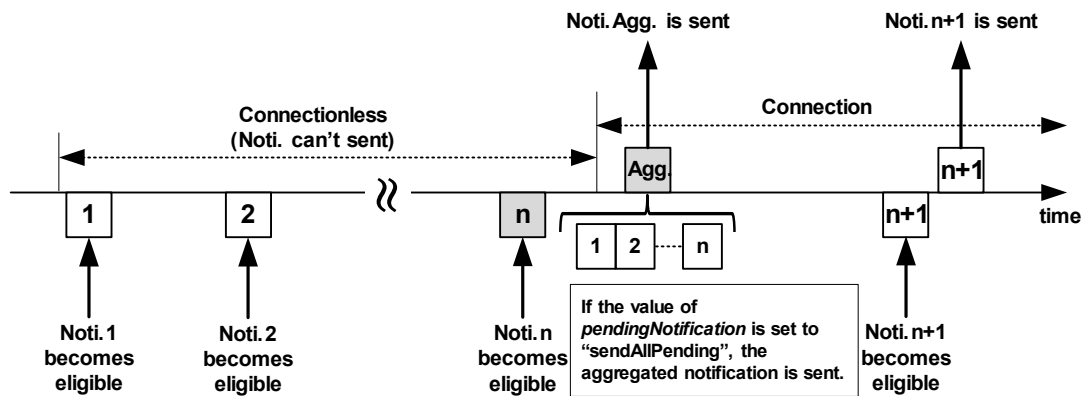

Figure 10.2.12.1-2: Notification Mechanism when pendingNotification (sendAllPending) is used

In the case an Originator wants (for example in the case where notification events occur on an irregular basis) that notifications are sent for events generated prior to the creation of this subscription, it may set the *preSubscriptionNotify* attribute (notification policy) to express its notification policy. The *preSubscriptionNotify* policy is based upon a number of prior notifications that the Originator wants to be sent. When creating a subscription the Hosting CSE checks the *preSubscriptionNotify* policy. If caching of retained notifications is supported on the Hosting CSE and contains the subscribed events then prior notification events shall be sent to Receiver(s) up to the number requested by the *preSubscriptionNotify* policy. If caching of retained notifications is supported for the subscribed events but the available number of prior notification events is less than the number requested then the Hosting CSE shall send those notifications. If caching of retained notifications is not supported, then the response to the subscription creation request shall include a warning. The *preSubscriptionNotify* policy may be used simultaneously with any other notification policy. The scope of the *preSubscriptionNotify* policy is the Hosting CSE for the one subscription it is set in, and does not extend to transit CSEs.

The *latestNotify* attribute (notification policy) indicates if the Originator is only interested in the latest state of the subscribed-to resource. If the *latestNotify* attribute is set, the Hosting CSE shall assign *Event Category* parameter of value 'latest' to the latest notifications generated pertaining to the subscription created. In the case the Receiver is a transit CSE which forwards or aggregates the notifications before sending them to the Originator or the other transit CSEs, upon receiving the notification with the *Event Category* set to 'latest', the transit CSE shall identify the latest notification with the same subscription reference while storing the notifications locally. When the Receiver as a transit CSE needs to send the pending notifications, it shall send the latest notification only for that subscription. The scope of the *latestNotify* policy is the Hosting CSE as well as transit CSEs.

The *notificationContentType* attribute (notification policy) indicates the notification content type that shall be contained in notifications. The *notificationContentType values* shall be "modified attributes" (i.e. send a modified attribute only), or "all attributes" (i.e. send all attributes of the subscribed-to resource), or "ID" of the resource indicated in the notificationEventType condition. If it is not given by the Originator at the creation procedure, the default is "all attributes". The scope of the *notificationContentType* policy is the Hosting CSE for all Originator's subscriptions, and does not extend to transit CSEs.

The *notificationEventCat* attribute (notification policy) indicates an event category of the subscription that shall be included in the notification request to be able for the Notification Target to correctly handle the notification. When the *notificationEventCat* policy is not configured by the Originator, it shall be determined as a default value by the CMDH policy. The scope of the *notificationEventCat* policy is the Hosting CSE for all Originator's subscriptions, and does not extend to transit CSEs.

When the Hosting CSE receives unsuccessful Notify response with subscription verification failure information, the Hosting CSE shall send unsuccessful result to the Originator of the corresponding <subscription> creation procedure if it has not created the <subscription> resource, otherwise the Hosting CSE may delete the corresponding <subscription> resource.

Table 10.2.12.1-1: Notification Procedure

Description	
Associated Reference Point	Mca, Mcc and Mcc'
Information in Request message	According to clause 10.1.5 with the following additions: Content: <ul style="list-style-type: none"> notification data that represents the content of subscribed-to resource may be included. The content is decided by <i>notificationContentType</i> attribute subscription reference (i.e. address of the corresponding <subscription> resource) that generates this notification shall be included notification event type shall be included monitored operation and its Originator information shall be included when <i>operationMonitor</i> condition in the <i>eventNotificationCriteria</i> attribute is configured <i>notificationForwardingURI</i> in case the subscriber intends the group to aggregate the notifications
Processing at Originator before sending Request	Notification is triggered regarding subscription information in a <subscription> resource
Processing at Receiver	According to clause 10.1.5
Information in Response message	According to clause 10.1.5
Processing at Originator after receiving Response	If the response includes 'targetRemoval' indicator which is set to TRUE, then the Notifier(i.e. the Originator of the Notify request) shall perform the procedure in clause 10.2.12.2.1 (Notification target removal handling procedure)
Exceptions	According to clause 10.1.5

10.2.12.2 Procedure for Target Receivers of Notifications

10.2.12.2.0 Overview

A notifier can request verification of a Notification Target by including the Originator ID of the subscription creator in the notify request that it generates towards the Notification Target for that purpose. In this case, the Notification Target shall check if both the Notify Originator and the corresponding <subscription> creation Originator have NOTIFY privilege.

- If either of the two checks are not successful, the Receiver shall return an unsuccessful response to the Originator with subscription verification failure information.
- Otherwise, the Receiver shall send successful response to the Originator.

If the Notification Target wants to remove itself from the Notification Target list (i.e. *notificationURI* attribute of the corresponding <subscription> resource), it shall follow one of the procedures below:

- The Notification Target shall set in a Notify response the 'targetRemoval' indicator to TRUE after receiving a Notify request.

NOTE: In this case the Notification Target will not know the outcome of its removal request immediately.

- The Notification Target shall send a Delete Request to the <*notificationTargetRemove*> virtual resource.

For either of the above procedures, the Notifier shall handle that according to the *action* attribute defined in the corresponding <*notificationTargetDisposition*> resource for the Notification Target.

10.2.12.2.1 Notification Target removal handling procedure

The Notifier (i.e. the Originator of the Notify request) shall handle the notification target removal based on a *<notificationTargetPolicy>* resource. Selecting the applicable *<notificationTargetPolicy>* resource shall be performed as follows:

- Check if there's a *<notificationTargetMgmtPolicyRef>* resource as a child of the *<subscription>* resource which includes the Notification Target in the *notificationTargetURI* attribute. If one is located, the Notifier shall apply the *<notificationTargetPolicy>* resource specified in the *notificationPolicyID* attribute in the matching *<notificationTargetMgmtPolicyRef>* resource.
- Otherwise, the Notifier shall check if there is a *<notificationTargetMgmtPolicyRef>* resource which has the *creator* attribute set in the corresponding *<subscription>* resource and there is a *<notificationTargetPolicy>* resource which has the *policyLabel* attribute set as "default" and the *creator* attribute is equal to the *creator* of the *<subscription>* resource.
- Otherwise, the Notifier shall fetch the *<notificationTargetPolicy>* resource which has the *policyLabel* attribute set as "default".

With the selected *<notificationTargetPolicy>* resource, the Notifier shall handle the target removal as specified in the *action* attribute of the *<notificationTargetPolicy>* resource. If there's *<policyDeletionRules>* resource(s) then the action shall be applied when the rule(s) is satisfied.

The action shall be performed as follows:

- If the action is "accept", then the Notifier shall remove the address which is corresponding to the Notification Target and returns a successful response if applicable.
- If the action is "reject" and if the target removal was requested with Delete request (clause 10.2.25.1), then the Notifier shall return an unsuccessful response if applicable.
- If the action is "seek authorization from the subscription creator", then the Notifier shall return a successful response to the Notification Target if applicable and shall send a Notify request including the ID of the *<subscription>* resource, the Notification Target, and the 'removalAuthorization' indicator which is set as TRUE, to the subscription creator. When the Notifier gets successful response from the creator, then the Notifier shall remove the address which is corresponding to the Notification Target.
- If the action is "inform the subscription creator", then the Notifier shall return a successful response to the Notification Target if applicable and shall send a Notify request including the ID of the *<subscription>* resource, the Notification Target, and the 'targetRemoval' indicator which is set as TRUE to the subscription creator.

10.2.13 Polling Channel Management Procedures

10.2.13.1 Introduction

An AE or a CSE that is request unreachable cannot receive a request from other entities directly. Instead this AE/CSE can retrieve requests that others sent to this AE/CSE once it created *<pollingChannel>* resource on a request reachable CSE.

This clause consist of manipulation procedures of *<pollingChannel>* resource (clauses 10.2.13.2 to 10.2.13.5), re-targeting request to *<pollingChannel>* resource (clause 10.2.13.6), the long polling procedure to retrieve requests from *<pollingChannel>* resource (clause 10.2.13.7) and the responding to the request received by long polling (clause 10.2.13.8). This is depicted in figure 10.2.13.1-1.

Figure 10.2.13.1-1 depicts the case when the Originator sent a request("req2") to the Target as a blocking request. The request can be any of the requests defined in clause 10.2 (e.g. *<container>* resource creation on the Target CSE). As defined in clause 10.2.13.7, polling response contains the "req2" in step 0004. Also as per clause 10.2.13.8, in step 005 the "req3" contains the "resp2", which is the response to the "req2" in step 002 and step 004, in the "req3". Finally the "resp2" is forwarded to the Originator in step 006.

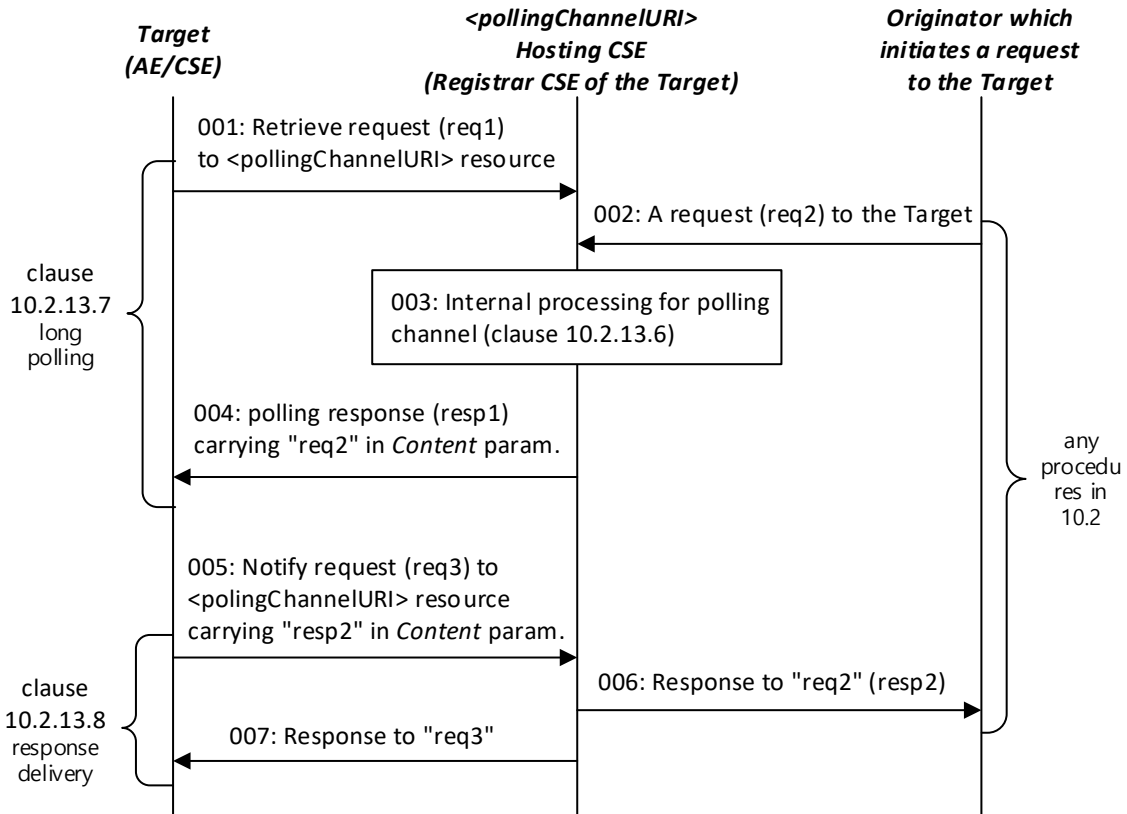

Figure 10.2.13.1-1: Request/response delivery via polling channel

10.2.13.2 Create <pollingChannel>

Table 10.2.13.2-1: <pollingChannel> CREATE

<pollingChannel> CREATE	
Associated Reference Point	Mca and Mcc
Information in Request message	All parameters defined in table 8.1.2-3 apply with the specific details for: To: Address of <AE> or <remoteCSE> resource Content: attributes of the <pollingChannel> resource as defined in clause 9.6.21
Processing at Originator before sending Request	According to clause 10.1.1.1 with the following additions: <ul style="list-style-type: none"> If an AE is the Originator, it shall address the <AE> resource that it already created. Otherwise, if a CSE is the Originator, it shall address the <remoteCSE> resource that it already created
Processing at Receiver	According to clause 10.1.1.1 with the replacement for sub-step 1) of Step 002 as follows: <ul style="list-style-type: none"> The Hosting CSE shall check if the Originator ID is the same as the CSE-ID or AE-ID of the parent resource which is the <remoteCSE> or <AE> resource. If the check fails, the request shall be rejected
Information in Response message	According to clause 10.1.1
Processing at Originator after receiving Response	The Originator should send a retrieve request to the <pollingChannelURI> resource
Exceptions	According to clause 10.1.1

10.2.13.3 Retrieve <pollingChannel>

This procedure is used to retrieve a <pollingChannel> resource and an AE/CSE can be an Originator.

Table 10.2.13.3-1: <pollingChannel> RETRIEVE

<pollingChannel> RETRIEVE	
Associated Reference Point	Mca and Mcc
Information in Request message	All parameters defined in table 8.1.2-3 apply with the specific details for: Content: void
Processing at Originator before sending Request	According to clause 10.1.2
Processing at Receiver	According to clause 10.1.2 with the following for Step 002: <ul style="list-style-type: none"> For access privilege checking, the Hosting CSE shall check if the Originator ID is the same as the CSE-ID or AE-ID of the parent resource which is the <remoteCSE> or <AE> resource, respectively. If the check fails, the request shall be rejected
Information in Response message	All parameters defined in table 8.1.3-1 apply with the specific details for: Content: attributes of the <pollingChannel> resource as defined in clause 9.6.21
Processing at Originator after receiving Response	According to clause 10.1.2
Exceptions	According to clause 10.1.2

10.2.13.4 Update <pollingChannel>

This procedure is used to update a <pollingChannel> resource and an AE/CSE can be an Originator.

Table 10.2.13.4-1: <pollingChannel> UPDATE

<pollingChannel> UPDATE	
Associated Reference Point	Mca and Mcc
Information in Request message	All parameters defined in table 8.1.2-3 apply with the specific details for: Content: attributes of the <pollingChannel> resource as defined in clause 9.6.21
Processing at Originator before sending Request	According to clause 10.1.3
Processing at Receiver	<ul style="list-style-type: none"> According to clause 10.1.3 with the following for Step 002: For access privilege checking, the Hosting CSE shall check if the Originator ID is the same as the CSE-ID or AE-ID of the parent resource which is the <remoteCSE> or <AE> resource, respectively. If the check fails, the request shall be rejected
Information in Response message	According to clause 10.1.3
Processing at Originator after receiving Response	According to clause 10.1.3
Exceptions	According to clause 10.1.3

10.2.13.5 Delete <pollingChannel>

This procedure is used to delete a <pollingChannel> resource and an AE/CSE can be an Originator.

Table 10.2.13.5-1: <pollingChannel> DELETE

<pollingChannel> DELETE	
Associated Reference Point	Mca and Mcc
Information in Request message	All parameters defined in table 8.1.2-3 apply
Processing at Originator before sending Request	According to clause 10.1.4
Processing at Receiver	According to clause 10.1.4 for Step 002: <ul style="list-style-type: none"> For access privilege checking, the Hosting CSE shall check if the Originator ID is the same as the CSE-ID or AE-ID of the parent resource which is the <remoteCSE> or <AE> resource, respectively. If the check fails, the request shall be rejected
Information in Response message	According to clause 10.1.4
Processing at Originator after receiving Response	According to clause 10.1.4
Exceptions	According to clause 10.1.4

10.2.13.6 Internal Processing for Polling Channel

This procedure is used to forward a request to a request-unreachable AE or CSE (i.e. *requestReachability* attribute of its <AE> or <remoteCSE> resource is set to FALSE) which has created a <pollingChannel> resource as a child of its <AE> or <remoteCSE> resource. When a <pollingChannel> Hosting CSE receives a request towards the AE or CSE, it shall forward the request to the AE or CSE in the **Content** parameter of the response to polling response (see clause 10.2.13.7). If there is no pending polling request from the AE or CSE, then the <pollingChannel> Hosting CSE shall store the request and forward it when it receives the polling request. When the stored request expires according to its **Request Expiration Timestamp** parameter the Hosting CSE shall return an error to the entity that initiated the request.

10.2.13.7 Long Polling on Polling Channel

This procedure is originated by a request-unreachable entity to poll requests from a polling channel. Once the Originator starts long polling on a polling channel by sending a RETRIEVE request, the Receiver who is the <pollingChannel> Hosting CSE holds the request until it has any requests to return to the Originator. If the request expires and there's no available request to return, the Receiver shall send the response with a status indicating a timeout has occurred to inform the Originator that a new polling request should be generated again.

Table 10.2.13.7-1: <pollingChannelURI>RETRIEVE

Long Polling RETRIEVE	
Associated Reference Point	Mca and Mcc
Information in Request message	All parameters defined in table 8.1.2-3 apply with the specific details for: To: Address of <pollingChannelURI> child resource of the <pollingChannel> resource
Processing at Originator before sending Request	According to clause 10.1.2
Processing at Receiver	According to clause 10.1.2 with the following privilege check for step 002: <ul style="list-style-type: none"> The Hosting CSE shall check if the Originator ID is the same as the CSE-ID or AE-ID of the grant parent <remoteCSE> or <AE> resource, respectively The Hosting CSE shall check if there is any request to be returned to the Originator. If there is any, the Hosting CSE shall generate the response containing the request(s) for the Originator. If none, the Hosting CSE shall wait for any request for the Originator to be reached at the polling channel until the request expiration time
Information in Response message	All parameters defined in table 8.1.3-1 apply with the specific details for: Content: request message(s) targeting the Originator
Processing at Originator after receiving Response	If the Originator receives the response from the Receiver that the long polling request is expired, the Originator should send a new long polling request
Exceptions	If the long polling request is expired at the Receiver, the Receiver shall send an unsuccessful response to the Originator

10.2.13.8 Delivering the response to the request sent over polling channel

When a Registree CSE received a request from the <pollingChannel> Hosting CSE contained in a <pollingChannelURI> Retrieve response (clause 10.2.13.7), the Registree CSE shall send the response to the received request in a new request to the <pollingChannelURI> Hosting CSE. This request, which contains the response in the **Content** parameter, shall target the <pollingChannelURI> resource with Notify operation.

When the Hosting CSE receives a Notify request to the <pollingChannelURI> resource, the Hosting CSE shall send the response, which was contained in the **Content** parameter of the Notify request, to the entity that sent the associated request to the Hosting CSE. The associated request is the request that the Hosting CSE received and forwarded to the Registree CSE over the polling channel. The association shall be done by matching the **Request Identifier** parameter of the request delivered in <pollingChannelURI> Retrieve response and the **Request Identifier** parameter of the response delivered in the **Content** parameter in a <pollingChannelURI> Notify request.

Table 10.2.13.8-1: <pollingChannelURI> NOTIFY

<pollingChannelURI> NOTIFY	
Associated Reference Point	Mcc
Information in Request message	All parameters defined in table 8.1.2-3 apply with the specific details for: To: Address of <pollingChannelURI> resource Content: The response to the request contained in <pollingChannelURI> Retrieve response
Processing at Originator before sending Request	Originator shall handle and generate the response to the request contained in the <pollingChannelURI> Retrieve response
Processing at Receiver	<ul style="list-style-type: none"> The Hosting CSE shall send the response contained in the Content parameter of Notify request to the entity that sent an associated request to the Hosting CSE
Information in Response message	All parameters defined in table 8.1.3-1 apply
Processing at Originator after receiving Response	According to clause 10.1.5
Exceptions	If the Originator is not the CSE-ID of the <remoteCSE> resource which is the grandparent resource of the <pollingChannelURI> resource, then the Hosting CSE shall reject the request with access privilege error information

10.2.14 <node> Resource Procedures

10.2.14.1 Create <node>

This procedure shall be used for creating a <node> resource.

NOTE: The creation of the <node> resource is on discretion of the Originator. In general the resource is created when the Originator is not always reachable and therefore it is convenient that the entity that the Originator is registered to is aware of the characteristic of the node.

Table 10.2.14.1-1: <node> CREATE

<node> CREATE	
Associated Reference Point	Mca, Mcc and Mcc'
Information in Request message	All parameters defined in table 8.1.2-3 apply with the specific details for: Content: The representation of the <node> resource described in clause 9.6.18 The following attributes from clause 9.6.18 are mandatory for the request: <ul style="list-style-type: none"> <i>resourceType</i> which shall be set to the appropriate tag that identify the <node> resource as defined in clause 9.6.1.3 (see note)
Processing at Originator before sending Request	According to clause 10.1.1.1
Processing at Receiver	According to clause 10.1.1.1
Information in Response message	All parameters defined in table 8.1.3-1 apply with the specific details for: <ul style="list-style-type: none"> Content: Address of the created <node> resource, according to clause 10.1.1.1
Processing at Originator after receiving Response	According to clause 10.1.1.1
Exceptions	According to clause 10.1.1.1
NOTE:	If the Originator is a CSE, it could take the information that is stored in the <node> resource under its own <CSEBase> resource and provide the information in the Content .

10.2.14.2 Retrieve <node>

This procedure shall be used for retrieving the attributes of a <node> resource.

Table 10.2.14.2-1: <node> RETRIEVE

<node> RETRIEVE	
Associated Reference Point	Mca, Mcc and Mcc'
Information in Request message	All parameters defined in table 8.1.2-3 apply with the specific details for: Content: Void
Processing at Originator before sending Request	According to clause 10.1.2
Processing at Receiver	According to clause 10.1.2
Information in Response message	All parameters defined in table 8.1.3-1 apply with the specific details for: Content: Attributes of the <node> resource as defined in clause 9.6.6
Processing at Originator after receiving Response	According to clause 10.1.2
Exceptions	According to clause 10.1.2

10.2.14.3 Update <node>

This procedure shall be used for updating the attributes and the actual data of a <node> resource and its child resources.

Table 10.2.14.3-1: <node> UPDATE

<node> UPDATE	
Associated Reference Point	Mca, Mcc and Mcc'
Information in Request message	All parameters defined in table 8.1.2-3 apply with the specific details for: Content: attributes of the <node> resource as defined in clause 9.6.18 which need be updated, with the exception of the Read Only (RO) attributes cannot be modified
Processing at Originator before sending Request	According to clause 10.1.3
Processing at Receiver	According to clause 10.1.4 with the following: <ul style="list-style-type: none">The Receiver shall check whether the provided attributes of the <node> resource represent a valid request for updating <node> resource
Information in Response message	According to clause 10.1.3
Processing at Originator after receiving Response	According to clause 10.1.3
Exceptions	According to clause 10.1.3

10.2.14.4 Delete <node>

This procedure shall be used for deleting an existing <node> resource.

Table 10.2.14.4-1: <node> DELETE

<node> DELETE	
Associated Reference Point	Mca, Mcc and Mcc'
Information in Request message	All parameters defined in table 8.1.2-3 apply
Processing at Originator before sending Request	According to clause 10.1.4
Processing at Receiver	According to clause 10.1.4
Information in Response message	According to clause 10.1.4
Processing at Originator after receiving Response	According to clause 10.1.4
Exceptions	According to clause 10.1.4

10.2.15 Service Charging and Accounting Procedures

10.2.15.1 Introduction

10.2.15.1.0 Overview

Clause 10.2.15.1 is informative and provides a use case example to explain how the Infrastructure Node provides statistics for AEs using the <statsConfig> and <statsCollect> resources as defined in clauses 9.6.23, 9.6.24. and 9.6.25.

10.2.15.1.1 Service Event-based Statistics Collection for Applications

Figure 10.2.15.1.1-1 shows an example of service layer event-based charging based on the Infrastructure Node.

- Step 1-2: A statistics collection resource called *<statsConfigSCAI>* was created at the IN-CSE by a billing application. Note that the *<statsConfig>* can also be provisioned. In this use case, the *<statsConfigSCAI>* has the *<eventConfigSCAI>* sub-resource. For this specific use case, the *<eventConfigSCAI>* can be set as following: The *eventID* attribute is set with a unique ID to differentiate from other chargeable events. The *eventType* attribute defines what event will trigger the generation of service statistics collection record and is set to "Data Operation" for this case. *eventStart* and *eventEnd* attributes apply to timer based event so they will not be included in this event. *operationType* attribute will be "RETRIEVE". *dataSize* attribute does not apply so it is not included.
- Step 3-5: In this example, AE1 already registered to IN-CSE. IN-CSE can make the statistics collection configuration accessible by AE. Based on the *<statsConfigSCAI>*, AE1 creates a statistics collection trigger for itself, stored in *<statsCollectAE1>*. AE1 will fill in the information for the collection rule. For example, it fills the *collectingEntityID* attribute with the AE-ID of AE1, and the *collectedEntityID* attribute empty, which means to collect for any entities. *status* attribute is set to "Active". The *statModel* is *event-based*. The *eventID* is set with the same ID value as the *eventID* in the *<eventConfigSCAI>*. This event collection trigger can be stored in the *<eventConfigSCAI>* resource at the IN-CSE and IN-CSE will assign a unique ID in attribute *statsCollectID*.
- Step 6-8: When the configured event happens, i.e. when AE2 performed a RETRIEVE operation to the data stored by AE1 at IN-CSE, the event is recorded by IN-CSE. IN-CSE generates a service statistics collection record and sends it to AE1. AE1 can choose to use such information for statistics or billing. Transfer of the statistics is out of scope of the present document.
- Step 9: The AE of billing application can update or retrieve the charging policies and collection scenarios that it has the access control privilege.

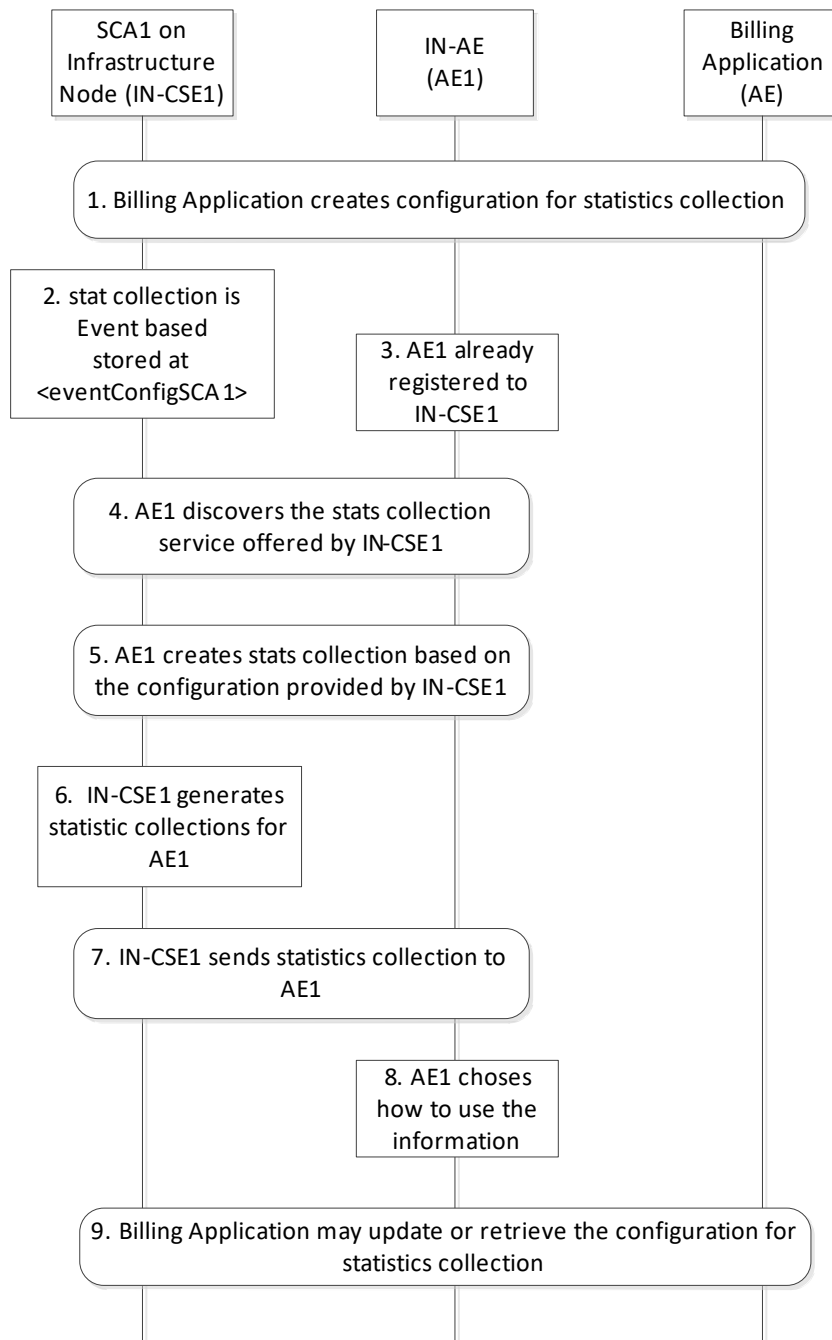

Figure 10.2.15.1.1-1: Event-based Statistics Collection for Applications

10.2.15.2 Create <statsConfig>

This procedure shall be used for the Originator to establish a set of configurations for statistics collection at the Receiver.

The configurations shall be stored at the <statsConfig> resource and each instance of the <statsConfig> resource shall represent a specific configuration.

The Originator shall be an AE that wants to set up the statistics collection configurations.

The Receiver shall be an IN-CSE.

Table 10.2.15.2-1: <statsConfig> CREATE

<statsConfig> CREATE	
Associated Reference Points	Mca
Information in Request message	From: Identifier of the AE that initiates the Request To: The address of the <CSEBase> where the <statsConfig> resource is intended to be Created. Content: The representation of the <statsConfig> resource for which the attributes are described in clause 9.6.23 Other information in the Request message is defined according to clause 10.1.1.1
Processing at Originator before sending Request	The Originator shall request to Create a new <statsConfig> resource by addressing to the <CSEBase> resource of a Hosting CSE. The Originator shall be an AE
Processing at Receiver	According to clause 10.1.1.1
Information in Response message	According to clause 10.1.1.1
Processing at Originator after receiving Response	None
Exceptions	According to clause 10.1.1.1

10.2.15.3 Retrieve <statsConfig>

The RETRIEVE procedure shall be used for the Originator to retrieve the existing <statsConfig> resource from the Receiver.

The Originator shall be an AE that is allowed to retrieve configuration information available for AEs within an IN-CSE.

The Receiver shall be the IN- CSE containing the <statsConfig> resource.

Table 10.2.15.3-1: <statsConfig> RETRIEVE

<statsConfig> RETRIEVE	
Associated Reference Points	Mca
Information in Request message	From: ID of the Originator To: Address of the <statsConfig> resource or its attribute to be retrieved
Processing at Originator before sending Request	The Originator shall request to obtain <statsConfig> resource information by using the RETRIEVE operation. The request shall address the specific <statsConfig> resource or its attributes of a Hosting CSE. The Originator shall be an AE
Processing at Receiver	According to clause 10.1.2
Information in Response message	According to clause 10.1.2
Processing at Originator after receiving Response	According to clause 10.1.2
Exceptions	According to clause 10.1.2

10.2.15.4 Update <statsConfig>

This procedure shall be used for updating <statsConfig> resource.

An UPDATE procedure on the <statsConfig> resource is used for the Originator to update charging related policies at the Receiver.

The Originator shall be the AE that created the <statsConfig> resource. The same AE shall be able to update the resource.

The Receiver shall be a CSE containing the <statsConfig> resource.

Table 10.2.15.4-1: <statsConfig> UPDATE

<statsConfig> UPDATE	
Associated Reference Points	Mca
Information in Request message	From: ID of the Originator To: Address of the <statsConfig> resource to be updated Content: the Originator provides the attributes of <statsConfig> to be updated
Processing at Originator before sending Request	According to clause 10.1.3
Processing at Receiver	According to clause 10.1.3
Information in Response message	According to clause 10.1.3
Processing at Originator after receiving Response	None
Exceptions	According to clause 10.1.3

10.2.15.5 Delete <statsConfig>

This procedure shall be used for deleting <statsConfig> resource.

The Originator shall be the AE that created the <statsConfig> resource.

The Receiver shall be a CSE containing the <statsConfig> resource.

Table 10.2.15.5-1: <statsConfig> DELETE

<statsConfig> DELETE	
Associated Reference Points	Mca
Information in Request message	From: ID of the Originator To: Address of the <statsConfig> resource to be deleted
Processing at Originator before sending Request	According to clause 10.1.4.1
Processing at Receiver	According to clause 10.1.4.1
Information in Response message	According to clause 10.1.4.1
Processing at Originator after receiving Response	None
Exceptions	According to clause 10.1.4.1

10.2.15.6 Create <eventConfig>

This procedure shall be used to create <eventConfig> resource.

Table 10.2.15.6-1: <eventConfig> CREATE

<eventConfig> CREATE	
Associated Reference Points	Mca
Information in Request message	From: Identifier of the AE that initiates the Request To: The address of the <statsConfig> resource where the <eventConfig> sub-resource is intended to be Created Content: The representation of the <eventConfig> resource for which the attributes are described in clause 9.6.24 Other information in the Request message is defined according to clause 10.1.1.1
Processing at Originator before sending Request	The Originator shall be an AE. The Originator shall request to Create a new <eventConfig> resource by addressing to the <statsConfig> resource of a Hosting CSE
Processing at Receiver	The Receiver shall be an IN-CSE: <ul style="list-style-type: none"> • The Receiver shall check if the <i>eventID</i> is unique, and if not, provides a new value • The Receiver shall verify that the <i>eventEnd</i> time is greater than the <i>eventStart</i> time if these two attributes are present • The Receiver shall verify that the <i>dataSize</i> attribute is present and contains a value greater than zero if the <i>eventType</i> is set to "Storage based"
Information in Response message	According to clause 10.1.1.1
Processing at Originator after receiving Response	None
Exceptions	According to clause 10.1.1.1

10.2.15.7 Retrieve <eventConfig>

The RETRIEVE procedure shall be used for the Originator to retrieve the existing <eventConfig> resource from the Receiver.

The Originator shall be an AE that is allowed to retrieve configuration information available for AEs within an IN-CSE.

The Receiver shall be the IN-CSE containing the <eventConfig> resource.

Table 10.2.15.7-1: <eventConfig> RETRIEVE

<eventConfig> RETRIEVE	
Associated Reference Points	Mca
Information in Request message	From: ID of the Originator To: Address of the <eventConfig> resource or its attributes to be retrieved.
Processing at Originator before sending Request	The Originator shall request to obtain <eventConfig> resource information by using the RETRIEVE operation. The request shall address the specific <eventConfig> resource or its attributes of a Hosting CSE. The Originator shall be an AE
Processing at Receiver	According to clause 10.1.2
Information in Response message	According to clause 10.1.2
Processing at Originator after receiving Response	According to clause 10.1.2
Exceptions	According to clause 10.1.2

10.2.15.8 Update <eventConfig>

This procedure shall be used for updating an existing <eventConfig> resource.

The Originator shall be the AE that created the <eventConfig> resource. The same AE shall be able to update the resource.

The Receiver shall be the IN-CSE containing the <eventConfig> resource.

Table 10.2.15.8-1: <eventConfig> UPDATE

<eventConfig> UPDATE	
Associated Reference Points	Mca
Information in Request message	From: ID of the Originator To: Address of the <eventConfig> resource to be updated Content: The Originator provides the attributes of <eventConfig> to be updated The Originator can update attributes under <eventConfig> to update event-based configuration for statistics collection
Processing at Originator before sending Request	According to clause 10.1.3
Processing at Receiver	According to clause 10.1.3
Information in Response message	According to clause 10.1.3
Processing at Originator after receiving Response	None
Exceptions	According to clause 10.1.3

10.2.15.9 Delete <eventConfig>

This procedure shall be used for deleting <eventConfig> resource.

The Originator shall be the AE that created the <eventConfig> resource.

The Receiver shall be the IN-CSE containing the <eventConfig> resource.

Table 10.2.15.9-1: <eventConfig> DELETE

<eventConfig> DELETE	
Associated Reference Points	Mca
Information in Request message	From: ID of the Originator To: Address of the <eventConfig> resource to be deleted
Processing at Originator before sending Request	According to clause 10.1.4.1
Processing at Receiver	According to clause 10.1.4.1
Information in Response message	According to clause 10.1.4.1
Processing at Originator after receiving Response	None
Exceptions	According to clause 10.1.4.1

10.2.15.10 Create <statsCollect>

This procedure shall be used for the Originator to establish collection scenarios at the Receiver.

The collection scenarios are stored at the <statsCollect> resource. Multiple collection scenarios can be created based on one instance of <statsConfig>.

The Receiver shall be an IN-CSE. The Receiver shall validate whether the Originator has proper permissions for creating a <statsCollect> resource. Upon successful validation, create a new <statsCollect> resource with the provided attributes. The IN-CSE shall also create a unique statsCollectID.

Table 10.2.15.10-1: <statsCollect> CREATE

<statsCollect> CREATE	
Associated Reference Points	Mca
Information in Request message	From: Identifier of the AE that initiates the Request To: The Address of the <CSEBase> where the <statsCollect> resource is intended to be Created Content: Contain the resource representation of <statsCollect> Other information in the Request message is defined according to clause 10.1.1.1
Processing at Originator before sending Request	The Originator shall be an AE that wants to set up the collection scenarios to an IN-CSE. The Originator shall request to Create a new <statsCollect> resource by addressing to the <CSEBase> resource of a Hosting CSE The Originator shall populate the attributes for the <statsCollect> resource as defined in clause 9.6.25, except for <i>statsCollectID</i>
Processing at Receiver	In addition to procedures defined in clause 10.1.1.1, the Receiver shall perform the following specific operations: <ul style="list-style-type: none"> • Create <i>statsCollectID</i> which shall be unique in the same service provider domain • Once a <statsCollect> resource instance is created and the <i>status</i> is "ACTIVE", the IN-CSE shall generate service statistics collection records when the conditions defined by the <statsCollect> are met
Information in Response message	According to clause 10.1.1.1
Processing at Originator after receiving Response	None
Exceptions	According to clause 10.1.1.1

10.2.15.11 Retrieve <statsCollect>

The RETRIEVE procedure shall be used for the Originator to retrieve the existing <statsCollect> resource from the Receiver.

The Originator shall be an AE that is allowed to retrieve the collection scenario information from the IN-CSE.

The Receiver shall be the IN- CSE containing the <statsCollect> resource.

Table 10.2.15.11-1: <statsCollect> RETRIEVE

<statsCollect> RETRIEVE	
Associated Reference Points	Mca
Information in Request message	From: ID of the Originator To: Address of the <statsCollect> resource or its attribute to be retrieved
Processing at Originator before sending Request	The Originator shall request to obtain <statsCollect> resource information by using the RETRIEVE operation. The request shall address the specific <statsCollect> resource or its attributes of a Hosting CSE. The Originator shall be an AE
Processing at Receiver	According to clause 10.1.2
Information in Response message	According to clause 10.1.2
Processing at Originator after receiving Response	According to clause 10.1.2
Exceptions	According to clause 10.1.2

10.2.15.12 Update <statsCollect>

An UPDATE procedure on the <statsCollect> resource shall be used for the Originator to update chargeable scenarios at the Receiver.

The Originator shall be the AE that created the <statsCollect> resource. The same AE shall be able to update the resource.

The Receiver shall be the IN-CSE containing the <statsCollect> resource.

Table 10.2.15.12-1: <statsCollect> UPDATE

<statsCollect> UPDATE	
Associated Reference Points	Mca
Information in Request message	From: ID of the Originator To: Address of the <statsCollect> resource to be updated Content: the Originator provides the attributes of <statsCollect> to be updated
Processing at Originator before sending Request	According to clause 10.1.3
Processing at Receiver	According to clause 10.1.3
Information in Response message	According to clause 10.1.3
Processing at Originator after receiving Response	None
Exceptions	According to clause 10.1.3

10.2.15.13 Delete <statsCollect>

This procedure shall be used for deleting <statsCollect> resource.

The Originator shall be the AE that created the <statsCollect> resource.

The Receiver shall be a CSE containing the <statsCollect> resource.

Table 10.2.15.13-1: <statsCollect> DELETE

<statsCollect> DELETE	
Associated Reference Points	Mca
Information in Request message	From: ID of the Originator To: Address of the <statsCollect> resource to be deleted
Processing at Originator before sending Request	According to clause 10.1.4.1
Processing at Receiver	According to clause 10.1.4.1
Information in Response message	According to clause 10.1.4.1
Processing at Originator after receiving Response	None
Exceptions	According to clause 10.1.4.1

10.2.15.14 Service Statistics Collection Record

When the Service Statistics Collection is supported, the Information Elements shall be generated according to table 10.2.15.14-1.

The contents of each Service statistics collection record are decided by the specific collection scenario that triggered the information recording.

Transfer of the Statistics Collection Records over the Mch reference point is not defined in the present document.

Table 10.2.15.14-1: Information Elements for Service Statistics Collection Record

Information Element	Mandatory/optional	Description
<i>statsCollectID</i>	M	It is the unique ID that identifies a specific statistics collection scenario, which triggers information recording for a specific event.
<i>collectingEntityID</i>	M	This is the unique ID of the entity that collects the statistics. It can be an AE-ID or CSE-ID.
<i>collectedEntityID</i>	M	This is the unique ID of the entity whose service layer operation statistics are being collected. It can be an AE-ID or CSE-ID.
<i>event</i>	O	This indicates a specific event type in each record, such as timer based, data operation, storage triggering. It is only present if the <i>statModel</i> is "event based".
<i>eventStart</i>	O	The start time for the recording the M2M event record.
<i>eventEnd</i>	O	The end time for the recording the M2M event record.
<i>transactionType</i>	O	Specifies the detailed type of a transaction, such as CREATE, RETRIEVE, etc.
<i>dataSize</i>	O	Storage Memory in Kbytes, where applicable, to store data associated events with container related operations.
<i>Vendor Specific Information</i>	O	Defines Vendor specific information.

10.2.16 <m2mServiceSubscriptionProfile> Resource Procedures

10.2.16.1 Create <m2mServiceSubscriptionProfile>

This procedure shall be used for creating a <m2mServiceSubscriptionProfile> resource.

Table 10.2.16.1-1: <m2mServiceSubscriptionProfile> CREATE

<m2mServiceSubscriptionProfile> CREATE	
Associated Reference Point	Mca and Mcc
Information in Request message	All parameters defined in table 8.1.2-3 apply with the specific details for: To: The Receiver or Hosting CSE shall be an IN-CSE Content: The resource content shall provide the information as defined in clause 9.6.19
Processing at Originator before sending Request	According to clause 10.1.1.1
Processing at Receiver	According to clause 10.1.1.1
Information in Response message	All parameters defined in table 8.1.3-1 apply with the specific details for: Content: Address of the created <m2mServiceSubscriptionProfile> resource, according to clause 10.1.1
Processing at Originator after receiving Response	According to clause 10.1.1.1
Exceptions	According to clause 10.1.1.1

10.2.16.2 Retrieve <m2mServiceSubscriptionProfile>

This procedure shall be used for retrieving the attributes of a <m2mServiceSubscriptionProfile> resource.

Table 10.2.16.2-1: <m2mServiceSubscriptionProfile> RETRIEVE

<m2mServiceSubscriptionProfile> RETRIEVE	
Associated Reference Point	Mca, Mcc, Mcc'
Information in Request message	All parameters defined in table 8.1.2-3 apply with the specific details for: To: The Receiver or Hosting CSE shall be an IN-CSE Content: Void
Processing at Originator before sending Request	According to clause 10.1.2
Processing at Receiver	According to clause 10.1.2
Information in Response message	All parameters defined in table 8.1.3-1 apply with the specific details for: Content: Attributes of the <m2mServiceSubscriptionProfile> resource as defined in clause 9.6.19
Processing at Originator after receiving Response	According to clause 10.1.2
Exceptions	According to clause 10.1.2

10.2.16.3 Update <m2mServiceSubscriptionProfile>

This procedure shall be used for updating the attributes of a <m2mServiceSubscriptionProfile> resource.

Table 10.2.16.3-1: <m2mServiceSubscriptionProfile> UPDATE

<m2mServiceSubscriptionProfile> UPDATE	
Associated Reference Point	Mca and Mcc
Information in Request message	All parameters defined in table 8.1.2-3 are applicable as indicate in the table with the specific details for: To: The Receiver or Hosting CSE shall be an IN-CSE Content: Attributes of the <m2mServiceSubscriptionProfile> resource as defined in clause 9.6.19 which need be updated, with the exception of the following that cannot be modified: <ul style="list-style-type: none"> • "lastModifiedTime"
Processing at Originator before sending Request	According to clause 10.1.3
Processing at Receiver	According to clause 10.1.3
Information in Response message	According to clause 10.1.3
Processing at Originator after receiving Response	According to clause 10.1.3
Exceptions	According to clause 10.1.3

10.2.16.4 Delete <m2mServiceSubscriptionProfile>

This procedure shall be used for deleting a <m2mServiceSubscriptionProfile> resource residing under a <m2mServiceSubscriptionProfile> resource.

Table 10.2.16.4-1: <m2mServiceSubscriptionProfile> DELETE

<m2mServiceSubscriptionProfile> DELETE	
Associated Reference Point	Mca and Mcc
Information in Request message	All parameters defined in table 8.1.2-3 apply with specific details for: To: The Receiver or Hosting CSE shall be an IN-CSE
Processing at Originator before sending Request	According to clause 10.1.4
Processing at Receiver	According to clause 10.1.4
Information in Response message	According to clause 10.1.4
Processing at Originator after receiving Response	According to clause 10.1.4
Exceptions	According to clause 10.1.4

10.2.17 <serviceSubscribedNode> Resource Procedures

10.2.17.1 Create <serviceSubscribedNode>

This procedure shall be used for creating a <serviceSubscribedNode> resource which is sub-resource of <m2mServiceSubscriptionProfile> resource.

Table 10.2.17.1-1: <serviceSubscribedNode> CREATE

<serviceSubscribedNode> CREATE	
Associated Reference Point	Mca and Mcc
Information in Request message	All parameters defined in table 8.1.2-3 apply with the specific details for: To: The Receiver or Hosting CSE shall be an IN-CSE Content: The resource content shall provide the information as defined in clause 9.6.20
Processing at Originator before sending Request	According to clause 10.1.1.1
Processing at Receiver	According to clause 10.1.1.1
Information in Response message	All parameters defined in table 8.1.3-1 apply with the specific details for: Content: Address of the created <serviceSubscribedNode> resource, according to clause 10.1.1
Processing at Originator after receiving Response	According to clause 10.1.1.1
Exceptions	According to clause 10.1.1.1

10.2.17.2 Retrieve <serviceSubscribedNode>

This procedure shall be used for retrieving the attributes of a <serviceSubscribedNode> resource which is sub-resource of <m2mServiceSubscriptionProfile> resource.

Table 10.2.17.2-1: <serviceSubscribedNode> RETRIEVE

<serviceSubscribedNode> RETRIEVE	
Associated Reference Point	Mca, Mcc and Mcc'
Information in Request message	All parameters defined in table 8.1.2-3 apply with the specific details for: To: The Receiver or Hosting CSE shall be an IN-CSE Content: Void
Processing at Originator before sending Request	According to clause 10.1.2
Processing at Receiver	According to clause 10.1.2
Information in Response message	All parameters defined in table 8.1.3-1 apply
Processing at Originator after receiving Response	According to clause 10.1.2
Exceptions	According to clause 10.1.2

10.2.17.3 Update <serviceSubscribedNode>

This procedure shall be used for updating the attributes of a <serviceSubscribedNode> resource which is sub-resource of <m2mServiceSubscriptionProfile> resource.

Table 10.2.17.3-1: <serviceSubscribedNode> UPDATE

<serviceSubscribedNode> UPDATE	
Associated Reference Point	Mca and Mcc
Information in Request message	All parameters defined in table 8.1.2-3 are applicable as indicate in the table with the specific details for: To: The Receiver or Hosting CSE shall be an IN-CSE Content: Attributes of the <serviceSubscribedNode> resource as defined in clause 9.6.16 which need be updated, with the exception of the following that cannot be modified: " <i>lastModifiedTime</i> "
Processing at Originator before sending Request	According to clause 10.1.3
Processing at Receiver	According to clause 10.1.3
Information in Response message	According to clause 10.1.3
Processing at Originator after receiving Response	According to clause 10.1.3
Exceptions	According to clause 10.1.3

10.2.17.4 Delete <serviceSubscribedNode>

This procedure shall be used for deleting a <serviceSubscribedNode> resource residing under a <m2mServiceSubscriptionProfile> resource.

Table 10.2.17.4-1: <serviceSubscribedNode> DELETE

<serviceSubscribedNode> DELETE	
Associated Reference Point	Mca and Mcc
Information in Request message	All parameters defined in table 8.1.2-3 apply with the specific details for: To: The Receiver or Hosting CSE shall be an IN-CSE
Processing at Originator before sending Request	According to clause 10.1.4
Processing at Receiver	According to clause 10.1.4
Information in Response message	According to clause 10.1.4
Processing at Originator after receiving Response	According to clause 10.1.4
Exceptions	According to clause 10.1.4

10.2.18 Resource Announcement Procedures

10.2.18.1 Procedure for AE and CSE to initiate Creation of an Announced Resource

This clause describes the procedure for an AE or a CSE to initiate the creation of an announced resource.

Figure 10.2.18.1-1 depicts how creation of an announced resource is initiated (clause 10.2.18.1) and the announced resource is created on an announcement target CSE (clause 10.2.18.4).

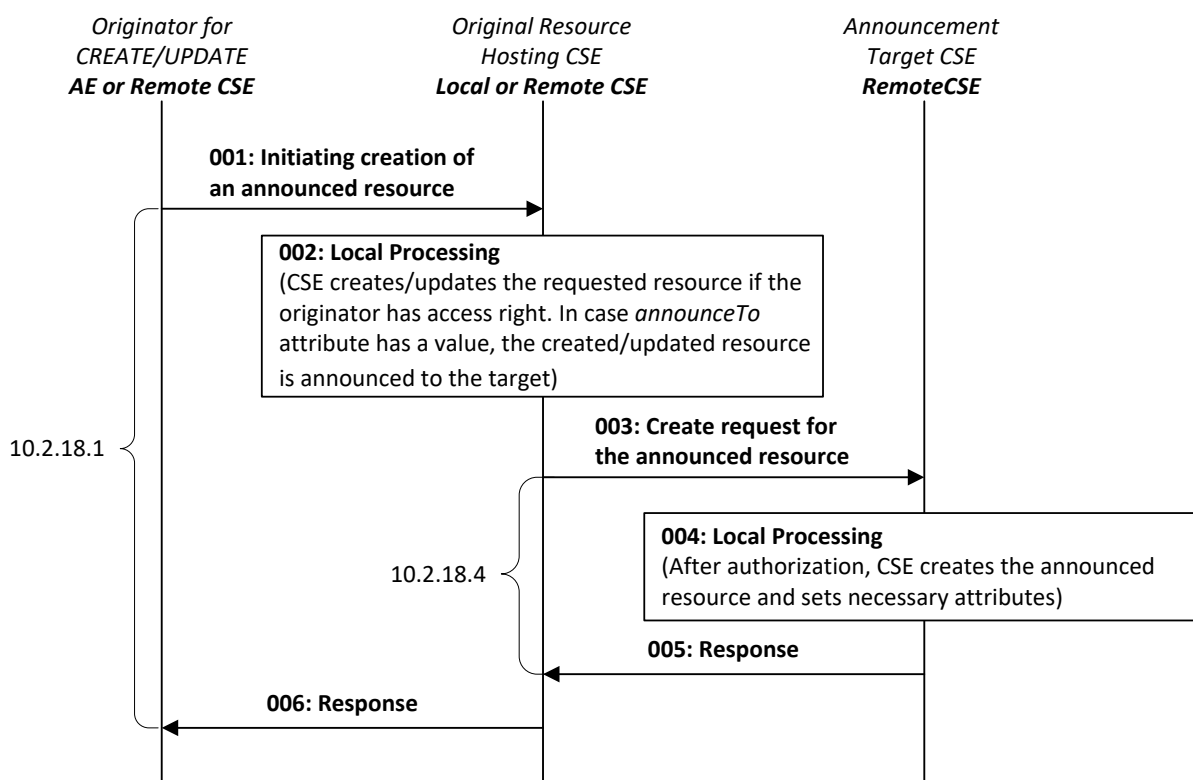

Figure 10.2.18.1-1: Announced resource CREATE procedures

The Originator of a Request for initiating resource announcement can be either an AE or a CSE. Two methods are supported for initiating the creation of an announced resource:

- CREATE: The Originator can initiate the creation of an announced resource during the creation of the original resource by providing *announceTo* attribute in the CREATE Request.

- UPDATE: The Originator can initiate the creation of an announced resource by using the UPDATE Request to update the *announceTo* attribute at the original resource.

Table 10.2.18.1-1: Initiate Resource Announcement: UPDATE or CREATE

Initiate Resource Announcement: CREATE or UPDATE	
Associated Reference Points	Mca and Mcc.
Information in Request message	All parameters defined in table 8.1.2-3 are applicable as indicated in that table. In addition, for the case of the CREATE procedure for a specific resource is described in clause 10.2. The Originator suggests the address(es) or the CSE-ID(s) to which the resource will be announced in the Content parameter.
Processing at the Originator before sending Request	<p>Content: contains address where the resource needs to be announced (within <i>announceTo</i> attribute):</p> <ul style="list-style-type: none"> • The Originator provides either the address(es) for the announced resource or the list of CSE-IDs of the remote CSEs where the original resource needs to be announced by including such information within the <i>announceTo</i> attribute of the UPDATE or CREATE Request.
Processing at the Receiver	<p>Once the Originator has been successfully authorized, the Receiver (which shall be the original resource Hosting CSE) shall grant the Request after successful validation of the Request:</p> <ul style="list-style-type: none"> • If the Request provides address(es) for the announced resource that are not already stored in the <i>announceTo</i> attribute or for newly created <i>announceTo</i> attribute, the Receiver shall announce the resource to the announcement target CSE. • If the Request provides a list of CSE-IDs of the remote CSEs that are not already stored in the <i>announceTo</i> attribute of for the newly created or updated <i>announceTo</i> attribute, the Receiver shall decide the location at the remote CSE(s) identified by CSE-ID(s) and announce the resource to the announcement target CSE. <p>The original resource Hosting CSE shall first check if the parent resource of the original resource has a representation at the announcement target CSE. If that is the case, the announced resource shall be created as a child resource of that representation of the parent resource. If that is not the case, the original Hosting CSE shall next check if it has announced itself to the announcement target CSE. If that is the case, the announced resource shall be created as a child resource of the original Hosting CSE's <remoteCSEAnnc> resource. Otherwise, the original Hosting CSE shall first announce itself by creating a <remoteCSEAnnc> resource as a child resource of the <CSEBase> resource of the announcement target CSE. Next, the announced resource shall be created as a child resource of the original Hosting CSE's <remoteCSEAnnc> resource.</p>
Information in Response message	<p>On successful completion of resource announcement as in clause 10.2.18.4, the Receiver shall provide all parameters defined in table 8.1.3-1 that are applicable as indicated in that table in the Response message:</p> <ul style="list-style-type: none"> • The Receiver shall provide the address(es) of the announced resource to the Originator by updating the content of the <i>announceTo</i> attribute in the original resource and by providing it in the UPDATE or CREATE Response message depending on the type of the Request.
Processing at Originator after receiving Response	<p>According to clause 10.1.1.1 in case of CREATE Request. According to clause 10.1.3 in case of UPDATE Request.</p>
Exceptions	All exceptions described in the basic procedures (clause 10.1.1) are applicable.

10.2.18.2 Procedure at AE or CSE to Retrieve information from an Announced Resource

This clause describes the procedures that shall be use for an AE or a CSE to retrieve information about an announced resource or the corresponding original resource.

Figure 10.2.18.2-1 depicts how the announced resource is retrieved from an announcement target CSE.

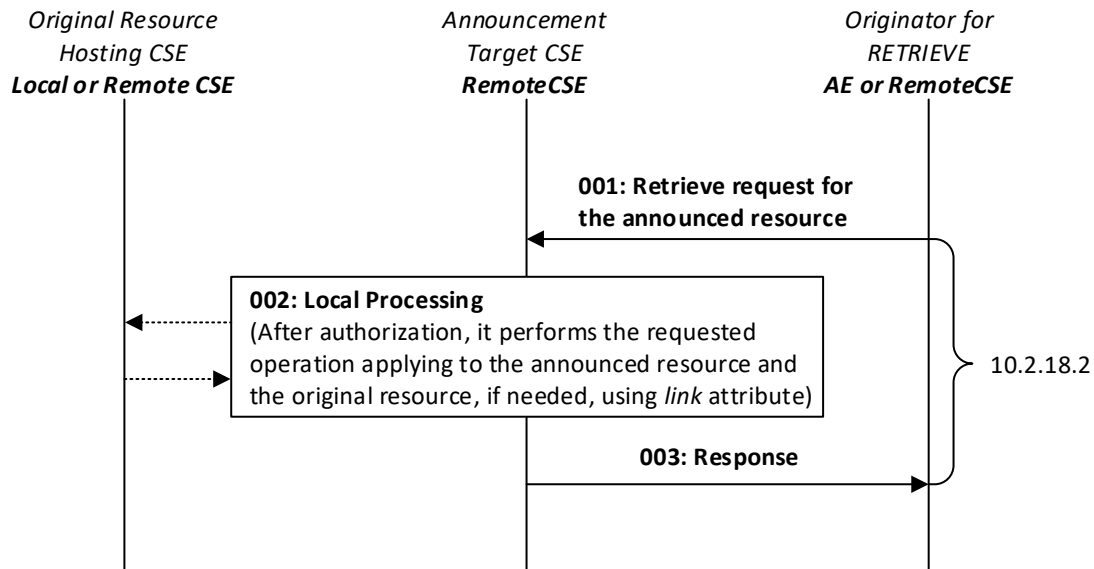

Figure 10.2.18.2-1: Announced resource RETRIEVE procedures

The Originator of a Request for initiating retrieval of information about a resource can be either an AE or a CSE. The Originator initiates this procedure by using RETRIEVE Request.

Table 10.2.18.2-1: Announced Resource Information Retrieval: RETRIEVE

Resource Retrieval: RETRIEVE	
Associated Reference Points	Mca and Mcc.
Information in Request message	<p>Clause 8.1.2 specifies the information to be included in the Request message. Table 8.1.2-3 also describes the parameters that are applicable in the Request message:</p> <ul style="list-style-type: none"> Specifically, the To parameter is set to the address of the announced resource to be retrieved. If a specific attribute is to be retrieved, the address of such attribute is included in the To parameter. The Originator can specify one of the values for the optional Result Content parameter. The Originator can request retrieval of the original resource by targeting the announced resource at the Hosting CSE by setting the Result Content parameter to the "original-resource".
Processing at the Originator before sending Request	The Originator can request retrieval of information from an announced resource at the Hosting CSE. Optionally, the Originator can request retrieval of the original resource by targeting the announced resource at the Hosting CSE by setting the Result Content parameter to the "original-resource".
Processing at the Receiver	<p>Once the Originator has been successfully authorized, the Receiver (Hosting CSE) shall grant the Request after successful validation of the Request:</p> <ul style="list-style-type: none"> Information from the identified announced resource (at Hosting CSE) shall be returned to Originator via RETRIEVE Response, as described in clause 8.1.2. If Result Content request message parameter set to "original-resource" is included in the Request message, the Receiver shall provide the representation of the original resource indicated by the <i>link</i> attribute in the announced resource. The Receiver shall retrieve the original resource to return the representation of the original resource to the Originator.
Information in Response message	Information from the identified announced resource (at Hosting CSE), or the original resource shall be returned to Originator via RETRIEVE Response, as described in clause 8.1.3.
Exceptions	All exceptions described in the basic procedure (clause 10.1.2) are applicable.

10.2.18.3 Procedure for AE and CSE to initiate Deletion of an Announced Resource

This clause describes the procedure that shall be used for an AE or a CSE (not the original resource Hosting CSE) to initiate the deletion of an announced resource.

Figure 10.2.18.1-3 depicts how deletion of an announced resource is initiated (clause 10.2.18.3) and the announced resource is deleted on an announcement target CSE (clause 10.2.18.5).

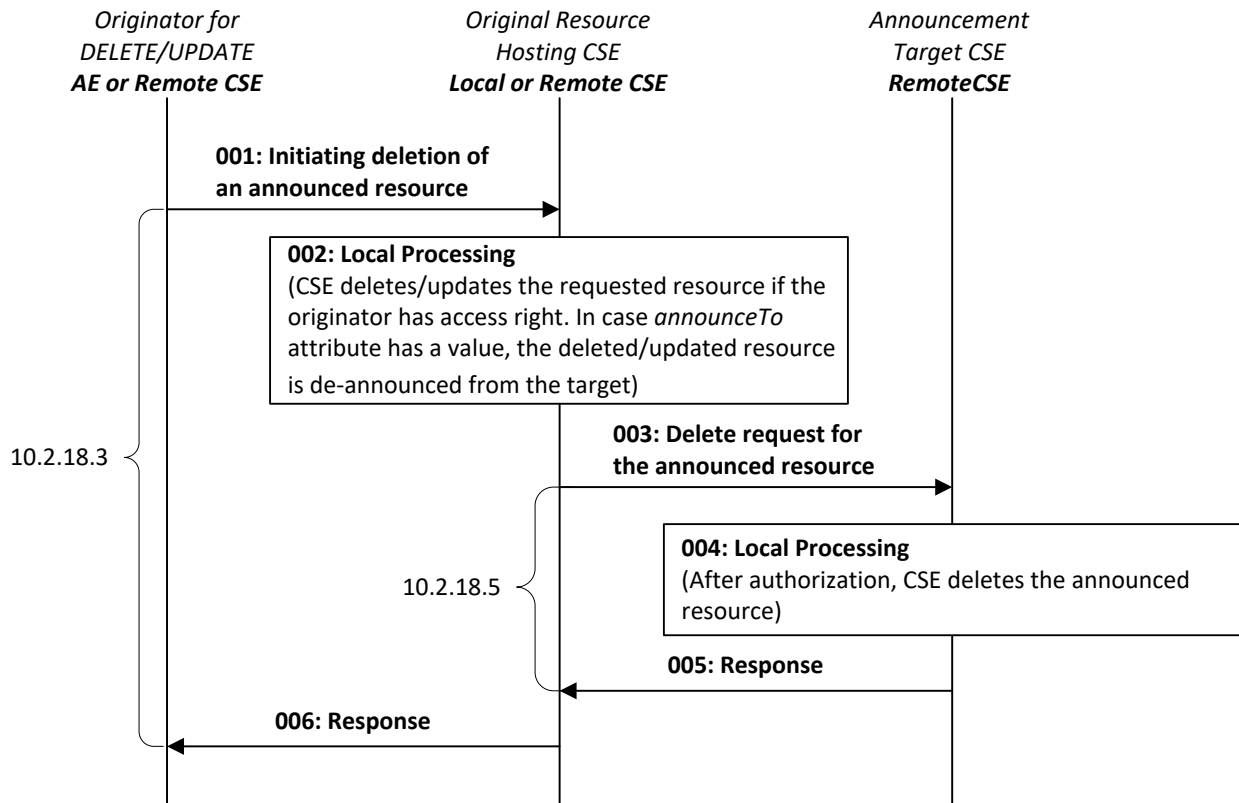

Figure 10.2.18.1-3: Announced resource DELETE procedures

The Originator of a Request for initiating resource de-announcement can be either an AE or a CSE. Two methods are supported for initiating resource de-announcement:

- UPDATE: The Originator can request to initiate the deletion of an announced resource by using UPDATE Request to the *announceTo* attribute at the original resource Hosting CSE.
- DELETE: Resource de-announcement (deletion) shall also be performed when the Originator deletes the original resource at the original resource Hosting CSE by using DELETE Request.

Table 10.2.18.3-1: Initiate Resource De-Announcement: UPDATE and DELETE

Initiate Resource De-Announcement: UPDATE or DELETE	
Associated Reference Points	Mca and Mcc.
Information in Request message	All parameters defined in table 8.1.2-3 are applicable as indicated in that table.
Processing at the Originator before sending Request	<p>The Originator shall perform one of the following for the deletion of an announced resource:</p> <ul style="list-style-type: none"> • The Originator shall request to update the <i>announceTo</i> attribute at the original resource Hosting CSE by providing new content of the <i>announceTo</i> attribute which does not include the CSE-IDs of the announcement target CSEs where the announced resource needs to be de-announced (deleted) by the UPDATE operation. • The Originator shall request to delete the <i>announceTo</i> attribute at the original resource Hosting CSE by sending UPDATE Request that sets the value of the <i>announceTo</i> attribute to NULL for the deletion of all announced resources. • For DELETE operation, the Originator shall include the resource address of the original resource Hosting CSE that needs to be deleted, in the DELETE Request. • Content: Void.
Processing at the Receiver	<p>Once the Originator has been successfully authorized, the Receiver (which shall be the original resource Hosting CSE) shall grant the Request after successful validation of the Request. The Receiver shall be the resource Hosting CSE. On receiving the UPDATE or DELETE Request, the Receiver shall perform as follows:</p> <ul style="list-style-type: none"> • For UPDATE Request, the Receiver shall request to delete the announced resource(s) whose address(es) is/are not included in the <i>announceTo</i> attribute of the request as per procedures in clause 10.2.18.5. • For DELETE Request, the Receiver shall request to delete all announced resources in the <i>announceTo</i> attribute as per procedures in clause 10.2.18.5.
Information in Response message	<p>On successful completion of resource de-announcement procedure in clause 10.2.18.5, the Receiver knows that the announced resource has been deleted:</p> <ul style="list-style-type: none"> • The Receiver shall provide confirmation of resource de-announcement to the Originator. • The content of the updated <i>announceTo</i> attribute shall be provided to the Originator to indicate the successfully deleted announced resource, if the <i>announceTo</i> attribute is not deleted by the Originator in the Request message.
Exceptions	<p>All exceptions described in the basic procedure (clause 10.1.2) are applicable for UPDATE operation.</p> <p>All exceptions described in the basic procedure (clause 10.1.4) are applicable for DELETE operation.</p>

10.2.18.4 Procedure for original resource Hosting CSE to Create an Announced Resource

This clause explains the resource announcement procedure that shall be used by the original resource Hosting CSE to announce the original resource to the remote CSE(s).

See figure 10.2.18.1-1 for the graphical explanation.

The Originator of this Request shall be the original resource Hosting CSE. The Originator shall request to create the announced resource by using CREATE Request.

Table 10.2.18.4-1: Resource Hosting CSE to Announce Resource: CREATE

Resource Announcement: CREATE	
Associated Reference Points	Mcc.
Information in Request message	All parameters defined in table 8.1.2-3 are applicable as indicated in that table. Content: contains MA attributes and OA attributes that are included in <i>announcedAttribute</i> attribute.
Processing at the Originator before sending Request	Other details for the information in the Request message shall be as follows: <ul style="list-style-type: none"> Attributes marked with MA and attributes marked with OA that are included in the <i>announcedAttribute</i> attribute at the original resource shall be provided in the CREATE Request. Such attributes shall have the same value as for the original resource. <i>resourceType</i> which shall be set to the appropriate tag that identifies the <Annc> resource. <i>expirationTime</i> provided by the Originator equal to the one for the original resource. The <i>link</i> attribute of the announced resource shall have the address of the original resource in SP-relative Resource-ID format or Absolute Resource-ID format. The <i>labels</i> attribute of the announced resource shall have the same value as for the original resource. The <i>accessControlPolicyIDs</i> attribute shall always be provided in the CREATE Request even if it is not present in the original resource. In this case the original resource shall include <i>accessControlPolicyIDs</i> from its parent resource or from the local policy at the original resource, as needed. <i>accessControlPolicyIDs</i> and <i>labels</i> attributes, if present at the original resource, shall be provided by the original resource Hosting CSE in the CREATE Request. Such attributes shall have the same value at the original resource and at the announced resource(s).
Processing at the Receiver	Once the Originator has been successfully authorized, the Receiver shall grant the Request after successful validation of the Request. The Receiver shall perform as follows: <ul style="list-style-type: none"> The basic procedure (clause 10.1.1) for the Receiver of the CREATE Request apply. The created announced resource shall include the common attributes specified in clause 9.6.26.1. The created announced resource shall contain the additional attributes that are provided by the Originator; i.e. attributes marked with MA and the attributes marked with OA that are included in the <i>announcedAttribute</i> attribute. The created announced resource shall set the <i>accessControlPolicyIDs</i> attribute to the value received in the Request message, and shall set the <i>labels</i> attribute (if present) and the <i>link</i> attribute to the value received in the Request message. Respond to the Originator with the CREATE Response. In this Response, the address of the successfully announced resource shall be provided.
Information in Response message	All parameters defined in table 8.1.3-1 are applicable as indicated in that table with the specific details for: Content: address where the announced resource is created according to clause 10.1.1.
Processing at Originator after receiving Response	The Originator after receiving the Response from the Receiver shall perform the following steps: <ul style="list-style-type: none"> If the announced resource has been successfully created, the <i>announceTo</i> attribute of the original resource shall be updated to include the address for the successfully announced resource at the Receiver. The <i>announcedAttribute</i> attribute shall be updated as well to represent the successfully announced attributes as received in the Response. For the attributes marked as MA and for the attributes marked as OA that are included in the <i>announcedAttribute</i> attribute, the Originator shall further take the responsibility to keep their values synchronized at the announced resource by using UPDATE operation (clause 10.1.3).
Exceptions	All exceptions described in the basic procedures (clause 10.1.1) are applicable.

10.2.18.5 Procedure for original resource Hosting CSE to Delete an Announced Resource

This clause explains the procedure that shall be used for deleting an announced resource (i.e. the resource de-announcement). This procedure shall be used by the original resource Hosting CSE for deleting the announced resource that resides at the remote CSE.

The Originator of this Request shall be the original resource Hosting CSE.

Table 10.2.18.5-1: Resource Hosting CSE to De-Announce Resource: DELETE

Resource De-Announcement: DELETE	
Associated Reference Points	Mcc.
Information in Request message	All parameters defined in table 8.1.2-3 are applicable as indicate in that table. From: Identifier of the CSE that initiates the Request. To: The address where announced resource needs to be deleted.
Processing at the Originator before sending Request	The Originator shall request to delete an announced resource by using the DELETE Request. To: Parameter provides an address that identifies the announced resource to be deleted.
Processing at the Receiver	If the value of the <i>From</i> parameter in Request message is identical with the CSE-ID included in the <i>link</i> attribute in the announced resource, the Receiver shall grant the Request after successful validation of the Request: <ul style="list-style-type: none"> Delete the announced resource identified by the To parameter in the Request, as per basic procedure in clause 10.1.4. Respond to the Originator with the appropriate DELETE Response, as per basic procedure in clause 10.1.4.
Information in Response message	No change from the basic procedure (clause 10.1.4).
Processing at Originator after receiving Response	The Originator after receiving the Response from the Receiver shall: <ul style="list-style-type: none"> If the announced resource is successfully deleted, the <i>announceTo</i> attribute in the original resource shall be updated to delete the address for the deleted announced resource.
Exceptions	All exceptions described in the basic procedures (clause 10.1.4) are applicable.

10.2.18.6 Procedure for AE and CSE to initiate the Creation of an Announced Attribute

This clause describes the procedure that shall be used for an AE and CSE (not the original resource Hosting CSE) to initiate the creation of an announced attribute (attribute announcement).

The Originator of a Request, for initiating attribute announcement, can be either AE or CSE (not the original resource Hosting CSE).

Table 10.2.18.6-1: Initiate Creation of Announced Attributes

Initiate Attribute Announcement: UPDATE	
Associated Reference Points	Mca and Mcc.
Information in Request message	Parameters defined in table 8.1.2-3 that are applicable for UPDATE. Content parameter includes the names of the attributes to be announced.
Processing at the Originator before sending Request	The Originator shall request attribute announcement by updating the <i>announcedAttribute</i> attribute at the original resource: <ul style="list-style-type: none"> The Originator shall update the <i>announcedAttribute</i> attribute at the original resource by adding the attribute name for the attribute that needs to be announced by using the UPDATE Request. Only the attributes marked with OA can be announced to remote announced resources.
Processing at the Receiver	Once the Originator has been successfully authorized, the Receiver, which shall be the original resource Hosting CSE, shall grant the Request after successful validation of the Request. <ul style="list-style-type: none"> The attributes received in the Request, which are not marked as OA, are invalid. The attributes received in the Request, which are not present in the original resource structure, are invalid. If some attributes received in the Request do not already exist in the <i>announcedAttribute</i> attribute, the Receiver shall announce such attributes to all announced resources listed in the <i>announceTo</i> attribute as per procedures in clause 10.2.18.8. <p>On successful announcement of attributes as per procedures in clause 10.2.18.8, the Receiver shall perform the following:</p> <ul style="list-style-type: none"> The Receiver shall respond to the Originator (requesting AE/CSE) with UPDATE Response as specified in clause 10.1.3. The content of the announced attributes can be provided in such Response.
Information in Response message	Parameters defined in table 8.1.3-1 that are applicable.
Exceptions	All exceptions described in the basic procedures (clause 10.1.3) are applicable.

10.2.18.7 Procedure for AE and CSE to initiate the Deletion of an Announced Attribute

This clause describes the procedure that shall be used for an AE and CSE (not the original resource Hosting CSE) to initiate the deletion of announced attributes (attribute de-announcement).

The Originator of a Request, for initiating attribute de-announcement, can be either AE or CSE (not the original resource Hosting CSE).

Table 10.2.18.7-1: Initiate Deletion of Announced Attributes

Initiate Attribute De-Announcement: UPDATE	
Associated Reference Points	Mca and Mcc.
Information in Request message	Parameters defined in table 8.1.2-3 that are applicable for UPDATE. Content parameter does not include the names of the attributes to be de-announced.
Processing at the Originator before sending Request	The Originator shall request attribute de-announcements by updating the <i>announcedAttribute</i> attribute at the original resource as follows: <ul style="list-style-type: none"> The Originator shall update the <i>announcedAttribute</i> attribute at the original resource by deleting the attribute name for the attribute that needs to be de-announced by using the UPDATE Request. Only the attributes marked with OA can be de-announced to remote announced resources.
Processing at the Receiver	Once the Originator has been successfully authorized, the Receiver, which shall be the original resource Hosting CSE, shall grant the Request after successful validation of the Request: <ul style="list-style-type: none"> The attributes received in the Request, which are not marked as OA, are invalid. If some attributes that exist in the <i>announcedAttribute</i> attribute are not received in the Request (i.e. attributes that need to be deleted by the UPDATE Request), the Receiver shall de-announce such attributes to all announced resources listed in the <i>announceTo</i> attributes as per procedure in clause 10.2.18.9. <p>On successful de-announcement of all attributes as per procedures in clause 10.2.18.9, the Receiver shall perform the following:</p> <ul style="list-style-type: none"> The Receiver shall respond to the Originator (requesting AE/CSE) with UPDATE Response as specified in clause 10.1.3. The names of the de-announced attributes can be provided in such Response.
Information in Response message	Parameters defined in table 8.1.3-1 that are applicable.
Exceptions	All exceptions described in the basic procedures (clause 10.1.3) are applicable.

10.2.18.8 Procedure for original resource Hosting CSE for Announcing Attributes

This clause describes procedure that shall be used by the original resource Hosting CSE to create announced attributes at the remote announced resources (i.e. the attribute announcement).

The Originator of this Request shall be the original resource Hosting CSE.

Table 10.2.18.8-1: Original Resource Hosting CSE to Announce Attribute: UPDATE

Attribute Announcement: UPDATE	
Associated Reference Points	Mcc
Information in Request message	Information described for the Originator of the UPDATE Request as in clause 10.1.3. Content: Parameter includes the names of the attributes to be announced and their values.
Processing at the Originator before sending Request	The Originator shall request to create attributes at the announced resources by using the UPDATE Request as specified in clause 10.1.3. Only parameters marked with OA can be announced.
Processing at the Receiver	Once the Originator has been successfully authorized, the Receiver (CSE hosting announced resource) shall grant the Request after successful validation of the Request. The Receiver shall perform as follows: <ul style="list-style-type: none"> • Create announced attributes at the announced resource as per procedures in clause 10.1.3. The initial value for the announced attributes shall use the same value as with the original resource. • Respond to the Originator with UPDATE Response as in clause 10.1.3.
Information in Response message	Parameters defined in table 8.1.3-1 that are applicable.
Processing at Originator after receiving Response	Originator after receiving the Response from the Receiver shall perform the following steps: <ul style="list-style-type: none"> • If the announced attributes have been successfully created, the <i>announcedAttribute</i> attribute shall be updated to include the attribute names for the successfully announced attributes. • For the newly announced attributes in the <i>announcedAttribute</i> attribute, the Originator shall take the responsibility to keep their values synchronized at the announced resources by using UPDATE operation as in clause 10.1.3.
Exceptions	All exceptions described in the basic procedures (clause 10.1.3) are applicable.

10.2.18.9 Procedure for original resource Hosting CSE for De-Announcing Attributes

This clause describes procedure that shall be used by the original resource Hosting CSE to remove announced attributes at remote announced resources (i.e. the attribute de-announcement).

The Originator of this Request shall be the original resource Hosting CSE.

Table 10.2.18.9-1: Original Resource Hosting CSE to De-Announce Attribute: UPDATE

Attribute De-Announcement: UPDATE	
Associated Reference Point	Mcc.
Information in Request message	Information described for the Originator of the UPDATE Request as in clause 10.1.3. Content: Parameter includes the names of the attributes to be deleted (de-announced) with their values set to NULL.
Processing at the Originator before sending Request	The Originator shall request to delete the announced attributes by using the UPDATE Request as specified in clause 10.1.3. Only attributes marked as OA can be de-announced: Content: Parameter in the UPDATE Request shall provide the names of the attributes to be de-announced by setting their values set to NULL.
Processing at the Receiver	If the value of the <i>From</i> parameter in Request message is identical with the CSE-ID included in the <i>link</i> attribute in the announced resource, the Receiver (CSE hosting announced resource) shall grant the Request after successful validation of the Request. The Receiver shall perform as follows: <ul style="list-style-type: none"> • Delete the de-announced attributes identified by the Content parameter in the UPDATE Request as per procedures in clause 10.1.3. • Respond to the Originator with the appropriate UPDATE Response as in clause 10.1.3.
Information in Response message	Parameters defined in table 8.1.3-1 that are applicable.
Processing at Originator after receiving Response	The Originator after receiving the Response from the Receiver shall perform the following steps: <ul style="list-style-type: none"> • If the attributes have been successfully removed, the <i>announcedAttribute</i> attribute shall be updated so as to remove the attribute names for the successfully de-announced attributes.
Exceptions	All exceptions described in the basic procedures (clause 10.1.3) are applicable.

10.2.18.10 Procedure for original resource Hosting CSE for Updating Attributes

This clause describes procedure that shall be used by the original resource Hosting CSE to update announced attributes at the remote announced resources. The Originator of this Request shall be the original resource Hosting CSE.

Table 10.2.18.10-1: Original Resource Hosting CSE to Update Attribute: UPDATE

Attribute Update: UPDATE	
Associated Reference Point	Mcc.
Information in Request message	Information described for the Originator of the UPDATE Request as in clause 10.1.3. Content: Parameter includes the names of the attributes to be updated with their target values.
Processing at the Originator before sending Request	The Originator shall request to update the announced attributes by using the UPDATE Request as specified in clause 10.1.3. Attributes marked as MA or OA can be updated: Content: Parameter in the UPDATE Request shall provide the names of the attributes to be updated by setting their target values.
Processing at the Receiver	If the value of the <i>From</i> parameter in Request message is identical with the CSE-ID included in the <i>link</i> attribute in the announced resource, the Receiver (CSE hosting announced resource) shall grant the Request after successful validation of the Request. The Receiver shall perform as follows: <ul style="list-style-type: none"> • Update the target attributes identified by the Content parameter in the UPDATE Request as per procedures in clause 10.1.3. • Respond to the Originator with the appropriate UPDATE Response as in clause 10.1.3.
Information in Response message	Parameters defined in table 8.1.3-1 that are applicable.
Exceptions	All exceptions described in the basic procedures (clause 10.1.3) are applicable.

10.2.18.11 Notification Procedure targeting an AE Announced Resource

This clause describes handling of notifications received at an <AEAnnc> resource Hosting CSE.

Table 10.2.18.11-1: Notification Procedure for AE Announced Resource

Notification Procedure for AE Announced Resource	
Associated Reference Point	Mcc
Information in Request message	Notification message made according to clause 10.2.12
Processing at the Originator before sending Request	According to clause 10.1.5
Processing at the Receiver	<AEAnnc> hosting CSE shall forward received notification message to original resource Hosting CSE targeting original <AE> resource when <AE> resource is available
Information in Response message	According to clause 10.1.5
Processing at Originator after receiving Response	According to clause 10.1.5
Exceptions	According to clause 10.1.5

10.2.19 <contentInstance> Resource Procedures

10.2.19.1 Introduction

This clause describes the management procedures for the <contentInstance> resource. Since <contentInstance> resource is immutable once created, there is no procedure for updating it.

10.2.19.2 <contentInstance> CREATE

This procedures shall be used for creating a <contentInstance> resource.

Table 10.2.19.2-1: <contentInstance> CREATE

<contentInstance> CREATE	
Associated Reference Point	Mca, Mcc and Mcc'.
Information in Request message	All parameters defined in table 8.1.2-3 apply with the specific details for: Content: The resource content shall provide the information as defined in clause 9.6.7.
Processing at Originator before sending Request	According to clause 10.1.1.1.
Processing at Receiver	According to clause 10.1.1.1. If the newly created <contentInstance> resource violates any of the policies defined in the parent <container> resource (e.g. <i>maxNrOfInstances</i> or <i>maxByteSize</i>), then the oldest <contentInstance> resources shall be removed from the <container> to enable the creation of the new <contentInstance> resource.
Information in Response message	All parameters defined in table 8.1.3-1 apply with the specific details for: <ul style="list-style-type: none"> Content: Address of the created <contentInstance> resource, according to clause 10.1.1.1.
Processing at Originator after receiving Response	According to clause 10.1.1.1.
Exceptions	According to clause 10.1.1.1.

10.2.19.3 <contentInstance> RETRIEVE

This procedure shall be used for retrieving the attributes of a <contentInstance> resource.

Table 10.2.19.3-1: <contentInstance> RETRIEVE

<contentInstance> RETRIEVE	
Associated Reference Point	Mca, Mcc and Mcc'
Information in Request message	According to clause 10.1.2.
Processing at Originator before sending Request	According to clause 10.1.2.
Processing at Receiver	According to clause 10.1.2. If the <i>disableRetrieval</i> attribute of the parent <container> resource was set as 'TRUE', then the RETRIEVE request shall be rejected (see note).
Information in Response message	All parameters defined in table 8.1.3-1 apply with specific details for: Content: Attributes of the <contentInstance> resources as defined in clause 9.6.7.
Processing at Originator after receiving Response	According to clause 10.1.2.
Exceptions	According to clause 10.1.2.
NOTE: Notification regarding <subscription> on the parent <container> resource shall be.	

10.2.19.4 <contentInstance> UPDATE

The Update operation shall not apply to <contentInstance> resource.

10.2.19.5 <contentInstance> DELETE

This procedure shall be used for deleting a <contentInstance> resource residing under a <container> resource.

Table 10.2.19.5-1: <contentInstance> DELETE

<contentInstance> DELETE	
Associated Reference Point	Mca, Mcc and Mcc'
Information in Request message	All parameters defined in table 8.1.2-3 apply.
Processing at Originator before sending Request	According to clause 10.1.4.
Processing at Receiver	According to clause 10.1.4. The Receiver shall delete the <contentInstance> resource.
Information in Response message	According to clause 10.1.4.
Processing at Originator after receiving Response	According to clause 10.1.4.
Exceptions	According to clause 10.1.4.

10.2.20 <request> Resource Procedures

10.2.20.1 Create <request>

As specified in clause 9.6.12, creation of a <request> resource shall only be done on a Receiver CSE implicitly when a Registree AE or a Registree/Registrar CSE of the Receiver CSE issues a request to the Receiver CSE for targeting any other resource type or requesting a notification in non-blocking mode. Therefore, the creation procedure of a <request> resource cannot be initiated explicitly by an Originator.

The specific conditions to create a <request> resource are as follows: When an AE or CSE issues a request for targeting any other resource type or requesting a notification in non-blocking mode, i.e. the **Response Type** parameter

of the request is set to either '*nonBlockingRequestSynch*' or '*nonBlockingRequestAsynch*', and the Receiver CSE supports the *<request>* resource type as indicated by the *supportedResourceType* attribute of the *<CSEBase>* resource representing the Receiver CSE.

The Receiver CSE of a non-blocking Request that was issued by either:

- a Registrar AE of the Receiver CSE; or
- a Regtree/Registrar CSE of the Receiver CSE;

is the Hosing CSE for the *<request>* resource that shall be associated with the non-blocking request.

The Hosting CSE shall follow the procedure outlined in this clause.

Step 001: The Receiver shall:

- 1) Assign values to the *resourceID* and *resourceName* attributes of the *<request>* resource to be created.
- 2) Assign a value to the following common attributes specified in clause 9.6.1.3:
 - a) *parentID*;
 - b) *creationTime*;
 - c) *expirationTime*: The Receiver shall assign a value that is consistent with the ***Request Expiration Timestamp***, ***Result Expiration Timestamp*** and ***Result Persistence*** parameters effective for the associated non-blocking request that implied the creation of this *<request>* resource (within the restriction of the Receiver policies). If a value consistent with the ***Request Expiration Timestamp***, ***Result Expiration Timestamp*** and ***Result Persistence*** parameters effective for the associated non-blocking request that implied the creation of this *<request>* resource cannot be supported, due to either policy or subscription restrictions, the Receiver will assign a new value.
 - d) *lastModifiedTime*: which is equals to the creationTime;
 - e) *stateTag*;
 - f) *accessControlPolicyIDs*: Populate with the resource identifier of an *<accessControlPolicy>* that contains the following:
 - i) In the *privileges* attribute:
 - 1) Allow RETRIEVE, UPDATE and DELETE operations for the Hosting CSE.
 - 2) Allow RETRIEVE and DELETE operations for the Originator, i.e. the value of the ***From*** parameter.
 - ii) In the *selfPrivileges* attribute:
 - 1) Allow UPDATE operations for the Originator, i.e. the value of the ***From*** parameter.
- 3) Assign any other RO (Read Only) attributes of *<request>* resource type within the restriction of the Receiver policies:
 - a) Operation: Value of the parameter ***Operation*** in the associated non-blocking request that implied the creation of this *<request>* resource.
 - b) Target: Value of the parameter ***To*** in the associated non-blocking request that implied the creation of this *<request>* resource.
 - c) Originator: Value of the parameter ***From*** in the associated non-blocking request that implied the creation of this *<request>* resource.
 - d) *requestIdentifier*: Value of the parameter ***Request Identifier*** in the associated non-blocking request that implied the creation of this *<request>* resource.

- e) *metaInformation*: The content of this attribute is set to information in any other optional parameters described in clause 8.1. given in the associated non-blocking request that implied the creation of this *<request>* resource.
- f) *content*: Value of the parameter *Content* - if any - in the associated non-blocking request that implied the creation of this *<request>* resource.
- g) *requestStatus*: Information on the initial status of the associated non-blocking request that implied the creation of this *<request>* resource. The initial value of this attribute shall be identical to the status that is contained in the Acknowledgement response message of the associated non-blocking request. Possible values for status information contained in this attribute are specified in oneM2M TS-0004 [3]. The value of this attribute is subject to changes according to the progress in processing of the non-blocking request that implied the creation of this *<request>* resource.
- h) *operationResult*: Initially empty. This attribute will be used for representing the result of the originally requested operation - if any - in line with the *Result Content* parameter in the associated non-blocking request that implied the creation of this *<request>* resource.

Step 002: The Receiver shall create the *<request>* resource.

Table 10.2.20.1-1: *<request>* CREATE

<i><request></i> CREATE	
Associated Reference Point	None
Information in Request message	Not applicable. For <i><request></i> resources, explicit creation via a Request message shall not be supported
Pre-Processing at Originator	Not applicable. There is no Originator. <i><request></i> resources are only created implicitly
Processing at Receiver	Different to the non-registration CREATE procedure described in clause 10.1.1.1, see outlined steps described in the present clause above
Information in Response message	Not applicable. Since <i><request></i> resources shall not be created explicitly, no response messages will be sent after creation. However, the address of a <i><request></i> resource will be passed back as a reference to the Originator of an associated non-blocking request that implied the creation of this <i><request></i> resource
Post-Processing at Originator	None
Exceptions	None

10.2.20.2 Retrieve <request>

This procedure shall be used for retrieving the attributes of a <request> resource.

Table 10.2.20.2-1: <request> RETRIEVE

<request> RETRIEVE	
Associated Reference Point	Mca, Mcc and Mcc'
Information in Request message	All parameters defined in table 8.1.2-3 apply with the specific details for: Content: Void
Pre-Processing at Originator	According to clause 10.1.2 with the following specific processing: Originator needs to retrieve information about an associated previously issued non-blocking request
Processing at Receiver	According to clause 10.1.2 with the following specific processing: The Receiver shall provide the content of the addressed <request> resource or the addressed attributes thereof
Information in Response message	All parameters defined in table 8.1.3-1 apply with the specific details for: Content: Attributes of the <request> resource as defined in clause 9.6.12
Post-Processing at Originator	According to clause 10.1.2
Exceptions	According to clause 10.1.2 According to clause 10.1.1.1 with the following: <ul style="list-style-type: none">• The Originator CSE is not authorized to retrieve the <request> resource or the addressed parts of it• The addressed <request> resource does not exist

10.2.20.3 Update <request>

For a <request> resource explicit update requests shall not be supported. Changes in the attributes of a <request> resource can only be done by the Hosting CSE due to changes of the status of the associated non-blocking request that implied the creation of this <request> resource or due to reception of an operation result in response to the associated non-blocking request that implied the creation of this <request> resource.

10.2.20.4 Delete <request>

This procedure shall be used for deleting an existing <request> resource. Deletion of an existing <request> resource shall terminate any further processing of an associated pending non-blocking request that implied the creation of this <request> resource if the pending request was not already completed or forwarded.

Table 10.2.20.4-1: <request> DELETE

<request> DELETE	
Associated Reference Point	Mca, Mcc and Mcc'
Information in Request message	All parameters defined in table 8.1.2-3 apply
Pre-Processing at Originator	According to clause 10.1.4 with the following: Originator needs to cancel a previously issued non-blocking request that is still pending, i.e. it has not yet been completed or Originator needs to remove the <request> resource representing the context of an already completed non-blocking request
Processing at Receiver	According to clause 10.1.4: <ul style="list-style-type: none"> Receiver CSE checks if the associated non-blocking request process is still pending. If so, it stops that request process Receiver CSE removes the addressed <request> resource
Information in Response message	According to clause 10.1.4 with the following specific information: Successful Response message indicating that the associated non-blocking request process was stopped as requested or the context of an already completed associated non-blocking request was deleted
Post-Processing at Originator	According to clause 10.1.4
Exceptions	According to clause 10.1.4 with the following: <ul style="list-style-type: none"> The Originator CSE is not authorized to delete the <request> resource The addressed <request> resource does not exist

10.2.21 <accessControlPolicy> Resource Procedures

10.2.21.1 Create <accessControlPolicy>

This procedure shall be used to create an <accessControlPolicy> resource.

Table 10.2.21.1-1: <accessControlPolicy> CREATE

<accessControlPolicy> CREATE	
Associated Reference Point	Mca, Mcc and Mcc'.
Information in Request message	Same as clause 10.1.1.
Pre-Processing at Originator	Same as clause 10.1.1.
Processing at Receiver	Same as clause 10.1.1.
Information in Response message	Same as clause 10.1.1.
Post-Processing at Originator	Same as clause 10.1.1.
Exceptions	Same as clause 10.1.1.

10.2.21.2 Retrieve <accessControlPolicy>

This procedure shall be used to retrieve attributes and child resource information of the <accessControlPolicy> resource.

Table 10.2.21.2-1: <accessControlPolicy> RETRIEVE

<accessControlPolicy> RETRIEVE	
Associated Reference Point	Mca, Mcc and Mcc'.
Information in Request message	Same as clause 10.1.2.
Pre-Processing at Originator	Same as clause 10.1.2.
Processing at Receiver	Addition to clause 10.1.2: <ul style="list-style-type: none"> The Receiver shall check access control rules defined in <i>selfPrivileges</i> of the <accessControlPolicy> resource.
Information in Response message	Same as clause 10.1.2.
Post-Processing at Originator	Same as clause 10.1.2.
Exceptions	Addition to clause 10.1.2.

10.2.21.3 Update <accessControlPolicy>

This procedure shall be used to update attributes information of the <accessControlPolicy> resource.

Table 10.2.21.3-1: <accessControlPolicy> UPDATE

<accessControlPolicy> UPDATE	
Associated Reference Point	Mca, Mcc and Mcc'
Information in Request message	Same as clause 10.1.3.
Pre-Processing at Originator	Same as clause 10.1.3.
Processing at Receiver	Addition to clause 10.1.3: <ul style="list-style-type: none">The Receiver shall check access control rules defined in <i>selfPrivileges</i> of the <accessControlPolicy> resource.
Information in Response message	Same as clause 10.1.3.
Post-Processing at Originator	Same as clause 10.1.3.
Exceptions	Addition to clause 10.1.3.

10.2.21.4 Delete <accessControlPolicy>

This procedure shall be used to delete the <accessControlPolicy> resource.

Table 10.2.21.3-1: <accessControlPolicy> DELETE

<accessControlPolicy> DELETE	
Associated Reference Point	Mca, Mcc and Mcc'
Information in Request message	Same as clause 10.1.4.
Pre-Processing at Originator	Same as clause 10.1.4.
Processing at Receiver	Addition to clause 10.1.4: <ul style="list-style-type: none">The Receiver shall check access control rules defined in <i>selfPrivileges</i> of the <accessControlPolicy> resource.
Information in Response message	Same as clause 10.1.4.
Post-Processing at Originator	Same as clause 10.1.4.
Exceptions	Addition to clause 10.1.4.

10.2.22 <latest> Resource Procedures

10.2.22.0 Overview

Only Retrieve and Delete operations shall be allowed for the <latest> resource.

10.2.22.1 Retrieve <latest>

If *locationID* of <container> is configured, the procedure specified in clause 10.2.10.2.2 shall apply.

If *locationID* of <container> is not configured, this procedure shall apply to the latest <contentInstance> resource among all existing <contentInstance> resources in the parent <container> resource. If there is no <contentInstance> resource in the parent, then the Receiver shall responded with an error.

This procedure is the same as the procedures in clause 10.2.19.3 <contentInstance> RETRIEVE.

10.2.22.2 Delete <latest>

This procedure shall apply to the latest <contentInstance> resource among all existing <contentInstance> resources in the parent <container> resource. If there is no <contentInstance> resource in the parent, then the Receiver shall responded with an error.

After deletion, the <latest> contentInstance will point to the latest <contentInstance> among all remaining <contentInstance> resources in the parent <container> resource. This procedure is the same as the procedures in clause 10.2.19.4 <contentInstance> DELETE.

10.2.23 <oldest> Resource Procedure

10.2.23.0 Overview

Only Retrieve and Delete operations shall be allowed for the <oldest> resource.

10.2.23.1 Retrieve <oldest>

This procedure shall apply to the oldest <contentInstance> resource among all existing <contentInstance> resources in the parent <container> resource. If there is no <contentInstance> resource in the parent, then the Receiver shall responded with an error.

This procedure is the same as the procedures in clause 10.2.19.3 <contentInstance> RETRIEVE

10.2.23.2 Delete <oldest>

This procedure shall apply to the oldest <contentInstance> resource among all existing <contentInstance> resources in the parent <container> resource. If there is no <contentInstance> resource in the parent, then the Receiver shall responded with an error.

After deletion, the <oldest> contentInstance will point to the oldest <contentInstance> among all remaining <contentInstance> resources in the parent <container> resource.

This procedure is the same as the procedure in as clause 10.2.19.4 <contentInstance> DELETE.

10.2.24 <serviceSubscribedAppRule> Resource Procedures

10.2.24.1 Create <serviceSubscribedAppRule>

This procedure shall be used for creating an <serviceSubscribedAppRule> resource. The information represented in the attributes of a <serviceSubscribedAppRule> resource impacts the Application Entity Registration procedure as outlined in clause 10.1.1.2.2. Instances of <serviceSubscribedAppRule> resources are associated with specific CSEs by linking to them via the ruleLinks attribute of a <serviceSubscribedNode> resource that contains the respective CSE-ID in its CSE-ID attribute.

Table 10.2.24.1-1: <serviceSubscribedAppRule> CREATE

<serviceSubscribedAppRule> CREATE	
Associated Reference Point	Mca and Mcc.
Information in Request message	All parameters defined in table 8.1.2-3 apply with the specific details for: To: The Hosting CSE shall be an IN-CSE. Content: The resource content shall provide the information as defined in clause 9.6.29.
Processing at Originator before sending Request	According to clause 10.1.1.1.
Processing at Receiver	According to clause 10.1.1.1.
Information in Response message	All parameters defined in table 8.1.3-1 apply.
Processing at Originator after receiving Response	According to clause 10.1.1.1.
Exceptions	According to clause 10.1.1.1.

10.2.24.2 Retrieve <serviceSubscribedAppRule>

This procedure shall be used for retrieving the representation of the <serviceSubscribedAppRule> resource.

Table 10.2.24.2-1: <serviceSubscribedAppRule> RETRIEVE

<serviceSubscribedAppRule> RETRIEVE	
Associated Reference Point	Mca, Mcc and Mcc'.
Information in Request message	All parameters defined in table 8.1.2-3 apply with the specific details for: To: The Hosting CSE shall be an IN-CSE. Content: void.
Processing at Originator before sending Request	According to clause 10.1.2.
Processing at Receiver	According to clause 10.1.2.
Information in Response message	All parameters defined in table 8.1.3-1 apply.
Processing at Originator after receiving Response	According to clause 10.1.2.
Exceptions	According to clause 10.1.2.

10.2.24.3 Update <serviceSubscribedAppRule>

This procedure shall be used for updating the attributes of the <serviceSubscribedAppRule> resource.

Table 10.2.24.3-1: <serviceSubscribedAppRule> UPDATE

<serviceSubscribedAppRule> UPDATE	
Associated Reference Point	Mca and Mcc.
Information in Request message	All parameters defined in table 8.1.2-3 apply with the specific details for: To: The Hosting CSE shall be an IN-CSE. Content: Attributes of the <serviceSubscribedAppRule> resource as defined in clause 9.6.29.
Processing at Originator before sending Request	According to clause 10.1.3.
Processing at Receiver	According to clause 10.1.3.
Information in Response message	All parameters defined in table 8.1.3-1 apply.
Processing at Originator after receiving Response	According to clause 10.1.3.
Exceptions	According to clause 10.1.3.

10.2.24.4 Delete <serviceSubscribedAppRule>

This procedure shall be used for deleting the <serviceSubscribedAppRule> resource with all related information.

Table 10.2.24.4-1: <serviceSubscribedAppRule> DELETE

<serviceSubscribedAppRule> DELETE	
Associated Reference Point	Mca and Mcc.
Information in Request message	All parameters defined in table 8.1.2-3 apply with the specific details for: To: The Hosting CSE shall be an IN-CSE.
Processing at Originator before sending Request	According to clause 10.1.4.
Processing at Receiver	According to clause 10.1.4.
Information in Response message	All parameters defined in table 8.1.3-1 apply.
Processing at Originator after receiving Response	According to clause 10.1.4.
Exceptions	According to clause 10.1.4.

10.2.25 <notificationTargetSelfReference> Resource Procedures

10.2.25.0 Overview

Only Delete operations shall be allowed for the <notificationTargetRemove> resource.

10.2.25.1 Delete <notificationTargetSelfReference>

This procedure shall apply to the <subscription> resource . Whenever a Delete Request is received at the <notificationTargetSelfReference> virtual resource from a Notification Target, the Notifier shall handle the request according to the *action* attribute defined in the <notificationTargetPolicy> resource which is linked from the <notificationTargetDisposition> resource. Detailed handling procedure is specified in the clause 10.2.12.2.1 (Notification Target removal handling procedure).

10.2.26 <notificationTargetMgmtPolicyRef> Resource Procedures

10.2.26.1 Create <notificationTargetMgmtPolicyRef>

This procedure shall be used for creating a <notificationTargetMgmtPolicyRef> resource.

Table 10.2.26.1-1: <notificationTargetMgmtPolicyRef> CREATE

<notificationTargetMgmtPolicyRef> CREATE	
Associated Reference Point	Mca, Mcc and Mcc'
Information in Request message	All parameters defined in table 8.1.2-3 apply with the specific details for: Content: The resource content shall provide the information as defined in clause 9.6.6
Processing at Originator before sending Request	According to clause 10.1.1.1
Processing at Receiver	According to clause 10.1.1.1
Information in Response message	According to clause 10.1.1.1
Processing at Originator after receiving Response	According to clause 10.1.1.1
Exceptions	According to clause 10.1.1.1

10.2.26.2 Retrieve <notificationTargetMgmtPolicyRef>

This procedure shall be used for retrieving the attributes of a <notificationTargetMgmtPolicyRef> resource.

Table 10.2.26.2-1: <notificationTargetMgmtPolicyRef> RETRIEVE

<notificationTargetMgmtPolicyRef> RETRIEVE	
Associated Reference Point	Mca, Mcc and Mcc'
Information in Request message	All parameters defined in table 8.1.2-3 apply.
Processing at Originator before sending Request	According to clause 10.1.2
Processing at Receiver	According to clause 10.1.2
Information in Response message	All parameters defined in table 8.1.3-1 apply.
Processing at Originator after receiving Response	According to clause 10.1.2
Exceptions	According to clause 10.1.2

10.2.26.3 Update <notificationTargetMgmtPolicyRef>

This procedure shall be used for updating attributes of a <notificationTargetMgmtPolicyRef> resource.

Table 10.2.26.3-1: <notificationTargetMgmtPolicyRef> UPDATE

<notificationTargetMgmtPolicyRef> UPDATE	
Associated Reference Point	Mca, Mcc and Mcc'
Information in Request message	All parameters defined in table 8.1.2-3 apply
Processing at Originator before sending Request	According to clause 10.1.3
Processing at Receiver	According to clause 10.1.3
Information in Response message	According to clause 10.1.3
Processing at Originator after receiving Response	According to clause 10.1.3
Exceptions	According to clause 10.1.3

10.2.26.4 Delete <notificationTargetMgmtPolicyRef>

This procedure shall be used for deleting a <notificationTargetMgmtPolicyRef> resource.

Table 10.2.26.4-1: <notificationTargetMgmtPolicyRef> DELETE

<notificationTargetMgmtPolicyRef> DELETE	
Associated Reference Point	Mca, Mcc and Mcc'
Information in Request message	All parameters defined in table 8.1.2-3 apply
Processing at Originator before sending Request	According to clause 10.1.4.1
Processing at Receiver	According to clause 10.1.4.1
Information in Response message	According to clause 10.1.4.1
Processing at Originator after receiving Response	According to clause 10.1.4.1
Exceptions	According to clause 10.1.4.1

10.2.27 <notificationTargetPolicy> Resource Procedures

10.2.27.1 Create <notificationTargetPolicy>

This procedure shall be used for creating a <notificationTargetPolicy> resource.

Table 10.2.27.1-1: <notificationTargetPolicy> CREATE

<notificationTargetPolicy> CREATE	
Associated Reference Point	Mca, Mcc and Mcc'
Information in Request message	All parameters defined in table 8.1.2-3 apply with the specific details for: Content: The resource content shall provide the information as defined in clause 9.6.6
Processing at Originator before sending Request	According to clause 10.1.1.1
Processing at Receiver	According to clause 10.1.1.1
Information in Response message	According to clause 10.1.1.1
Processing at Originator after receiving Response	According to clause 10.1.1.1
Exceptions	According to clause 10.1.1.1

10.2.27.2 Retrieve <notificationTargetPolicy>

This procedure shall be used for retrieving the attributes of a <notificationTargetPolicy> resource.

Table 10.2.27.2-1: <notificationTargetPolicy> RETRIEVE

<notificationTargetPolicy> RETRIEVE	
Associated Reference Point	Mca, Mcc and Mcc'
Information in Request message	All parameters defined in table 8.1.2-3 apply
Processing at Originator before sending Request	According to clause 10.1.2
Processing at Receiver	According to clause 10.1.2
Information in Response message	All parameters defined in table 8.1.3-1 apply
Processing at Originator after receiving Response	According to clause 10.1.2
Exceptions	According to clause 10.1.2

10.2.27.3 Update <notificationTargetPolicy>

This procedure shall be used for updating attributes of a <notificationTargetPolicy> resource.

Table 10.2.27.3-1: <notificationTargetPolicy> UPDATE

<notificationTargetPolicy> UPDATE	
Associated Reference Point	Mca, Mcc and Mcc'
Information in Request message	All parameters defined in table 8.1.2-3 apply
Processing at Originator before sending Request	According to clause 10.1.3
Processing at Receiver	According to clause 10.1.3
Information in Response message	According to clause 10.1.3
Processing at Originator after receiving Response	According to clause 10.1.3
Exceptions	According to clause 10.1.3

10.2.27.4 Delete <notificationTargetPolicy>

This procedure shall be used for deleting a <notificationTargetPolicy> resource.

Table 10.2.27.4-1: <notificationTargetPolicy> DELETE

<notificationTargetPolicy> DELETE	
Associated Reference Point	Mca, Mcc and Mcc'
Information in Request message	All parameters defined in table 8.1.2-3 apply
Processing at Originator before sending Request	According to clause 10.1.4.1
Processing at Receiver	According to clause 10.1.4.1
Information in Response message	According to clause 10.1.4.1
Processing at Originator after receiving Response	According to clause 10.1.4.1
Exceptions	According to clause 10.1.4.1

10.2.28 <policyDeletionRules> Resource Procedures

10.2.28.1 Create <policyDeletionRules>

This procedure shall be used for creating a <policyDeletionRules> resource.

Table 10.2.28.1-1: <policyDeletionRules> CREATE

<policyDeletionRules> CREATE	
Associated Reference Point	Mca, Mcc and Mcc'
Information in Request message	All parameters defined in table 8.1.2-3 apply with the specific details for: Content: The resource content shall provide the information as defined in clause 9.6.6
Processing at Originator before sending Request	According to clause 10.1.1.1
Processing at Receiver	According to clause 10.1.1.1
Information in Response message	According to clause 10.1.1.1
Processing at Originator after receiving Response	According to clause 10.1.1.1
Exceptions	According to clause 10.1.1.1

10.2.28.2 Retrieve <policyDeletionRules>

This procedure shall be used for retrieving the attributes of a <policyDeletionRules> resource.

Table 10.2.28.2-1: <policyDeletionRules> RETRIEVE

<policyDeletionRules> RETRIEVE	
Associated Reference Point	Mca, Mcc and Mcc'
Information in Request message	All parameters defined in table 8.1.2-3 apply
Processing at Originator before sending Request	According to clause 10.1.2
Processing at Receiver	According to clause 10.1.2
Information in Response message	All parameters defined in table 8.1.3-1 apply
Processing at Originator after receiving Response	According to clause 10.1.2
Exceptions	According to clause 10.1.2

10.2.28.3 Update <policyDeletionRules>

This procedure shall be used for updating attributes of a <policyDeletionRules> resource.

Table 10.2.28.3-1: <policyDeletionRules> UPDATE

<poiiicyDeletionRules> UPDATE	
Associated Reference Point	Mca, Mcc and Mcc'
Information in Request message	All parameters defined in table 8.1.2-3 apply
Processing at Originator before sending Request	According to clause 10.1.3
Processing at Receiver	According to clause 10.1.3
Information in Response message	According to clause 10.1.3
Processing at Originator after receiving Response	According to clause 10.1.3
Exceptions	According to clause 10.1.3

10.2.28.4 Delete <policyDeletionRules>

This procedure shall be used for deleting a <policyDeletionRules> resource.

Table 10.2.28.4-1: <policyDeletionRules> DELETE

<policyDeletionRules> DELETE	
Associated Reference Point	Mca, Mcc and Mcc'
Information in Request message	All parameters defined in table 8.1.2-3 apply
Processing at Originator before sending Request	According to clause 10.1.4.1
Processing at Receiver	According to clause 10.1.4.1
Information in Response message	According to clause 10.1.4.1
Processing at Originator after receiving Response	According to clause 10.1.4.1
Exceptions	According to clause 10.1.4.1

10.2.29 <flexContainer> Resource Procedures

10.2.29.1 Create <flexContainer>

This procedure shall be used for creating a <flexContainer> resource.

Table 10.2.29.1-1: <flexContainer> CREATE

<flexContainer> CREATE	
Associated Reference Point	Mca, Mcc and Mcc'
Information in Request message	According to clause 10.1.1.1
Processing at Originator before sending Request	According to clause 10.1.1.1
Processing at Receiver	According to clause 10.1.1.1
Information in Response message	All parameters defined in table 8.1.3-1 apply with the specific details for: Content: Address of the created <flexContainer> resource, according to clause 10.1.1.1
Processing at Originator after receiving Response	According to clause 10.1.1.1
Exceptions	According to clause 10.1.1.1 with the following addition: <ul style="list-style-type: none"> The parent resource type of this newly created <flexContainer> resource shall follow the definition in clause 9.6.1.2.2 (Specializations of <flexContainer>)

10.2.29.2 Retrieve <flexContainer>

This procedure shall be used for retrieving the attributes of a <flexContainer> resource.

Table 10.2.29.2-1: <flexContainer> RETRIEVE

<flexContainer> RETRIEVE	
Associated Reference Point	Mca, Mcc and Mcc'
Information in Request message	All parameters defined in table 8.1.2-2 apply with the specific details for: Content: void
Processing at Originator before sending Request	According to clause 10.1.2
Processing at Receiver	According to clause 10.1.2
Information in Response message	All parameters defined in table 8.1.3-1 apply with the specific details for: Content: attributes of the <flexContainer> resource as defined in clause 9.6.6
Processing at Originator after receiving Response	According to clause 10.1.2
Exceptions	According to clause 10.1.2

10.2.29.3 Update <flexContainer>

This procedure shall be used for updating the attributes and the actual data of a <flexContainer> resource.

Table 10.2.29.3-1: <flexContainer> UPDATE

<flexContainer> UPDATE	
Associated Reference Point	Mca, Mcc and Mcc'
Information in Request message	All parameters defined in table 8.1.2-2 apply with the specific details for: Content: attributes of the <flexContainer> resource as defined in clause 9.6.6 which need be updated
Processing at Originator before sending Request	According to clause 10.1.3
Processing at Receiver	According to clause 10.1.3
Information in Response message	According to clause 10.1.3
Processing at Originator after receiving Response	According to clause 10.1.3
Exceptions	According to clause 10.1.3

10.2.29.4 Delete <flexContainer>

This procedure shall be used for deleting a <flexContainer> resource.

Table 10.2.29.4-1: <flexContainer> DELETE

<flexContainer> DELETE	
Associated Reference Point	Mca, Mcc and Mcc'
Information in Request message	All parameters defined in table 8.1.2-2 apply
Processing at Originator before sending Request	According to clause 10.1.4.1
Processing at Receiver	According to clause 10.1.4.1
Information in Response message	According to clause 10.1.4.1
Processing at Originator after receiving Response	According to clause 10.1.4.1
Exceptions	According to clause 10.1.4.1

10.2.30 <timeSeries> Resource Procedures

10.2.30.1 Create <timeSeries>

This procedure shall be used for creating a <timeSeries> resource.

Table 10.2.30.1-1: <timeSeries> CREATE

<timeSeries> CREATE	
Associated Reference Point	Mca, Mcc and Mcc'
Information in Request message	All parameters defined in table 8.1.2-2 apply with the specific details for: Content: The resource content shall provide the information as defined in clause 9.6.36
Processing at Originator before sending Request	According to clause 10.1.1.1
Processing at Receiver	According to clause 10.1.1.1: <ul style="list-style-type: none"> Conditionally, in the case that the <i>periodicInterval</i> are set and the <i>missingDataDetect</i> is TRUE, the Hosting CSE shall monitor the Time Series Data based on its <i>periodicallIntervalater</i>
Information in Response message	All parameters defined in table 8.1.3-1 apply with the specific details for: Content: Address of the created <timeSeries> resource, according to clause 10.1.1.1
Processing at Originator after receiving Response	According to clause 10.1.1.1
Exceptions	According to clause 10.1.1.1

10.2.30.2 Retrieve <timeSeries>

This procedure shall be used for retrieving the attributes of a <timeSeries> resource.

Table 10.2.30.2-1: <timeSeries> RETRIEVE

<timeSeries> RETRIEVE	
Associated Reference Point	Mca, Mcc and Mcc'
Information in Request message	All parameters defined in table 8.1.2-2 apply with the specific details for: Content: void
Processing at Originator before sending Request	According to clause 10.1.2
Processing at Receiver	According to clause 10.1.2
Information in Response message	All parameters defined in table 8.1.3-1 apply with the specific details for: Content: attributes of the <timeSeries> resource as defined in clause 9.6.36
Processing at Originator after receiving Response	According to clause 10.1.2
Exceptions	According to clause 10.1.2

10.2.30.3 Update <timeSeries>

This procedure shall be used for updating the attributes in a <timeSeries> resource.

Table 10.2.30.3-1: <timeSeries> UPDATE

< timeSeries > UPDATE	
Associated Reference Point	Mca, Mcc and Mcc'
Information in Request message	All parameters defined in table 8.1.2-2 apply with the specific details for: Content: attributes of the <timeSeries> resource as defined in clause 9.6.36 which need be updated
Processing at Originator before sending Request	According to clause 10.1.3
Processing at Receiver	According to clause 10.1.3
Information in Response message	According to clause 10.1.3
Processing at Originator after receiving Response	According to clause 10.1.3
Exceptions	According to clause 10.1.3

10.2.30.4 Delete <timeSeries>

This procedure shall be used for deleting a <timeSeries> resource residing under a <timeSeries> resource.

Table 10.2.30.4-1: <timeSeries> DELETE

<timeSeries> DELETE	
Associated Reference Point	Mca, Mcc and Mcc'.
Information in Request message	All parameters defined in table 8.1.2-2 apply.
Processing at Originator before sending Request	According to clause 10.1.4.1.
Processing at Receiver	According to clause 10.1.4.1.
Information in Response message	According to clause 10.1.4.1.
Processing at Originator after receiving Response	According to clause 10.1.4.1.
Exceptions	According to clause 10.1.4.1.

10.2.31 <timeSeriesInstance> Resource Procedures

10.2.31.1 Create <timeSeriesInstance>

This procedures shall be used for creating a <timeSeriesInstane> resource.

Table 10.2.31.1-1: <timeSeriesInstance> CREATE

<timeSeriesInstance> CREATE	
Associated Reference Point	Mca, Mcc and Mcc'.
Information in Request message	All parameters defined in table 8.1.2-2 apply with the specific details for: Content: The resource content shall provide the information as defined in clause 9.6.37.
Processing at Originator before sending Request	According to clause 10.1.1.1.
Processing at Receiver	According to clause 10.1.1.1. If the newly created <timeSeriesInstance> resource violates any of the policies defined in the parent <timeSeries> resource (i.e. <i>maxInstanceAge</i> , <i>maxNrOfInstances</i> or <i>maxByteSize</i>), then the <timeSeriesInstance> resource with the oldest <i>dataGenerationTime</i> attribute shall be removed to enable the creation of the new <timeSeriesInstance> resource. The Create Request of the other entities except the <i>creator</i> , shall be rejected.
Information in Response message	All parameters defined in table 8.1.3-1 apply with the specific details for: Content: Address of the created <timeSeriesInstance> resource, according to clause 10.1.1.1.
Processing at Originator after receiving Response	According to clause 10.1.1.1.
Exceptions	According to clause 10.1.1.1.

10.2.31.2 Retrieve <timeSeriesInstance>

This procedure shall be used for retrieving the attributes of a <timeSeriesInstance> resource.

Table 10.2.31.3-1: <timeSeriesInstance> RETRIEVE

<timeSeriesInstance> RETRIEVE	
Associated Reference Point	Mca, Mcc and Mcc'.
Information in Request message	According to clause 10.1.2.
Processing at Originator before sending Request	According to clause 10.1.2.
Processing at Receiver	According to clause 10.1.2.
Information in Response message	According to clause 10.1.2.
Processing at Originator after receiving Response	According to clause 10.1.2.
Exceptions	According to clause 10.1.2.

10.2.31.3 Update <timeSeriesInstance>

The Update operation shall not apply to <timeSeriesInstance> resource.

10.2.31.4 Delete <timeSeriesInstance>

This procedure shall be used for deleting a <timeSeriesInstance> resource residing under a <timeSeries> resource.

Table 10.2.31.5-1: <timeSeriesInstance> DELETE

<timeSeriesInstance> DELETE	
Associated Reference Point	Mca, Mcc and Mcc'.
Information in Request message	All parameters defined in table 8.1.2-2 apply.
Processing at Originator before sending Request	According to clause 10.1.4.
Processing at Receiver	According to clause 10.1.4.
Information in Response message	According to clause 10.1.4.
Processing at Originator after receiving Response	According to clause 10.1.4.
Exceptions	According to clause 10.1.4.

10.2.32 <semanticDescriptor> Resource Procedures

10.2.32.1 Create <semanticDescriptor>

This procedure shall be used for creating a <semanticDescriptor > resource.

Table 10.2.32.1-1: <semanticDescriptor> CREATE

<semanticDescriptor> CREATE	
Associated Reference Point	Mca, Mcc and Mcc'
Information in Request message	All parameters defined in table 8.1.2-2 apply with the specific details for: Content: The resource content shall provide the information as defined in clause 9.6.30
Processing at Originator before sending Request	According to clause 10.1.1.1
Processing at Receiver	According to clause 10.1.1.1
Information in Response message	According to clause 10.1.1.1
Processing at Originator after receiving Response	According to clause 10.1.1.1
Exceptions	According to clause 10.1.1.1

10.2.32.2 Retrieve <semanticDescriptor>

This procedure shall be used for retrieving the attributes of a <semanticDescriptor> resource.

Table 10.2.32.2-1: <semanticDescriptor> RETRIEVE

<semanticDescriptor > RETRIEVE	
Associated Reference Point	Mca, Mcc and Mcc'.
Information in Request message	All parameters defined in table 8.1.2-2.
Processing at Originator before sending Request	According to clause 10.1.2.
Processing at Receiver	According to clause 10.1.2.
Information in Response message	All parameters defined in table 8.1.3-1 apply.
Processing at Originator after receiving Response	According to clause 10.1.2.
Exceptions	According to clause 10.1.2.

10.2.32.3 Update <semanticDescriptor>

This procedure shall be used for updating attributes of a <semanticDescriptor > resource.

Table 10.2.32.3-1: <semanticDescriptor> UPDATE

<semanticDescriptor> UPDATE	
Associated Reference Point	Mca, Mcc and Mcc'
Information in Request message	All parameters defined in table 8.1.2-2 apply with the specific details for: Content: 1) full representation of the descriptor attribute 2) partial representation of the descriptor attribute are defined with SPARQL statements that shall be specified in the SPARQL query language [5]
Processing at Originator before sending Request	According to clause 10.1.3
Processing at Receiver	According to clause 10.1.3
Information in Response message	According to clause 10.1.3
Processing at Originator after receiving Response	According to clause 10.1.3
Exceptions	According to clause 10.1.3

10.2.32.4 Delete <semanticDescriptor>

This procedure shall be used for deleting a <semanticDescriptor> resource.

Table 10.2.32.4-1: <semanticDescriptor> DELETE

<semanticDescriptor> DELETE	
Associated Reference Point	Mca, Mcc and Mcc'
Information in Request message	All parameters defined in table 8.1.2-2 apply
Processing at Originator before sending Request	According to clause 10.1.4.1
Processing at Receiver	According to clause 10.1.4.1
Information in Response message	According to clause 10.1.4.1
Processing at Originator after receiving Response	According to clause 10.1.4.1
Exceptions	According to clause 10.1.4.1

10.2.33 <role> Resource Procedures

10.2.33.1 Create <role>

This procedure shall be used for creating a <role> resource.

Table 10.2.33.1-1: <role> CREATE

<role> CREATE	
Associated Reference Point	Mca, Mcc and Mcc'
Information in Request message	All parameters defined in table 8.1.2-3 apply with the specific details for: From: Identifier of the AE that initiates the request To: Address the resource where the <role> resource is intended to be created Content: The resource content shall provide the information as defined in clause 9.6.38
Processing at Originator before sending Request	According to clause 10.1.1.1
Processing at Receiver	According to clause 10.1.1.1
Information in Response message	All parameters defined in table 8.1.3-1 apply with the specific details for: Content: Address of the created <role> resource, according to clause 10.1.1.1
Processing at Originator after receiving Response	According to clause 10.1.1.1
Exceptions	According to clause 10.1.1.1

10.2.33.2 Retrieve <role>

This procedure shall be used for retrieving the attributes of a <role> resource.

Table 10.2.33.2-1: <role> RETRIEVE

<role> RETRIEVE	
Associated Reference Point	Mca, Mcc and Mcc'
Information in Request message	All parameters defined in table 8.1.2-3 apply with the specific details for: Content: void
Processing at Originator before sending Request	According to clause 10.1.2
Processing at Receiver	According to clause 10.1.2
Information in Response message	All parameters defined in table 8.1.3-1 apply with the specific details for: Content: attributes of the <role> resource as defined in clause 9.6.38
Processing at Originator after receiving Response	According to clause 10.1.2
Exceptions	According to clause 10.1.2

10.2.33.3 Update <role>

This procedure shall be used for updating attributes of a <role> resource.

Table 10.2.33.3-1: <role> UPDATE

<role> UPDATE	
Associated Reference Point	Mca, Mcc and Mcc'
Information in Request message	All parameters defined in table 8.1.2-3 apply
Processing at Originator before sending Request	According to clause 10.1.3
Processing at Receiver	According to clause 10.1.3
Information in Response message	According to clause 10.1.3
Processing at Originator after receiving Response	According to clause 10.1.3
Exceptions	According to clause 10.1.3

10.2.33.4 Delete <role>

This procedure shall be used for deleting an existing <role> resource.

Table 10.2.33.4-1: <role> DELETE

<role> DELETE	
Associated Reference Point	Mca, Mcc and Mcc'
Information in Request message	All parameters defined in table 8.1.2-3 apply
Processing at Originator before sending Request	According to clause 10.1.4.1
Processing at Receiver	According to clause 10.1.4.1
Information in Response message	According to clause 10.1.4.1
Processing at Originator after receiving Response	According to clause 10.1.4.1
Exceptions	According to clause 10.1.4.1

10.2.34 <token> Resource Procedures

10.2.34.1 Create <token>

This procedure shall be used for creating a <token> resource.

Table 10.2.34.1-1: <token> CREATE

<token> CREATE	
Associated Reference Point	Mca, Mcc and Mcc'
Information in Request message	All parameters defined in table 8.1.2-3 apply with the specific details for: From: Identifier of the AE that initiates the request To: Address the resource where the <token> resource is intended to be created Content: The resource content shall provide the information as defined in clause 9.6.39
Processing at Originator before sending Request	According to clause 10.1.1.1
Processing at Receiver	According to clause 10.1.1.1
Information in Response message	All parameters defined in table 8.1.3-1 apply with the specific details for: Content: Address of the created <token> resource, according to clause 10.1.1.1
Processing at Originator after receiving Response	According to clause 10.1.1.1
Exceptions	According to clause 10.1.1.1

10.2.34.2 Retrieve <token>

This procedure shall be used for retrieving the attributes of a <token> resource.

Table 10.2.34.2-1: <token> RETRIEVE

<token> RETRIEVE	
Associated Reference Point	Mca, Mcc and Mcc'
Information in Request message	All parameters defined in table 8.1.2-3 apply with the specific details for: Content: void
Processing at Originator before sending Request	According to clause 10.1.2
Processing at Receiver	According to clause 10.1.2
Information in Response message	All parameters defined in table 8.1.3-1 apply with the specific details for: Content: attributes of the <token> resource as defined in clause 9.6.39
Processing at Originator after receiving Response	According to clause 10.1.2
Exceptions	According to clause 10.1.2

10.2.34.3 Update <token>

This procedure shall be used for updating attributes of a <token> resource.

Table 10.2.34.3-1: <token> UPDATE

<token> UPDATE	
Associated Reference Point	Mca, Mcc and Mcc'
Information in Request message	All parameters defined in table 8.1.2-3 apply
Processing at Originator before sending Request	According to clause 10.1.3
Processing at Receiver	According to clause 10.1.3
Information in Response message	According to clause 10.1.3
Processing at Originator after receiving Response	According to clause 10.1.3
Exceptions	According to clause 10.1.3

10.2.34.4 Delete <token>

This procedure shall be used for deleting an existing <token> resource.

Table 10.2.34.4-1: <token> DELETE

<token> DELETE	
Associated Reference Point	Mca, Mcc and Mcc'
Information in Request message	All parameters defined in table 8.1.2-3 apply
Processing at Originator before sending Request	According to clause 10.1.4.1
Processing at Receiver	According to clause 10.1.4.1
Information in Response message	According to clause 10.1.4.1
Processing at Originator after receiving Response	According to clause 10.1.4.1
Exceptions	According to clause 10.1.4.1

10.2.35 Semantic Discovery Procedures

10.2.35.1 Introduction

This clause describes semantic discovery procedures on semantic descriptions represented as RDF triples, given that an overall semantic description (logical tree) may be distributed across several *<semanticDescriptor>* resources.

Semantic discovery procedures may be performed using RETRIEVE operations as follows:

Targeting any resource other than *<semanticFanOutPoint>*:

- The receiver begins processing the request by retrieving the *<semanticDescriptor>* resource of the request target and its *descriptor* attribute. Related descriptors are discovered and accessed according to clause 10.2.35.2. The content of related *descriptor* attributes are added to the content on which the SPARQL request is being executed. Depending on which of the options described in clauses 10.2.35.2.1 or 10.2.35.2.2 is chosen, all potentially relevant *descriptor* attributes are added before executing the SPARQL request or they are added when needed during the execution of the SPARQL request.
- The resulting content subject to the SPARQL request is provided to the SPARQL engine for processing.

Targeting a *<semanticFanOutPoint>* resource (see also clauses 10.2.7.14):

- In this case the related descriptors are the members of the *<group>* resource parent of the targeted *<semanticFanOutPoint>*. Based on the *memberID* attribute of the parent *<group>* resource all the related descriptors are discovered, and those on the *<group>* hosting CSE are retrieved together.
- If there are descriptors stored on a different CSE, individual RETRIEVE requests are sent to each CSE for retrieving the external descriptors.
- All semantic descriptors are retrieved based on the respective access control policies.
- Once all of the related *<semanticDescriptor>*(s) have been accessed, the content of each of the descriptor attribute is added to the content on which the SPARQL request is being executed.
- The full/enlarged content subject to the SPARQL request is provided to the SPARQL engine for processing.

10.2.35.2 Discovering and establishing the logical tree in the semantic discovery scope without the use of *<semanticFanOutPoint>*

10.2.35.2.0 Overview

Given that an overall semantic description (logical tree) may be distributed across the *<semanticDescriptor>* resources, there are two methods of constructing the logical tree in the scope of a semantic discovery targeting any resource other than *<semanticFanOutPoint>*:

- If the attribute *relatedSemantics* is empty or does not exist, the "Annotation-based method" (using *resourceDescriptorLink*) detailed in clause 10.2.35.2.1 shall be used.
- If the attribute *relatedSemantics* is not empty the "Resource link-based method" (using *relatedSemantics*) detailed in clause 10.2.35.2.2 shall be used.

10.2.35.2.1 Annotation-based method

In this option, the links to related *<semanticDescriptor>* resources are encoded in the semantic description itself, which is encoded as RDF triples [4] logically structured as *<subject> <predicate> <object>*. For this purpose, an annotation property called *onem2m:resourceDescriptorLink* is introduced. It is formally specified as part of the oneM2M Base Ontology defined in [6] and can be used as a predicate in any RDF triple with any subject and without further relation to the oneM2M Base Ontology. Only the use of the *onem2m* namespace is required to uniquely identify the annotation property.

Whenever further information about a semantic instance $\langle X \rangle$ is stored in another $\langle \text{semanticDescriptor} \rangle$ resource, a new RDF triple $\langle X \rangle \text{ onem2m:resourceDescriptorLink } \langle \text{SemanticDescriptorURL} \rangle$ may be added to this semantic description, where $\langle \text{SemanticDescriptorURL} \rangle$ is the URL of the other *semanticDescriptor* resource containing additional information related to $\langle X \rangle$. If multiple $\langle \text{semanticDescriptor} \rangle$ resources contain relevant further information, these can be added to a $\langle \text{group} \rangle$ resource and the $\langle \text{SemanticDescriptorURL} \rangle$ then refers to the virtual $\langle \text{fanOutPoint} \rangle$ resource of this group, which will be used for retrieving the aggregated information.

NOTE: The RDF triple syntax in this paragraph is only used for illustration purposes. The actual encoding of the RDF triples used in oneM2M is defined in oneM2M TS-0004 [3].

To make use of the *onem2m:resourceDescriptorLink* property, the evaluation of semantic queries formulated as SPARQL requests by the SPARQL engine has to be adapted in the following way:

- The SPARQL request is executed on the content of the semantic description in the *descriptor* attribute of the *semanticDescriptor* resource.
- For each semantic instance matched in the SPARQL request, it is checked whether one or more *onem2m:resourceDescriptorLink* annotations exist.
- If this is the case, the execution of the SPARQL request is halted.
- The content of the descriptor attribute of each of the *semanticDescriptor* resources referenced by the *onem2m:semanticDescriptorLink* annotations is added to the content on which the SPARQL request is being executed. If the *onem2m:semanticDescriptorLink* annotation references a group, the additional *descriptor* content is accessed by performing a retrieve request to the virtual $\langle \text{fanOutPoint} \rangle$ resource referenced.
- The execution of the SPARQL request is continued on the enlarged content.

10.2.35.2.2 Resource link-based method

In this option, the links to related $\langle \text{semanticDescriptor} \rangle$ resources are specified in the *relatedSemantics* attribute.

Processing of the SPARQL engine procedures at the receiver:

- The receiver retrieves the $\langle \text{semanticDescriptor} \rangle$ resource of the request target.
- Based on the *relatedSemantics* attribute of the $\langle \text{semanticDescriptor} \rangle$ resource targeted, all the related descriptors are discovered, as follows:
 - If the *relatedSemantics* attribute includes a list of links, each of the linked Descriptors are accessed based on the respective access control policies.
 - If the *relatedSemantics* points to a $\langle \text{group} \rangle$ resource, the group members from the *memberID* attribute are used and each of their $\langle \text{semanticDescriptor} \rangle$ (s) are accessed based on the respective access control policies.
- Once all of the related $\langle \text{semanticDescriptor} \rangle$ (s) have been accessed, the content of each of the descriptor attribute is added to the content on which the SPARQL request is being executed.
- The full/enlarged content subject to the SPARQL request is provided to the SPARQL engine for processing.

10.2.36 Void

10.2.37 $\langle \text{trafficPattern} \rangle$ Resource Procedures

10.2.37.1 Create $\langle \text{trafficPattern} \rangle$

This procedure shall be used for creating a $\langle \text{trafficPattern} \rangle$ resource.

Table 10.2.37.1-1: <trafficPattern> CREATE

<trafficPattern> CREATE	
Associated Reference Point	Mca, Mcc and Mcc'
Information in Request message	All parameters defined in table 8.1.2-3 apply with the specific details for: Content: The resource content shall provide the information as defined in clause 9.6.41
Processing at Originator before sending Request	According to clause 10.1.1.1
Processing at Receiver	According to clause 10.1.1.1 with the following modifications: When checking validity of the request the hosting CSE can include a check of consistency with <schedule> resources (see note 1) The CSE shall: <ul style="list-style-type: none"> • Select a NSE of the target Network for which the traffic pattern is applicable to request for the configuration of the TP parameter sets to Underlying Network, (see note 2) • The CSE shall send a request to provide TP parameter sets for the Field Domain Node to the NSE, using the appropriate Mcn protocol Upon receipt of a successful response to that request the CSE shall UPDATE the <i>providedToNSE</i> attribute of the <trafficPattern> resource with the value TRUE Upon receipt of a unsuccessful response to that request the CSE shall UPDATE the <i>providedToNSE</i> attribute of the <trafficPattern> resource with the value FALSE
Information in Response message	According to clause 10.1.1.1
Processing at Originator after receiving Response	According to clause 10.1.1.1
Exceptions	According to clause 10.1.1.1
<p>NOTE 1: The validation check of the request from the Originator can include:</p> <ul style="list-style-type: none"> - Consistency with traffic patterns of AEs residing on the entity (ASN, ADN, MN) of that Node. - Consistency with other network related schedules of this Node (e.g. contained in the <schedule> resource pointed at by the <i>mgmtLink</i> attribute of a <cmdhNwAccessRule> resource of the Node). - If several TP parameter sets exist for one Field Domain Node, then ensure that the schedules of the different TP parameter sets for a particular target network are not overlapping. <p>NOTE 2: In the case of a 3GPP network the correct NSE can be found by following of a chain of links of multiple resources in the IN-CSE, e.g. the <node> resource having the <i>hostedCSELink</i> linking to the <remoteCSE> resource having the M2M-Ext-ID linking to the UNetwork-ID of the NSE (see clauses 7.1.8 and 7.1.9).</p>	

10.2.37.2 Retrieve <trafficPattern>

This procedure shall be used for retrieving the attributes of a <trafficPattern> resource.

Table 10.2.37.2-1: <trafficPattern> RETRIEVE

<trafficPattern> RETRIEVE	
Associated Reference Point	Mca, Mcc and Mcc'
Information in Request message	All parameters defined in table 8.1.2-3 apply
Processing at Originator before sending Request	According to clause 10.1.2
Processing at Receiver	According to clause 10.1.2
Information in Response message	All parameters defined in table 8.1.3-1 apply
Processing at Originator after receiving Response	According to clause 10.1.2
Exceptions	According to clause 10.1.2

10.2.37.3 Update <trafficPattern>

This procedure shall be used for updating attributes of a <trafficPattern> resource.

Table 10.2.37.3-1: <trafficPattern> UPDATE

<trafficPattern> UPDATE	
Associated Reference Point	Mca, Mcc and Mcc'
Information in Request message	All parameters defined in table 8.1.2-3 apply
Processing at Originator before sending Request	According to clause 10.1.3
Processing at Receiver	<p>According to clause 10.1.3 with the following modifications: When checking validity of the request the hosting CSE can include a check of consistency with <schedule> resources (see note)</p> <p>The CSE shall:</p> <ul style="list-style-type: none"> • Select a NSE of the target Network for which the traffic pattern is applicable • Send a request to delete the previous TP parameter sets for the Field Domain Node to the NSE, using the appropriate Mcn protocol • Send a request to provide the new TP parameter sets for the Field Domain Node to the NSE, using the appropriate Mcn protocol <p>Upon receipt of a successful response to that request the CSE shall UPDATE the <i>providedToNSE</i> attribute of the <trafficPattern> resource with the value TRUE Upon receipt of a unsuccessful response to that request the CSE shall UPDATE the <i>providedToNSE</i> attribute of the <trafficPattern> resource with the value FALSE</p>
Information in Response message	According to clause 10.1.3
Processing at Originator after receiving Response	According to clause 10.1.3
Exceptions	According to clause 10.1.3
NOTE:	<p>The validation check of the request from the Originator can include:</p> <ul style="list-style-type: none"> - Consistency with traffic patterns of AEs residing on the entity (ASN, ADN, MN) of that Node. - Consistency with other network related schedules of this Node (e.g. contained in the <schedule> resource pointed at by the <i>mgmtLink</i> attribute of a <cmdhNwAccessRule> resource of the Node). - If several TP parameter sets exist for one Field Domain Node, then ensure that the schedules of the different TP parameter sets for a particular target network are not overlapping.

10.2.37.4 Delete <trafficPattern>

This procedure shall be used for deleting a <trafficPattern> resource.

Table 10.2.37.4-1: <trafficPattern> DELETE

<trafficPattern> DELETE	
Associated Reference Point	Mca, Mcc and Mcc'
Information in Request message	All parameters defined in table 8.1.2-3 apply
Processing at Originator before sending Request	According to clause 10.1.4.1
Processing at Receiver	<p>According to clause 10.1.4.1 with the following modifications: The CSE shall:</p> <ul style="list-style-type: none"> - Select a NSE of the target Network for which the traffic pattern is applicable <p>Send a request to delete the previous TP parameter sets for the field domain node to the NSE, using the appropriate Mcn protocol</p>
Information in Response message	According to clause 10.1.4.1
Processing at Originator after receiving Response	According to clause 10.1.4.1
Exceptions	According to clause 10.1.4.1

10.2.38 <dynamicAuthorizationConsultation> Resource Procedures

10.2.38.1 Create <dynamicAuthorizationConsultation>

This procedure shall be used to create a <dynamicAuthorizationConsultation> resource.

Table 10.2.38.1-1: <dynamicAuthorizationConsultation> CREATE

<dynamicAuthorizationConsultation> CREATE	
Associated Reference Point	Mca, Mcc and Mcc'.
Information in Request message	Same as clause 10.1.1.
Pre-Processing at Originator	Same as clause 10.1.1.
Processing at Receiver	Same as clause 10.1.1.
Information in Response message	Same as clause 10.1.1.
Post-Processing at Originator	Same as clause 10.1.1.
Exceptions	Same as clause 10.1.1.

10.2.38.2 Retrieve <dynamicAuthorizationConsultation>

This procedure shall be used to retrieve attributes and child resource information of the <dynamicAuthorizationConsultation> resource.

Table 10.2.38.2-1: <dynamicAuthorizationConsultation> RETRIEVE

<dynamicAuthorizationConsultation> RETRIEVE	
Associated Reference Point	Mca, Mcc and Mcc'.
Information in Request message	Same as clause 10.1.2.
Pre-Processing at Originator	Same as clause 10.1.2.
Processing at Receiver	Same as clause 10.1.2.
Information in Response message	Same as clause 10.1.2.
Post-Processing at Originator	Same as clause 10.1.2.
Exceptions	Addition to clause 10.1.2.

10.2.38.3 Update <dynamicAuthorizationConsultation>

This procedure shall be used to update attributes information of the <dynamicAuthorizationConsultation> resource.

Table 10.2.38.3-1: <dynamicAuthorizationConsultation> UPDATE

<dynamicAuthorizationConsultation> UPDATE	
Associated Reference Point	Mca, Mcc and Mcc'.
Information in Request message	Same as clause 10.1.3.
Pre-Processing at Originator	Same as clause 10.1.3.
Processing at Receiver	Addition to clause 10.1.3.
Information in Response message	Same as clause 10.1.3.
Post-Processing at Originator	Same as clause 10.1.3.
Exceptions	Addition to clause 10.1.3.

10.2.38.4 Delete <dynamicAuthorizationConsultation>

This procedure shall be used to delete the <dynamicAuthorizationConsultation> resource.

Table 10.2.38.4-1: <dynamicAuthorizationConsultation> DELETE

<dynamicAuthorizationConsultation> DELETE	
Associated Reference Point	Mca, Mcc and Mcc'.
Information in Request message	Same as clause 10.1.4.
Pre-Processing at Originator	Same as clause 10.1.4.
Processing at Receiver	Addition to clause 10.1.4.
Information in Response message	Same as clause 10.1.4.
Post-Processing at Originator	Same as clause 10.1.4.
Exceptions	Addition to clause 10.1.4.

10.2.39 Procedure for Time Series Data Detecting and Reporting

In the case that the *periodicInterval* is set and the *missingDataDetect* is TRUE, the Hosting CSE shall monitor the Time Series Data based on its *periodicalInterval*. When the Hosting CSE detects a missing data point, the *dataGenerationTime* of the missing data point is inserted into the *missingDataList* attribute and the *missingDataCurrentNr* shall be increased by one. When the *missingDataCurrentNr* reaches the *missingDataMaxNr*, the oldest *dataGenerationTime* shall be removed from *missingDataList* to enable the insertion of the new missing data point information.

When an AE wants to be informed of the number of missing data points in a given renewable time duration, the AE should request the creation of a <subscription> resource and set the *missingData* in the *eventNotificationCriteria* conditions to specify the reporting policy. This enables the AE to keep track of the number of missing data points and the corresponding time-stamps over a predefined but renewable duration (i.e. the "window duration" of the *missingData condition*).

When the Hosting CSE reports missing data points, it shall check the *missingData* condition in the applicable subscription resource created by the AE for that purpose.

When the first missing data point is detected (i.e. a detection of the first discontinuous time-stamp), following the creation of the subscription, the Hosting CSE shall start a timer, and keep counting the number of the missing data points. The timer is set according to the "window duration" in the *missingData* condition. The reporting policy is governed by the rules below:

- If the total number of missing data points become equal to or greater than the "minimum specified missing number of the Time Series Data" specified in *missingData* condition over before the timer expires, a NOTIFY request shall be sent with the *missingDataList* and *currentMissingDataNr* included in the NOTIFY request. The missing data points counter is reset back to 0 and counting resumes while the timer continues to run (since it did not expire). Initiating NOTIFY request to report missing data points, as well as counter reset, shall follow the same logic described above until such time as the timer expires (see next bullet for behaviour when the timer expires).
- If the total number of missing data points do not exceed the "minimum specified missing number of the Time Series Data" specified in *missingData* condition over at timer expiry, a NOTIFY Request shall not be sent with the missing datapoints and the timer is restarted, and the missing data points counter is reset back to 0.
- The renewal of the timer and the missing data points counter upon timer expiry shall continue until such time as the subscription is cancelled or terminated. Once a subscription is terminated, a final NOTIFY request is sent out with the current number of missing data points and the timer is stopped.
- If no missing points have been detected at all during the life time of a subscription, then no timer shall be started at all. But once a timer is started triggered by the first missing data point, then the above rules in the previous bullets shall apply.

Figure 10.2.39-1 depicts the above rules.

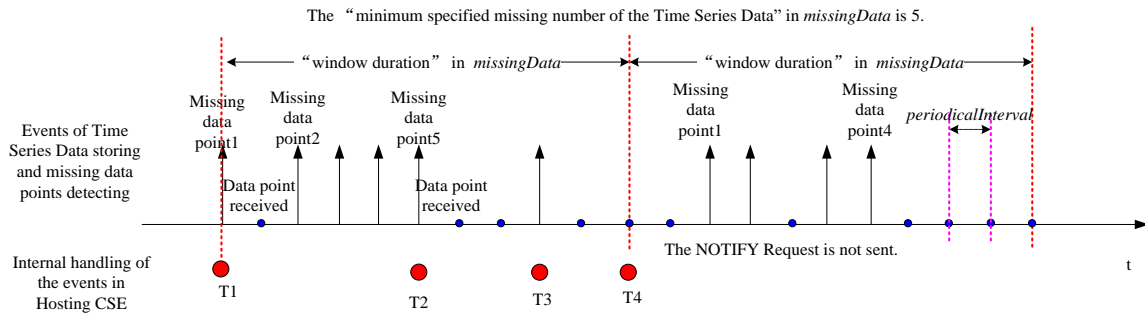

Figure 10.2.39-1: Time Series Data Detecting and Reporting Mechanism

- T1: the timer is started and the number of the missing data points is counted.
- T2: the NOTIFY Request is sent because the total number of missing data points becomes equal to or greater than the "minimum specified missing number of the Time Series Data" in *missingData* condition.
- T3: the NOTIFY Request is sent.
- T4: the timer is restarted and the missing data points counter is reset back to 0.

10.2.40 <schedule> Resource Procedures

10.2.40.1 Create <schedule>

This procedure shall be used for creating an <schedule> resource.

Table 10.2.40.1-1: <schedule> CREATE

<schedule> CREATE	
Associated Reference Point	Mca, Mcc and Mcc'
Information in Request message	All parameters defined in table 8.1.2-2 apply with the specific details for: Content: The resource content shall provide the information as defined in clause 9.6.9
Processing at Originator before sending Request	According to clause 10.1.1
Processing at Receiver	According to clause 10.1.1
Information in Response message	According to clause 10.1.1
Processing at Originator after receiving Response	According to clause 10.1.1
Exceptions	According to clause 10.1.1

10.2.40.2 Retrieve <schedule>

This procedure shall be used for retrieving the representation of the <schedule> resource.

Table 10.2.40.2-1: <schedule> RETRIEVE

<schedule> RETRIEVE	
Associated Reference Point	Mca, Mcc and Mcc'
Information in Request message	All parameters defined in table 8.1.2-2
Processing at Originator before sending Request	According to clause 10.1.2
Processing at Receiver	According to clause 10.1.2
Information in Response message	All parameters defined in table 8.1.3-1 apply with the specific details for: Content: attributes of the <schedule> resource as defined in clause 9.6.9
Processing at Originator after receiving Response	According to clause 10.1.2
Exceptions	According to clause 10.1.2

10.2.40.3 Update <schedule>

This procedure shall be used for updating the attributes and the actual data of an <schedule> resource.

Table 10.2.40.3-1: <schedule> UPDATE

<schedule> UPDATE	
Associated Reference Point	Mca, Mcc and Mcc'
Information in Request message	All parameters defined in table 8.1.2-2 apply with the specific details for: Content: attributes of the <schedule> resource as defined in clause 9.6.9 which need be updated
Processing at Originator before sending Request	According to clause 10.1.3
Processing at Receiver	According to clause 10.1.3
Information in Response message	According to clause 10.1.3
Processing at Originator after receiving Response	According to clause 10.1.3
Exceptions	According to clause 10.1.3

10.2.40.4 Delete <schedule>

This procedure shall be used for deleting the <schedule> resource with all related information.

Table 10.2.40.4-1: <schedule> DELETE

<schedule> DELETE	
Associated Reference Point	Mca, Mcc and Mcc'
Information in Request message	All parameters defined in table 8.1.2-2 apply
Processing at Originator before sending Request	According to clause 10.1.4.1
Processing at Receiver	According to clause 10.1.4.1
Information in Response message	According to clause 10.1.4.1
Processing at Originator after receiving Response	According to clause 10.1.4.1
Exceptions	According to clause 10.1.4.1

10.3 Notification procedures

10.3.1 Overview

In the present specification, notification procedures are defined in the following procedures:

- <subscription> resource handling (clause 10.2.12):
 - to notify Receiver(s) of modifications of a resource for an associated <subscription> resource;
 - to notify aggregated notifications from <subscription> member resources of <group> resource;
 - to request Receiver(s) to perform resource subscription verification;
 - to notify deletion of the <subscription> resource;
 - to seek authorization from the subscription creator during a notification target deletion.
- Asynchronous non-blocking request handling (clause 8.2.2.3):
 - to send the result of the request.
- <pollingChannelURI> resource handling (clause 10.2.13.8):
 - to send the response corresponding to a request delivered via service layer long polling.
- IPE on-demand discovery handling (clause 10.2.6):
 - to notify Receiver(s)(i.e., IPE) for on-demand discovery request.
- End-to-end security handling (clause 11.4):
 - to send the request/response that cannot be readable by Transit CSEs.
- Dynamic authorization consultation handling (clause 11.5):
 - to seek authorization to access a resource from Dynamic Authorization Server.

11 Trust Enabling Architecture

11.0 Overview

The Trust Enabling Architecture serves the purpose of establishing security and trust between all parties involved in the M2M ecosystem. It comprises the following infrastructure functions which may be external to the CSEs:

- M2M Enrolment functions(MEF), which manage the enrolment and configuration of M2M Nodes and M2M applications for access to M2M Services provided by an M2M Service Provider, prior to service operation (see clause 11.2). The credentials provisioned by a MEF can be used for Security Association Establishment Framework, End-to-End Security of Primitives or End-to-End Security of Data.
- M2M Authentication functions(MAF), which may facilitate identification and authentication of CSEs and AEs (see clause 11.3), End-to-End Security of Primitives (see clause 11.4.2) and End-to-End Security of Data (see clause 11.4.1) during M2M service operation. A single MAF may support all of the above security services or only a selection of them.
- Dynamic Authorization Systems and Role Authorities, which manage authorization privileges to access resources that may be assigned during operation (see clauses 11.3.4 and 11.5).
- Privacy Policy Managers that assist in the management of privacy preferences expressed by data subject with respect to service requirements and applicable regulations.

The above functionalities are assumed to be operated by trusted parties (generally M2M Service Providers but possibly other trusted third parties called M2M Trust Enablers (MTE)). These functions are all detailed in oneM2M TS-0003 [2].

A MAF interacts with a Security Principal via the reference point Mmaf. A MEF interacts with a Security Principal via the reference point Mmef. The Mmef reference point optionally supports triggering Device Configuration (defined in oneM2M TS-0022 [9]) and Certificate Provisioning (specified in oneM2M TS-0003 [2]). The communication protocols used on the reference points Mmaf and Mmef are specified in oneM2M TS-0032 [10].

11.1 Enrolling M2M Nodes and M2M Applications for oneM2M Services

Though M2M Nodes in the field domain are assumed to communicate without human involvement, individuals or organizations remain responsible for setting the access control policies used to authorize their M2M Nodes to access M2M services. In the following text, M2M Nodes refers to M2M field nodes.

In particular, individuals or organizations acquiring M2M Nodes can subscribe to a contract with an M2M Service provider (M2M Service Subscription) under which they enrol their M2M Nodes (e.g. using identifiers pre-provisioned on the nodes, such as Node-ID). This in turn may require an M2M Service provisioning step (including Security provisioning) that takes place on the target M2M Nodes themselves, for which interoperable procedures are specified by oneM2M (see clause 11.2.1). Following M2M service provisioning, the nodes can be identified and authenticated for association with an M2M Service Subscription, whose properties reflect the contractual agreement established between their owner and the M2M Service Provider.

Similarly, it may be possible for an M2M Service Provider to mandate that an M2M Application accessing M2M services be associated with a security credentials used to authorize specific operations to instance of that M2M Application, i.e. AEs (see clause 11.2.2). This step facilitates the deployment and management of M2M Applications that are instantiated in great numbers, as it enables all instances of an M2M Application to be managed through common security policies that are set once for all. It also enables keeping control over M2M Applications issued by untrusted sources.

The above steps may be delegated to an M2M trust enabler, when this role is not assumed by the M2M Service Provider.

11.2 M2M Initial Provisioning Procedures

11.2.1 M2M Node Enrolment and Service Provisioning

M2M service provisioning is the process by which M2M Nodes are loaded with the specific information needed to seamlessly access the M2M Services offered by an M2M Service Provider. This is an initial step performed only when an M2M Node is enrolled for using the M2M services of an M2M Service Provider. Though this process can be performed during device manufacturing, there is a need to enable this process to take place during field deployment in an interoperable way. M2M service provisioning assumes the existence of an M2M service subscription contracted with the target M2M Service Provider for the target M2M Node. Remote provisioning scenarios require the M2M Node to be mutually authenticated using pre-existing credentials (e.g. Node-ID and associated credential) with an M2M enrolment function, to securely exchange the provisioning information with the contracted M2M Service Provider. The M2M Service Provisioning takes place between an M2M Node (without provisioned CSE) and an M2M Service Provider via an M2M enrolment function. As a result of provisioning, M2M Nodes are provided with necessary credentials and possibly other M2M service related parameters (e.g. CSE-ID, M2M-Sub-ID).

The first step of M2M service provisioning is the security provisioning procedure, by which M2M service provider specific credentials are either shared between two M2M Nodes, or shared between the M2M Node in the field domain and an M2M authentication function in the infrastructure. Authenticated M2M Nodes can then be associated with an M2M Service Subscription used to determine their specific authorizations.

The following security provisioning scenarios are supported by the oneM2M architecture:

- Pre-provisioning:
 - Pre-provisioning includes all forms of out-of-band provisioning, e.g. provisioning M2M Nodes with M2M subscription information during the manufacturing stage.

- Remote provisioning:
 - Remote provisioning relies on pre-existing credentials in M2M Nodes (e.g. digital certificates or network access credentials) to provision subscription related parameters through a secure session with an M2M Enrolment Function. This form of provisioning enables M2M Nodes already in the field (e.g. operational M2M Nodes) to be provisioned with M2M Service subscription.
 - When supported, remote provisioning procedure shall be implemented as described in the oneM2M TS-0003 [2].
 - Following M2M service provisioning, the provisioned entity securely stores credentials used for authentication , with an associated lifetime (e.g. corresponding to the duration of the contractual agreement embodied by the M2M service subscription).

11.2.2 M2M Application Enrolment

This procedure is an optional step that enables the M2M SP and/or M2M Application provider to control which M2M Applications are allowed to use the M2M services. It assumes that the M2M Application is associated of a credential used for controlling authorization to M2M services The security credential associated with the App-ID or AE-ID may be used to grant specific authorization to M2M Application instances to access an approved list of M2M services, or revoke access to all instances of undesirable M2M Applications. Such authorization shall take place between registrar CSE and AE as specified in the present document and the oneM2M TS-0003 [2].

11.3 M2M Operational Security Procedures

11.3.0 Overview

This clause introduces the high level procedures, following M2M Enrolment, that shall be performed before any other procedure on Mcc and Mca can take place. These procedures shall be implemented as specified in the oneM2M TS-0003 [2].

NOTE: The detailed specifications of the security procedures in oneM2M TS-0003 [2] uses different labels for the steps shown in figures 11.3.1 and 11.3.2:

- Step1: Provisioning maps to *Credential Configuration*;
- Step 2: Identification maps to *Association Configuration*;
- Step 3: Authentication maps to *Association Handshake* in oneM2M TS-0003 [2].

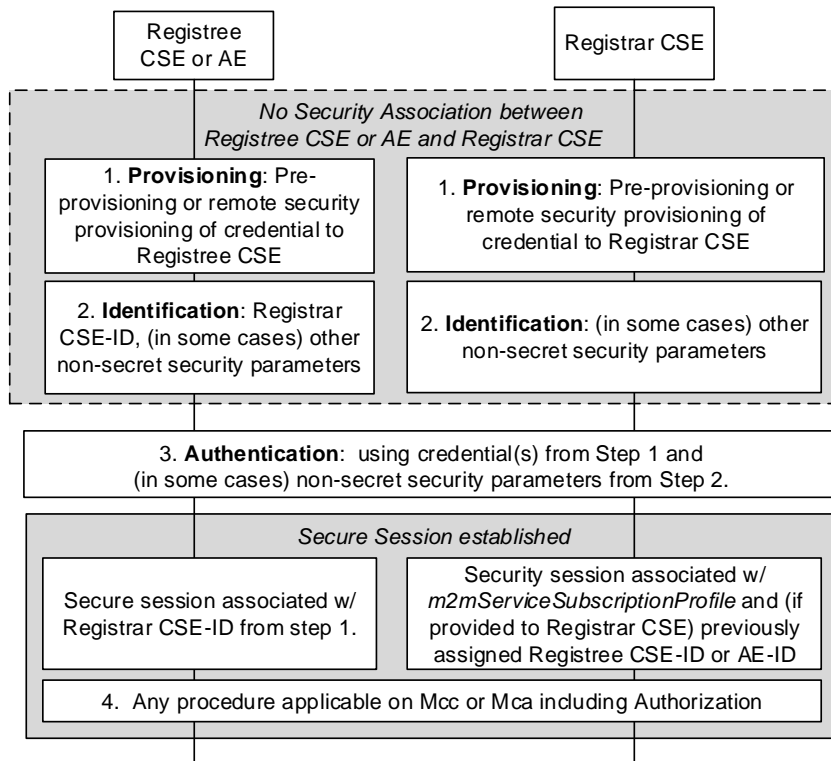

Figure 11.3.0-1: High Level Procedures on Mcc or Mca without MAF

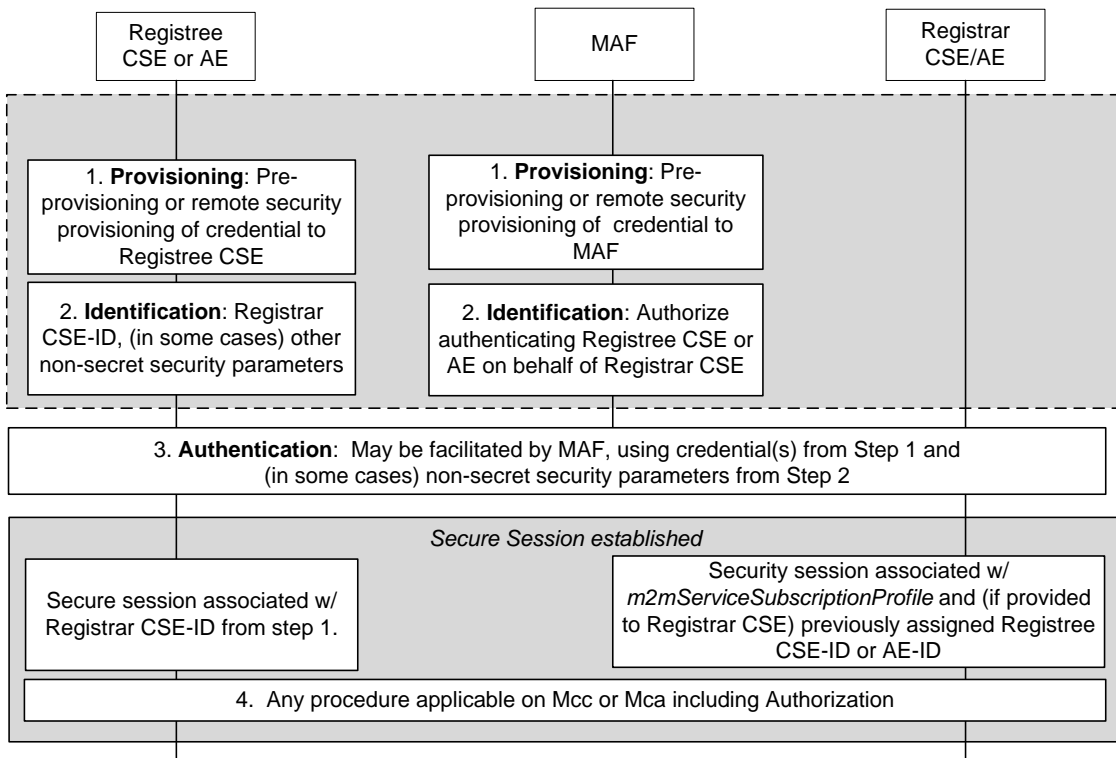

Figure 11.3.0-2: MAF assisted High Level Procedures on Mcc or Mca

11.3.1 Identification of CSE and AE

Once a CSE or AE is provisioned with its security credentials, there is no need to configure long-term secret information to the CSE or AE. However, additional non-secret information may need to be configured using the same security procedures.

Prior to a CSE or AE initiating security association establishment, the Registree CSE or AE is configured with the Registrar CSE-ID so that the Registree knows who to establish the security association with. This process is called "Association Configuration" in oneM2M TS-0003 [2].

11.3.2 Authentication and Security Association of CSE and AE

The association security handshake (see oneM2M TS-0003 [2]) provides:

- a) mutual authentication of CSE and AE; and
- b) session key derivation.

Prior to granting access to M2M services, the credentials resulting from the M2M Node and M2M application enrolment procedures shall be used, together with the information supplied in the identification step (clause 11.1), to perform mutual authentication of the Registree CSE or AE with the Registrar CSE. Upon mutual authentication:

- Registree CSE or AE associates, with the Registrar CSE, the CSE-ID supplied in the identification step (clause 11.1).
- If the Registree CSE or AE has previously registered successfully with the Registrar CSE and the Registrar CSE has retained the applicable M2M service subscription and CSE-ID or AE-ID, then the Registrar CSE can use this information.
- In other cases, the Registrar CSE determines the applicable M2M service subscription and CSE-ID or AE-ID as described in clause 10.1.1.2.

The Registree receives authorization to access the M2M services defined in the *<m2mServiceSubscription>* resources by checking privileges defined in *<accessControlPolicy>*, *<token>* or *<role>* resources.

NOTE: The authorization procedure to access the M2M services is further described in clause 11.3.4 and specified in detail in clause 7 of oneM2M TS-0003 [2].

Session keys are then derived for providing desired security services to the communicating entities, such as confidentiality and/or integrity of information exchange (these security services may be provided through establishment of a secure channel between the communicating entities or through object based security where only relevant information is encrypted prior to being shared). The lifetime of a security association shall be shorter than the lifetime of the credential used for authentication from which it is derived: It may be valid for the duration of a communication session, or be determined according to the validity period of the protected data. In case of a security association between two AEs, the lifetime of the security association can result from a contractual agreement between the subscribers of the communicating AEs.

11.3.3 Void

11.3.4 M2M Authorization Procedure

The M2M authorization procedure controls access to resources and services by CSEs and AEs. This procedure requires that the Originator has been identified to an M2M Authentication Function and mutually authenticated and associated with an M2M Service Subscription. Authorization depends on:

- The privileges set by the M2M Service Subscription associated with the Originator (e.g. service/role assigned to the Originator).
- These privileges are set-up based on the access control policies associated with the accessed resource or service. They condition the allowed operations (e.g. CREATE) based on the Originator's privileges and other access control attributes (e.g. contextual attributes such as time or geographic location).
- Role-IDs which have been associated with the Originator.

The authorization/access grant involves an Access Decision step to determine what the authenticated CSE or AE can actually access, by evaluating applicable access control policies based on the CSE or AE privileges. Access Decision is described in oneM2M TS-0003 [2].

The following set of access control policy attributes shall be available for an Access Decision.

- Access control attributes of Originator and Originator's Role (e.g. Role-IDs, CSE_IDs, AE-IDs, etc.).
- Access control attributes of Environment/Context (e.g. time, day, IP address, etc.).
- Access control attributes of Operations (e.g. Create, Execute, etc.).

The M2M Service Provider/administrator and owner of resources are responsible to establish access control policies that determine by whom, in what context and what operations may be performed upon those resources. If the request satisfies the owner's access control policy, then the access to the resource is granted.

Dynamic Authorization: Dynamic Authorization encompasses:

- a) authorizing the creation of a limited-lifetime access control policy authorizing the Originator to perform specific operations on the requested resource; and
- b) issuing limited-lifetime Tokens associating the Originator with Role-IDs and/or access control policies for identified resources.

Two forms of Dynamic Authorization are supported: Direct Dynamic Authorization and Indirect Dynamic Authorization.

In the event that the request does not satisfy any of the owner's access control policies, then Dynamic Authorization may be requested from Dynamic Authorization System (DAS) Servers; this is called *Direct Dynamic Authorization*, and relevant details are provided clause 11.5.2. The request is then re-evaluated to determine if the owner's access control policy is now satisfied and access is granted.

If access is still denied, then the Originator is provided with **Token Request Information** used to request the issuance of Tokens by a Dynamic Authorization System. A Token identifies Role-IDs and/or access control policies (for identified resources) which have been temporarily associated with the Originator. The Originator then resends the request from the Originator, this time adding any Token or Token-IDs received from the Dynamic Authorization System. This is called *Indirect Dynamic Authorization*, and relevant details are provided clause 11.5.3.

NOTE: A DAS Server can be triggered, by Dynamic Authorization, to update the access control policy configuration using oneM2M request primitives.

In the event that the requesting entity does not satisfy the owner's access control policy, a Hosting CSE shall check to see if the resource (or one of its parents) has a *dynamicAuthorizationConsultationIDs* which links to a valid *<dynamicAuthorizationConsultation>* resource. If there is no valid *<dynamicAuthorizationConsultation>* resource or if the *dynamicAuthorizationEnabled* attribute is set to "false", then the Hosting CSE shall not attempt to perform direct dynamic authorization on behalf of the requesting entity. However, if there is a valid *<dynamicAuthorizationConsultation>* resource available and if the *dynamicAuthorizationEnabled* attribute is set to "true", then the Hosting CSE shall initiate a direct dynamic authorization request to the specified *dynamicAuthorizationPoA*. If direct dynamic authorization results in sufficient privileges being granted to the requesting entity, the Hosting CSE shall grant it access. In addition the Hosting CSE may also dynamically create a new access control policy and configure it with the granted privileges along with any specified lifetime associated with the privileges based on a resource creation process initiated by the dynamic authorization system.

This function shall fetch the subscription related information in order to check if a Role-ID used in a request is allowed by the M2M service subscription. The authorization procedure shall be implemented as specified in the oneM2M TS-0003 [2].

11.4 Functional Architecture Specifications for End-to-End Security Procedures

11.4.1 Functional Architecture Specifications for End-to-End Security of Data (ESData)

End-to-End Security for Data (ESData) provides an interoperable framework for protecting data that ends up transported using oneM2M reference points, in order that so transited CSEs do not need to be trusted with that data. The data shall comprise either:

- All or part of the value of a single attribute (e.g. *content* attribute value of a *<contentInstance>* resource or *customAttribute* of a *<flexContainer>* resource) or a single addressable element within the attribute.
- All or part of a single primitive parameter value (e.g. a signed, self-contained access token communicated in a request primitive to obtain dynamic authorization).

11.4.2 Functional Architecture Specifications for End-to-End Security of Primitives (ESPrim)

End-to-End Security for Primitives (ESPrim) provides an interoperable framework for securing oneM2M primitives so CSEs do not need to be trusted with the confidentiality and integrity of the primitive. ESPrim provides mutual authentication, confidentiality, integrity protection and a freshness guarantee (bounding the age of secured primitives).

The credential management aspects and data protection aspects for ESPrim are specified in oneM2M TS-0003 [2]. The present clause specifies the transport of secured primitives.

The primitive to be secured is called the *inner primitive*, and the primitive which is used to transport a secured inner primitive is called the *outer primitive*. The inner primitive is protected using an encryption and integrity protection, which takes a symmetric key *sessionESPrimKey* as input. The *sessionESPrimKey* is derived from a *pairwiseESPrimKey*, established between the Originator and Receiver, and a *receiverESPrimRandObject* and *originatorESPrimRandObject*. The *receiverESPrimRandObject* and *originatorESPrimRandObject* are specified in oneM2M TS-0003 [2].

The transport details for the ESPrim Procedure are shown in figures 11.4.2-1 and 11.4.2-2, and described in the following text.

- NOTE 1: The outer primitive is not acting on resources because the outer primitive is only used to transport the ESPrim object securing the inner primitive. This is the reason that the NOTIFY procedure is used for the outer primitive.

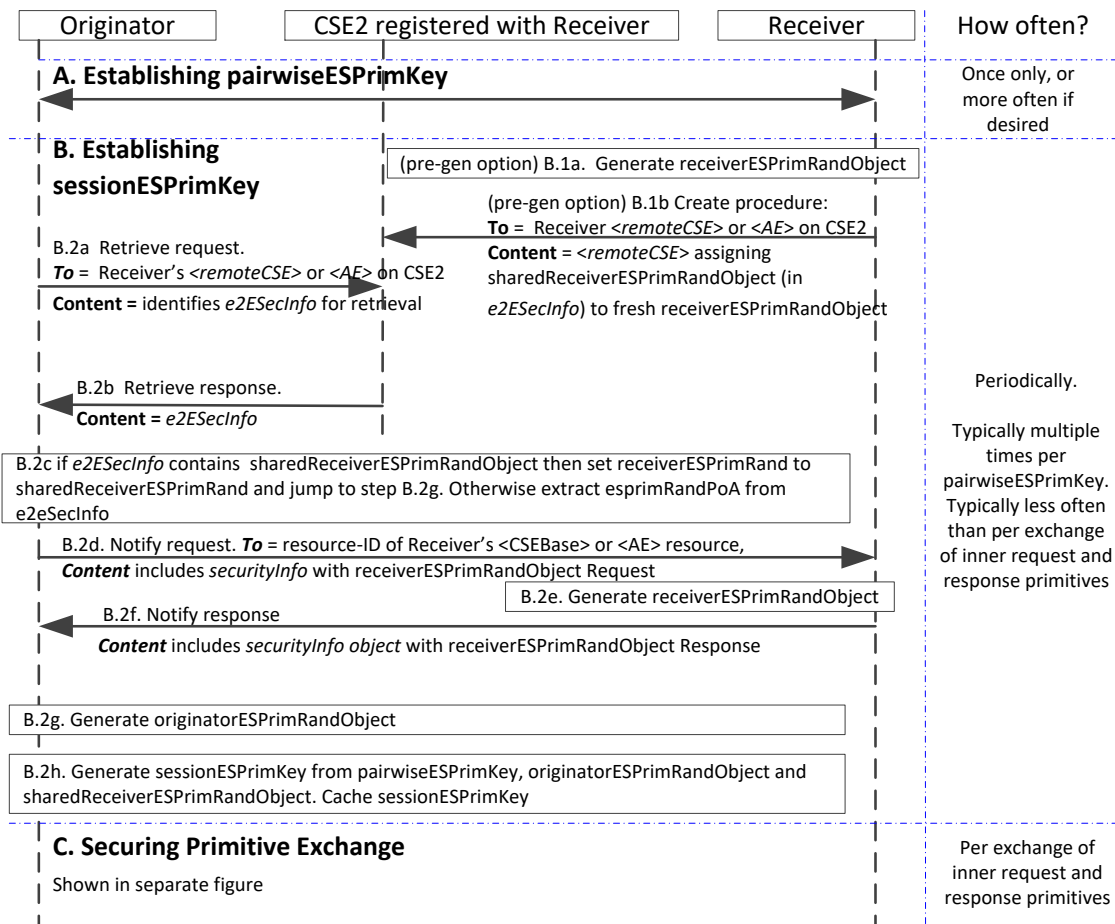

Figure 11.4.2-1: The transport details for establishing pairwiseESPrimKey and establishing sessionESPrimKey in the End-to-End Security of Primitives (ESPrim) Procedure. This message flow shows the sequence of events for Blocking Mode

- A. **Establishing pairwiseESPrimKey:** The pairwiseESPrimKey shall be established as specified in clause 8.4.2 "End-to-End Security of Primitives (ESPrim) Architecture" in oneM2M TS-0003 [2].
- B. **Establishing sessionESPrimKey:** The Receiver shall select to either (a) pre-generate a receiverESPrimRandObject which is distributed for used by multiple Originators for establishing sessionESPrimKey, or (b) generate a unique receiverESPrimRand Object upon request (in which case no action is required prior to receiving such a request):
 - B.1. **(Optional) Receiver pre-generates and distributes receiverESPrimRandObject.** If the Receiver selected to pre-generate and distribute a receiverESPrimRandObject, the Receiver performs the following steps every time the Receiver wishes to provide a new shared receiverESPrimRandObject:
 - B.1a The Receiver shall generate a receiverESPrimRandObject as described in oneM2M TS-0003 [2].
 - B.1b The Receiver shall update the Receiver's <remoteCSE> or <AE> resource on all CSEs to which the Receiver is registered, with the sharedReceiverESPrimRand Object parameter of the e2eSecInfo attribute containing the generated receiverESPrimRandObject.

In the latter case, the Receiver shall ensure that the sharedReceiverESPrimRandObject parameter is not present in the e2eSecInfo attribute in the Receiver's <remoteCSE> or <AE> resource on all CSEs to which the Receiver is registered. The absence of the sharedReceiverESPrimRand Object parameter indicates that the Receiver will provide a unique receiverESPrimRand Object upon request.

B.2. Originator obtains *receiverESPrimRandObject*:

B.2a The Originator shall perform a Retrieve on the *e2eSecInfo* attribute in the Receiver's *<remoteCSE>* or *<AE>* resource on a CSE, here denoted CSE2, with which the Receiver is registered.

B.2b If the *e2eSecInfo* attribute is present in the Receiver's *<remoteCSE>* or *<AE>* resource on CSE2, then CSE2 shall return the *e2eSecInfo* attribute. Otherwise CSE2 shall return an appropriate error message.

B.2c (This step is also described in oneM2M TS-0003 [2]. Where there is a conflict, oneM2M TS-0003 [2] is to be treated as the authoritative description). The Originator determines if the Receiver supports ESPrim, which requires that the *e2eSecInfo* attribute is present and the *e2eSecInfo* attribute indicates support for ESPrim:

B.2c.1 If the Receiver does not support ESPrim, then the Originator aborts the procedure.

B.2c.2 If the Receiver supports ESPrim, and the *e2eSecInfo* attribute includes a *sharedReceiverESPrimRandObject* parameter, then the Originator shall examine the *ESPrimRandExpiry* in this parameter to determine if the *sharedReceiverESPrimRandObject* has expired. If the *sharedReceiverESPrimRandObject* has not expired, then the Originator sets *receiverESPrimRandObject* to the value of *sharedReceiverESPrimRandObject* and proceeds to step B.2g. If the *sharedReceiverESPrimRandObject* has expired, then the Originator sets *receiverESPrimRandObject* to the value of *receiverESPrimRandObject* and proceeds to step B.2d.

B.2c.3 If the Receiver supports ESPrim, and the *e2eSecInfo* attribute does not include a *sharedReceiverESPrimRandObject* parameter, then the Originator proceeds to step B.2d.

B.2d The Originator shall send a NOTIFY request to the Receiver with the To parameter set to the address of the Receiver's *<CSEBase>* or *<AE>* resource, and the *securityInfo Type* element of the *securityInfo* object in the **Content** indicating that this NOTIFY request is a "receiverESPrimRandObject request".

NOTE 2: When the Receiver is a CSE, the Originator can use the Receiver's CSE-ID followed by "/" as the address of the Receiver's *<CSEBase>*.

B.2e The Receiver, upon receiving such a NOTIFY request, shall generate a *receiverESPrimRandObject* as described in oneM2M TS-0003 [2].

B.2f The Receiver shall send a NOTIFY response to the Originator with the *securityInfoType* element of the *securityInfo* object in the **Content** indicating that this is a "receiverESPrimRandObject request" and containing the *receiverESPrimRandObject*.

B.2g The Originator shall generate an *originatorESPrimRandObject* as described in clause 8.4.2 of oneM2M TS-0003 [2].

B.2h The Originator shall generate the *sessionESPrimKey* from the *pairwiseESPrimKey*, *originatorESPrimRandTuple* and *receiverESPrimRandObject* as described in clause 8.4.2 of oneM2M TS-0003 [2].

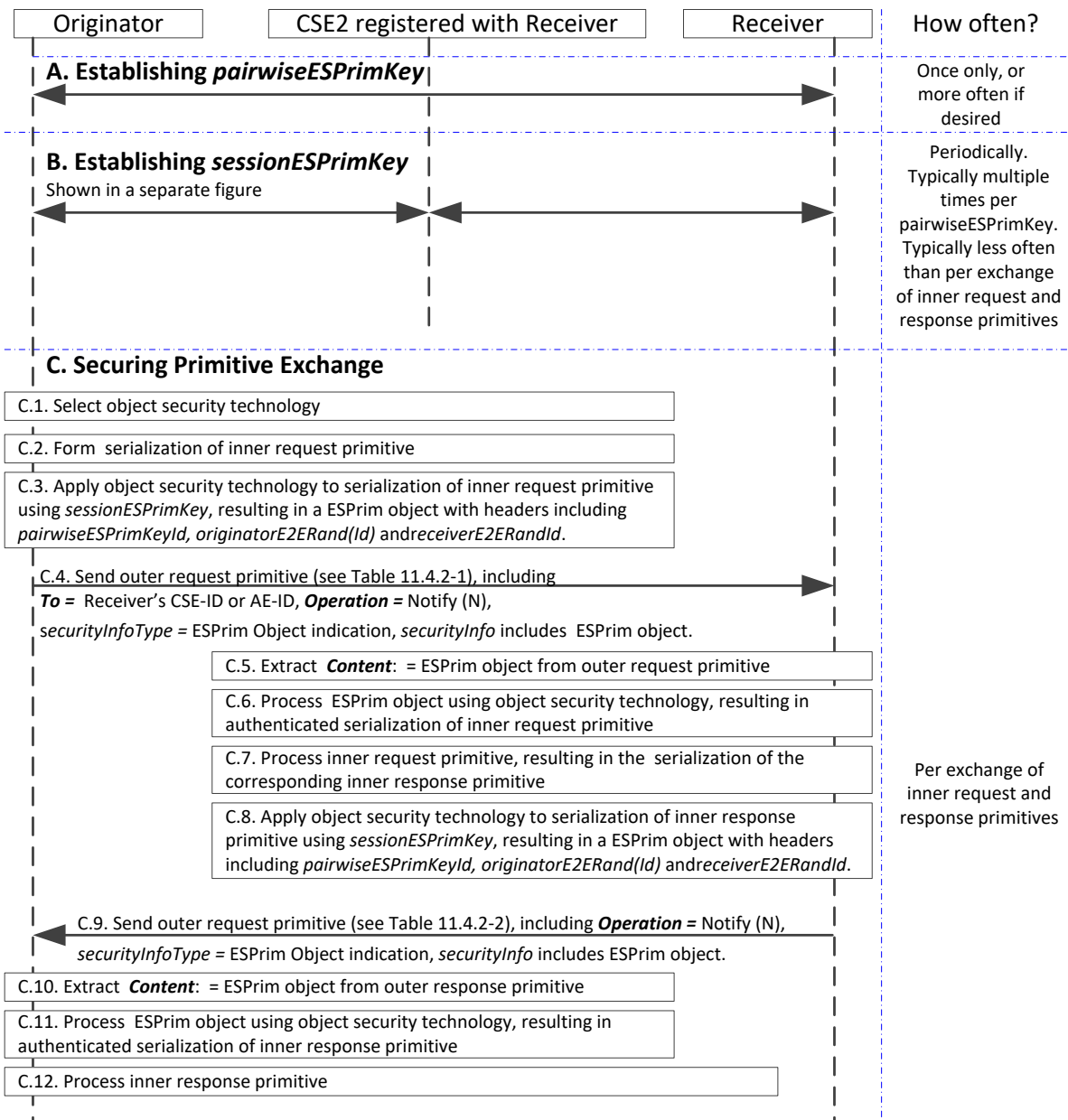

Figure 11.4.2-2: The transport details for Securing a Primitive Exchange in the End-to-End Security of Primitives (ESPrim) Procedure
This message flow shows the sequence of events for Blocking Mode

C. Securing a Primitive Exchange

- C.1 The Originator selects the object security technology as described in clause 8.4.2 of oneM2M TS-0003 [2].
- C.2 The Originator shall form the serialization of the inner request primitive.
- C.3 The Originator shall produce a ESPrim Object from the serialization of the inner request primitive by applying the selected object security technology using the established parameters, as described in clause 8.4.2 of oneM2M TS-0003 [2].
- C.4 The Originator shall send the ESPrim Object to the Receiver in the *securityInfo* object in the *Content* of an outer request primitive, and including the indication that *securityInfo* contains an ESPrim Object. The outer request primitive shall be a NOTIFY request primitive with *To* set to the address of the Receiver's <CSEBase> or <AE> resource. See note 2. The parameters of the outer request primitive shall be assigned as described in table 11.4.2-1.

C.5 The Receiver shall process the outer request primitive as for normal NOTIFY request primitives. The Receiver shall extract *securityInfo*, process the indication that it contains an ESPrim Object, and extract the ESPrim Object containing the secured inner request primitive.

C.6 The Receiver shall process the ESPrim Object according to the indicated object security technology resulting in the verified serialization of the inner request primitive. This processing is described in clause 8.4.2 of oneM2M TS-0003 [2].

C.6a If this processing is unsuccessful, then the Receiver shall generate an error message:

C.6a.1 If the Receiver knows a currently valid *sessionESPrimKey* previously established with the Originator, then the receiver shall secure the error message using ESPrim as described in clause 8.4.2 of TS-0003 [2]. In this case the message flow skips to step C.9.

C.6a.2 If Receiver does not know a currently valid *sessionESPrimKey* previously established with the Originator, then the Receiver shall send a NOTIFY response with the (unsecured) error message in the *Content* parameter. The Originator processes the response as for a normal error case.

C.7 The Receiver shall process the inner request primitive, resulting in a serialization of the corresponding inner response primitive.

NOTE 3: Steps C.3 to C.7 are mirrored closely by C.10 to C.16, with the Originator and Receiver swapping their participation in the exchange, and the request primitives replaced by response primitives.

C.8 The Receiver shall produce a ESPrim Object from the serialization of the inner response primitive by applying the selected object security technology using the established parameters, as described in clause 8.4.2 of oneM2M TS-0003 [2].

C.9 The Receiver shall send the ESPrim Object to the Originator in the *securityInfo* object of an outer response primitive, including the indication that *securityInfo* contains an ESPrim Object. The outer response primitive shall be a NOTIFY response primitive. The parameters of the outer request primitive shall be assigned as described in table 11.4.2-2.

C.10 The Originator shall process the outer response primitive as for normal NOTIFY response primitives. The Originator shall extract the *securityInfo* object, process the indication in *securityInfoType* that *securityInfo* contains an ESPrim Object, and extract the ESPrim Object containing the secured inner response primitive.

C.11 The Originator shall process the ESPrim Object according to the indicated object security technology resulting in the verified serialization of the inner response primitive or an error message. This processing is described in clause 8.4.2 of oneM2M TS-0003 [2].

C.12 The Originator shall process the inner response primitive or error message.

Table 11.4.2-1: NOTIFY Request Message Parameters when using ESPrim

Request message parameter		Mandatory/ Optional for ESPrim	Details
Mandatory	Operation - operation to be executed	M	NOTIFY
	To - the address of the target resource on the target CSE	M	Address of the Receiver's <CSEBase> or <AE> resource
	From - the identifier of the message Originator	M	
	Request Identifier - uniquely identifies a Request message	M	May be independent of the Request Identifier of the inner request primitive
Operation dependent	Content - to be transferred	NP	
	Resource Type - of resource to be created	N/A	N/A
Optional	Originating Timestamp - when the message was built	O	Time when the outer request primitive was build
	Request Expiration Timestamp - when the request message expires	O	Copied from the corresponding parameter in the inner request primitive
	Result Expiration Timestamp - when the result message expires	O	Copied from the corresponding parameter in the inner request primitive
	Operational Execution Time - the time when the specified operation is to be executed by the target CSE	N/A	The operation execution here is the cryptographic operations performed by the Receiver, which shall be executed immediately
	Response Type - type of response that shall be sent to the Originator	O	Any mode may be applied
	Result Persistence - the duration for which the reference containing the responses is to persist	N/A	N/A for NOTIFY
	Result Content - the expected components of the result	N/A	The result content here is the Result Content of the outer primitive, which is always ESPrim Object
	Event Category - indicates how and when the system should deliver the message	O	Copied from the corresponding parameter in the inner request primitive
	Delivery Aggregation - aggregation of requests to the same target CSE is to be used	O	Copied from the corresponding parameter in the inner request primitive
	Group Request Identifier - Identifier added to the group request that is to be fanned out to each member of the group	N/A	This parameter may be present in the inner request primitive, but shall not be present in the outer primitive
	Filter Criteria - conditions for filtered retrieve operation	N/A	N/A for NOTIFY
Discovery Result Type - format of information returned for Discovery operation	N/A	N/A for NOTIFY	

Table 11.4.2-2: NOTIFY Response Message Parameters when using ESPrim

Response message parameter/success or not	Mandatory/Optional for ESPrim	Details
Request Identifier - uniquely identifies a Request message	M	Matches corresponding parameter in outer request primitive
Content - to be transferred	NP	ESPrim Object
To - the identifier of the Originator or the Transit CSE that sent the corresponding non-blocking request	O	As for NOTIFY
From - the identifier of the Receiver	O	As for NOTIFY
Originating Timestamp - when the message was built	O	Time when the outer request primitive was build
Result Expiration Timestamp - when the message expires	O	Copied from the corresponding parameter in the inner request primitive
Event Category - what event category shall be used for the response message	O	Copied from the corresponding parameter in the inner request primitive
Content Status	N/A	N/A for NOTIFY
Content Offset	N/A	N/A for NOTIFY

11.4.3 Functional Architecture Specifications for Direct End-to-End Security Certificate-based Key Establishment (ESCertKE)

The ESCertKE procedure comprises the exchange of TLS handshake protocol parameters in four ESCertKE Messages, specified in oneM2M TS-0003 [2]. The AE or CSE initiating the procedure is the *Initiating End-Point* and the *Terminating End-Point* is the AE or CSE with which the ESCertKE Initiating End-Point intends to establish the pairwiseE2EKey.

If an AE or CSE supports ESCertKE, then an indication shall be present in the *e2eSecInfo* attribute in an AE's <AE> resource, or a CSE's <CSEBase> resource or a CSE's <remoteCSE> resource.

The ESCertKE messages and associated processing for ESCertKE are specified in clause 8.7 "End-to-End Certificate-based Key Establishment (ESCertKE)" in oneM2M TS-0003 [2]. The transport details for the ESCertKE Procedure are shown in figure 11.4.3-1, and described in the following text.

NOTE: The outer primitive is not acting on resources because the outer primitive is only used to transport the ESCertKE messages. This is the reason that the NOTIFY procedure is used for the outer primitive.

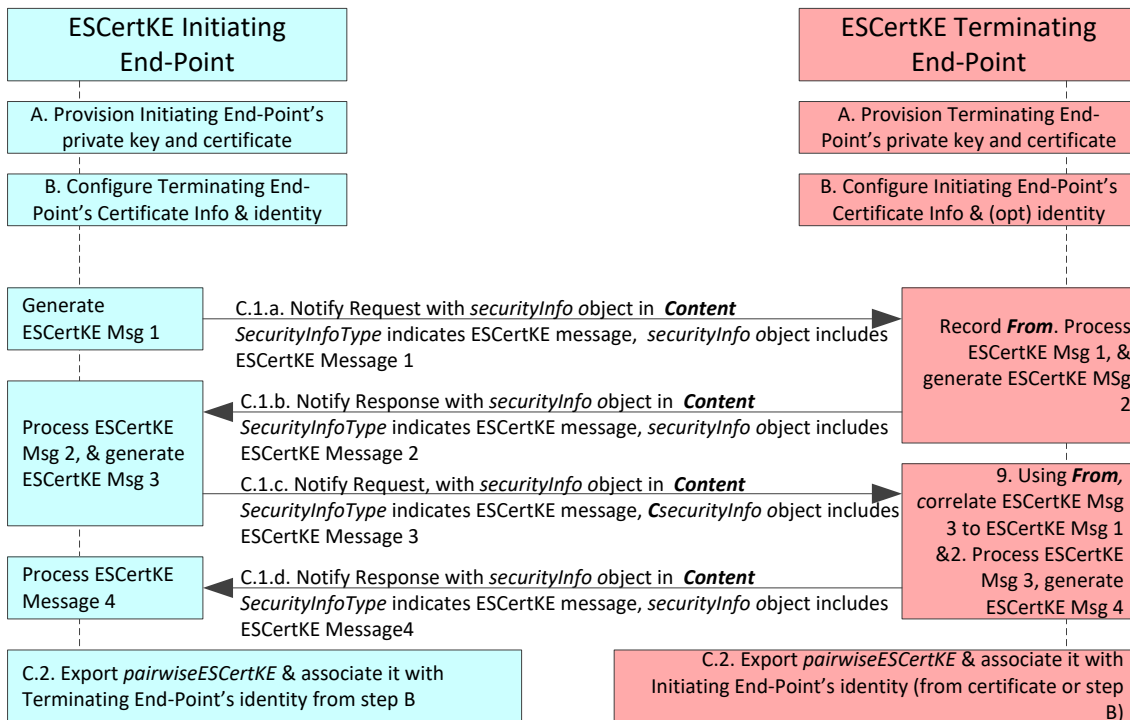

Figure 11.4.3-1: The transport details for the ESCertKE Procedure

- A. **Provisioning Certificates:** Each End-Points shall be provisioned with their own private keys and corresponding certificate and optional certificate chain.
- B. **Triggering:** The Initiating End-Points is decides to initiate the ESCertKE procedure with an identified Terminating End-Point.
- C. **Establishing pairwiseE2EKey:**
- C.1 The Initiating End-Point and Terminating End-Point exchange the sequence of four ESCertKE Messages specified in clause 8.7 "End-to-End Certificate-based Key Establishment" in oneM2M TS-0003 [2]. The ESCertKE Messages are exchange in two sequential NOTIFY procedures:
- C.1a ESCertKE Message 1 is sent in a first NOTIFY request from the Initiating End-Point to the End-Point. The Terminating End-Point records the identity of the Initiating End-Point in the **From** primitive parameter.
- C.1b ESCertKE Message 2 is sent in the resulting NOTIFY response from the Terminating End-Point to the Initiating End-Point.
- C.1c ESCertKE Message 3 is sent in a second NOTIFY request from the Initiating End-Point to the End-Point. The Terminating End-Point shall correlate this ESCertKE message with the corresponding ESCertKE Message 1 using the identity of the Initiating End-Point in the **From** primitive parameter.
- C.1.d ESCertKE Message 4 is sent in the resulting NOTIFY response from the Terminating End-Point to the Initiating End-Point.
- The parameters of the NOTIFY primitives shall be assigned as per normal, with the following details specific to ESCertKE:
- *securityInfo Type*: indicating that the **Content** contains an ESCertKE Message.
 - **Content**: an ESCertKE Message.
- C.2 If the TLS handshake protocol is successful, then the Initiating and Terminating End-Points shall generate and cache a pairwiseE2EKey as described 8.7 "End-to-End Certificate-based Key Establishment" in oneM2M TS-0003 [2].

11.5 Functional Architecture Specifications for Dynamic Authorization

11.5.1 Dynamic Authorization Reference Model

The Dynamic Authorization reference model is shown in figure 11.5.1-1.

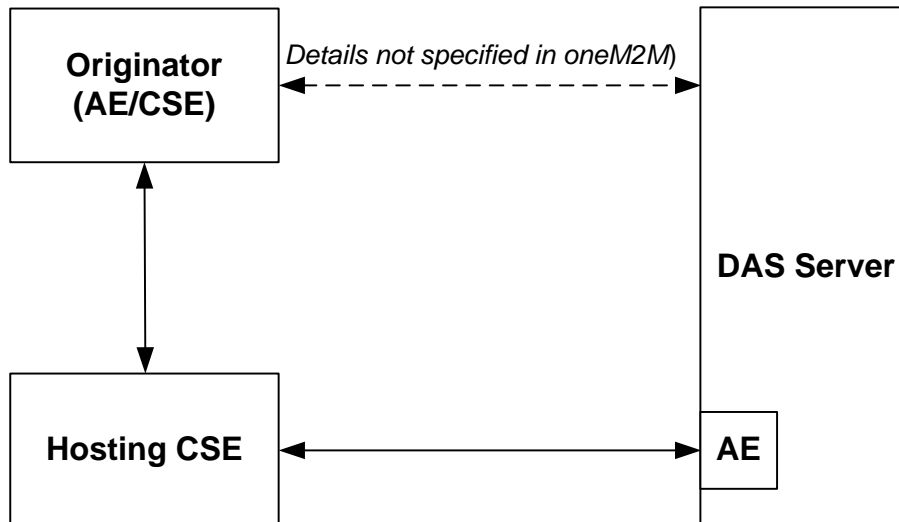

Figure 11.5.1-1: Dynamic Authorization reference model

The Dynamic Authorization reference model introduces the following systems and entities:

- Dynamic Authorization System (DAS): A system supporting dynamically authorization on behalf of resources owners. The present document does not describe the processing and exchange of messages within the Dynamic Authorization System. This system may reside either internally or externally within the service provider network.
- Dynamic Authorization System (DAS) Server: A server configured with policies for dynamic authorization, and provided with credentials for issuing Tokens. The DAS Server may include an AE for interaction with the oneM2M system.

The following Dynamic Authorization procedures are specified:

- **Direct Dynamic Authorization**, summarized in figure 11.5.1-2. In this procedure, Hosting CSE interacts with the DAS Server to obtain Dynamic Authorization.

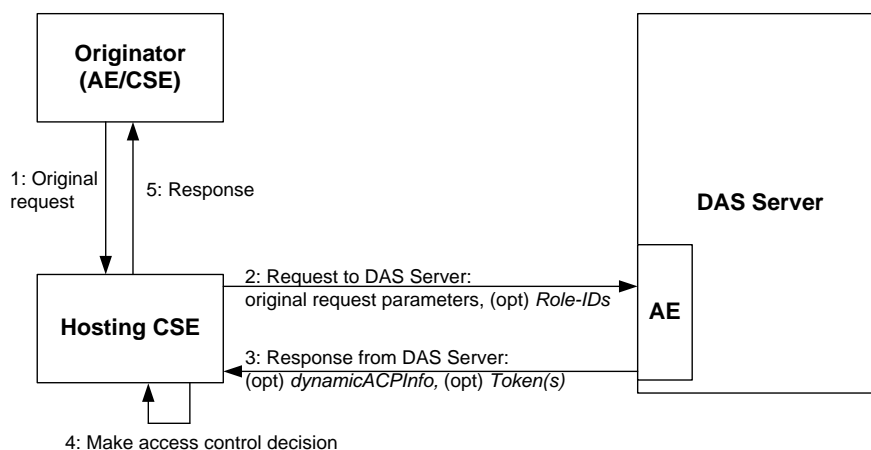

Figure 11.5.1-2: Direct Dynamic Authorization

- **Indirect Dynamic Authorization**, summarized in figure 11.5.1-3:
 - Steps 1-2: The Hosting CSE may provide the Originator with **Token Request Information** in the unsuccessful response.
 - Steps 3: The Originator interacts with the DAS Server with the intention that the DAS Server issue **Tokens** authorizing the Originator, and the Originator is provided with the Token or a Token-ID. The interaction is not described in the present specification.
 - Steps 4-7: The Originator provides the Hosting CSE with a **Token, Token-ID** to indicate that the Token is to be considered in the access decision. In the case of a token-ID, the Hosting CSE retrieves the corresponding Token via an AE of the DAS Server. These are then used in the access decision. The Hosting CSE may provide the Originator with a **Local-Token-ID** may be used to identify the Token.

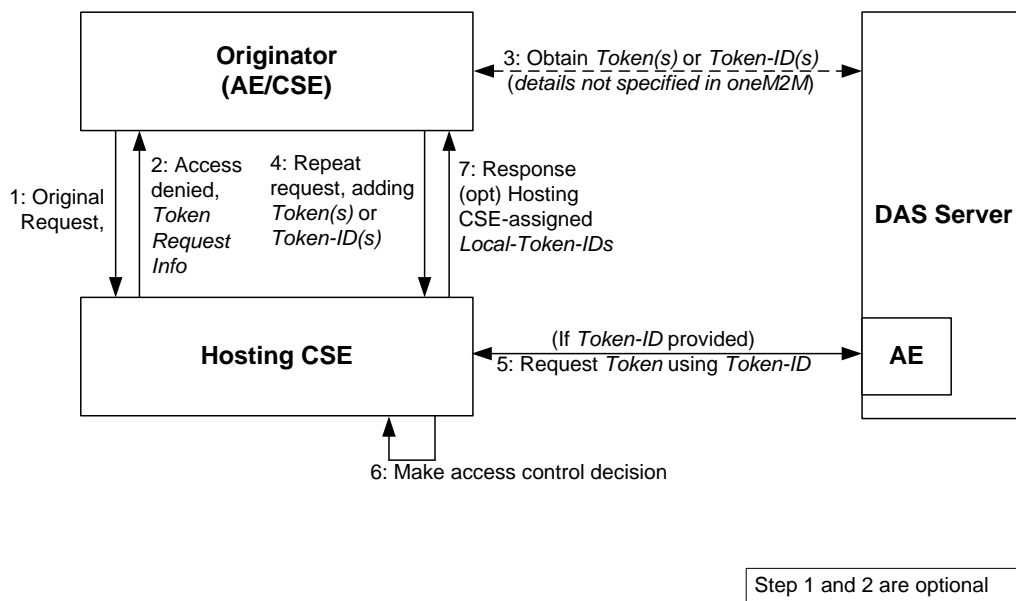

Figure 11.5.1-3: Indirect Dynamic Authorization

11.5.2 Direct Dynamic Authorization

The parameters exchanged for Direct Dynamic Authorization, and the corresponding processing, are specified in clause 7.3.2.2, oneM2M TS-0003 [2]. The present clause specifies the transportation of parameters when oneM2M primitives are used. The step numbers are aligned with the procedure in clause 7.3.2.2, oneM2M TS-0003 [2]. Further details for each step in the present clause can be obtained by examining the corresponding steps in clause 7.3.2.2, oneM2M TS-0003 [2].

The message flow for Direct Dynamic Authorization is shown in figure 11.5.2-1, and described in the following text. This call flow assumes that the Hosting CSE has already received the resource access request from the Originator.

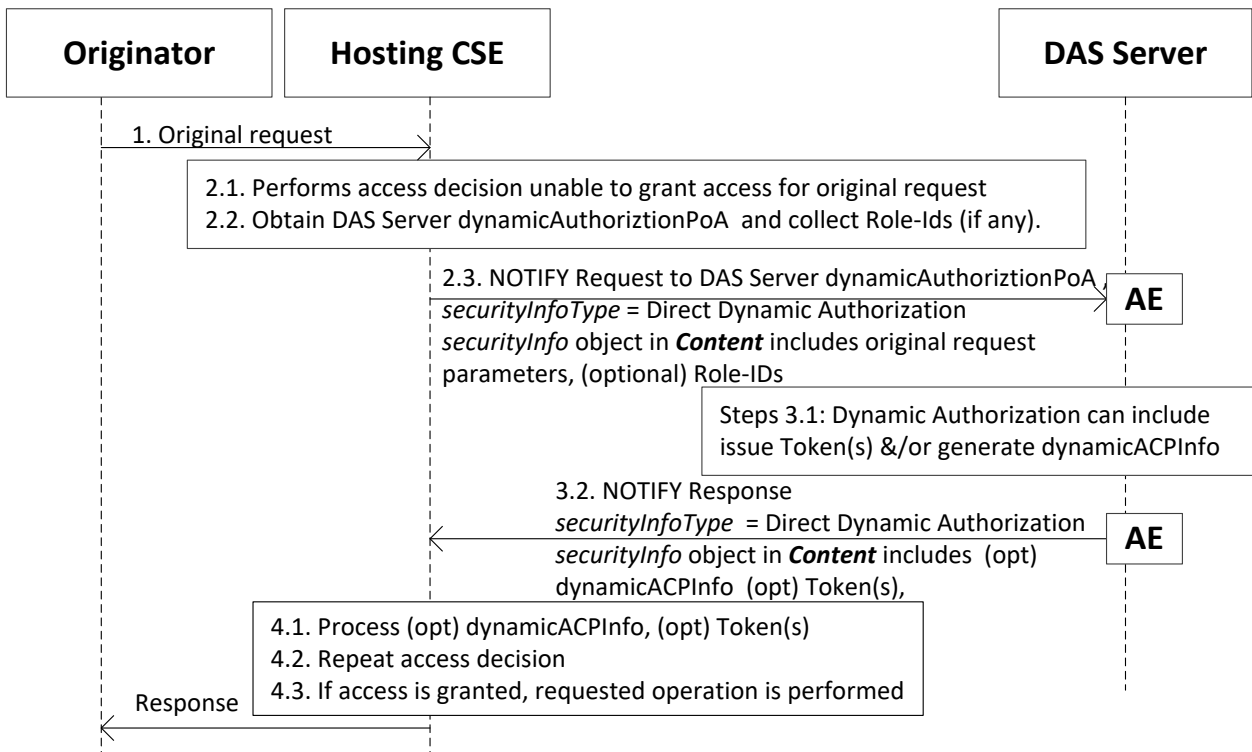

Figure 11.5.2-1: Message flow showing transport details for Direct Dynamic Authorization

- The Originator sends request (called the request from the Originator for this message flow) to the Hosting CSE. This request may include *Tokens*, *Token IDs* or *LocalToken IDs*; see the clause 11.5.3 "Indirect Dynamic Authorization".
- Initial Hosting CSE processing:
 - 2.1 If the request from the Originator includes *Token*, *Token IDs* or *LocalToken IDs* then these are processed as described in clause 11.5.3 "Indirect Dynamic Authorization". The Hosting CSE evaluates the access decision algorithm, but is unable to grant access for the request from the Originator based on configured access control policies.
 - 2.2 The Hosting CSE examines the *<accessControlPolicy>* resources and *<dynamicAuthorizationConsultation>* resources to obtain the DAS Server *dynamicAuthorizationPoA* with which it may perform Direct Dynamic Authorization. The Hosting CSE selects a DAS Server and forms the set of applicable Role-IDs (if any) to send to the corresponding DAS Server.
 - 2.3 The Hosting CSE shall send a Notify request primitive to the DAS Server AE, with the following details specific to Direct Dynamic Authorization:
 - The *securityInfo Type* element shall indicate that the Notify request primitive is for Direct Dynamic Authorization.
 - The *Content* parameter shall contain information that the DAS Server can use in deciding what Dynamic Authorizations should be applied. This information includes primitive parameters from the request from the Originator and the set of applicable Role-IDs (if any). Clauses 7.3.2.2, oneM2M TS-0003 [2] lists the primitive parameters to be included.
- DAS Server processing:
 - 3.1 The DAS Server shall extract and parse the *Content* parameter of the received message. The DAS Server may issue *Token(s)* and/or generate *dynamicACPIInfo* which will be used by the Hosting CSE to create a dynamic *<accesscontrolPolicy>* resource.

- 3.2 The DAS Server shall send a Notify response primitive via the DAS Server AE to the Hosting CSE, with the following details specific to Direct Dynamic Authorization:
 - The *securityInfo Type* element shall indicate that the Notify response primitive is for Direct Dynamic Authorization.
 - If step 3.1 resulted in a Token(s) and/or dynamicACPIInfo parameter, then these parameters shall be included in the *Content* parameter, otherwise the *Content* parameter shall not be present.
- Hosting CSE Processing:
 - 4.1 The Hosting CSE shall process the *Content* parameter (if present) of the NOTIFY Response from the DAS Server:
 - The Hosting CSE shall verify and cache the Token(s) in the list (if present).
 - The Hosting CSE shall create a dynamic *<accessControlPolicy>* resource from dynamicACPIInfo (if present).
 - 4.2 The Hosting CSE repeats the access decision mechanism.
 - 4.3 If access is granted, then the Hosting CSE performs the operation requested in the request from the Originator.

11.5.3 Indirect Dynamic Authorization

The parameters exchanged for Indirect Dynamic Authorization, and the corresponding processing, are specified in clause 7.3.2.3, oneM2M TS-0003 [2]. The present clause specifies the transportation of parameters when oneM2M primitives are used. Further details for each step in the present clause can be obtained by examining the corresponding steps in clause 7.3.2.3, oneM2M TS-0003 [2].

The message flow for the Indirect Dynamic Authorization Procedure is shown in figure 11.5.3-1, and described in the following text.

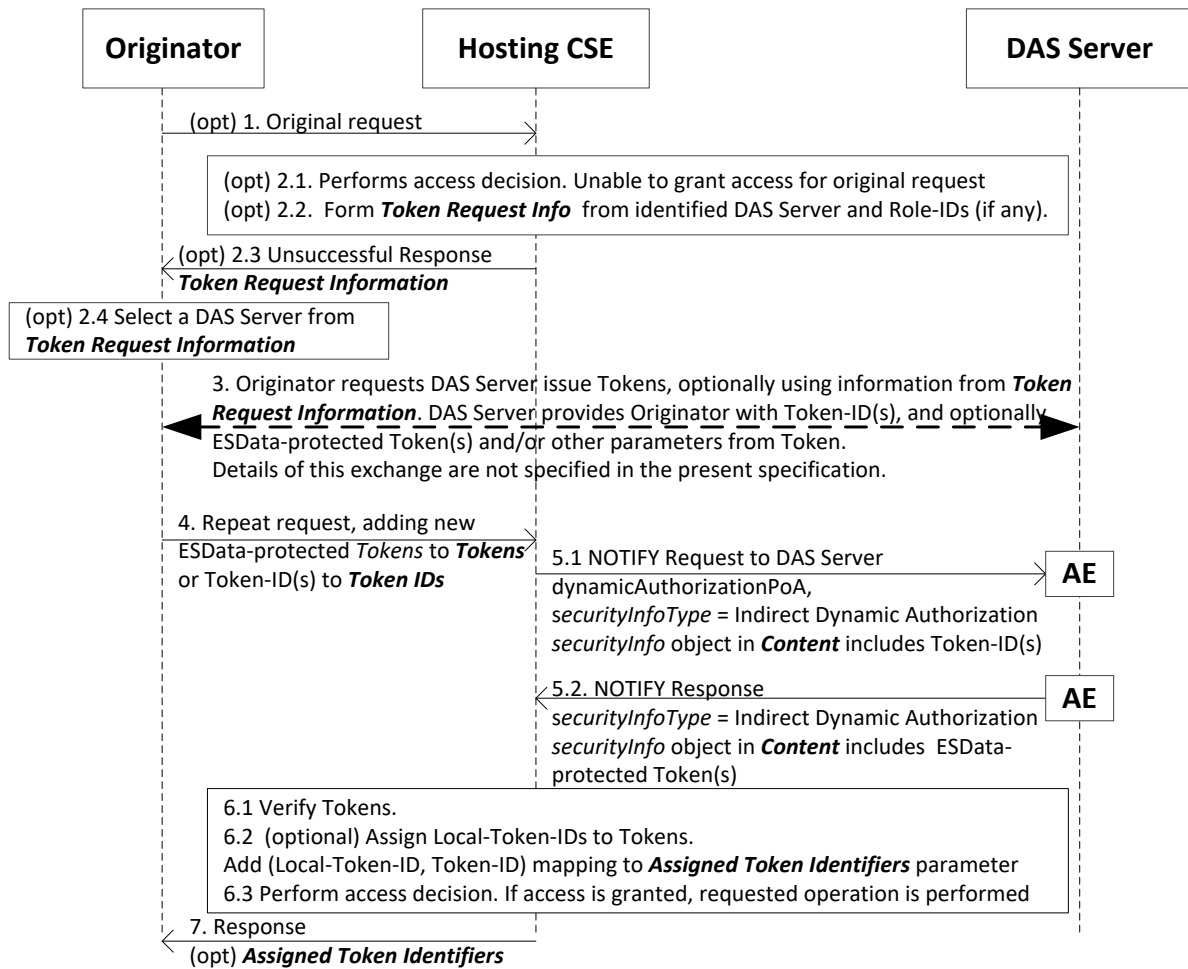

Figure 11.5.3-1: Message flow for Indirect Dynamic Authorization

- (Optional) The Originator sends request to the Hosting CSE. This request may include **Tokens**, **Token IDs** or **Local Token IDs**, but this message flow assumes that these do not provide sufficient permissions for accessing the requested resource.
- (Optional) Initial Hosting CSE processing:
 - 2.1 Hosting CSE performs the access decision for the request from the Originator. This call flow assumes that the request from the Originator is denied as a result of the access decision.
 - 2.2 The Hosting CSE forms the **Token Request Information** primitive parameter.
 - 2.3 The Hosting CSE shall send, to the Originator, an unsuccessful resource access response with the following details specific to the Indirect Dynamic Authorization procedure:
 - The **Response Status Code** shall be set to "UNAUTHORIZED".
 - The **Token Request Information** primitive parameter shall be included.
 - 2.4 The Originator selects a DAS Server identified in **Token Request Information** primitive parameter.

- The Originator shall interact with the DAS Server to request the issuance of one or more Tokens. The Originator can provide information for the DAS Server provided in the ***Token Request Information***, and parameters from the original resource access request. The DAS Server issues a Token(s) and provides the Token-ID(s) and optionally the ESData-protected Token(s) to the Originator. The DAS Server can also provide the Originator with other parameters from the Token; for example, the time window in which the Token is valid. This interaction is specific to the Dynamic Authorization System technology being used.
- The Originator shall repeat the original resource access request, with the following changes:
 - ***Tokens***: add the ESData-protected Token(s) provided by the DAS Server; and
 - ***Token IDs***: add Token-ID if the ESData-protected Token(s) was not provided by the DAS Server.
- (Optional) If the request includes Token-DI(s), then for each Token-ID the Hosting CSE identifies the corresponding DAS Server AE from which to request the corresponding Token, and the following steps shall be performed. The Hosting CSE may collect the Token-ID(s) corresponding to a single DAS Server and perform the following steps once rather than repeating the steps for each token:
 - 5.1 The Hosting CSE shall send a Notify request primitive to the DAS Server AE, with the following details specific to Indirect Dynamic Authorization:
 - The *securityInfo Type* object parameter shall indicate that the Notify request primitive is for Indirect Dynamic Authorization.
 - The ***Content*** parameter shall contain the Token-ID(s) associated with that DAS Server.
 - 5.2 The DAS Server shall send a Notify response primitive via the DAS Server AE to the Hosting CSE, with the following details specific to Direct Dynamic Authorization:
 - The *securityInfo Type* object parameter shall indicate that the Notify response primitive is for Indirect Dynamic Authorization.
 - The ***Content*** parameter shall contain the valid ESData-protected Token(s) corresponding to the supplied Token-ID(s). The DAS Server shall provide only those Token(s) which are applicable to the Hosting CSE.
- Hosting CSE Processing:
 - 6.1 The Hosting CSE shall process the ESData-protected Token(s) to extract the authenticated Token(s). Additional checking shall also be applied. The Hosting CSE may cache the Token(s).
 - 6.2 The Hosting CSE may assign Local-Token-ID(s) to cached Token(s).
 - 6.3 The Hosting CSE shall perform the access decision, including the Token(s) identified in the request. If access is granted, then the requested operation shall be performed.
- Response:
 - 7.1 The Hosting CSE may send a response to the Originator. For each new Local-Token-ID(s) has been assigned, the Local-Token-ID and corresponding Token-ID shall be included in the ***Assigned Token Identifiers*** parameter of the response.
 - 7.2 The Originator shall associate the *Local-Token-ID* with Token-ID. In subsequent requests, the Originator may use the Local-Token-ID instead of the *Token* or Token-ID.

12 Information Recording

12.1 M2M Infrastructure Node (IN) Information Recording

12.1.0 Overview

Various informational elements have to be recorded by the M2M infrastructure nodes for a variety of reasons including but not limited to statistics, charging, maintenance, diagnostics, etc.

This clause describes a framework for recording the necessary information by infrastructure nodes.

12.1.1 Information Recording Triggers

Triggers have to be configured in the IN node by the M2M service provider to initiate information recording.

The M2M infrastructure nodes shall be able to initiate recording based on any of the following triggers:

- A request received by the M2M IN over the Mcc reference point.
- A request received by the M2M IN over the Mca reference point.
- A request initiated by the M2M IN over any reference point.
- Timer- based triggers for non- request based information recording. This trigger is used only when the memory size of a container over a period of time is required.

More than one trigger can be simultaneously configured.

The recording triggers may also be configurable, for example, as follows:

- On a per CSE basis, or a group of CSEs for requests originating/arriving from/at the M2M IN.
- On a per AE basis or a group of AEs.
- The default behaviour is that no CSEs/AEs are configured.

12.1.2 M2M Recorded Information Elements

12.1.2.1 Unit of Recording

A unit of recording refers to a number of informational elements recorded by the IN and that can be used as a basis for additional post-processing for a specific purpose such as generating Charging Data Records (CDRs), statistics, etc. In that respect, each unit of recording can be thought of as an M2M information record. The actual informational elements that make up a recording unit shall be described later.

For request-based triggers, as defined in clause 12.1.1, the unit of recording shall include a request and its response.

A unit of recording shall be referred to as an M2M Event Record. This shall apply to all recording triggers as defined in clause 12.1.1.

12.1.2.2 Information Elements within an M2M Event Record

The information elements within an M2M event record are defined in table 12.1.2.2-1.

Every M2M event record shall be tagged to depict its content according to the following classification:

- Data related procedures: represent procedures associated with data storage or retrieval from the M2M IN (e.g. Container related procedures).

- Control related procedures: represent all procedures that are not associated with data storage/retrieval from the M2M IN with the exclusion of group and device management related procedures (e.g. subscription procedures, registration).
- Group related procedures: represent procedures that handle groups. The group name may be derived from the target resource in these cases.
- Device Management Procedures.
- Occupancy based trigger for recording the occupancy as described in clause 12.1.1.

Table 12.1.2.2-1: Information Elements within an M2M Event Record

Information Element	For request based triggers Mandatory / optional	For timer based triggers Mandatory / optional	Description
<i>M2M Service Subscription Identifier</i>	M	M	The M2M Service Subscription Identifier associated with the request. This is inserted by the IN (see clause 12.1.3)
<i>Application Entity ID</i>	CM (when applicable)	NA	The M2M Application Entity ID if applicable
<i>External ID</i>	CM (when Applicable)	NA	The external ID to communicate over Mcn where applicable
<i>Receiver</i>	M	NA	Receiver of an M2M request (can be any M2M Node)
<i>Originator</i>	M	NA	Originator of the M2M request (can be any M2M Node)
<i>Hosting CSE-ID</i>	O	NA	The hosting CSE-ID for the request in case the receiver is not the host, where applicable
<i>Target ID</i>	M	NA	The target URL for the M2M request if available. Alternatively can be the target resource identifier
<i>Protocol Type</i>	O	NA	Used Protocol Binding (e.g. HTTP, CoAP, MQTT)
<i>Request Operation</i>	O	NA	Request Operation as defined in clause 8.1.2
<i>Request Headers size</i>	O	NA	Number of bytes for the headers in the Request (All Request parameters of the used protocol per the Protocol Type information element)
<i>Request Body size</i>	O	NA	Number of bytes of the body transported in the Request if applicable
<i>Response Headers size</i>	O	NA	Number of bytes for the headers in the Response (All Response parameters of the used protocol per the Protocol Type information element)
<i>Response Body size</i>	O	NA	Number of bytes of the body transported in the Response if applicable
<i>Response Status Code</i>	O	NA	
<i>Time Stamp</i>	M	M	Time of recording the M2M event
<i>M2M-Event-Record-Tag</i>	M	M	A Tag for the M2M event record for classification purposes. This tag is inserted by the IN and is M2M SP specific
<i>Control Memory Size</i>	O	NA	Storage Memory (in bytes), where applicable, to store control related information associated with the M2M event record(excludes data storage associated with container related operations)
<i>Data Memory Size</i>	O	NA	Storage Memory (in bytes), where applicable, to store data associated with container related operations
<i>Access Network Identifier</i>	O	O	Identifier of the access network associated with the M2M event record.
<i>Additional Information</i>	O		Vendor specific information
<i>Occupancy</i>	NA	M	Overall size (in Bytes) of the containers generated by a set of AEs identified by the M2M Service Subscription Identifier
<i>Group Name</i>	CM	NA	The Group name (not necessarily unique) shall be included by the IN-CSE in the case where the fanning operation is initiated by the M2M IN-CSE
<i>maxNrOfMembers</i>	O	NA	Maximum number of members of the group for Create and Update operation

Information Element	For request based triggers Mandatory / optional	For timer based triggers Mandatory / optional	Description
<i>currentNrOfMembers</i>	O	NA	Current number of members in a group. The request shall be logged and information elements shall be recorded from the request before processing it or sending it out. After obtaining corresponding response, <i>currentNrOfMembers</i> shall be updated with the values from the response
<i>Subgroup Name</i>	CM	NA	Subgroup name (not necessarily unique) shall be included i in the case when the IN-CSE initiates a fanning operation.
<i>M2M-Node-Id</i>	M	NA	The node Id for the node generating the Accounting-Record-Number for the Diameter ACR. This shall be set to the CSE-ID for the IN-CSE node

The choice for the mandatory elements is motivated by the need to include all M2M identifiers within an M2M event record so that it is possible to support multiple charging scenarios.

For all non-mandatory elements, the M2M IN shall be configurable by the M2M service provider to select any additional desired information to be recorded in addition to the mandatory elements.

12.1.3 Identities Associations in Support of Recorded Information

To enable the M2M IN to record the necessary information, as described above, the following associations shall be maintained by the M2M service provider:

- The CSE-ID (for all M2M Nodes in the M2M framework) and the allocated M2M Service Subscription Identifier.
- The AE-ID and the allocated M2M Service Subscription Identifier.

For established associations, as described above, the M2M IN shall derive the appropriate M2M Service Subscription Identifier for insertion in the M2M record event.

12.2 Offline Charging

12.2.1 Architecture

Figure 12.2.1-1 depicts the charging architecture. Charging information, in the form of charging data records (CDRs), shall be derived from recorded information, and transferred to a Charging Server. As such, it is essential that all information required for charging shall be first selected for recording. There shall be a 1 to 1 mapping between a M2M Event Record and a CDR.

The Charging Function (CHF included within the SCA CSF) embedded within the M2M IN is responsible for interaction with the Charging Server using the Mch reference point.

Billing aspects are out of scope.

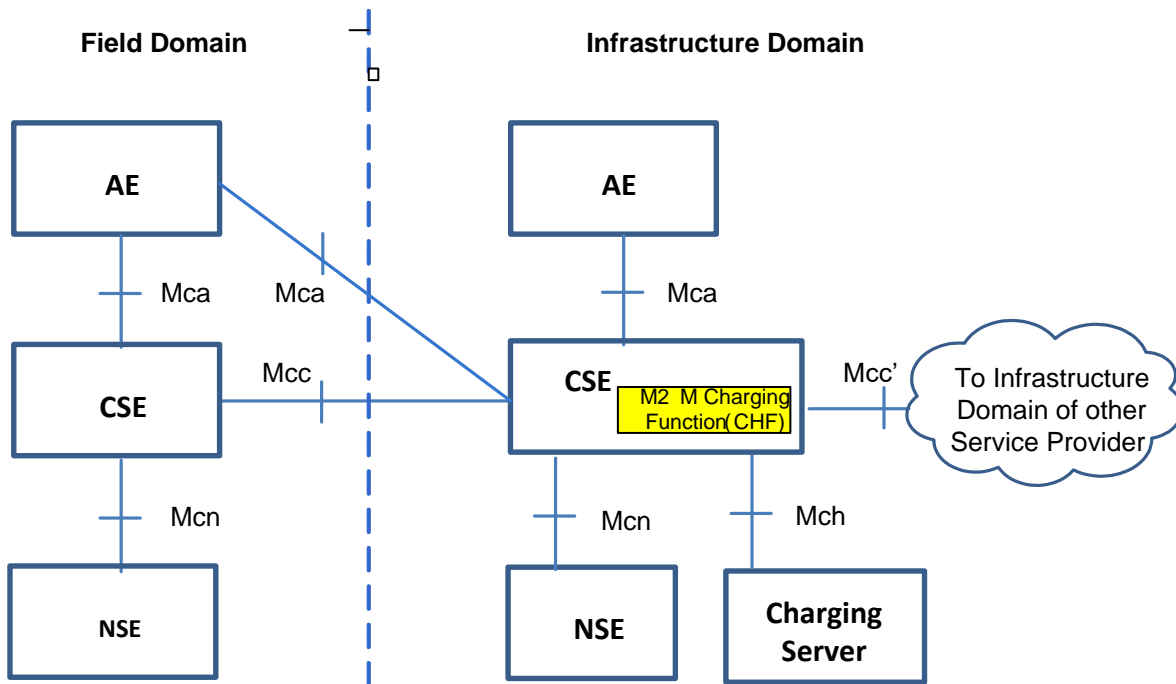

Figure 12.2.1-1: Offline Charging Architecture

Communication flows which transfer CDRs generated by the IN to an external charging server cross the Mch reference point. The Mch reference point may be mapped to reference points of other specifications. E.g. for a 3GPP Underlying Network, the Mch reference point maps to the Rf reference point enabling a 3GPP charging server to be used for oneM2M CDRs.

12.2.2 Filtering of Recorded Information for Offline Charging

Recorded information is the basis for offline charging. To fulfil the needs of different billing systems not all recorded information is required in all cases. Hence, the M2M Charging Function shall be configurable to only select the desired information from the recorded information for transfer to the Charging Server. This configuration shall support selecting the desired information based on the following capabilities:

- On a per CSE basis, or a group of CSEs, for requests originating/arriving from/at the IN. This applies to all M2M Nodes within the M2M framework.
- On a per AE basis or a group of AEs.
- The default behaviour is that no CSEs/AEs are configured.

The charging function shall ensure that information selected for transfer to the charging server has also been selected for recording before a configuration is deemed acceptable for execution.

12.2.3 Examples of Charging Scenarios

12.2.3.0 Overview

Charging scenarios refer to scenarios for which an M2M entity can be billed if the scenario is deemed billable by the M2M service provider. Some charging scenarios may require single CDR. Other scenarios may require multiple CDRs, and suitable correlation information shall have to be identified to select the CDRs for the charging scenario in this case.

The following clause lists some potential charging scenarios as examples only. Each scenario shall require the appropriate configuration of the CHF, and for that matter the M2M recording functions, to ensure that all pertinent data is available.

12.2.3.1 Example Charging Scenario 1 - Data Storage Resource Consumption

In this scenario, the M2M entity that stores application data, using container procedures for that purpose, will be billed, for storage resources within the M2M IN, until such time as the resources are deleted. This scenario will require correlation between multiple CDRs to identify the entity that stored the data, the entity that deleted the same data, and the duration and amount of storage.

12.2.3.2 Example Charging Scenario 2 - Data transfer

In this scenario, the M2M entity that retrieves/stores container data will be billed for the amount of transferred data.

12.2.3.3 Example Charging Scenario 3 - Connectivity

This scenario is relevant for an M2M entity that contacts the M2M IN frequently to transfer small amounts of data for storage. In this scenario, the M2M entity will be charged for the connectivity as opposed to the stored amount of data. The same applies to an M2M entity that also contacts frequently the M2M IN to retrieve stored data.

12.2.4 Definition of Charging Information

12.2.4.0 Overview

Charging information in the form of CDR is essentially a subset of the information elements within the M2M event records recorded by the M2M IN for transmission over the Mch reference point.

12.2.4.1 Triggers for Charging Information

The charging function within the M2M IN shall initiate transmission of CDRs if configured for that purpose in accordance with clause 12.2.2.

12.2.4.2 Charging Messages over Mch Reference Point

The Mch shall be used in case the CDRs are to be transferred to an external Charging Server. It is assumed that the Mch is equivalent to the Rf reference point as defined in [i.15] and [i.16].

Hence, every CDR shall be transferred in a single message, namely Accounting-Request and that elicits a response, namely Accounting-Answer.

The following table describes the use of these messages for offline charging.

Table 12.2.4.2-1: Offline charging messages reference table

Request-Name	Source	Destination	Abbreviation
Accounting-Request	M2M IN	Charging Server	ACR
Accounting-Answer	Charging Server	M2M IN	ACA

12.2.4.3 Structure of the Accounting Message Formats

12.2.4.3.1 Accounting-Request Message

Table 12.2.4.3.1-1 illustrates the basic structure of an ACR message generated from the M2M IN for offline charging in accordance with [i.15], [i.16], [i.8] and [i.11].

Table 12.2.4.3.1-1: Accounting-Request (ACR) message contents

Informational Element	Category	Description
Session-Id	M	This field identifies the operation session. The usage of this field is left to the M2M SP.
Origin-Host	M	This field contains the identification of the source point of the operation and the realm of the operation Originator.
Origin-Realm	M	This field contains the realm of the operation Originator.
Destination-Realm	M	This field contains the realm of the operator domain. The realm will be addressed with the domain address of the corresponding public URI.
Accounting-Record-Type	M	This field defines the transfer type: This field shall always set to event based charging.
Accounting-Record-Number	M	This field contains the sequence number of the transferred messages.
Acct-Application-Id	O _C	Advertises support for accounting for M2M.
Origin-State-Id	O _C	This is a monotonically increasing value that is advanced whenever a Diameter entity restarts with loss of previous state, for example upon reboot.
Event-Timestamp	O	Defines the time when the event occurred.
Destination-Host	O _C	This is the intended destination for the message
Proxy-Info	O _C	Includes host information about a proxy that added information during routing of the message.
Route-Record	O _C	This field contains an identifier inserted by a relaying or proxying charging node to identify the node it received the message from.
Service-Context-Id	M	This field identifies the M2M domain.
Service-Information	M	This is a grouped field that holds the M2M specific parameters.
Subscription-Id	M	Identifies the M2M Service Subscription Identifier.
M2M Information	M	This parameter holds the M2M informational element specified in table 12.1.2.2-1 with the exception of the M2M Service Subscription Identifier.
Proprietary information	O	This is for proprietary information.
O _C		This is a parameter that, if provisioned by the service provider to be present, shall be included in the CDRs when the required conditions are met. In other words, an O _C parameter that is configured to be present is a conditional parameter.

12.2.4.3.2 Accounting-Answer Message

Table 12.2.4.3.2-1 illustrates the basic structure of an ACA message generated by the charging server as a response to an ACR message.

Table 12.2.4.3.2-1: Accounting-Answer (ACA) message contents

Information element	Category	Description
Session-Id	M	Same as table 12.2.4.3.1-1
Origin-Host	M	Same as table 12.2.4.3.1-1
Origin-Realm	M	Same as table 12.2.4.3.1-1
Accounting-Record-Type	M	Same as table 12.2.4.3.1-1
Accounting-Record-Number	M	Same as table 12.2.4.3.1-1
Acct-Application-Id	O _C	Same as table 12.2.4.3.1-1
Origin-State-Id	O _C	This is a monotonically increasing value that is advanced whenever a Diameter entity restarts with loss of previous state, for example upon reboot
Event-Timestamp	O	Same as table 12.2.4.3.1-1
Proxy-Info	O _C	Same as table 12.2.4.3.1-1
Proprietary Information	O	Same as table 12.3.4.3.1-1
Result-Code	M	Indicates whether a particular request was completed successfully or whether an error occurred
O _C		This is a parameter that, if provisioned by the operator to be present, shall be included in the CDRs when the required conditions are met. In other words, an O _C parameter that is configured to be present is a conditional parameter.

Annex A (informative): Mapping of Requirements with CSFs

Table A-1 illustrates the mapping of the Requirements specified in oneM2M TS-0002 [i.1] with the CSFs specified in the present document.

Table A-1: Mapping of Requirements to CSFs

CSF Name	Supported Sub-Functions	Associated Requirements	Notes
Addressing and Identification (AID)	<ul style="list-style-type: none"> Management of identifiers 	OSR-026 OSR-023 OSR-024 OSR-025	Overlap w/ DIS for OSR-023, OSR-024, and OSR-025
Communication Management/Delivery Handling (CMDH)	<ul style="list-style-type: none"> Providing communications with other CSE's, AE's, and NSE's Communications management: best effort Communications policy management Underlying Network connectivity management Communications management: data store and forward Ability to trigger off-line device 	OSR-001 OSR-002 OSR-005 OSR-006 OSR-008 OSR-009 OSR-012 OSR-013 OSR-014 OSR-015 OSR-018 OSR-019 OSR-021 OSR-027 OSR-032 OSR-035 OSR-038 OSR-039 OSR-040 OSR-048 OSR-049 OSR-050 OSR-053 OSR-062 OSR-063 OSR-064 OSR-065 OSR-066 OSR-067 OSR-068 CRPR-001 CRPR-002 CRPR-003 MGR-016	Overlap w/ DMR for OSR-001, OSR-009, OSR-021, OSR-032 SSM for OSR-009 LOC for OSR-006 GMG for OSR-006 NSSE for OSR-006, OSR-027 SSM for OSR-009
Data Management and Repository (DMR)	<ul style="list-style-type: none"> Data storage and management Semantic support Data aggregation Data analytics Device data backup and recovery 	OSR-001 OSR-007 OSR-009 OSR-016 OSR-020 OSR-021 OSR-032 OSR-034 OSR-036 OSR-058 SMR-006 SER-015	Overlap w/ CMDH for OSR-001, OSR-009, OSR-021, OSR-032 SUB for OSR-016 GMG for OSR-020

CSF Name	Supported Sub-Functions	Associated Requirements	Notes
Device Management (DMG)	<ul style="list-style-type: none"> Configuration Management Diagnostics and Monitoring Firmware management Software management Device Area Network topology management 	OSR-017 OSR-069 OSR-070 OSR-071 OPR-001 OPR-002 OPR-003 MGR-001 MGR-003 MGR-004 MGR-006 MGR-007 MGR-008 MGR-009 MGR-011 MGR-012 MGR-013 MGR-014 MGR-015 MGR-019 MGR-020 MGR-021 SER-013 SER-014	Overlaps w/: GMG for OSR-017 SEC for SER-013
Discovery (DIS)	<ul style="list-style-type: none"> Discover resource Local discovery (within CSE) Directed remote discovery 	OSR-023 OSR-024 OSR-025 OSR-059 OSR-060 OSR-061 MGR-002 SMR-004	Overlaps w/: AID for OSR-023, OSR-024, OSR-025
Group Management (GMG)	<ul style="list-style-type: none"> Management of a group and its membership CRUD Use Underlying Network group capabilities Bulk operations Access control 	OSR-006 OSR-017 OSR-020 OSR-029 OSR-030 OSR-031 OSR-037 OSR-047 MGR-005	Overlaps w/: CMDH for OSR-006 LOC for OSR-006 GMG for OSR-006 NSSE for OSR-006, OSR-037 DMR for OSR-020 DMG for OSR-017
Location (LOC)	<ul style="list-style-type: none"> Location management Network-provided GPS-provided Confidentiality enforcement as it relates to location 	OSR-006 OSR-051 OSR-052 SER-026	
Network Service Exposure /Service execution and triggering (NSSE)	<ul style="list-style-type: none"> Access Underlying Network service Location Device triggering Small data Policy and charging Support multiple Underlying Network functions 	OSR-006 OSR-011 OSR-027 OSR-037 OSR-054 OSR-055 OSR-056 MGR-017 MGR-018 OPR-004 OPR-005 OPR-006	Overlaps w/: CMDH for OSR-027 GMG for OSR-006, OSR-037 LOC for OSR-006
Registration (REG)	<ul style="list-style-type: none"> CSE registration Application registration Device registration ID correlation 	MGR-010	Overlaps w/: SEC

CSF Name	Supported Sub-Functions	Associated Requirements	Notes
Security (SEC)	<ul style="list-style-type: none"> • Sensitive Data Handling • Secure storage • Secure execution • Independent environments • Security administration • Pre-provisioning • Dynamic bootstrap • Network bootstrap • Security association • Link level • Object level • Authorization and access • Identity protection 	SER-001 SER-002 SER-003 SER-004 SER-005 SER-006 SER-007 SER-008 SER-009 SER-010 SER-011 SER-012 SER-013 SER-016 SER-017 SER-018 SER-019 SER-020 SER-021 SER-022 SER-023 SER-024 SER-025 MGR-010	Overlap w/ DMG for SER-013 REG for MGR-010 SSM for SER-007
Service Charging and Accounting (SCA)	<ul style="list-style-type: none"> • Charging enablers • Sending charging information to charging server • Subscription-based charging • Event-based charging • Session-based charging • Service-based charging • Correlation with Underlying Network • Charging management • Offline charging • Online charging 	CHG-001, CHG-002a, CHG-002b, CHG-003, CHG-004, CHG-005	
Service Session Management (SSM)	<ul style="list-style-type: none"> • Service Session Management (CSE to CSE, AE to CSE, and AE to AE) • Session persistence over link outage • Session context handling • Assignment of session ID • Session routing • Multi-hop session management • Session policy management 	OSR-003 OSR-004 OSR-009 OSR-045 SER-007	Overlap w/ CMDH and DMR for OSR-009 SEC for SER-007
Subscription/Notification Support (SUB)	<ul style="list-style-type: none"> • Subscribe (CSE, AE) • Local • Remote • Subscription to a group • Notification • Synchronous • Asynchronous 	OSR-010 OSR-016 OSR-033	Overlaps w/ DMR for OSR-016

Annex B (informative): oneM2M System and 3GPP MTC Underlying Network Interworking

B.1 3GPP MTC Underlying Network Introduction

In order to provide end-to-end M2M services, interworking between oneM2M System and the 3GPP Underlying Network is required. This entails the following aspects:

- Connectivity establishment between the IN-CSE and the CSE at the M2M/MTC device/Gateway in the 3GPP Underlying Network for the following two cases.
- ASN/MN-CSE initiated connectivity establishment when the device/GW has lost connectivity with the Underlying Network and needs to send data to the AE.
- IN-CSE initiated triggering for cases when the ASN/MN-CSE needs to be contacted by the IN-CSE.
- Mapping of oneM2M and 3GPP Identifiers to assist the specific entities on the two system in connectivity establishment.

This annex provides system level information on the above aspects specifically related to the interworking i.e. connectivity between the oneM2M System and the 3GPP Underlying Network.

B.2 3GPP MTC Functionality

B.2.1 3GPP Release-11 MTC Functionality

Interworking with oneM2M Release-1 is based on 3GPP Release-11 specifications. The relevant 3GPP Release-11 specification references are as follows:

- 3GPP TS 23.682 [i.14]: Architecture Enhancements to facilitate Communication with Packet Data Networks and Applications;
- 3GPP TS 23.401 [i.19]: GPRS Enhancements for E-UTRAN Access;
- 3GPP TS 23.402 [i.20]: Architecture Enhancements for non-3GPP Accesses;
- 3GPP TS 23.060 [i.21]: General Packet Radio Service (GPRS) Service Description;
- 3GPP TS 22.368 [i.22]: Service requirements for Machine Type Communications (MTC); Stage 1.

In annex A of 3GPP TS 23.682 [i.14] the following MTC deployment scenarios are depicted on which the oneM2M entities are mapped.

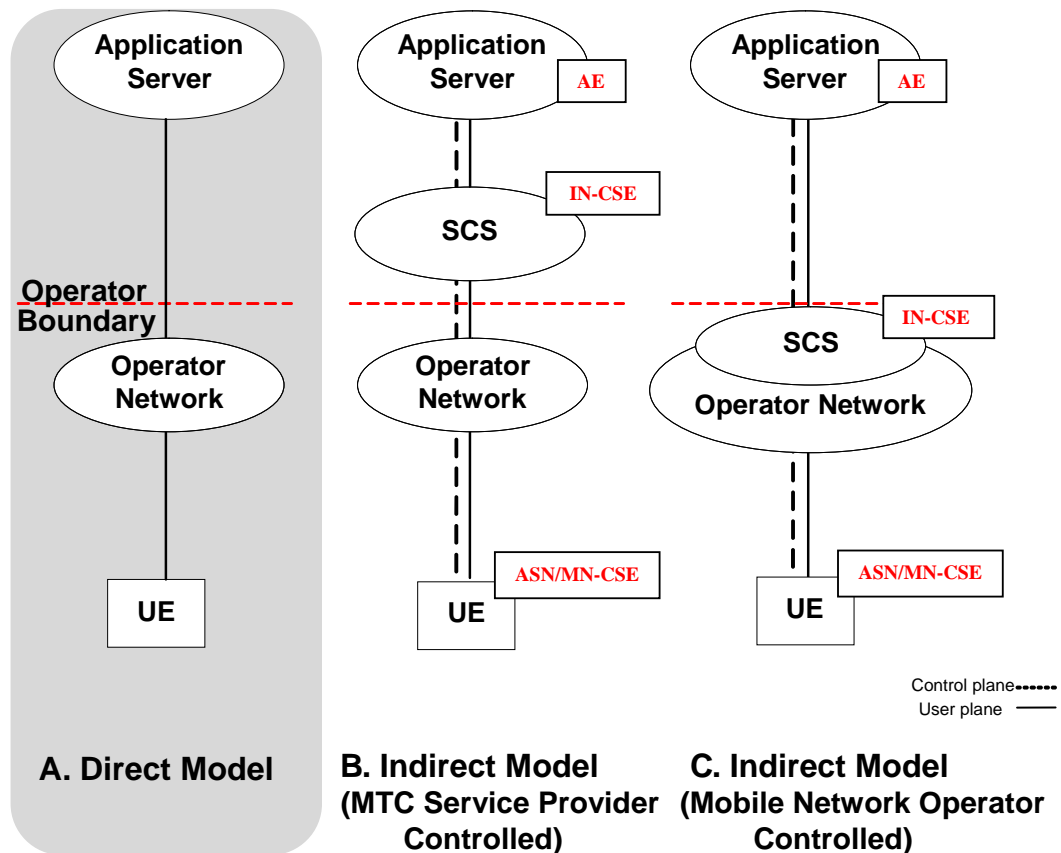

Figure B.2.1-1: MTC deployment scenarios for Direct and Indirect model

The focus of this Annex is on deployment scenario B (Indirect Model), where the M2M (or MTC in 3GPP nomenclature) Services Capability Server (SCS) is outside the 3GPP operator domain. The indirect model, scenario C in figure B.2.1-1, where the M2M SCS is inside the 3GPP operator domain is also not ruled out.

Hybrid model which is a combination of above scenario B and C is also mentioned in 3GPP TS 23.682 [i.14] which may also be supported but is not shown here.

Taking 3GPP Release-11 MTC network as the Underlying Network, oneM2M IN-CSE is considered as equivalent to or part of the SCS, and oneM2M ASN/MN-CSE is considered equivalent to a UE. The mapping of oneM2M entities to 3GPP entities is shown in figure B.2.1-2.

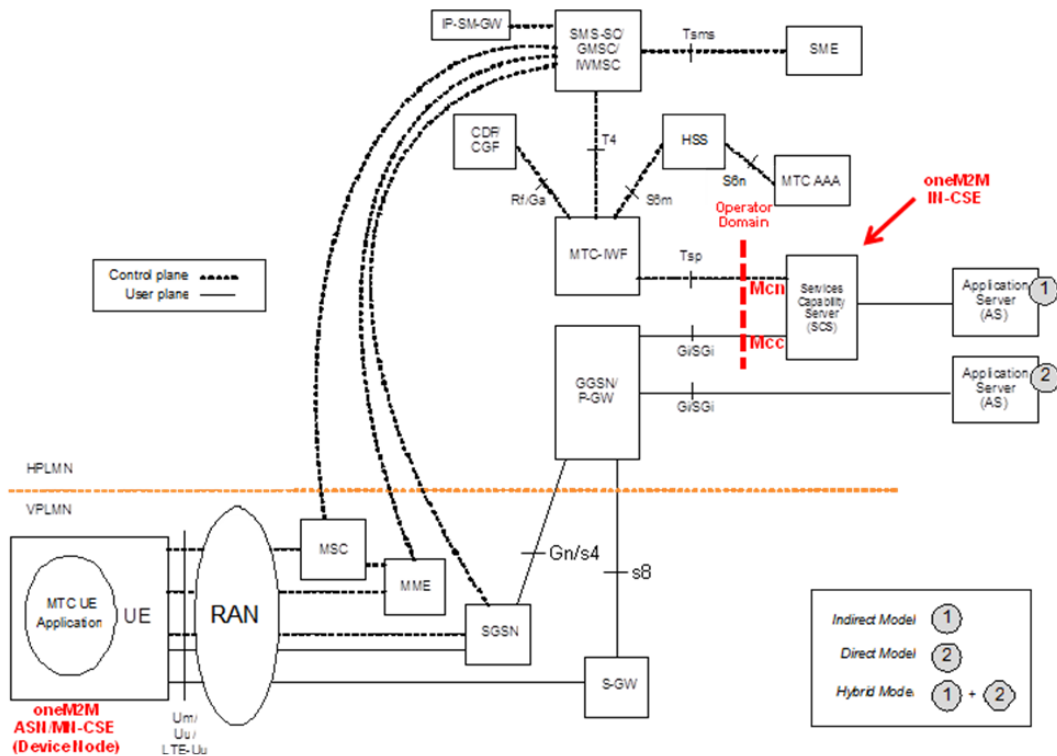

Figure B.2.1-2: Mapping of oneM2M entities to the 3GPP Architecture for Machine-to-Machine Communications

The IN-CSE can be inside or outside the 3GPP operator domain and interacts with the 3GPP Underlying Network via MTC-IWF and/or GGSN/P-GW. This requires mapping of oneM2M reference points (Mcn, Mcc) to 3GPP reference points (Tsp, Gi/SGi), along with the mapping of the identifiers in the two systems.

B.2.2 3GPP Release-13 MTC Interworking

B.2.2.1 General overview of 3GPP Release-13 MTC Interworking

3GPP MTC Interworking for oneM2M Release-2 is based on 3GPP Release-13 specifications. The relevant 3GPP Release-13 specification references are as follows:

- 3GPP TS 23.682 [i.14]: Architecture Enhancements to facilitate Communication with Packet Data Networks and Applications (Release 13);
- 3GPP TS 22.101 [i.29]: Service aspects; Service principles (Release 13) clause 29;
- 3GPP TS 22.115 [i.30]: Service aspects; Charging and billing (Release 13) sub-clause 5.1.3.

The Release 13 version of 3GPP TS 23.682 [i.14] specification includes two different architectures. One is for the "MTC Device triggering" feature mentioned in Annex B.2.1 and was specified in 3GPP release 11. The other one is the Service Capability Exposure Function (SCEF) for 3GPP Service exposure with 3rd party service providers features newly provided in Release 13 which is the focus of the present Annex B.2.2. Refer to the following figure B.2.2.1-1 and B.2.2.1-2, taken from the release 13 version of 3GPP TS 23.682 [i.14].

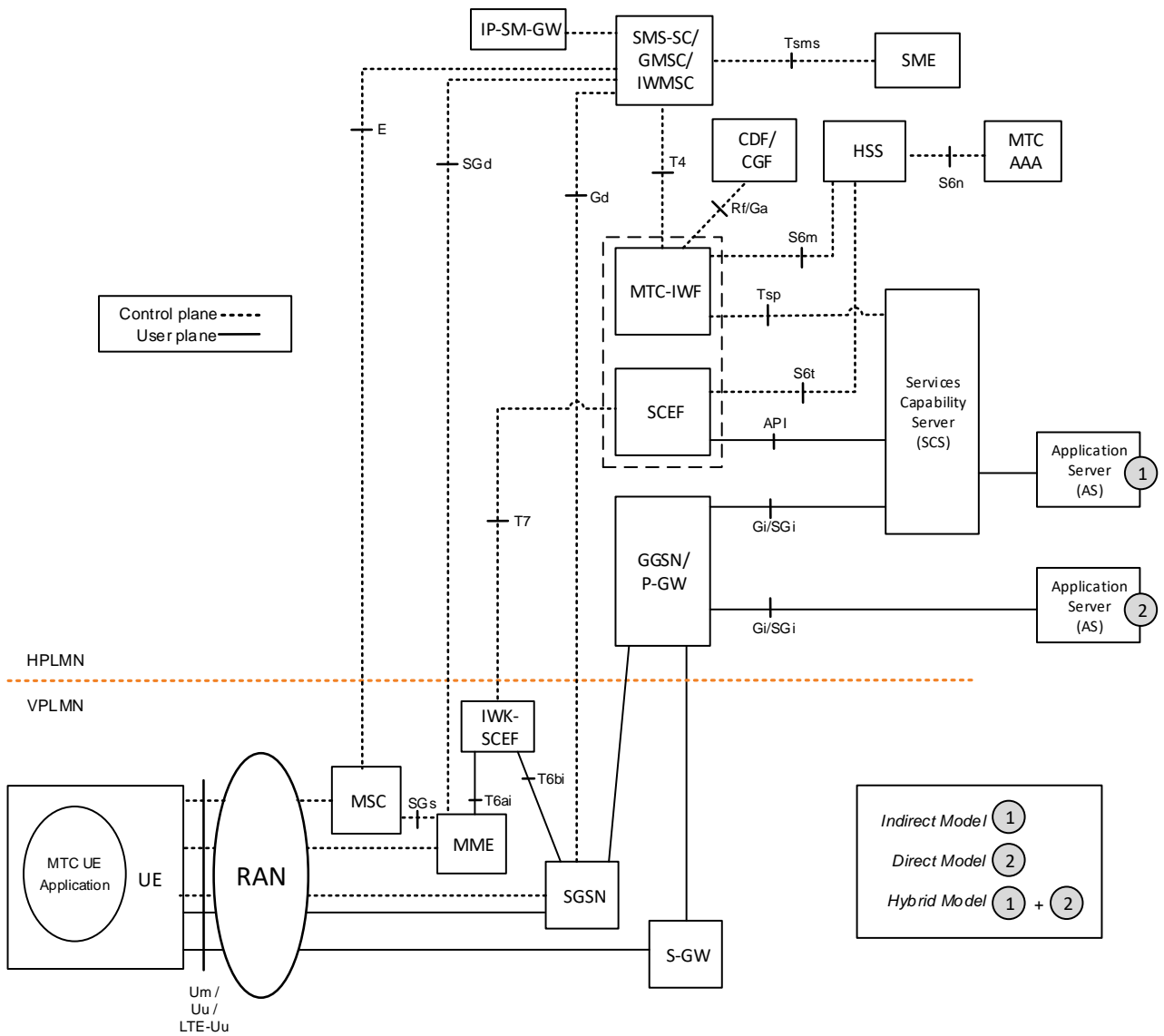

Figure B.2.2.1-1: 3GPP R13 Architecture for Machine-Type Communication

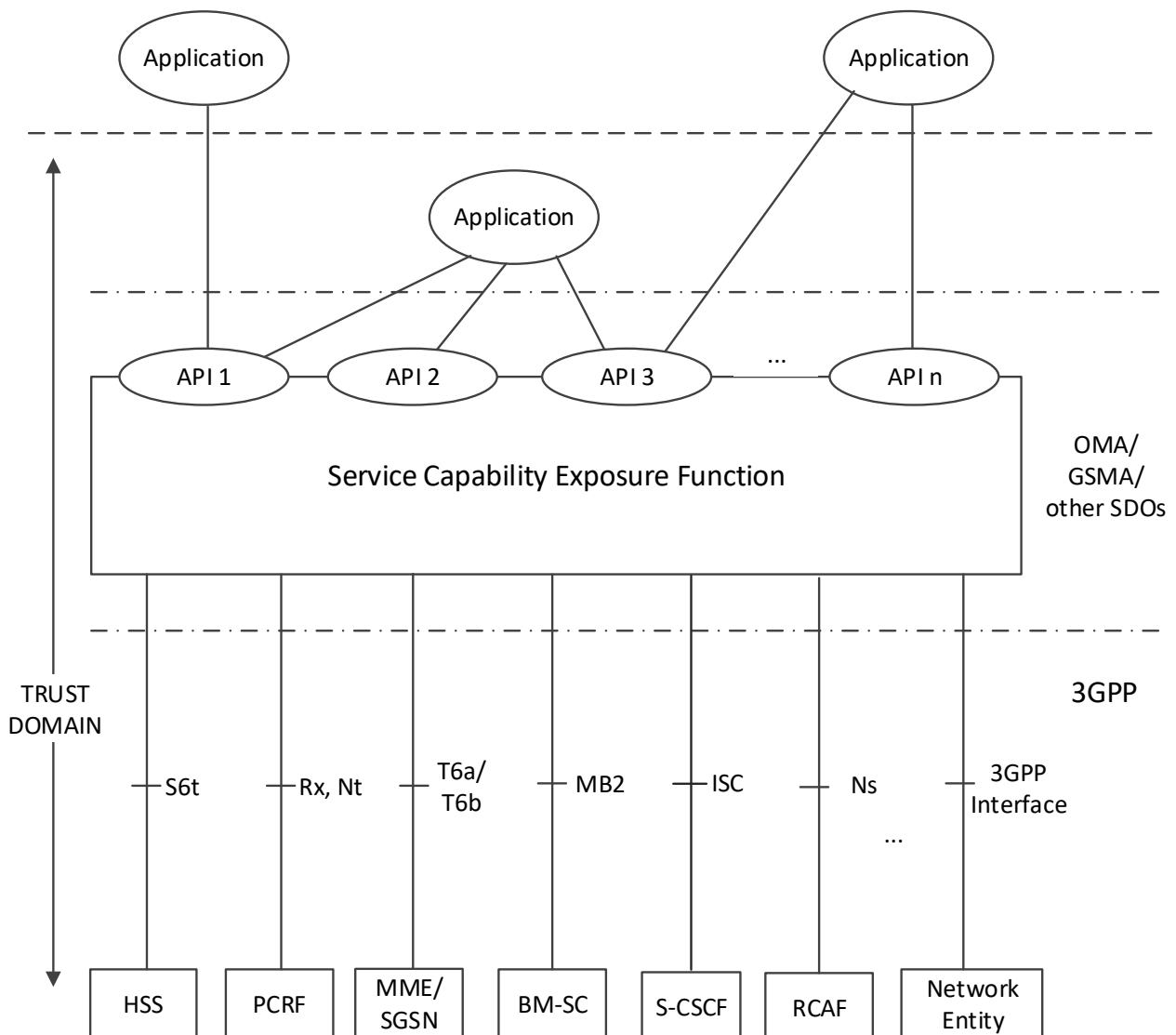

Figure B.2.2.1-2: 3GPP Architecture for Service Capability Exposure

While 3GPP release 13 specifies the Service Capability Exposure Function (SCEF) as a 3GPP entity, residing in the trust domain of the 3GPP operator, 3GPP does not specify the APIs exposing these functions. Specification of these APIs is expected by external SDOs, e.g. OMA. As described in 3GPP TS 23.682 [i.14], the SCEF covers services such as the ability to as below:

- configuration of device communication patterns;
- the QoS of a data flow;
- sponsor a data flow;
- scheduling data transfers;
- monitor a device's state;
- optimizing a device's communication patterns for high latency applications;
- receive reports about the condition of the mobile core network;
- trigger devices;
- send group messages via MBMS;
- Non-IP Data Delivery (NIDD).

B.2.2.2 3GPP Release-13 MTC feature for Configuration of Device Communication Patterns

oneM2M uses the 3GPP Release-13 MTC feature for Configuration of Device Communication Patterns to configure Node Traffic Patterns in the Underlying Network (see clause 8.3.5 Configuration of Node Traffic Patterns). To that purpose the IN-CSE translates the oneM2M Node Traffic Pattern (TP) into a 3GPP Device Communication Pattern.

A signalling sequence for provisioning of CP parameters is described in the clause 5.10.2 of 3GPP TS 23.682 [i.14]. Following figure B.2.2.2-1 provides the signalling sequence derived from the 3GPP specification. Figure B.2.2.2-2 illustrates the terminology mapping between 3GPP and oneM2M, where the SCS is mapped to IN-CSE and the SCEF is mapped to NSE. In case the SCS is 3GPP network operator controlled, the SCEF can be deployed co-located with the SCS.

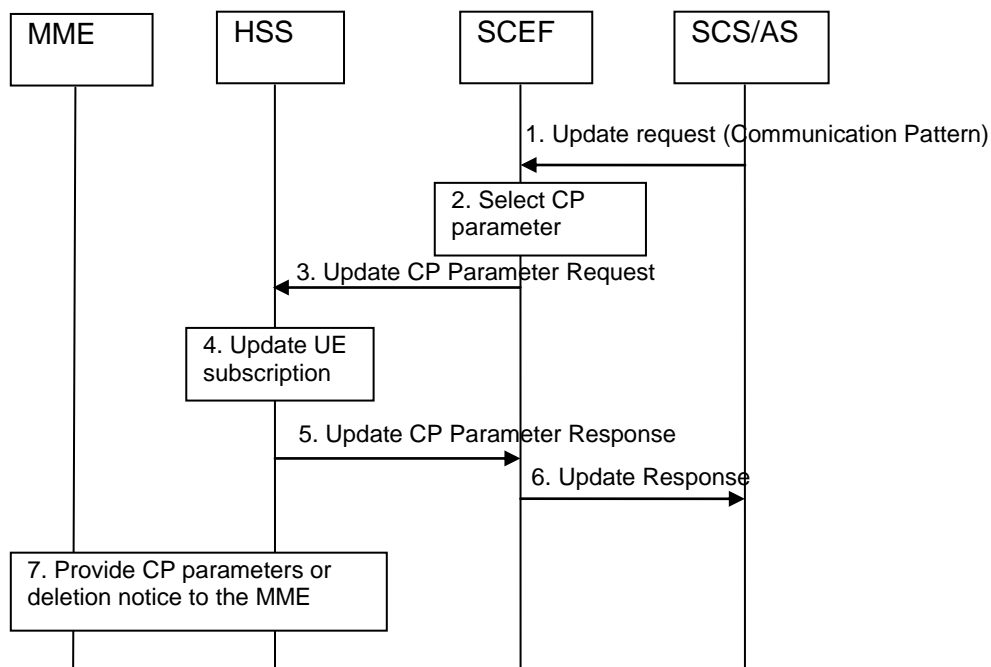

Figure B.2.2.2-1: Signalling sequence for provisioning of CP Parameters

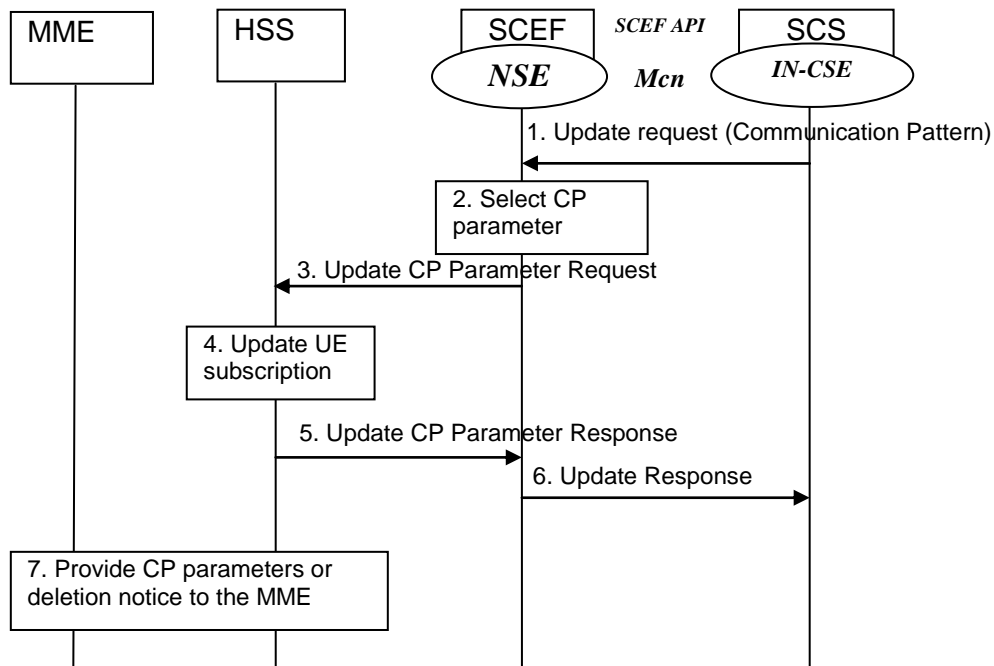

Figure B.2.2.2-2: 3GPP and oneM2M mapping

3GPP TS 23.682 [i.14] defines the request message of step 1 as below:

- The SCS/AS sends an Update Request (External Identifier or MSISDN, SCS/AS Identifier, SCS/AS Reference ID(s), CP parameter set(s), validity time(s), SCS/AS Reference ID(s) for Deletion) message to the SCEF.

NOTE 1: The SCS/AS uses this procedure to add, change or delete some or all of the CP parameter sets of the UE, e.g. if the AS is aware that the UE has started or stopped moving for a significant time period, especially if the AS is instructing the UE to do so, then the SCS/AS provides the corresponding CP parameter set(s) and its validity time to the SCEF. The interface between SCEF and SCS/AS is outside the scope of 3GPP and the messages in the Figure are exemplary.

3GPP TS 23.682 [i.14] defines the request message of step 3 as below:

- The SCEF sends Update CP Parameter Request (External Identifier or MSISDN, SCEF Reference ID(s), SCEF Address, CP parameter set(s), validity time(s), SCEF Reference ID(s) for Deletion) messages to the HSS for delivering the selected CP parameter set(s) per UE. There may be multiple CP parameter sets included in this message where each CP parameter set for addition or modification has been determined to be non-overlapping with other CP parameter sets either included in the message or already provisioned for a given UE. The SCEF derives the SCEF Reference (IDs) for CP parameter sets to be sent to the HSS based on the SCS/AS Reference ID(s) from the SCS/AS.

NOTE 2: A request for deletion of a CP parameter set from the SCS/AS may result in a request for modification of the non-overlapping CP parameter set by the SCEF.

EXAMPLE 1: In the case that the selected server NSE is a 3GPP HSS, the protocol of the S6t reference point defined by 3GPP is used for the request. The S6t uses one of Diameter Application protocols defined by 3GPP. The request on the S6t reference point for the configuration of the CP parameter sets (a CIR command) includes a User-Identifier AVP (either an External Identifier or a MSISDN of the UE), may include one or more AESE-Communication-Pattern AVP. An AESE-Communication-Pattern AVP includes a SCEF-ID AVP (represent the ID of the IN-CSE or M2M-SP-ID), may include a SCEF-Reference-ID AVP (assigned by the IN-CSE or M2M-SP to identify the configuration of CP parameter sets uniquely), may include one or more Communication-Pattern-Set AVP. A Communication-Pattern-Set AVP may include AVPs for Periodic-Communication-Indicator, Communication-Duration-Time, Periodic-Time, one or more Scheduled-Communication-Time, Stationary-Indication, and Validity-Time. Refer to the 3GPP TS 29.336 [i.31] for the detailed protocol description.

3GPP TS 23.682 [i.14] defines the response message of step 5 as below:

- The HSS sends Update CP Parameter Response (SCEF Reference ID, Cause) message to the SCEF. The cause value indicates successful subscription update or the reason of failed subscription update.
- The actual parameters for the request and response messages in above steps 3 and 5 are defined by 3GPP TS 29.336 [i.31], clauses 7 and 8 for S6t reference point.

EXAMPLE 2: In the case that the selected server NSE is a 3GPP HSS, the protocol of the S6t reference point defined by 3GPP is used for the response. The response on the S6t reference point for the configuration of the CP parameter sets (a CIA command) includes either Result-Code AVP or Experimental-Result AVP, may include a User-Identifier AVP if successful case, may include one or more AESE-Communication-Pattern-Config-Status AVP. An AESE-Communication-Pattern-Config-Status AVP includes the SCEF-Reference-ID AVP (same value in the request), may include the SCEF-ID (same value in the request) and an AESE-Error-Report AVP. Refer to the 3GPP TS29.336 for the detailed protocol description.

3GPP TS 23.682 [i.14] defines the response message of step 6 as below:

- The SCEF sends the Update Response (SCS/AS Reference ID, Cause) message to inform the SCS/AS whether the provision of the CP parameter set(s) was successful.

B.3 ASN/MN-CSE initiated connectivity establishment

B.3.0 Overview

It is assumed that there is no connectivity previously established, i.e. no association between the ASN/MN-CSE and the serving IN-CSE exists. When the ASN/MN-CSE needs to send data to the serving IN-CSE it first discovers the serving IN-CSE, which is located in a packet data network, and establishes connection. Two methods can be used, as follows:

- Use of DHCP and DNS.
- Pre-configuration.

B.3.1 Use of DHCP and DNS

The ASN/MN-CSE requests the DNS server address from the DHCP server followed by requesting the serving IN-CSE IP address from the DNS server.

NOTE: How a non-CSE capable M2M device (e.g. ADN) interworks with the 3GPP Underlying Network is not specified in this release of the document.

B.3.2 Pre-configuration

The ASN/MN-CSE is preconfigured with the fully qualified domain name (FQDN) of the serving IN-CSE or the IP address of the serving IN-CSE. If the FQDN is known, DNS resolution is used to obtain the IP address.

B.4 Serving IN-CSE initiated connectivity establishment

It is assumed that there is no connectivity previously established between the ASN/MN-CSE and the serving IN-CSE. When the serving IN-CSE needs to contact the ASN/MN-CSE to send data or request data, connectivity between them is established. This connectivity is triggered by the serving IN-CSE.

NOTE: How the serving IN-CSE triggers a non-CSE capable M2M device (e.g. ADN) within the 3GPP Underlying Network is not specified in this release of the document.

B.5 Connectivity between oneM2M Service Layer and 3GPP Underlying Network

ASN/MN-CSE communicates with the serving IN-CSE after completion of the Underlying Network bearer establishment and discovery of the serving IN-CSE. Data can then traverse between CSEs over the IP connection in the Underlying Network over 3GPP Gi/SGi interface. In addition, the signalling connectivity between the two CSEs is also realized. Figure B.5-1 depicts the connectivity between the ASN/MN-CSE and the IN-CSE.

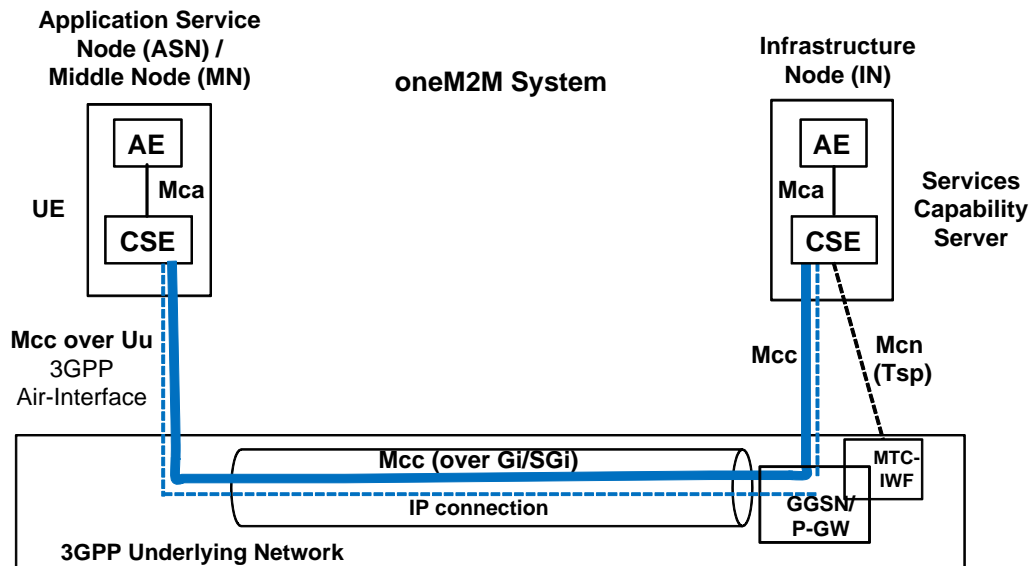

Figure B.5-1: Connectivity Establishment between ASN/MN-CSE and IN-CSE

B.6 Connectivity Establishment Procedures

B.6.1 General

B.6.1.0 Overview

When data is to be exchanged between the ASN/MN-CSE and the IN-CSE, connectivity between them needs to be established. The need for this connectivity can arise for two reasons:

- 1) ASN/MN-CSE initiated: When the ASN/MN-CSE needs to send/receive data to/from the IN-CSE; or
- 2) IN-CSE initiated: When the IN-CSE needs to send/receive data to/from the ASN-CSE (known as device triggering).

Connectivity establishment procedures in this clause are example illustrations and do not exclude other realizations.

B.6.1.1 ASN/MN-CSE Initiated Connectivity Establishment Procedure

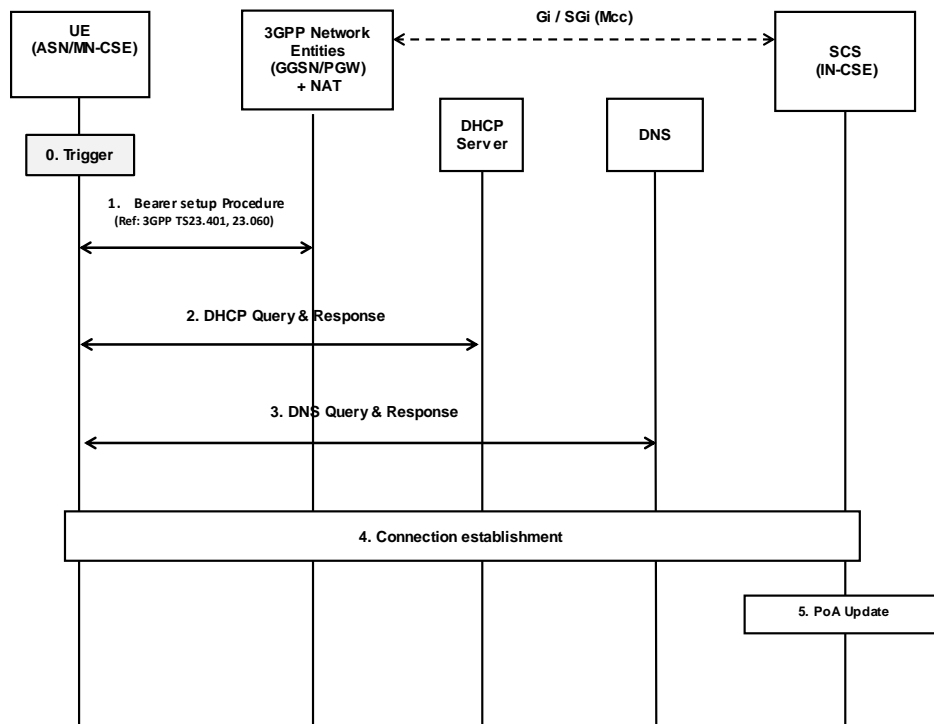

Figure B.6.1.1-1: ASN/MN-CSE initiated connectivity establishment

Step-0: Trigger

Subsequent procedures are triggered either when the ASN/MN-CSE powers on or resulting from Device Triggering mentioned in clause B.6.1.2.

Step-1: Bearer Setup Procedure

Establish a 3GPP bearer(s) if not already available by using the procedures available in the 3GPP network.

Step-2: DHCP Query & Response

The ASN/MN-CSE sends a query to a DHCP server to find a particular DNS server IP address. The DHCP server responds with the IP address of a corresponding DNS server. Additionally, it is also possible to include one or a list of domain names, i.e. FQDNs of target IN-CSEs.

Step-3: DNS Query & Response

The ASN/MN-CSE performs a DNS query to retrieve the IN-CSE(s) IP addresses from which one is selected. If the response does not contain the IP addresses, an additional DNS query is needed to resolve a Fully Qualified Domain Name (FQDN) of the serving IN-CSE to an IP address.

Step-4: Connection Establishment

After reception of domain name and IP address of an IN-CSE, the ASN/MN-CSE can initiate communication towards the IN-CSE via the IP connection. The IN-CSE at this time is informed which Trigger Recipient ID of the ASN/MN-CSE to use for establishing communication.

Step-5: CSE-PoA Update

Once the M2M Service Connection (Mcc) is established, in the IN-CSE the CSE-PoA of the ASN-CSE/MN-CSE will be updated with the new established IP address.

The IN-CSE holds the state information and needs to be informed when the connection is closed.

B.6.1.2 IN-CSE initiated connectivity establishment procedure over Tsp

Connection Establishment between IN-CSE and ASN/MN-CSE

Whenever the IN-CSE requires to establish a connection towards another entity (e.g. ASN/MN-CSE), Device Triggering procedure over the Tsp interface as described in 3GPP TS 23.682 [i.14] is used.

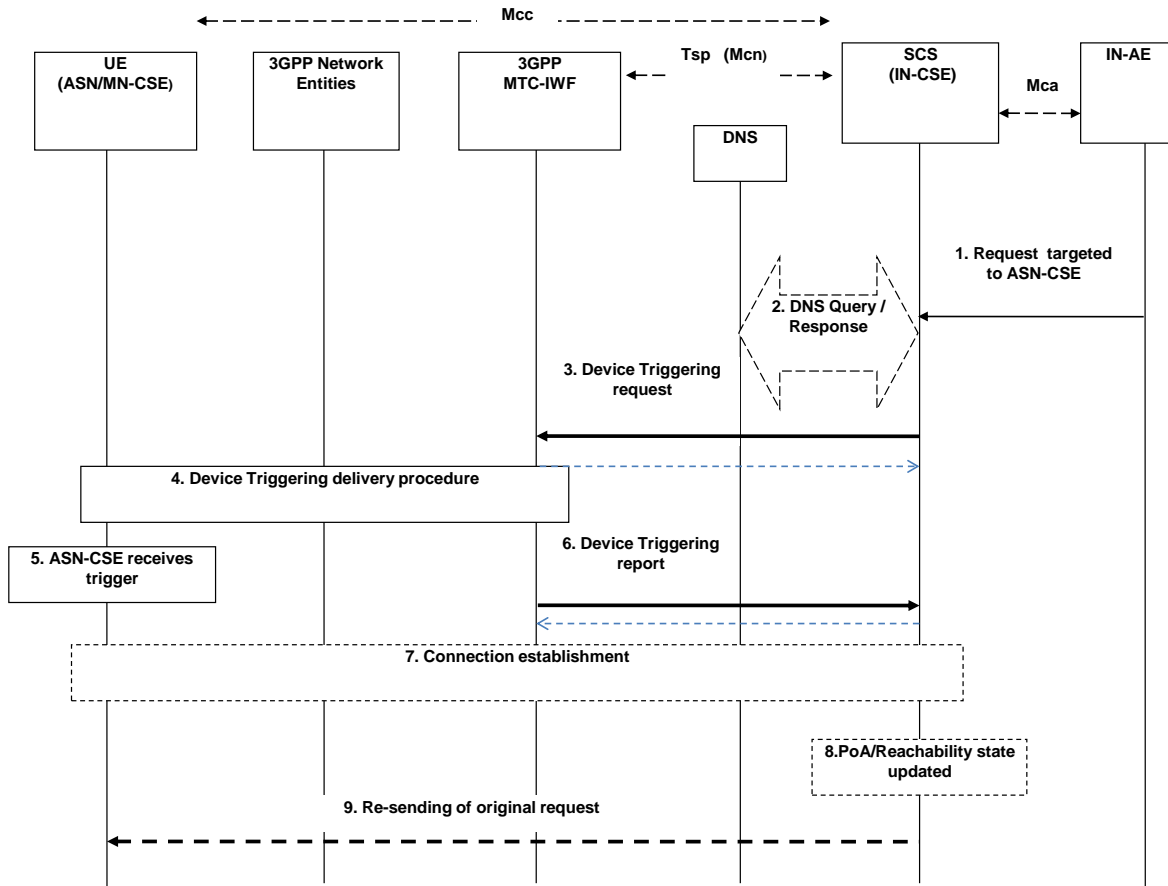

Figure B.6.1.2-1: IN-CSE initiated connectivity establishment

Pre-condition

The CSE which is the target of the device triggering has to be registered with the IN-CSE. The IN-CSE checks the state information of the target device. Some of this state information is the result of a previous connection establishment or triggering requests, such as the case of power-off, dormant and/or connected state. The IN-CSE decides its next action, e.g. if it needs to start device triggering or to report to IN-AE about the inability to perform the request.

The CSE-PoA for the ASN/MN-CSE either already contain an IP address which is not valid anymore or no IP address at all, or FQDN does not resolve to a valid IP address. This is a pre-requisite for performing the device triggering procedure.

Step 1 (Optional): Request targeted to ASN/MN-CSE

The IN-AE requests to perform one of the CRUD operation on a resource residing on the ASN/MN-CSE, the request is sent via the Mca reference point to the IN-CSE. The request from IN-AE includes the address of the target resource.

Step 2: DNS Query/Response

The IN-CSE determines the need to trigger the ASN/MN-CSE.

If the IN-CSE has no contact details for a contact MTC-IWF, it may determine the IP address(es)/port(s) of the MTC-IWF by performing a DNS query using the M2M-Ext-ID (M2M External Identifier) assigned to the target ASN/MN-CSE, or using a locally configured MTC-IWF identifier.

Step-3: Device Triggering Request

The IN-CSE buffers the original request information and sends the Device Trigger Request message that contains information as specified in 3GPP TS 23.682 [i.14]. Such information includes:

- M2M-Ext-ID or MSISDN.
- SCS-Identifier, (is set to the IN-CSE ID).
- Trigger reference number (used to correlate the request with the response).
- Validity period, (which indicates how long the request is valid).
- Priority (this field allows to set the priority on or off).
- Application Port ID, (is set to the ASN/MN-CSE Trigger-Recipient-ID since it is the triggering application addressed in the device from 3GPP point of view).
- Trigger payload, (optional information can be set to the payload).

NOTE 1: In case that the Device Triggering request is for an M2M Service Connection setup request as in the present flow, it is assumed that when the target CSE (i.e. ASN/MN-CSE) is woken up on receiving the trigger it initiates connection establishment with the IN-CSE with which it is registered. The information of the IN-CSE may be pre-stored in the target CSE (i.e. ASN/MN-CSE) or obtained from the payload.

Acknowledge

Once, 3GPP-MTC-IWF receives the Trigger Request, it asks the HSS to determine if the IN-CSE is authorized to perform the triggering to the target CSE (i.e. ASN/MN-CSE) and the HSS resolves the M2M-Ext-ID to IMSI (or MSISDN). Then the 3GPP MTC-IWF acknowledges to the IN-CSE with the confirmation of receiving Device Triggering Request.

Step-4: Device Triggering delivery procedure

The MTC-IWF initiates the T4 trigger delivery procedure according to the 3GPP TS 23.682 [i.14], based on the information received from HSS and local policy.

NOTE 2: 3GPP Network Entities (e.g. SMS-SC) can select appropriate device triggering mechanism (e.g. SMS based or SIP based via IP-SM-GW) according to the device capabilities.

Step 5: ASN/MN-CSE receives the trigger

As a result of the triggering procedure, the payload is delivered to the ASN/MN-CSE trigger recipient.

NOTE 3: In case the Device Trigger contains the optional part of the trigger payload, it is assumed that such trigger payload e is forwarded to the application inside the ASN/MN-CSE that is started as a result of device trigger.

Step 6: Device Triggering report

Request:

The MTC-IWF sends the Device Trigger Report message (containing the M2M-Ext-ID or MSISDN and trigger reference number) to the IN-CSE with a cause value indicating whether the trigger delivery succeeded or failed and the reason for the failure.

Acknowledge:

IN-CSE acknowledges to the MTC-IWF with the conformation of the received Device Triggering Report.

Step 7 (Optional): Connection establishment procedure

The ASN/MN-CSE performs the Connection establishment procedure as described in clause B.6.1.1 and oneM2M TS-0003 [2] for Secure Connection establishment.

As a result of this procedure the initial request over the reference point Mcc can be executed.

Step 8 (Optional): CSE-PoA/Reachability state updated

Once the connection over Mcc is established, the PoA of the ASN/MN-CSE will be updated at the IN-CSE with the new established IP address and the IN-CSE holds the reachability state of the ASN/MN-CSE.

Step 9 (Optional): Re-sending of original request

As a result of step 7, the communication is established and now the initial request with the information stored in the buffer of the IN-CSE at Step 3 can be re-issued over the reference point Mcc.

Annex C (informative): Interworking between oneM2M System and 3GPP2 Underlying Networks

C.1 General Concepts

Interworking between oneM2M System and 3GPP2 Underlying Networks is based on 3GPP2 X.P0068 [i.17].

In order to provide M2M services, interworking between oneM2M System and the 3GPP2 Underlying Network is required. M2M Applications (AEs) in the M2M UEs (M2M Nodes such as the ASNs and MNs) and the M2M Applications in the external network (Infrastructure Domain) use services provided by the 3GPP2 Underlying Network, and optionally the services provided by an M2M Server (IN-CSE). The 3GPP2 Underlying Network provides transport and communication services, including 3GPP2 bearer services, IMS and SMS.

3GPP2 Underlying Network supports several interworking models, such as the following:

- Direct Model - Direct Communication provided by the 3GPP2 Network Operator:
 - The M2M Applications in the external network connect directly to the M2M Applications in the UEs used for M2M via the 3GPP2 Underlying Network without the use of any M2M Server.
- Indirect Model - M2M Service Provider controlled communication:
 - Uses an M2M Server that is an entity outside the 3GPP2 Underlying Network operator domain for enabling communications between the Applications in the external network and at the UEs used for M2M. Tsp interface or SMS interface is an external interface that the third party M2M Server supports with the entities that are within the 3GPP2 Underlying Network domain.
- Indirect Model - 3GPP2 Operator controlled communication:
 - Uses an M2M Server that is an entity inside the 3GPP2 Underlying Network operator domain for enabling communications between the Applications in the external network and at the UEs used for M2M. Tsp interface or SMS interface is an internal interface that the 3GPP2 Underlying Network operator controlled M2M Server supports with other entities within the 3GPP2 Underlying Network domain.
- Hybrid Model:
 - Direct and Indirect models are used simultaneously in the hybrid model i.e. performing Control Plane signalling using the Indirect Model and connecting the M2M Applications in the external network and at the UEs used for M2M over User Plane using the Direct Model.

C.2 M2M Communication Models

In the indirect and hybrid models, the deployment of an M2M Server (IN-CSE) may be inside or outside the 3GPP2 Underlying Network operator domain as illustrated in figures C.2-1 and C.2-2. When the M2M Server is part of the 3GPP2 Underlying Network operator domain (figures C.2-1(C) and C.2-2), the M2M Server is considered a 3GPP2 Underlying Network operator internal network function, is operator controlled, and may provide operator value-added services. In this case, security and privacy protection for communication between the M2M-IWF and the M2M Server (IN-CSE) is optional. When the M2M Server is deployed outside the 3GPP2 Underlying Network operator domain (figures C.2-1(B) and C.2-2), the M2M Server is M2M Service Provider controlled. In this case, security and privacy protection for communication between the M2M-IWF and the M2M Server (IN-CSE) is needed. In the direct model (figure C.2-1(A)), there is no external or internal M2M Server in the communication path.

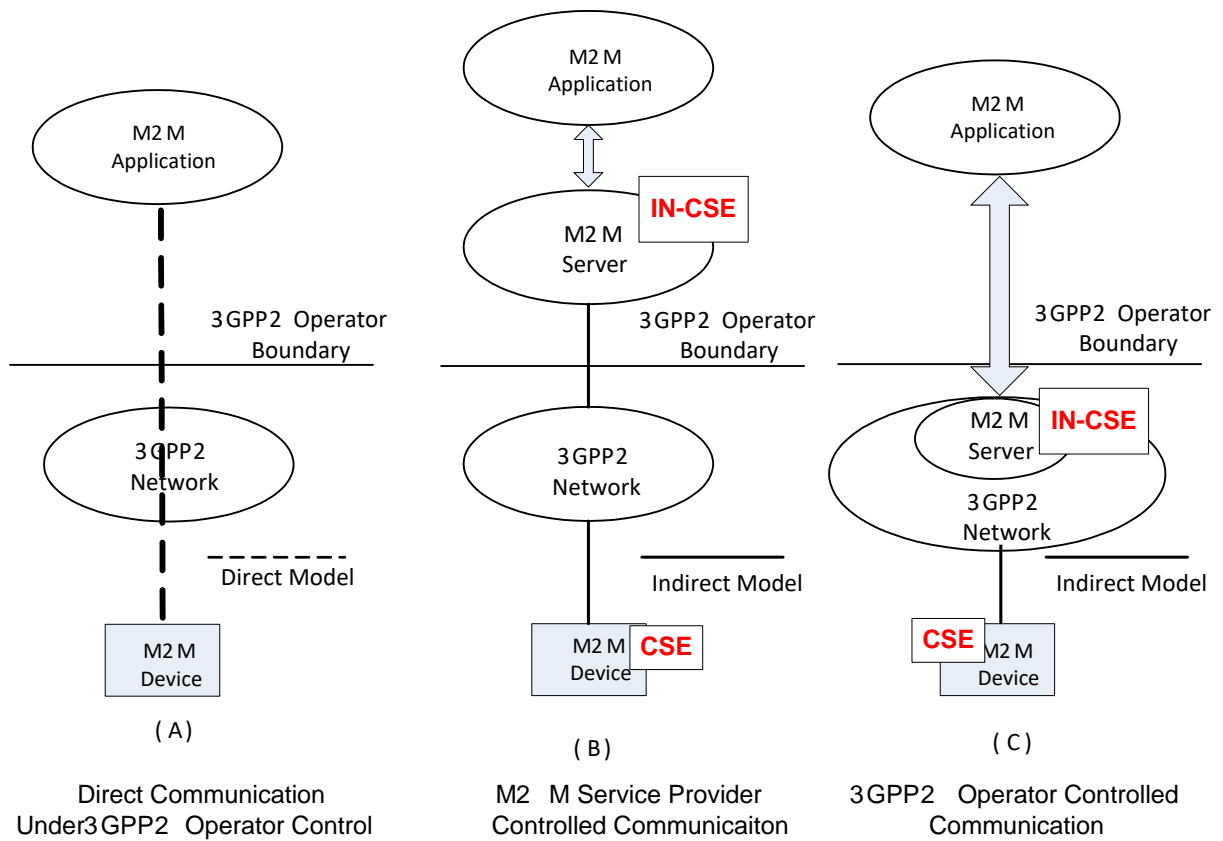

Figure C.2-1: M2M Communication Models

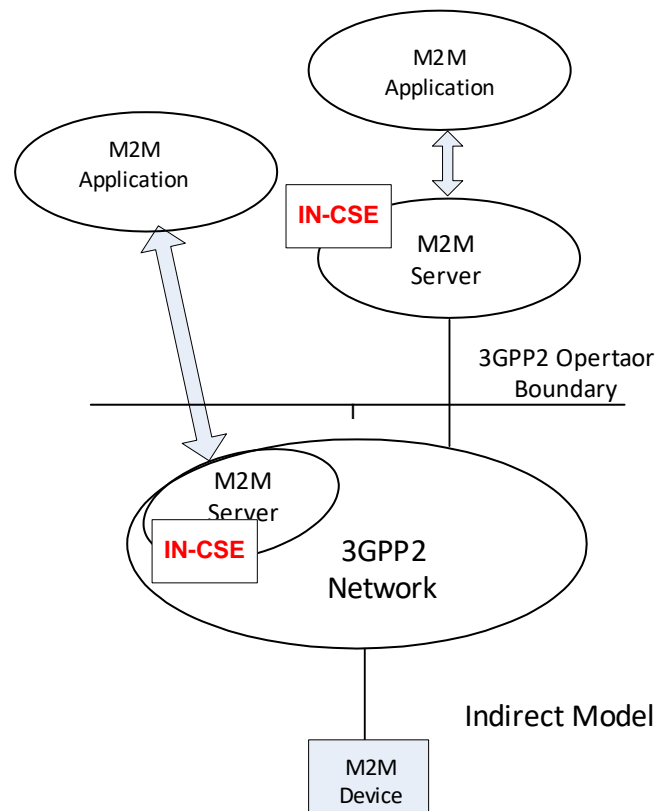

Figure C.2-2: Multiple M2M Applications Using Diverse Communication Models

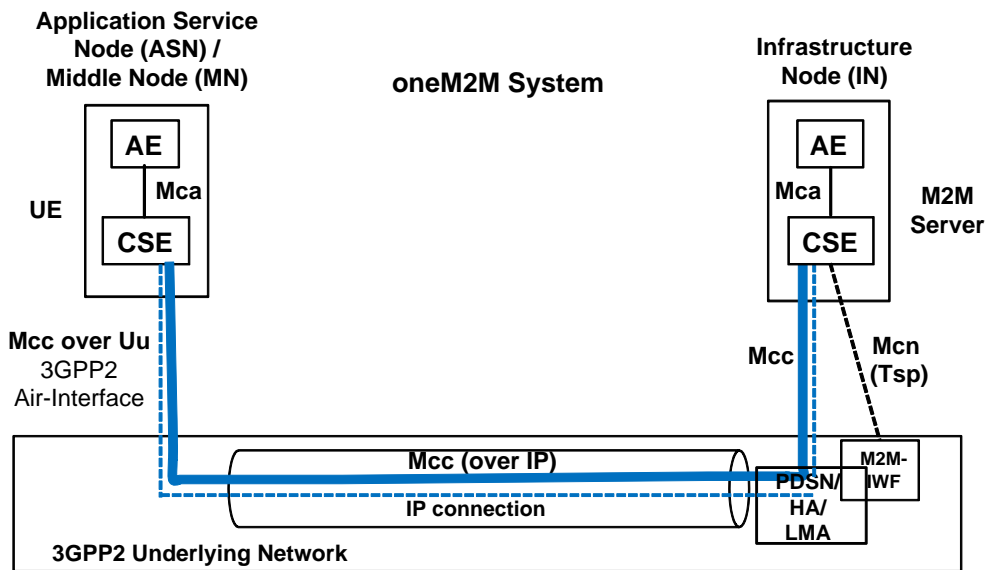

Figure C.4-1: User Plane and Control Plane Communication Paths

C.5 Information Flows

C.5.0 Overview

3GPP2 X.S0068 [i.17] specifies several system optimizations that can be used for M2M applications. Such optimizations include the following:

- Interaction of M2M Server with M2M-IWF for device triggering.
- Device trigger using SMS.
- Device trigger using broadcast SMS.
- Device trigger using IP transport.

C.5.1 Tsp Interface Call Flow

Figure C.5.1-1 is the high level call flow illustrating device triggering using Tsp interface.

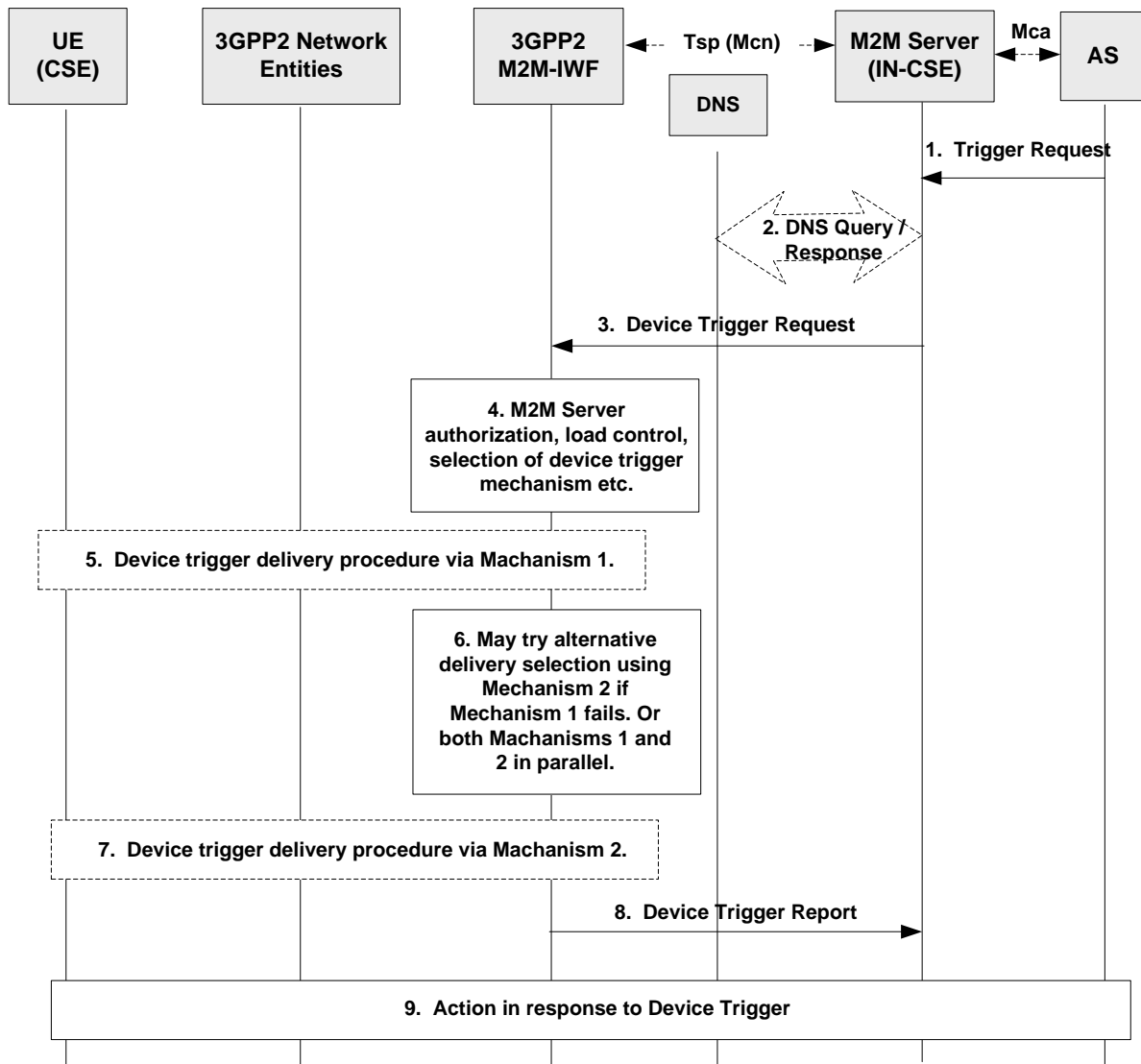

Figure C.5.1-1: Tsp Interface Call Flow

- 1) M2M Server (IN-CSE) receives a request from an M2M Application Server (AS in Infrastructure Domain) to deliver data to a UE used for M2M (ASN/MN-CSE) located in the 3GPP2 Underlying Network. Knowing the CSE-ID of the destination M2M Node, IN-CSE deduces its 3GPP2 External Identifier.
- 2) M2M Server (IN-CSE) may perform DNS query to obtain the IP address of the M2M-IWF for reaching the destination M2M Node.
- 3) M2M Server sends Device Trigger Request message to the M2M-IWF that includes destination M2M Node External ID and other information.
- 4) M2M-IWF checks that the M2M Server is authorized to send trigger requests and performs other tasks such as verifying that the M2M Server has not exceeded its quota or rate of trigger submission over Tsp. If such checks fail, the M2M-IWF sends a Device Trigger Confirm message with a cause value indicating the reason for the failure condition and the call flow stops at this step.

Otherwise, the M2M-IWF continues to interact with HAAA/HLR for obtaining 3GPP2 Internal ID for the M2M Node and other information for reaching the M2M Node in the 3GPP2 Underlying Network. M2M-IWF also determines the device trigger mechanisms (e.g. Mechanism 1, Mechanism 2 etc.) supported by the M2M Node. The flow continues with step 5.

- 5) M2M-IWF decides to deliver device trigger using e.g. Mechanism 1 and performs appropriate 3GPP2 Underlying Network specific procedures.
- 6) M2M-IWF may try alternative device trigger delivery mechanism (e.g. Mechanism 2) if Mechanism 1 fails. Or both Mechanism 1 and 2 can be performed in parallel.
- 7) M2M-IWF performs appropriate 3GPP2 Underlying Network specific procedures for delivering device trigger using Mechanism 2.
- 8) M2M-IWF sends Device Trigger Report to the M2M Server upon receiving the acknowledgment from the M2M Node that it has received M2M device trigger.
- 9) The M2M Node and the M2M Server/AS take actions in response to the device trigger as needed.

C.5.2 Point to Point Device Triggering

3GPP2 Underlying Network supports the following point-to-point device triggering mechanisms:

- SMS on common channel.
- SMS on 1xCS traffic channel.
- Device trigger using IP interface.

Device trigger using IP interface assumes that PPP sessions has been established and maintained between the M2M Node and the PDSN. An IP address has been assigned to the M2M Node by the IP anchor (PDSN/HA/LMA) and is maintained by the M2M Node and by other entities (e.g. HAAA) in the 3GPP2 Underlying Network. Upon receiving device trigger from the M2M Server, the M2M-IWF obtains the IP address assigned to the M2M Node from the M2M-AAA/HAAA. After that, the M2M-IWF sends device trigger to the M2M Node through IP routing via IP interface to the HA/LMA for MIP and PMIP operation, or to the PDSN for Simple IP operation.

C.5.3 Broadcast Device Triggering

3GPP2 Underlying Network supports the following broadcast device triggering mechanisms:

- SMS broadcast.

Annex D (normative): <mgmtObj> Resource Instances Description

D.1 oneM2M Management Functions

This clause describes the management functions supported by oneM2M. These functions are fulfilled by defining specializations of <mgmtObj> resources. These specializations can be regarded as "sub-types" of the <mgmtObj> resource type with specific designing to support different management capabilities through operations defined by oneM2M. These specializations are service layer information models for the purpose of management. They can be used within the M2M service layer or they can be further mapped to existing management technologies such as OMA DM [i.3], OMA LWM2M [i.4] and BBF TR-069 [i.2] to enable the management of devices with OMA or BBF compliant management clients.

NOTE: The resources defined in this Annex D represent specializations of the <mgmtObj> resource as a result of introducing specializations of the [objectAttribute] attribute. The *mgmtDefinition* attribute carries the name of the resource type specialization. The names of instantiations of these resource specializations are not fixed.

D.2 Resource *firmware*

The [firmware] resource is used to share information regarding the firmware on the device. The [firmware] resource is a specialization of the <mgmtObj> resource.

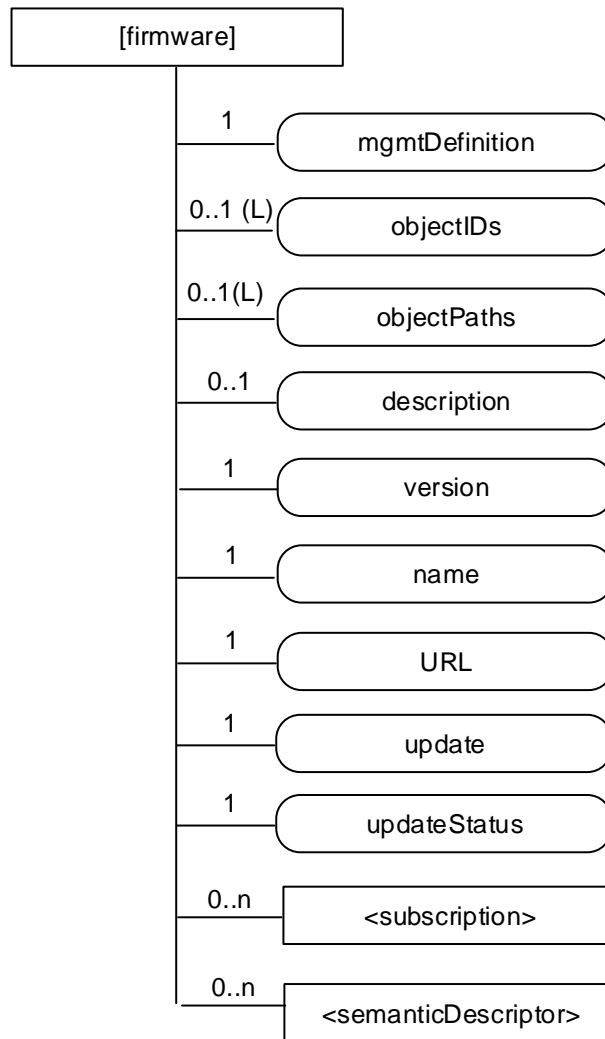

Figure D.2-1: Structure of [firmware] resource

The [firmware] resource shall contain the child resources specified in table D.2-1.

Table D.2-1: Child resources of [firmware] resource

Child Resources of [firmware]	Child Resource Type	Multiplicity	Description
[variable]	<subscription>	0..n	See clause 9.6.8 where the type of this resource is described
[variable]	<semanticDescriptor>	0..n	See clause 9.6.30

The *[firmware]* resource shall contain the attributes specified in table D.2-2.

Table D.2-2: Attributes of *[firmware]* resource

Attributes of <i>[firmware]</i>	Multiplicity	RW/ RO/ WO	Description
<i>resourceType</i>	1	RO	See clause 9.6.1.3.
<i>resourceID</i>	1	RO	See clause 9.6.1.3.
<i>resourceName</i>	1	WO	See clause 9.6.1.3.
<i>parentID</i>	1	RO	See clause 9.6.1.3.
<i>expirationTime</i>	1	RW	See clause 9.6.1.3.
<i>accessControlPolicyIDs</i>	0..1 (L)	RW	See clause 9.6.1.3.
<i>creationTime</i>	1	RO	See clause 9.6.1.3.
<i>lastModifiedTime</i>	1	RO	See clause 9.6.1.3.
<i>labels</i>	0..1(L)	RW	See clause 9.6.1.3.
<i>mgmtDefinition</i>	1	WO	See clause 9.6.15. Has fixed value "firmware" to indicate the resource is for firmware management.
<i>objectIDs</i>	0..1 (L)	WO	See clause 9.6.15.
<i>objectPaths</i>	0..1 (L)	WO	See clause 9.6.15.
<i>description</i>	0..1	RW	See clause 9.6.15.
<i>version</i>	1	RW	The version of the firmware. This attribute is a specialization of <i>[objectAttribute]</i> attribute.
<i>name</i>	1	RW	The name of the firmware to be used on the device. This attribute is a specialization of <i>[objectAttribute]</i> attribute.
<i>URL</i>	1	RW	The URL from which the firmware image can be downloaded. This attribute is a specialization of <i>[objectAttribute]</i> attribute.
<i>update</i>	1	RW	The action that downloads and installs a new firmware in a single operation. The action is triggered by assigning value "TRUE" to this attribute. This attribute is a specialization of <i>[objectAttribute]</i> attribute.
<i>updateStatus</i>	1	RW	Indicates the status of the update. This attribute is a specialization of <i>[objectAttribute]</i> attribute.

D.3 Resource software

The *[software]* resource is used to share information regarding the software on the device. The *[software]* resource is a specialization of the *<mgmtObj>* resource.

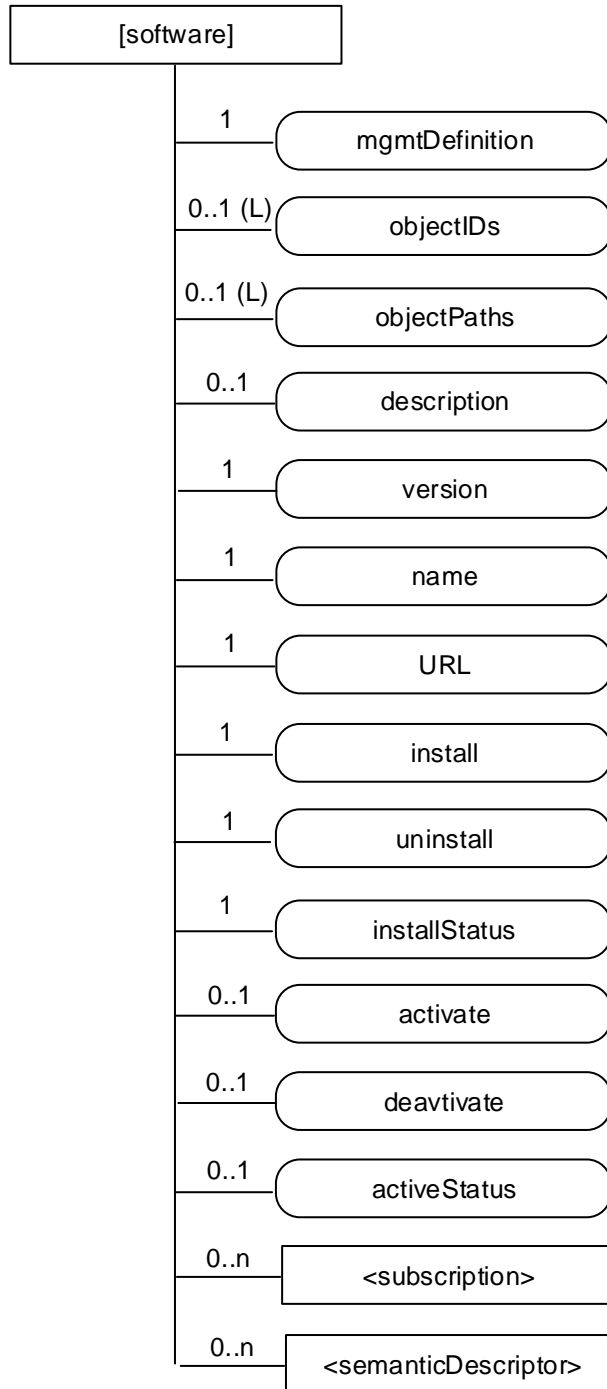

Figure D.3-1: Structure of [software] resource

The [software] resource shall contain the child resource specified in table D.3-1.

Table D.3-1: Child resources of [software] resource

Child Resources of [software]	Child Resource Type	Multiplicity	Description
[variable]	<subscription>	0..n	See clause 9.6.8 where the type of this resource is described
[variable]	<semanticDescriptor>	0..n	See clause 9.6.30

The *[software]* resource shall contain the attributes specified in table D.3-2.

Table D.3-2: Attributes of *[software]* resource

Attributes of <i>[software]</i>	Multiplicity	RW/RO/WO	Description
<i>resourceType</i>	1	RO	See clause 9.6.1.3.
<i>resourceID</i>	1	RO	See clause 9.6.1.3.
<i>resourceName</i>	1	WO	See clause 9.6.1.3.
<i>parentID</i>	1	RO	See clause 9.6.1.3.
<i>expirationTime</i>	1	RW	See clause 9.6.1.3.
<i>accessControlPolicyIDs</i>	0..1 (L)	RW	See clause 9.6.1.3.
<i>creationTime</i>	1	RO	See clause 9.6.1.3.
<i>lastModifiedTime</i>	1	RO	See clause 9.6.1.3.
<i>labels</i>	0..1(L)	RW	See clause 9.6.1.3.
<i>mgmtDefinition</i>	1	WO	See clause 9.6.15. Has fixed value "software" to indicate the resource is for software management.
<i>objectIDs</i>	0..1 (L)	WO	See clause 9.6.15.
<i>objectPaths</i>	0..1 (L)	WO	See clause 9.6.15.
<i>description</i>	0..1	RW	See clause 9.6.15.
<i>version</i>	1	RW	The version of the software. This attribute is a specialization of <i>[objectAttribute]</i> attribute.
<i>name</i>	1	RW	The name of the software to be used on the device. This attribute is a specialization of <i>[objectAttribute]</i> attribute.
<i>URL</i>	1	RW	The URL from which the software package can be downloaded. This attribute is a specialization of <i>[objectAttribute]</i> attribute.
<i>install</i>	1	RW	The action that downloads and installs new software in a single operation. The action is triggered by assigning value "TRUE" to this attribute. This attribute is a specialization of <i>[objectAttribute]</i> attribute.
<i>uninstall</i>	1	RW	The action that un-installs the software. The action is triggered by assigning value "TRUE" to this attribute. This attribute is a specialization of <i>[objectAttribute]</i> attribute.
<i>installStatus</i>	1	RW	Indicates the status of the install. This attribute is a specialization of <i>[objectAttribute]</i> attribute.
<i>activate</i>	0..1	RW	The action that activates software previously installed. The action is triggered by assigning value "TRUE" to this attribute. This attribute is a specialization of <i>[objectAttribute]</i> attribute.
<i>deactivate</i>	0..1	RW	The action that deactivates software. The action is triggered by assigning value "TRUE" to this attribute. This attribute is a specialization of <i>[objectAttribute]</i> attribute.
<i>activeStatus</i>	0..1	RW	The status of active or deactivate action. This attribute is a specialization of <i>[objectAttribute]</i> attribute.

The state machine for managing the software in oneM2M is shown in figure D.3-2.

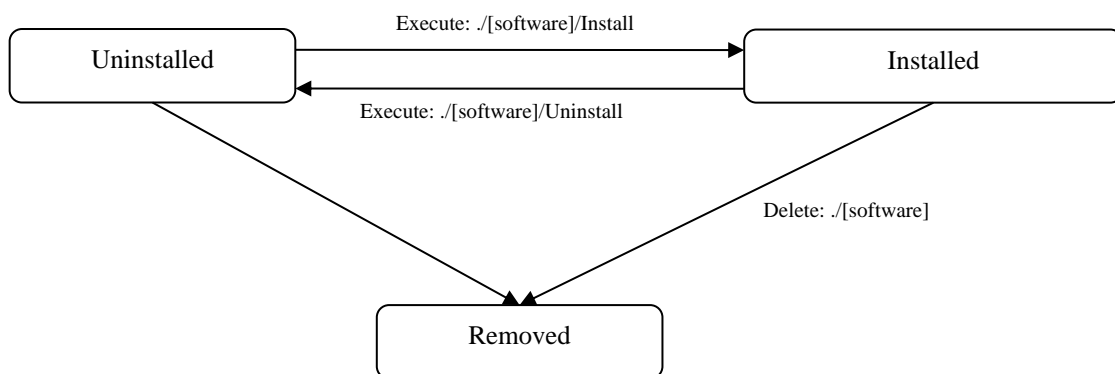

Figure D.3-2: State machine for *[software]* management

Figure D.3-3 is the state machine after install starts from the deactivated state.

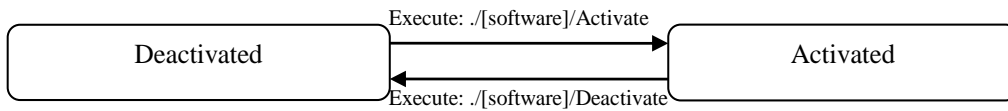

Figure D.3-3: State machine for [software] management after install

D.4 Resource *memory*

The [memory] resource is used to share information regarding the memory on the device. The [memory] resource is a specialization of the <mgmtObj>resource.

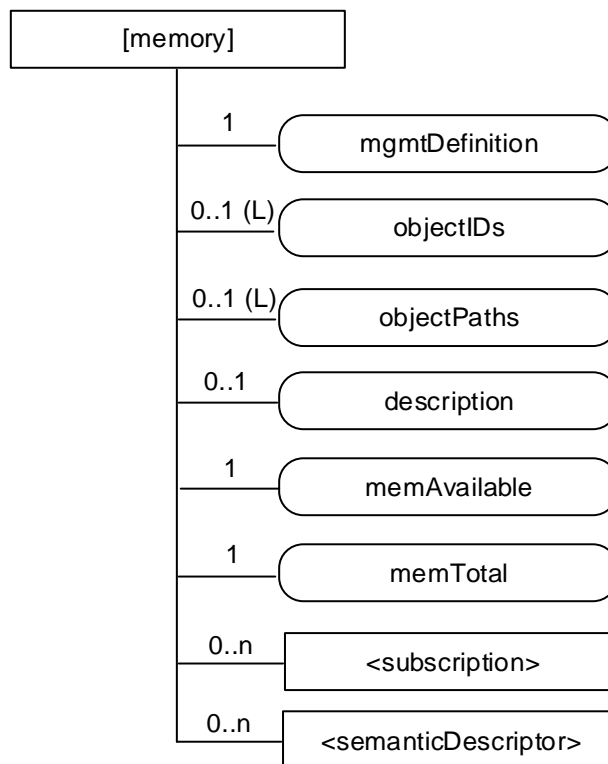

Figure D.4-1: Structure of [memory] resource

The [memory] resource shall contain the child resources specified in table D.4-1.

Table D.4-1: Child resources of [memory] resource

Child Resources of [memory]	Child Resource Type	Multiplicity	Description
[variable]	<subscription>	0..n	See clause 9.6.8 where the type of this resource is described
[variable]	<semanticDescriptor>	0..n	See clause 9.6.30

The *[memory]* resource shall contain the attributes specified in table D.4-2.

Table D.4-2: Attributes of *[memory]* resource

Attributes of <i>[memory]</i>	Multiplicity	RW/RO/WO	Description
<i>resourceType</i>	1	RO	See clause 9.6.1.3.
<i>resourceID</i>	1	RO	See clause 9.6.1.3.
<i>resourceName</i>	1	WO	See clause 9.6.1.3.
<i>parentID</i>	1	RO	See clause 9.6.1.3.
<i>expirationTime</i>	1	RW	See clause 9.6.1.3.
<i>accessControlPolicyIDs</i>	0..1 (L)	RW	See clause 9.6.1.3.
<i>creationTime</i>	1	RO	See clause 9.6.1.3.
<i>lastModifiedTime</i>	1	RO	See clause 9.6.1.3.
<i>labels</i>	0..1(L)	RW	See clause 9.6.1.3.
<i>mgmtDefinition</i>	1	WO	See clause 9.6.15. Has fixed value "memory" to indicate the resource is for memory management.
<i>objectIDs</i>	0..1 (L)	WO	See clause 9.6.15.
<i>objectPaths</i>	0..1 (L)	WO	See clause 9.6.15.
<i>description</i>	0..1	RW	See clause 9.6.15.
<i>memAvailable</i>	1	RW	The current available amount of memory. This attribute is a specialization of <i>[objectAttribute]</i> attribute.
<i>memTotal</i>	1	RW	The total amount of memory. This attribute is a specialization of <i>[objectAttribute]</i> attribute.

D.5 Resource *areaNwkInfo*

The *[areaNwkInfo]* resource is a specialization of the *<mgmtObj>* resource.

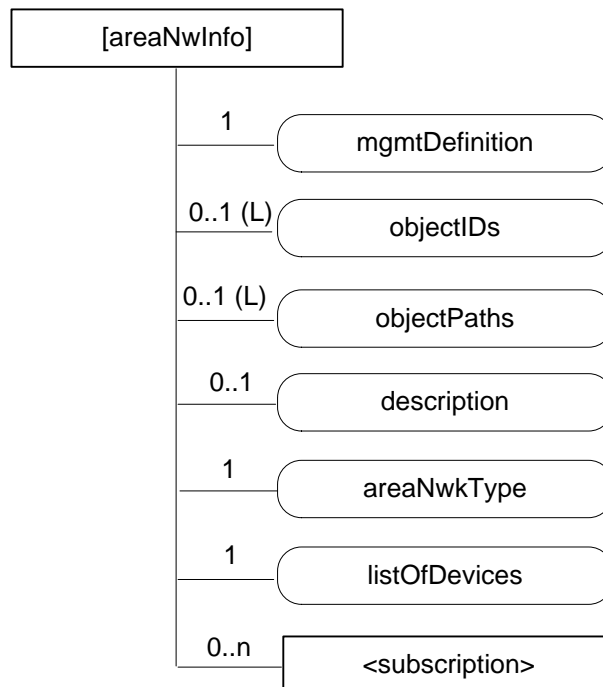

Figure D.5-1: Structure of *[areaNwkInfo]* resource

The *[areaNwkInfo]* resource shall contain the child resource specified in table D.5-1.

Table D.5-1: Child resources of *[areaNwkInfo]* resource

Child Resources of <i>[areaNwkInfo]</i>	Child Resource Type	Multiplicity	Description
<i>[variable]</i>	< <i>subscription</i> >	0..n	See clause 9.6.8 where the type of this resource is described
<i>[variable]</i>	< <i>semanticDescriptor</i> >	0..n	See clause 9.6.30

The *[areaNwkInfo]* resource shall contain the attributes specified in table D.5-2.

Table D.5-2: Attributes of *[areaNwkInfo]* resource

Attributes of <i>[areaNwkInfo]</i>	Multiplicity	RW/RO/WO	Description
<i>resourceType</i>	1	RO	See clause 9.6.1.3.
<i>resourceID</i>	1	RO	See clause 9.6.1.3.
<i>resourceName</i>	1	WO	See clause 9.6.1.3.
<i>parentID</i>	1	RO	See clause 9.6.1.3.
<i>expirationTime</i>	1	RW	See clause 9.6.1.3.
<i>accessControlPolicyIDs</i>	0..1 (L)	RW	See clause 9.6.1.3.
<i>creationTime</i>	1	RO	See clause 9.6.1.3.
<i>lastModifiedTime</i>	1	RO	See clause 9.6.1.3.
<i>labels</i>	0..1(L)	RW	See clause 9.6.1.3.
<i>mgmtDefinition</i>	1	WO	See clause 9.6.15. Has fixed value " <i>areaNwkInfo</i> " to indicate the resource is for area network information.
<i>objectIDs</i>	0..1 (L)	WO	See clause 9.6.15.
<i>objectPaths</i>	0..1 (L)	WO	See clause 9.6.15.
<i>description</i>	0..1	RW	See clause 9.6.15.
<i>areaNwkType</i>	1	RW	The <i>areaNwkType</i> is an implementation-chosen string that indicates the type of M2M Area Network. This attribute is a specialization of <i>[objectAttribute]</i> attribute.
<i>listOfDevices</i>	1	RW	Indicates the list of devices in the M2M Area Network. The attribute contains references to <i>[areaNwkDeviceInfo]</i> resource. From <i>listOfDevices</i> , the topology of the area network can be discovered and retrieved. This attribute is a specialization of <i>[objectAttribute]</i> attribute.

D.6 Resource areaNwkDeviceInfo

The *[areaNwkDeviceInfo]* resource is a specialization of the *<mgmtObj>* resource.

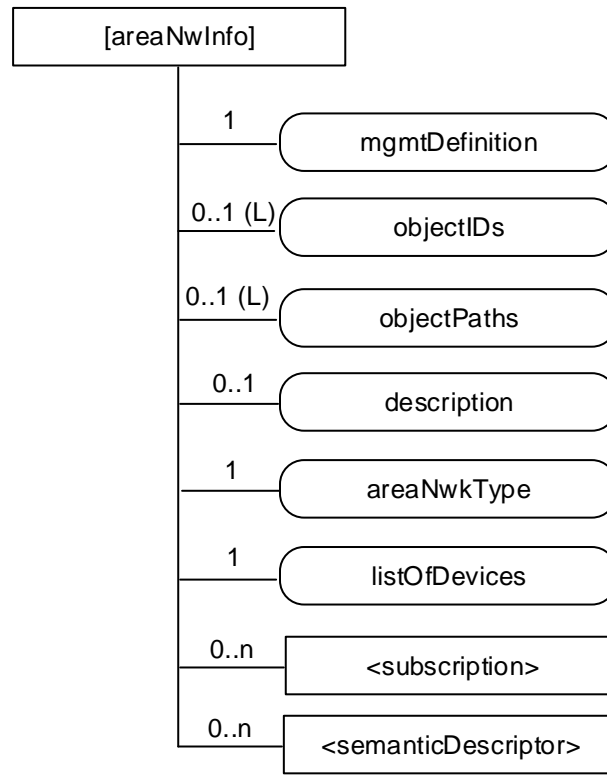

Figure D.6-1: Structure of *[areaNwkDeviceInfo]* resource

The *[areaNwkDeviceInfo]* resource shall contain the child resources specified in table D.6-1.

Table D.6-1: Child resources of *[areaNwkDeviceInfo]* resource

Child Resources of <i>[areaNwkDeviceInfo]</i>	Child Resource Type	Multiplicity	Description
<i>[variable]</i>	<i><subscription></i>	0..n	See clause 9.6.8 where the type of this resource is described
<i>[variable]</i>	<i><semanticDescriptor></i>	0..n	See clause 9.6.30

The *[areaNwkDeviceInfo]* resource shall contain the attributes specified in table D.6-2.

Table D.6-2: Attributes of *[areaNwkDeviceInfo]* resource

Attributes of [areaNwkDeviceInfo]	Multiplicity	RW/RO/WO	Description
resourceType	1	RO	See clause 9.6.1.3.
resourceID	1	RO	See clause 9.6.1.3.
resourceName	1	WO	See clause 9.6.1.3.
parentID	1	RO	See clause 9.6.1.3.
expirationTime	1	RW	See clause 9.6.1.3.
accessControlPolicyIDs	0..1 (L)	RW	See clause 9.6.1.3.
creationTime	1	RO	See clause 9.6.1.3.
lastModifiedTime	1	RO	See clause 9.6.1.3.
labels	0..1(L)	RW	See clause 9.6.1.3.
mgmtDefinition	1	WO	See clause 9.6.15. Has fixed value "areaNwkDeviceInfo" to indicate the resource is for area network device information.
objectIDs	0..1 (L)	WO	See clause 9.6.15.
objectPaths	0..1 (L)	WO	See clause 9.6.15.
description	0..1	RW	See clause 9.6.15.
devId	1	RW	Indicates the id of the device. It could be the id of the hardware or <i>nodeId</i> . This attribute is a specialization of [objectAttribute] attribute.
devType	1	RW	Indicates the type of the device. The attribute also indicates the functions or services that are provided by the device. Examples include temperature sensor, actuator, Zigbee coordinator or Zigbee router. This attribute is a specialization of [objectAttribute] attribute.
areaNwkId	1	RW	The reference to an <i>areaNwkInfo</i> resource which this device associates with. This attribute is a specialization of [objectAttribute] attribute.
sleepInterval	0..1	RW	The interval between two sleeps. This attribute is a specialization of [objectAttribute] attribute.
sleepDuration	0..1	RW	The time duration of each sleep. This attribute is a specialization of [objectAttribute] attribute.
status	0..1	RW	The status of the device (sleeping or waked up).
listOfNeighbors	1	RW	Indicates the neighbour devices of the same area network. When modified, the connection relationship of the devices shall be modified accordingly. This attribute is a specialization of [objectAttribute] attribute.

D.7 Resource *battery*

The *[battery]* resource is used to share information regarding the battery. The *[battery]* resource is a specialization of the *<mgmtObj>* resource.

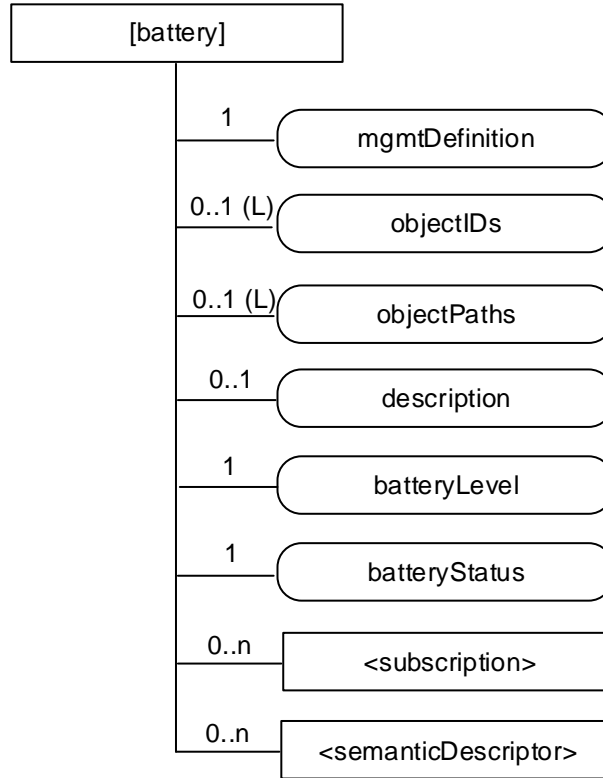

Figure D.7-1: Structure of *[battery]* resource

The *[battery]* resource shall contain the child resources specified in table D.7-1.

Table D.7-1: Child resources of *[battery]* resource

Child Resources of <i>[battery]</i>	Child Resource Type	Multiplicity	Description
<i>[variable]</i>	<i><subscription></i>	0..n	See clause 9.6.8 where the type of this resource is described
<i>[variable]</i>	<i><semanticDescriptor></i>	0..n	See clause 9.6.30

The *[battery]* resource shall contain the attributes specified in table D.7-2.

Table D.7-2: Attributes of *[battery]* resource

Attributes of <i>[battery]</i>	Multiplicity	RW/ RO/ WO	Description
<i>resourceType</i>	1	RO	See clause 9.6.1.3.
<i>resourceID</i>	1	RO	See clause 9.6.1.3.
<i>resourceName</i>	1	WO	See clause 9.6.1.3.
<i>parentID</i>	1	RO	See clause 9.6.1.3.
<i>expirationTime</i>	1	RW	See clause 9.6.1.3.
<i>accessControlPolicyIDs</i>	0..1 (L)	RW	See clause 9.6.1.3.
<i>creationTime</i>	1	RO	See clause 9.6.1.3.
<i>lastModifiedTime</i>	1	RO	See clause 9.6.1.3.
<i>labels</i>	0..1(L)	RW	See clause 9.6.1.3.
<i>mgmtDefinition</i>	1	WO	See clause 9.6.15. This attribute shall have the fixed value " <i>battery</i> ".
<i>objectIDs</i>	0..1 (L)	WO	See clause 9.6.15.
<i>objectPaths</i>	0..1 (L)	WO	See clause 9.6.15.
<i>description</i>	0..1	RW	See clause 9.6.15.
<i>batteryLevel</i>	1	RW	The current battery level. This attribute is a specialization of <i>[objectAttribute]</i> attribute.
<i>batteryStatus</i>	1	RW	Indicates the status of the battery. This attribute is a specialization of <i>[objectAttribute]</i> attribute.

D.8 Resource *deviceInfo*

The *[deviceInfo]* resource is used to share information regarding the device. The *[deviceInfo]* resource is a specialization of the *<mgmtObj>* resource.

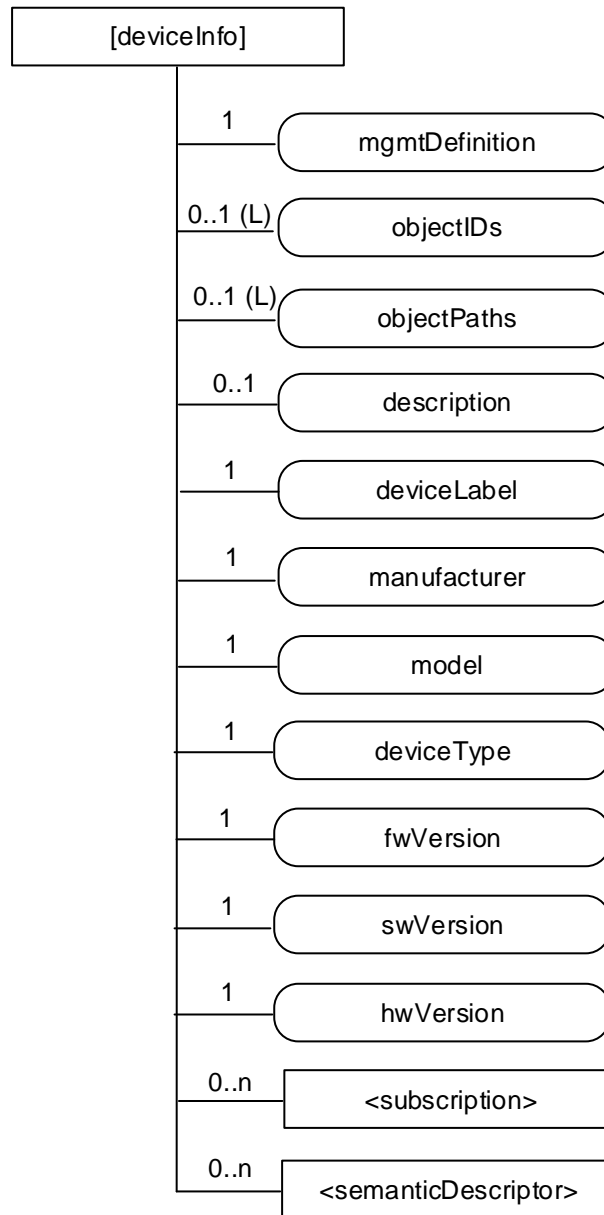

Figure D.8-1: Structure of *[deviceInfo]* resource

The *[deviceInfo]* resource shall contain the child resources specified in table D.8-1.

Table D.8-1: Child resources of *[deviceInfo]* resource

Child Resources of <i>[deviceInfo]</i>	Child Resource Type	Multiplicity	Description
<i>[variable]</i>	<i><subscription></i>	0..n	See clause 9.6.8 where the type of this resource is described
<i>[variable]</i>	<i><semanticDescriptor></i>	0..n	See clause 9.6.30

The *[deviceInfo]* resource shall contain the attributes specified in table D.8-2.

Table D.8-2: Attributes of *[deviceInfo]* resource

Attributes of <i>[deviceInfo]</i>	Multiplicity	RW/ RO/ WO	Description
<i>resourceType</i>	1	RO	See clause 9.6.1.3.
<i>resourceID</i>	1	RO	See clause 9.6.1.3.
<i>resourceName</i>	1	WO	See clause 9.6.1.3.
<i>parentID</i>	1	RO	See clause 9.6.1.3.
<i>expirationTime</i>	1	RW	See clause 9.6.1.3.
<i>accessControlPolicyIDs</i>	0..1 (L)	RW	See clause 9.6.1.3.
<i>creationTime</i>	1	RO	See clause 9.6.1.3.
<i>lastModifiedTime</i>	1	RO	See clause 9.6.1.3.
<i>labels</i>	0..1(L)	RW	See clause 9.6.1.3.
<i>mgmtDefinition</i>	1	WO	See clause 9.6.15. This attribute shall have the fixed value " <i>deviceInfo</i> ".
<i>objectIDs</i>	0..1 (L)	WO	See clause 9.6.15.
<i>objectPaths</i>	0..1 (L)	WO	See clause 9.6.15.
<i>description</i>	0..1	RW	See clause 9.6.15.
<i>deviceLabel</i>	1	RO	Unique device label assigned by the manufacturer. The uniqueness may be global or only valid within a certain domain (e.g. vendor-wise or for a certain <i>deviceType</i>). This attribute is a specialization of <i>[objectAttribute]</i> attribute.
<i>manufacturer</i>	1	RO	The name/identifier of the device manufacturer. This attribute is a specialization of <i>[objectAttribute]</i> attribute.
<i>model</i>	1	RO	The name/identifier of the device mode assigned by the manufacturer. This attribute is a specialization of <i>[objectAttribute]</i> attribute.
<i>deviceType</i>	1	RO	The type (e.g. cell phone, photo frame, smart meter) or product class (e.g. X-series) of the device. This attribute is a specialization of <i>[objectAttribute]</i> attribute.
<i>fwVersion</i>	1	RO	The firmware version of the device (see note).
<i>swVersion</i>	1	RO	The software version of the device. This attribute is a specialization of <i>[objectAttribute]</i> attribute.
<i>hwVersion</i>	1	RO	The hardware version of the device. This attribute is a specialization of <i>[objectAttribute]</i> attribute.
NOTE:	If the device only supports one kind of Software this is identical to <i>swVersion</i> . This attribute is a specialization of <i>[objectAttribute]</i> attribute.		

D.9 Resource deviceCapability

The *[deviceCapability]* resource represents each device's capability. The *[deviceCapability]* resource is a specialization of the *<mgmtObj>* resource.

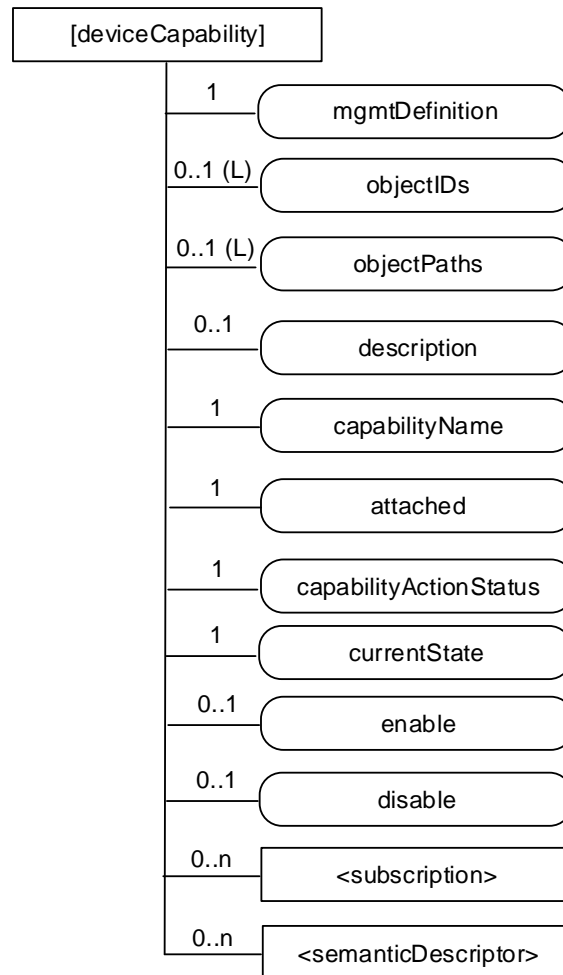

Figure D.9-1: Structure of *[deviceCapability]* resource

The *[deviceCapability]* resource shall contain the child resources specified in table D.9-1.

Table D.9-1: Child resources of *[deviceCapability]* resource

Child Resources of <i>[deviceCapability]</i>	Child Resource Type	Multiplicity	Description
<i>[variable]</i>	<i><subscription></i>	0..n	See clause 9.6.8 where the type of this resource is described
<i>[variable]</i>	<i><semanticDescriptor></i>	0..n	See clause 9.6.30

The *[deviceCapability]* resource shall contain the attributes specified in table D.9-2.

Table D.9-2: Attributes of *[deviceCapability]* resource

Attributes of <i>[deviceCapability]</i>	Multiplicity	RW/ RO/ WO	Description
<i>resourceType</i>	1	RO	See clause 9.6.1.3.
<i>resourceID</i>	1	RO	See clause 9.6.1.3.
<i>resourceName</i>	1	WO	See clause 9.6.1.3.
<i>parentID</i>	1	RO	See clause 9.6.1.3.
<i>expirationTime</i>	1	RW	See clause 9.6.1.3.
<i>accessControlPolicyIDs</i>	0..1 (L)	RW	See clause 9.6.1.3.
<i>creationTime</i>	1	RO	See clause 9.6.1.3.
<i>lastModifiedTime</i>	1	RO	See clause 9.6.1.3.
<i>labels</i>	0..1(L)	RW	See clause 9.6.1.3.
<i>mgmtDefinition</i>	1	WO	See clause 9.6.15. This attribute shall have the fixed value " <i>deviceCapability</i> ".
<i>objectIDs</i>	0..1 (L)	WO	See clause 9.6.15.
<i>objectPaths</i>	0..1 (L)	WO	See clause 9.6.15.
<i>description</i>	0..1	RW	See clause 9.6.15.
<i>capabilityName</i>	1	WO	The name of the capability. This attribute is a specialization of <i>[objectAttribute]</i> attribute.
<i>attached</i>	1	RO	Indicates whether the capability is attached to the device or not. This attribute is a specialization of <i>[objectAttribute]</i> attribute.
<i>capabilityActionStatus</i>	1	RO	Indicates the status of the Action (including a performed action and the corresponding final state). This attribute is a specialization of <i>[objectAttribute]</i> attribute.
<i>currentState</i>	1	RO	Indicates the current state of the capability (e.g. enabled or disabled). This attribute is a specialization of <i>[objectAttribute]</i> attribute.
<i>enable</i>	0..1	WO	The action that allows enabling the device capability. This attribute is a specialization of <i>[objectAttribute]</i> attribute.
<i>disable</i>	0..1	WO	The action that allows disabling the device capability. This attribute is a specialization of <i>[objectAttribute]</i> attribute.

D.10 Resource *reboot*

The *[reboot]* resource is used to reboot a device. The *[reboot]* resource is a specialization of the *<mgmtObj>* resource.

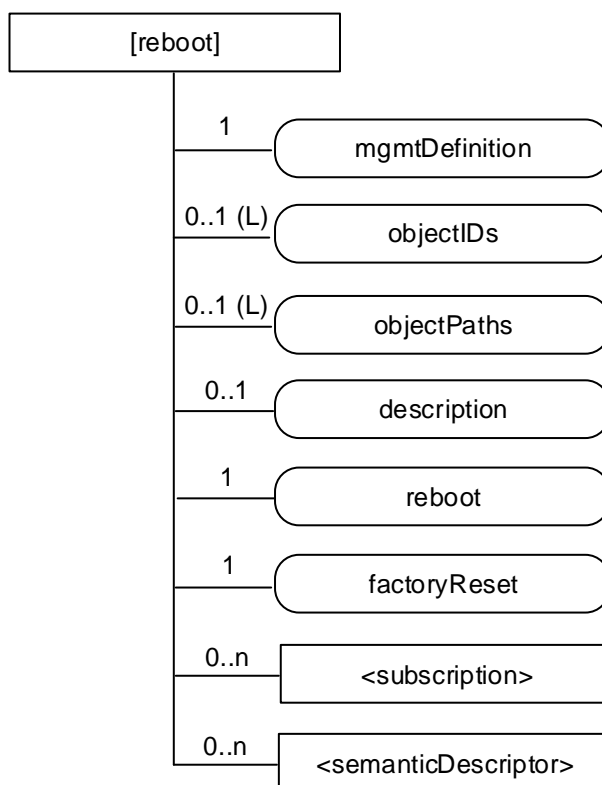

Figure D.10-1: Structure of *[reboot]* resource

The *[reboot]* resource shall contain the child resources specified in table D.10-1.

Table D.10-1: Child resources of *[reboot]* resource

Child Resources of <i>[reboot]</i>	Child Resource Type	Multiplicity	Description
<i>[variable]</i>	<i><subscription></i>	0..n	See clause 9.6.8 where the type of this resource is described
<i>[variable]</i>	<i><semanticDescriptor></i>	0..n	See clause 9.6.30

The *[reboot]* resource shall contain the attributes specified in table D.10-2.

Table D.10-2: Attributes of *[reboot]* resource

Attributes of <i>[reboot]</i>	Multiplicity	RW/ RO/ WO	Description
<i>resourceType</i>	1	RO	See clause 9.6.1.3.
<i>resourceID</i>	1	RO	See clause 9.6.1.3.
<i>resourceName</i>	1	WO	See clause 9.6.1.3.
<i>parentID</i>	1	RO	See clause 9.6.1.3.
<i>expirationTime</i>	1	RW	See clause 9.6.1.3.
<i>accessControlPolicyIDs</i>	0..1 (L)	RW	See clause 9.6.1.3.
<i>creationTime</i>	1	RO	See clause 9.6.1.3.
<i>lastModifiedTime</i>	1	RO	See clause 9.6.1.3.
<i>labels</i>	0..1(L)	RW	See clause 9.6.1.3.
<i>mgmtDefinition</i>	1	WO	See clause 9.6.15. This attribute shall have the fixed value "reboot".
<i>objectIDs</i>	0..1 (L)	WO	See clause 9.6.15.
<i>objectPaths</i>	0..1 (L)	WO	See clause 9.6.15.
<i>description</i>	0..1	RW	See clause 9.6.15.
<i>reboot</i>	1	RW	The action that allows rebooting the device. The action is triggered by assigning value "TRUE" to this attribute. This attribute is a specialization of <i>[objectAttribute]</i> attribute.
<i>factoryReset</i>	1	RW	The action that allows making the device returning to the factory settings. The action is triggered by assigning value "TRUE" to this attribute. This attribute is a specialization of <i>[objectAttribute]</i> attribute.

D.11 Resource *eventLog*

The *[eventLog]* resource is used to record the event log for a device. The *[eventLog]* resource is a specialization of the *<mgmtObj>* resource.

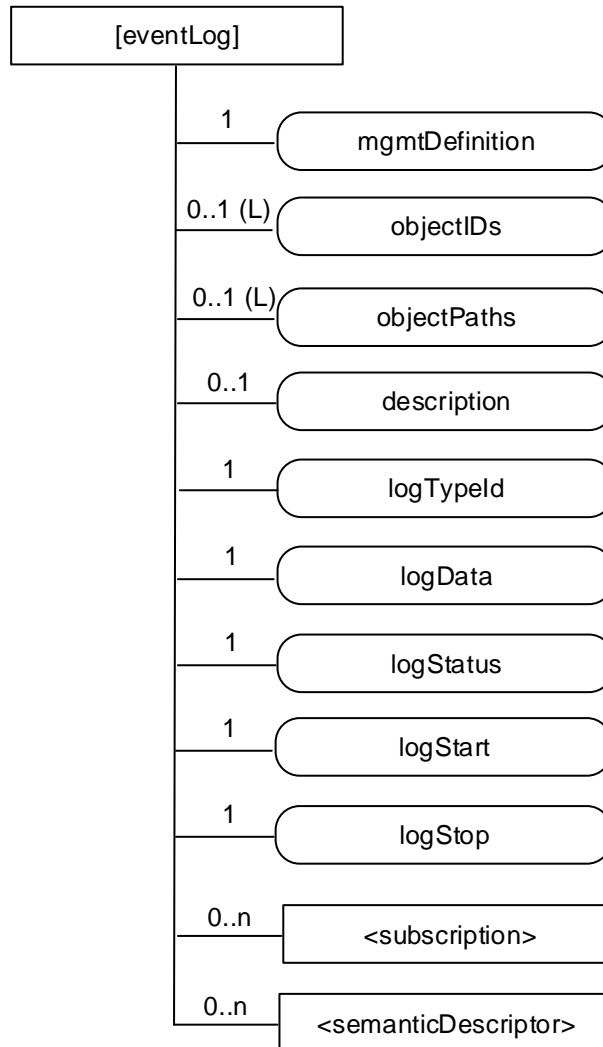

Figure D.11-1: Structure of *[eventLog]* resource

The *[eventLog]* resource shall contain the child resources specified in table D.11-1.

Table D.11-1: Child resources of *[eventLog]* resource

Child Resources of <i>[eventLog]</i>	Child Resource Type	Multiplicity	Description
<i>[variable]</i>	<i><subscription></i>	0..n	See clause 9.6.8 where the type of this resource is described
<i>[variable]</i>	<i><semanticDescriptor></i>	0..n	See clause 9.6.30

The *[eventLog]* resource shall contain the attributes specified in table D.11-2.

Table D.11-2: Attributes of *[eventLog]* resource

Attributes of <i>[eventLog]</i>	Multiplicity	RW/RO/WO	Description
<i>resourceType</i>	1	RO	See clause 9.6.1.3.
<i>resourceID</i>	1	RO	See clause 9.6.1.3.
<i>resourceName</i>	1	WO	See clause 9.6.1.3.
<i>parentID</i>	1	RO	See clause 9.6.1.3.
<i>expirationTime</i>	1	RW	See clause 9.6.1.3.
<i>accessControlPolicyIDs</i>	0..1 (L)	RW	See clause 9.6.1.3.
<i>creationTime</i>	1	RO	See clause 9.6.1.3.
<i>lastModifiedTime</i>	1	RO	See clause 9.6.1.3.
<i>labels</i>	0..1(L)	RW	See clause 9.6.1.3.
<i>mgmtDefinition</i>	1	WO	See clause 9.6.15. This attribute shall have the fixed value "eventLog".
<i>objectIDs</i>	0..1 (L)	WO	See clause 9.6.15.
<i>objectPaths</i>	0..1 (L)	WO	See clause 9.6.15.
<i>description</i>	0..1	RW	See clause 9.6.15.
<i>logTypeID</i>	1	RW	Identifies the types of log to be recorded. E.g. security log, system log. This attribute is a specialization of <i>[objectAttribute]</i> attribute.
<i>logData</i>	1	RW	Diagnostic data logged upon event of interests defined by this diagnostic function. This attribute is a specialization of <i>[objectAttribute]</i> attribute.
<i>logStatus</i>	1	RW	Indicates the status of the logging process. E.g. Started, Stopped. This attribute is a specialization of <i>[objectAttribute]</i> attribute.
<i>logStart</i>	1	RW	The action that allows starting the log corresponding to the mentioned <i>logTypeID</i> . The action is triggered by assigning value "TRUE" to this attribute. This attribute is a specialization of <i>[objectAttribute]</i> attribute.
<i>logStop</i>	1	RW	The action that allows stopping the log corresponding to the mentioned <i>logTypeID</i> . The action is triggered by assigning value "TRUE" to this attribute. This attribute is a specialization of <i>[objectAttribute]</i> attribute.

D.12 Resource *cmdhPolicy*

D.12.0 Overview

A *[cmdhPolicy]* resource is defined as a specialization of the *<mgmtObj>* resource type as specified in clause 9.6.15. It includes a number of child resources which are referenced by means of *mgmtLink* attributes. Each of these linked child resources represents itself a specialization of the *<mgmtObj>* resource type. These child resources and their child resources are defined in clauses D.12.1 to D.12.8.

The *[cmdhPolicy]* resource represents a set of rules associated with a specific CSE that govern the behaviour of that CSE regarding rejecting, buffering and sending request or response messages via the Mcc reference point. The rules contained in a *[cmdhPolicy]* resource are sub-divided into rules represented by different child resources with different purposes as follows:

- **Defaults:** Defines which CMDH related parameters will be used by default when a request or response message issued by a registrar of the associated CSE or the associated CSE itself contains the *Event Category* parameter but not all other CMDH related parameters and which default *Event Category* parameter shall be used when none is given in the request or response.
- **Limits:** Defines the allowed limits for CMDH related parameters in request or response messages with a given *Event Category* value.

- **Network usage:** Defines the conditions when usage of specific Underlying Networks is allowed for request or response messages with a given *Event Category* value.
- **Buffering:** Defines limits of supported buffer size to be used for storing pending messages with a given *Event Category* value and their priorities when deletion cannot be avoided.

The relationships of *[cmdhPolicy]* resources with other resources and the position within the overall resource structure are depicted in figure D.12.0-1. One or several *[cmdhPolicy]* resources can be assigned as child resources under a parent of *<node>* resource type. The *<node>* resource carrying CMDH policies is linked by means of a *nodeLink* attribute from either the local *<CSEBase>* resource or an instance of a *<remoteCSE>* resource type. This *nodeLink* attribute as well as the reverse *hostedCSELINK* attribute in the *<node>* resource define to which CSE the set of CMDH policies apply whenever this CSE receives requests or responses that need to be forwarded over Mcc reference point. Since only one particular set of CMDH rules can be active for a given CSE at any given point in time, an *[activeCMDHPolicy]* child resource under the parent *<node>* resource that represents the node which hosts the respective CSE is used to point to the active *[cmdhPolicy]* resource that shall be effective for that particular CSE.

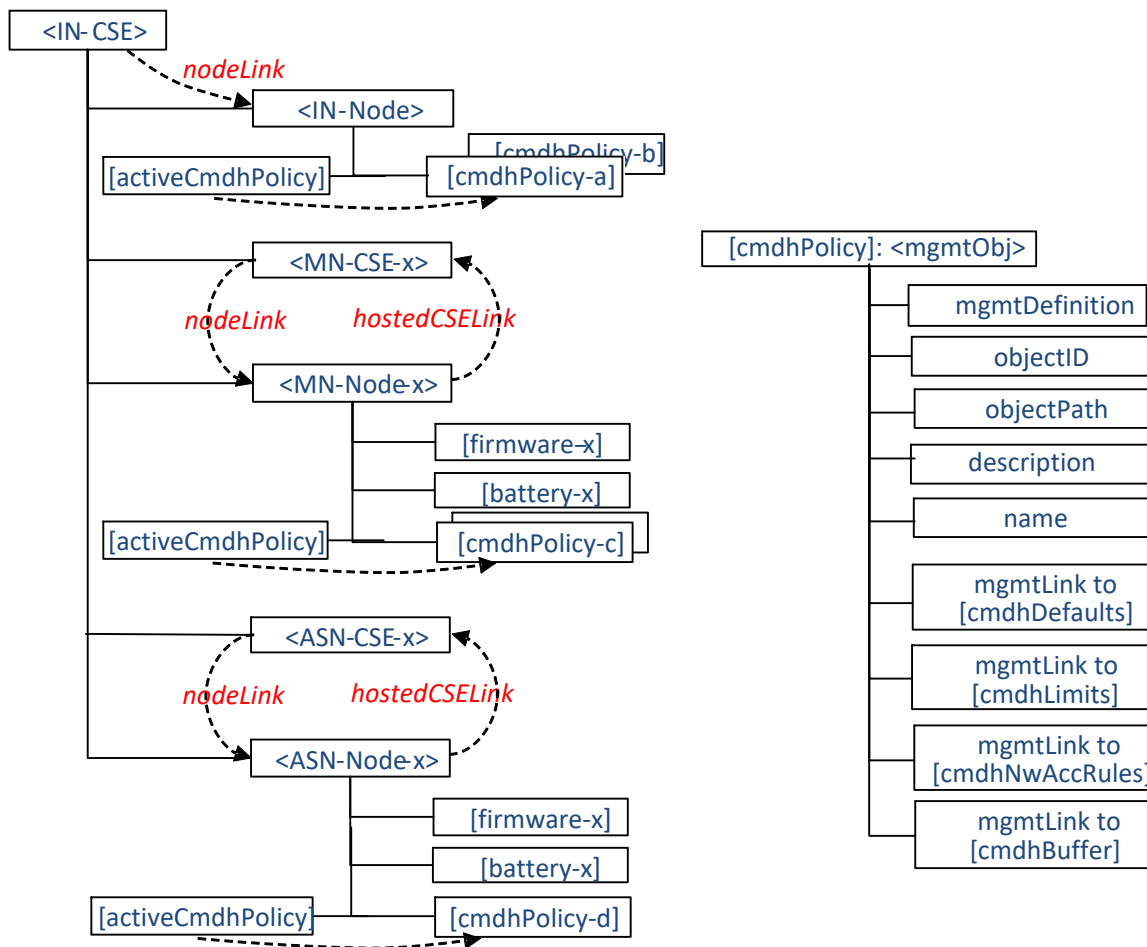

Figure D.12.0-1: Relationships between *[cmdhPolicy]* resource and other resources

When employing external management technology, the *[cmdhPolicy]* resources are assigned under instances of the *<node>* resources that represent the remotely managed field nodes in the IN-CSE performing device management for these nodes. In this scenario, the *[cmdhPolicy]* resources are transferred to the field node by means of the external device management technology applicable for that specific node.

When a field domain node is managed via the Mcc reference point, the *[cmdhPolicy]* resources are provisioned directly to instances of the *<node>* resources in the field domain CSE from an IN-CSE responsible for the device/entity management.

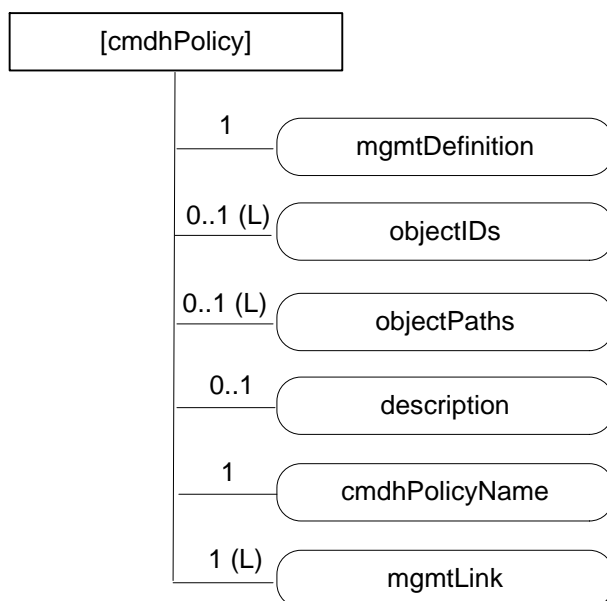

Figure D.12.0-2: Structure of [cmdhPolicy] resource

The [cmdhPolicy] resource shall contain attributes specified in table D.12.0-1.

Table D.12.0-1: Attributes of [cmdhPolicy] resource

Attributes of [cmdhPolicy]	Multiplicity	RW/RO/WO	Description
resourceType	1	RO	See clause 9.6.1.3.
resourceID	1	RO	See clause 9.6.1.3.
resourceName	1	WO	See clause 9.6.1.3.
parentID	1	RO	See clause 9.6.1.3.
expirationTime	1	RW	See clause 9.6.1.3.
accessControlPolicyIDs	0..1 (L)	RW	See clause 9.6.1.3.
creationTime	1	RO	See clause 9.6.1.3.
lastModifiedTime	1	RO	See clause 9.6.1.3.
labels	0..1(L)	RO	See clause 9.6.1.3.
mgmtDefinition	1	WO	See clause 9.6.15. Has fixed value "cmdhPolicy" to indicate the resource is for CMDH policy management.
objectIDs	0..1 (L)	WO	See clause 9.6.15.
objectPaths	0..1 (L)	WO	See clause 9.6.15.
description	0..1	RW	See clause 9.6.15.
cmdhPolicyName	1	RW	A name under which the CMDH policy will be referred. This attribute is a specialization of [objectAttribute] attribute.
mgmtLink	1 (L)	RW	A list containing at least 4 links. <ul style="list-style-type: none"> • 1 link to [cmdhDefaults] resource; • At least 1 or more link(s) to [cmdhLimits] resource(s); • At least 1 or more link(s) to [cmdhNetworkAccessRules] resource(s); • At least 1 or more link(s) to [cmdhBuffer] resource(s).

D.12.1 Resource activeCmdhPolicy

A managed node can have one or more sets of [cmdhPolicy] resources assigned as children.

The [activeCmdhPolicy] resource is used to provide a link to the currently active set of CMDH policies. This identifies which set of CMDH policies is currently actively in use in the corresponding CSE. It allows the device management technology to activate a policy set independently of the download of a new set of CMDH policies in order to avoid potential race conditions. The [activeCmdhPolicy] and [cmdhPolicy] resources are children of the same <node> resource to which these policies apply.

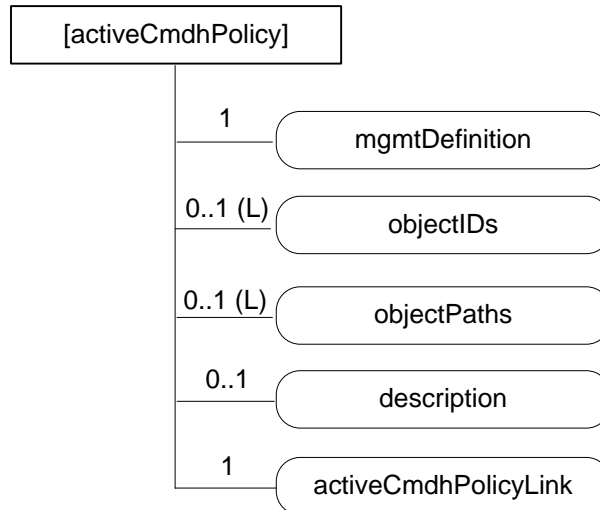

Figure D.12.1-1: Structure of *[activeCmdhPolicy]* resource

The *[activeCmdhPolicy]* resource shall contain attributes specified in table D.12.1-1.

Table D.12.1-1: Attributes of *[activeCmdhPolicy]* resource

Attributes of <i>[activeCmdhPolicy]</i>	Multiplicity	RW/ RO/ WO	Description
<i>resourceType</i>	1	RO	See clause 9.6.1.3.
<i>resourceID</i>	1	RO	See clause 9.6.1.3.
<i>resourceName</i>	1	WO	See clause 9.6.1.3.
<i>parentID</i>	1	RO	See clause 9.6.1.3.
<i>expirationTime</i>	1	RW	See clause 9.6.1.3.
<i>accessControlPolicyIDs</i>	0..1 (L)	RW	See clause 9.6.1.3.
<i>creationTime</i>	1	RO	See clause 9.6.1.3.
<i>lastModifiedTime</i>	1	RO	See clause 9.6.1.3.
<i>labels</i>	0..1(L)	RO	See clause 9.6.1.3.
<i>mgmtDefinition</i>	1	WO	See clause 9.6.15. Has fixed value " <i>activeCmdhPolicy</i> ".
<i>objectIDs</i>	0..1 (L)	WO	See clause 9.6.15.
<i>objectPaths</i>	0..1 (L)	WO	See clause 9.6.15.
<i>description</i>	0..1	RW	See clause 9.6.15.
<i>activeCmdhPolicyLink</i>	1	RW	The resource ID of the <i>[cmdhPolicy]</i> resource instance containing the CMDH policies that are currently active for the associated CSE, i.e. for the CSE which is hosted by the node that is represented by the parent <i><node></i> resource.

D.12.2 Resource *cmdhDefaults*

The *[cmdhDefaults]* resource is used to define default values that shall be used for CMDH-related parameters when requests issued by Originators (registered AEs or functions inside the CSE itself) do not contain a value for the parameters *Event Category*, *Request Expiration Timestamp*, *Result Expiration Timestamp*, *Operation Execution Time*, *Result Persistence*, and/or *Delivery Aggregation*.

Upon receiving a request, the CSE shall first look if the *Event Category* parameter is set. If not, the CSE shall use the *[cmdhDefEcValue]* resources (see below) to determine a value that should be used for *Event Category*.

Then, if any of the parameters *Request Expiration Timestamp*, *Result Expiration Timestamp*, *Operation Execution Time*, *Result Persistence* or *Delivery Aggregation* is not set, the CSE shall use the *[cmdhEcDefParamValues]* resources (see below) to populate the missing parameters (and only the missing ones).

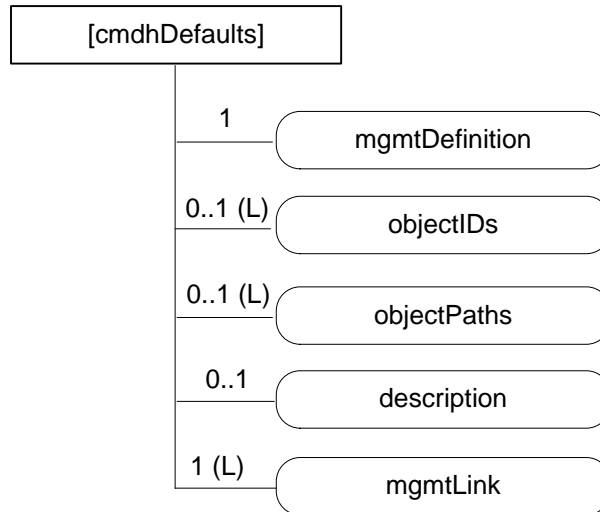

Figure D.12.2-1: Structure of [cmdhDefaults] resource

The [cmdhDefaults] resource shall contain attributes specified in table D.12-2-1.

Table D.12.2-1: Attributes of [cmdhDefaults] resource

Attributes of [cmdhDefaults]	Multiplicity	RW/RO/WO	Description
resourceType	1	RO	See clause 9.6.1.3.
resourceID	1	RO	See clause 9.6.1.3.
resourceName	1	WO	See clause 9.6.1.3.
parentID	1	RO	See clause 9.6.1.3.
expirationTime	1	RW	See clause 9.6.1.3.
accessControlPolicyIDs	0..1 (L)	RW	See clause 9.6.1.3.
creationTime	1	RO	See clause 9.6.1.3.
lastModifiedTime	1	RO	See clause 9.6.1.3.
labels	0..1(L)	RO	See clause 9.6.1.3.
mgmtDefinition	1	WO	See clause 9.6.15. Has fixed value "cmdhDefaults".
objectIDs	0..1 (L)	WO	See clause 9.6.15.
objectPaths	0..1 (L)	WO	See clause 9.6.15.
description	0..1	RW	See clause 9.6.15.
mgmtLink	1 (L)	RW	A list containing at least 2 links: <ul style="list-style-type: none"> • One or more link(s) to [cmdhDefEcValue] resource(s); and • One or more link(s) to [cmdhEcDefParamValues] resource(s).

D.12.3 Resource cmdhDefEcValue

The [cmdhDefEcValue] resource is used to define a value for the **Event Category** parameter of an incoming request when it is not defined.

Upon receiving a request, the CSE will go through all the [cmdhDefEcValue] resources (in the order of their *order* attribute), check the *requestOrigin* and any present *requestContext* and *requestCharacteristics* attributes to see if they match (see description of matching), and if they all do, assign the value stored in the *defEcValue* attribute to the **Event Category** parameter.

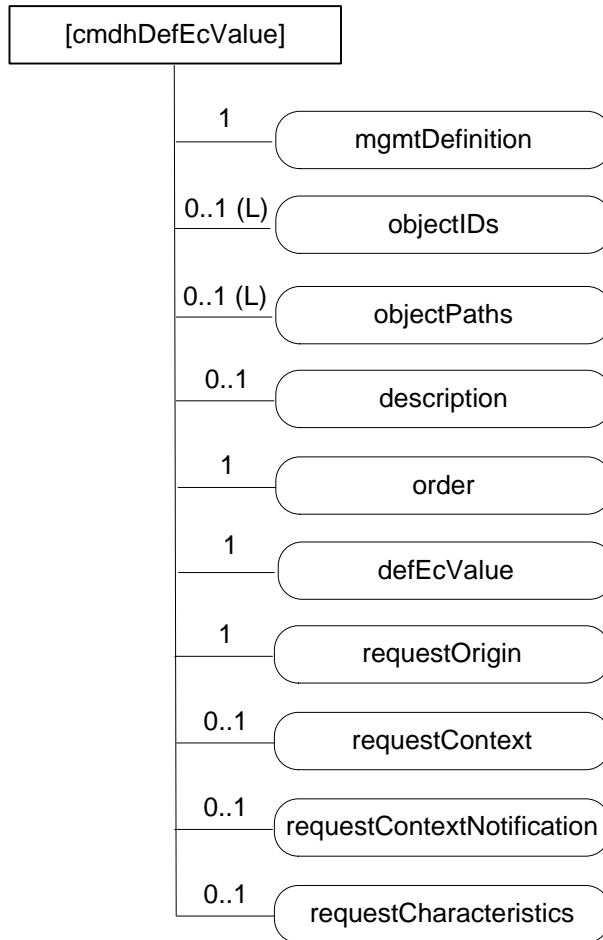

Figure D.12.3-1: Structure of [cmdhDefEcValue] resource

The [cmdhDefEcValue] resource shall contain attributes specified in table D.12.3-1.

Table D.12.3-1: Attributes of [cmdhDefEcValue] resource

Attributes of [cmdhDefEcValue]	Multiplicity	RW/RO/WO	Description
resourceType	1	RO	See clause 9.6.1.3.
resourceID	1	RO	See clause 9.6.1.3.
resourceName	1	WO	See clause 9.6.1.3.
parentID	1	RO	See clause 9.6.1.3.
expirationTime	1	RW	See clause 9.6.1.3.
accessControlPolicyIDs	0..1 (L)	RW	See clause 9.6.1.3.
creationTime	1	RO	See clause 9.6.1.3.
lastModifiedTime	1	RO	See clause 9.6.1.3.
labels	0..1(L)	RO	See clause 9.6.1.3.
mgmtDefinition	1	WO	See clause 9.6.15. Has fixed value "cmdhDefEcValue".
objectIDs	0..1 (L)	WO	See clause 9.6.15.
objectPaths	0..1 (L)	WO	See clause 9.6.15.
description	0..1	RW	See clause 9.6.15.
order	1	RW	The index indicating in which order the [cmdhDefEcValue] resource will be treated by the CSE to determine a value for the Event Category parameter. This attribute is a specialization of [objectAttribute] attribute.
defEcValue	1	RW	The actual value to use for the Event Category parameter if the conditions expressed in the requestOrigin, requestContext and requestCharacteristics attributes all match. If none of these attributes are defined, then the defEcValue shall be applied. This attribute is a specialization of [objectAttribute] attribute.

Attributes of [cmdhDefEcValue]	Multiplicity	RW/RO/WO	Description
requestOrigin	1	RW	<p>The <i>requestOrigin</i> attribute is a list of zero or more local <i>AE-IDs</i>, <i>App-IDs</i>, or the strings 'localAE' or 'thisCSE'.</p> <p>When an <i>AE-ID</i> appears in the <i>requestOrigin</i> attribute, the default Event Category value defined inside the <i>defEcValue</i> attribute is applicable for the Event Category if the request was issued by that specific Application Entity.</p> <p>When an <i>App-ID</i> appears in the <i>requestOrigin</i> attribute, the default Event Category value defined inside the <i>defEcValue</i> attribute is applicable for the Event Category if the request was issued by the AE with that <i>App-ID</i> unless covered by another [cmdhDefEcValue] resource with a <i>requestOrigin</i> attribute containing its specific <i>AE-ID</i>.</p> <p>When the string 'localAE' appears in the <i>requestOrigin</i> attribute, the default Event Category value defined inside the <i>defEcValue</i> attribute is applicable for the Event Category for requests issued by all local AEs unless covered by another [cmdhDefEcValue] resource with a <i>requestOrigin</i> attribute containing the specific <i>AE-ID</i> or <i>App-ID</i> of the Originator of the request.</p> <p>When the string 'thisCSE' appears in the <i>requestOrigin</i> attribute, the default Event Category value defined inside the <i>defEcValue</i> attribute is applicable for the Event Category for requests that are originating from within the registrar CSE.</p> <p>The Hosting CSE shall contain at least one [cmdhDefEcValue] resource that contains 'localAE' in the <i>requestOrigin</i> attribute and has no <i>requestContext</i> and no <i>requestCharacteristics</i> attribute.</p> <p>The Hosting CSE shall contain at least one [cmdhDefEcValue] resource that contains 'thisCSE' in the <i>requestOrigin</i> attribute and has no <i>contextCondition</i> and no <i>requestCharacteristics</i> attribute.</p> <p>This attribute is a specialization of [objectAttribute] attribute.</p>
requestContext	0..1	RW	<p>The <i>requestContext</i> attribute represents the Dynamic Context condition under which the default Event Category value defined inside the <i>defEcValue</i> attribute is applicable for the Event Category.</p> <p>This may refer to conditions such as current battery status, or current network signal strength. This attribute is a specialization of [objectAttribute] attribute.</p>
requestContextNotification	0..1	RW	<p>True or false. If set to true, then this CSE will establish a subscription to the dynamic context information defined in the <i>requestContext</i> attribute as well as a subscription to this [cmdhDefEcValue] resource for all AEs corresponding to the <i>AE-ID</i> or an <i>App-ID</i> appearing in the <i>requestOrigin</i> attribute. Both, changes in the context information and changes to the [cmdhDefEcValue] resource will be notified to the respective AEs. The subscription(s) is/are established when the [cmdhDefEcValue] is provisioned or updated. This attribute is a specialization of [objectAttribute] attribute.</p>
requestCharacteristics	0..1	RW	<p>The <i>requestCharacteristics</i> attribute represents conditions pertaining to the request itself, such as the requested Response Type or other parameters of the request. This attribute is a specialization of [objectAttribute] attribute.</p>

D.12.4 Resource cmdhEcDefParamValues

The *[cmdhEcDefParamValues]* resource is used to represent a specific set of default values for the CMDH related parameters *Request Expiration Timestamp*, *Result Expiration Timestamp*, *Operation Execution Time*, *Result Persistence* and *Delivery Aggregation* that are applicable for a given *Event Category* if these parameters are not specified in the request.

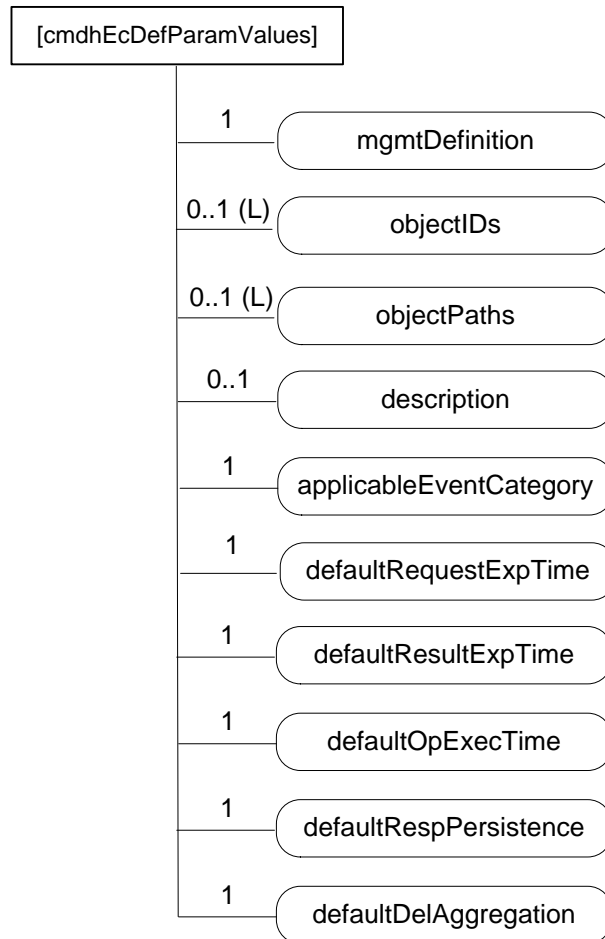

Figure D.12.4-1: Structure of *[cmdhEcDefParamValues]* resource

The [cmdhEcDefParamValues] resource shall contain attributes specified in table D.12.4-1.

Table D.12.4-1: Attributes of [cmdhEcDefParamValues] resource

Attributes of [cmdhEcDefParamValues]	Multiplicity	RW/RO/WO	Description
resourceType	1	RO	See clause 9.6.1.3.
resourceID	1	RO	See clause 9.6.1.3.
resourceName	1	WO	See clause 9.6.1.3.
parentID	1	RO	See clause 9.6.1.3.
expirationTime	1	RW	See clause 9.6.1.3.
accessControlPolicyIDs	0..1 (L)	RW	See clause 9.6.1.3.
creationTime	1	RO	See clause 9.6.1.3.
lastModifiedTime	1	RO	See clause 9.6.1.3.
labels	0..1(L)	RO	See clause 9.6.1.3.
mgmtDefinition	1	WO	See clause 9.6.15. Has fixed value "cmdhEcDefParamValues".
objectIDs	0..1 (L)	WO	See clause 9.6.15.
objectPaths	0..1 (L)	WO	See clause 9.6.15.
description	0..1	RW	See clause 9.6.15.
applicableEventCategory	1	RW	<p>This attribute defines the event categories for which this set of default parameters defined in this [cmdhEcDefParamValues] resource are applicable. This attribute is a list of zero or more Event Category values, or the string 'default'.</p> <p>When an Event Category value appears in the applicableEventCategory attribute, the set of default parameters defined in this [cmdhEcDefParamValues] resource are applicable for requests associated with that specific Event Category value.</p> <p>When the string 'default' appears in the applicableEventCategory attribute, the set of default parameters defined in this [cmdhEcDefParamValues] resource are applicable for all requests whose associated Event Category value is not listed in the applicableEventCategory attribute of any other provisioned [cmdhEcDefParamValues] resource on the Hosting CSE.</p> <p>A specific Event Category value shall appear at most once in any of the applicableEventCategory attributes of any of the provisioned [cmdhEcDefParamValues] resources on the Hosting CSE.</p> <p>The string 'default' shall appear exactly once in any of the applicableEventCategory attributes of any of the provisioned [cmdhEcDefParamValues] resources on the Hosting CSE.</p> <p>This attribute is a specialization of [objectAttribute] attribute.</p>
defaultRequestExpTime	1	RW	Default value for the Request Expiration Timestamp parameter in a request when the Request Expiration Timestamp parameter of the request is not set. This attribute is a specialization of [objectAttribute] attribute.
defaultResultExpTime	1	RW	Default value for the Result Expiration Timestamp parameter in a request when the Result Expiration Timestamp parameter of the request is not set. This attribute is a specialization of [objectAttribute] attribute.
defaultOpExecTime	1	RW	Default value for the Operation Execution Time parameter in a request when the Operation Execution Time parameter of the request is not set. This attribute is a specialization of [objectAttribute] attribute.
defaultRespPersistence	1	RW	Default value for the Result Persistence parameter in a request when the Result Persistence parameter of the request is not set. This attribute is a specialization of [objectAttribute] attribute.

Attributes of [cmdhEcDefParamValues]	Multiplicity	RW/RO/WO	Description
defaultDelAggregation	1	RW	Default value for the Delivery Aggregation parameter in a request when the Delivery Aggregation parameter of the request is not set. This attribute is a specialization of [objectAttribute] attribute.

D.12.5 Resource cmdhLimits

The [cmdhLimits] resource is used to define limits for CMDH related parameter values used in requests issued by Originators (registered AEs or functions inside the CSE itself). When an incoming request is processed that does not comply with the limits defined by the corresponding [cmdhLimits] resource, the request shall be rejected by the CSE.

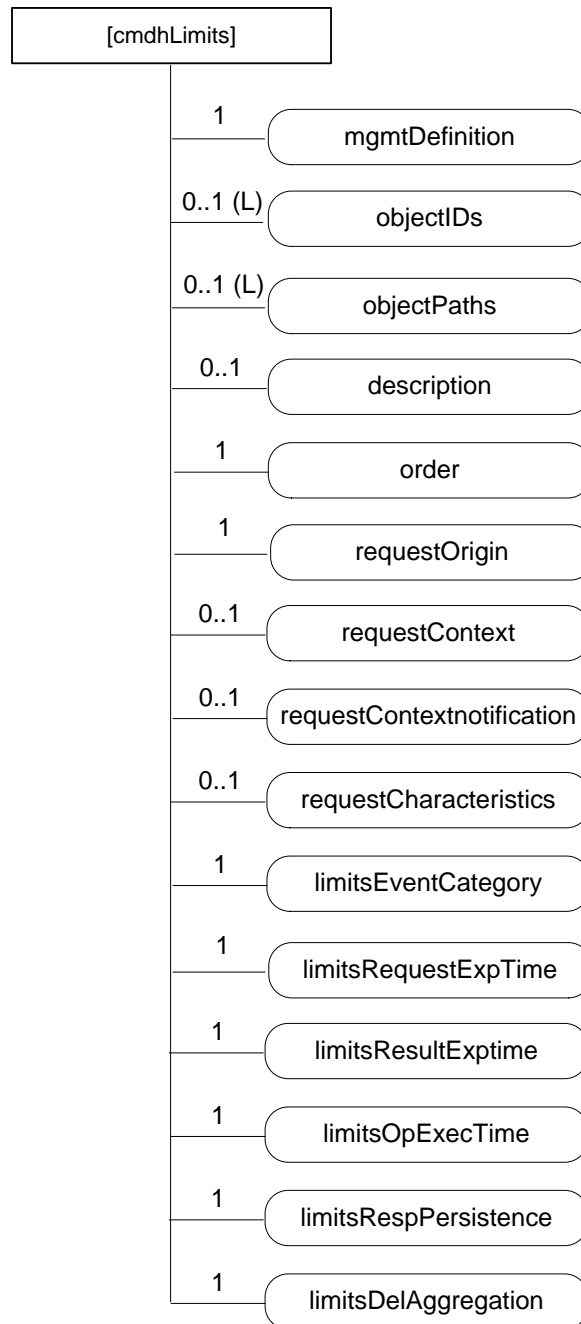

Figure D.12.5-1: Structure of [cmdhLimits] resource

The [cmdhLimits] resource shall contain attributes specified in table D.12.5-1.

Table D.12.5-1: Attributes of [cmdhLimits] resource

Attributes of [cmdhLimits]	Multiplicity	RW/RO/WO	Description
resourceType	1	RO	See clause 9.6.1.3.
resourceID	1	RO	See clause 9.6.1.3.
resourceName	1	WO	See clause 9.6.1.3.
parentID	1	RO	See clause 9.6.1.3.
expirationTime	1	RW	See clause 9.6.1.3.
accessControlPolicyIDs	0..1 (L)	RW	See clause 9.6.1.3.
creationTime	1	RO	See clause 9.6.1.3.
lastModifiedTime	1	RO	See clause 9.6.1.3.
labels	0..1(L)	RO	See clause 9.6.1.3.
mgmtDefinition	1	WO	See clause 9.6.15. Has fixed value "cmdhLimits".
objectIDs	0..1 (L)	WO	See clause 9.6.15.
objectPaths	0..1 (L)	WO	See clause 9.6.15.
description	0..1	RW	See clause 9.6.15.
order	1	RW	The index indicating in which order the [cmdhLimits] resource will be treated by the CSE to determine a value for the limit parameters. This attribute is a specialization of [objectAttribute] attribute.
requestOrigin	1	RW	<p>The requestOrigin attribute is a list of zero or more local AE-IDs, App-IDs, or the strings 'localAE' or 'thisCSE'.</p> <p>When an AE-ID appears in the requestOrigin attribute, the CMDH parameter limits defined inside [cmdhLimits] resources are applicable for requests issued by that specific Application Entity.</p> <p>When an App-ID appears in the requestOrigin attribute, the CMDH parameter limits defined inside [cmdhLimits] resources are applicable for requests issued by the AE with that App-ID unless already covered by another [cmdhLimits] resource with a requestOrigin attribute containing its specific AE-ID.</p> <p>When the string 'localAE' appears in the requestOrigin attribute, CMDH parameter limits defined inside [cmdhLimits] resources are applicable for all local AEs unless covered by another [cmdhLimits] resource with a requestOrigin attribute containing the specific AE-ID or App-ID of the Originator of the request.</p> <p>When the string 'thisCSE' appears in the requestOrigin attribute, CMDH parameter limits defined inside [cmdhLimits] resources are applicable for all requests that are originating from within the Hosting CSE.</p> <p>The Hosting CSE shall contain at least one [cmdhLimits] resource that contains 'localAE' in the requestOrigin attribute and has no contextCondition and no requestCharacteristics attribute.</p> <p>The Hosting CSE shall contain at least one [cmdhLimits] resource that contains 'thisCSE' in the requestOrigin attribute and has no requestContext and no requestCharacteristics attribute.</p> <p>This attribute is a specialization of [objectAttribute] attribute.</p>
requestContext	0..1	RW	<p>The requestContext attribute represents the Dynamic Context condition under which CMDH parameter limits defined inside the [cmdhLimits] resource is applicable.</p> <p>This may refer to conditions such as current battery status, or current network signal strength. This attribute is a specialization of [objectAttribute] attribute.</p>

Attributes of [cmdhLimits]	Multiplicity	RW/RO/WO	Description
<i>requestContextNotification</i>	0..1	RW	True or false. If set to true, then this CSE will establish a subscription to the dynamic context information defined in the <i>requestContext</i> attribute as well as a subscription to this [cmdhLimits] resource for all AEs corresponding to the <i>AE-ID</i> or an <i>App-ID</i> appearing in the <i>requestOrigin</i> attribute. Both, changes in the context information and changes to the [cmdhLimits] resource will be notified to the respective AEs. The subscription(s) is/are established when the [cmdhLimits] is provisioned or updated. This attribute is a specialization of [objectAttribute] attribute.
<i>requestCharacteristics</i>	0..1	RW	The <i>requestCharacteristics</i> attribute represents conditions pertaining to the request itself, such as the requested Response Type or other attributes of the request. This attribute is a specialization of [objectAttribute] attribute.
<i>limitsEventCategory</i>	1	RW	Allowed values for the Event Category parameter) in a request of any of the Originators indicated in the <i>requestOrigin</i> attribute. This attribute is a specialization of [objectAttribute] attribute.
<i>limitsRequestExpTime</i>	1	RW	Range of allowed values for the Request Expiration Timestamp parameter in a request of any of the Originators indicated in the <i>requestOrigin</i> attribute. This attribute is a specialization of [objectAttribute] attribute.
<i>limitsResultExpTime</i>	1	RW	Range of allowed values for the Result Expiration Timestamp parameter in a request of any of the Originators indicated in the <i>requestOrigin</i> attribute. This attribute is a specialization of [objectAttribute] attribute.
<i>limitsOpExecTime</i>	1	RW	Range of allowed values for the Operation Execution Time parameter in a request of any of the Originators indicated in the <i>requestOrigin</i> attribute. This attribute is a specialization of [objectAttribute] attribute.
<i>limitsRespPersistence</i>	1	RW	Range of allowed values for the Result Persistence parameter in a request of any of the Originators indicated in the <i>requestOrigin</i> attribute. This attribute is a specialization of [objectAttribute] attribute.
<i>limitsDelAggregation</i>	1	RW	List of allowed values for the Delivery Aggregation parameter in a request of any of the Originators indicated in the <i>requestOrigin</i> attribute. This attribute is a specialization of [objectAttribute] attribute.

D.12.6 Resource cmdhNetworkAccessRules

The [cmdhNetworkAccessRules] resource is used to define the usage of Underlying Networks for forwarding information to other CSEs during processing of CMDH-related requests in a CSE. When an incoming request is processed by a CSE, it can only use Underlying Networks for forwarding any information to other CSEs in compliance with the rules defined by the corresponding [cmdhNetworkAccessRules] resource.

If a request cannot be successfully completed in compliance with the rules defined in the corresponding [cmdhNetworkAccessRules] resource, that request shall either be rejected in case it has not already been accepted by the CSE or it has to be purged. Error reporting on failed CMDH processing depends on error reporting parameters.

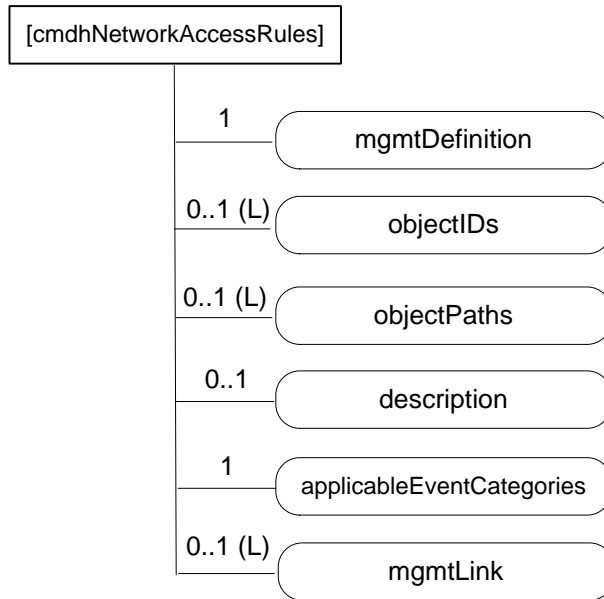

Figure D.12.6-1: Structure of [cmdhNetworkAccessRules] resource

If a [cmdhNetworkAccessRules] resource has no *mgmtLink* attribute to [cmdhNwAccessRules] resources (i.e. multiplicity of 0), requests that match with the *applicableEventCategorie* attribute (see description of attributes in table D.12.6-1) will not be allowed to use any Underlying Network for forwarding information, i.e. such requests need to be rejected.

The *[cmdhNetworkAccessRules]* resource shall contain attributes specified in table D.12.6-1.

Table D.12.6-1: Attributes of *[cmdhNetworkAccessRules]* resource

Attributes of <i>[cmdhNetworkAccessRules]</i>	Multiplicity	RW/RO/WO	Description
<i>resourceType</i>	1	RO	See clause 9.6.1.3.
<i>resourceID</i>	1	RO	See clause 9.6.1.3.
<i>resourceName</i>	1	WO	See clause 9.6.1.3.
<i>parentID</i>	1	RO	See clause 9.6.1.3.
<i>expirationTime</i>	1	RW	See clause 9.6.1.3.
<i>accessControlPolicyIDs</i>	0..1 (L)	RW	See clause 9.6.1.3.
<i>creationTime</i>	1	RO	See clause 9.6.1.3.
<i>lastModifiedTime</i>	1	RO	See clause 9.6.1.3.
<i>labels</i>	0..1(L)	RO	See clause 9.6.1.3.
<i>mgmtDefinition</i>	1	WO	See clause 9.6.15. Has fixed value " <i>cmdhNetworkAccessRules</i> ".
<i>objectIDs</i>	0..1 (L)	WO	See clause 9.6.15.
<i>objectPaths</i>	0..1 (L)	WO	See clause 9.6.15.
<i>description</i>	0..1	RW	See clause 9.6.15.
<i>applicableEventCategories</i>	1	RW	<p>This attribute defines for which requests the rules contained in <i>[cmdhNwAccessRule]</i> resources linked from this <i>[cmdhNetworkAccessRules]</i> resource shall be applied.</p> <p>This attribute is a list of zero or more Event Category values, or the string 'default'.</p> <p>When an Event Category value appears in the <i>applicableEventCategories</i> attribute, the network usage rules defined inside <i>[cmdhNwAccessRule]</i> child resources are applicable for requests associated with that specific Event Category value.</p> <p>When the string 'default' appears in the <i>applicableEventCategories</i> attribute, the network usage rules defined inside <i>[cmdhNwAccessRule]</i> child resources are applicable for all requests whose associated Event Category value is not listed in the <i>applicableEventCategories</i> attribute of any other provisioned <i>[cmdhNetworkAccessRules]</i> resource on the Hosting CSE.</p> <p>A specific Event Category value shall appear at most once in any of the <i>applicableEventCategories</i> attributes of any of the provisioned <i>[cmdhNetworkAccessRules]</i> resources on the Hosting CSE.</p> <p>The string 'default' shall appear exactly once in any of the <i>applicableEventCategories</i> attributes of any of the provisioned <i>[cmdhNetworkAccessRules]</i> resources on the Hosting CSE.</p> <p>This attribute is a specialization of <i>[objectAttribute]</i> attribute.</p>
<i>mgmtLink</i>	0..1 (L)	RW	List of link(s) to <i>[cmdhNwAccessRule]</i> resource(s).

D.12.7 Resource *cmdhNwAccessRule*

The *[cmdhNwAccessRule]* resource is used define limits in usage of specific Underlying Networks for forwarding information to other CSEs during processing of CMDH-related requests.

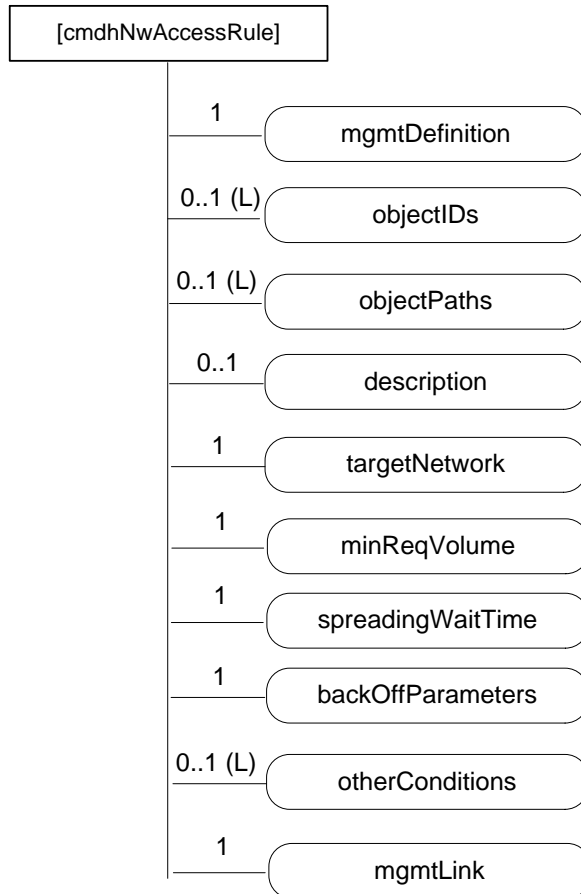

Figure D.12.7-1: Structure of [cmdhNwAccessRule] resource

Requests matching the *applicableEventCategories* attribute of the parent [cmdhNetworkAccessRules] resource of this [cmdhNwAccessRule] resource are processed for forwarding to other CSEs. The Underlying Networks allowed for those Requests are indicated by the *targetNetwork* attribute. The allowed schedule is indicated by the <schedule> resource pointed at by the *mgmtLink* attribute (see description of attributes in table D.12.7-1).

The [cmdhNwAccessRule] resource shall contain attributes specified in table D.12.7-1.

Table D.12.7-1: Attributes of [cmdhNwAccessRule] resource

Attributes of [cmdhNwAccessRule]	Multiplicity	RW/RO/WO	Description
<i>resourceType</i>	1	RO	See clause 9.6.1.3.
<i>resourceID</i>	1	RO	See clause 9.6.1.3.
<i>resourceName</i>	1	WO	See clause 9.6.1.3.
<i>parentID</i>	1	RO	See clause 9.6.1.3.
<i>expirationTime</i>	1	RW	See clause 9.6.1.3.
<i>accessControlPolicyIDs</i>	0..1 (L)	RW	See clause 9.6.1.3.
<i>creationTime</i>	1	RO	See clause 9.6.1.3.
<i>lastModifiedTime</i>	1	RO	See clause 9.6.1.3.
<i>labels</i>	0..1(L)	RO	See clause 9.6.1.3.
<i>mgmtDefinition</i>	1	WO	See clause 9.6.15. Has fixed value "cmdhNwAccessRules".
<i>objectIDs</i>	0..1 (L)	WO	See clause 9.6.15.
<i>objectPaths</i>	0..1 (L)	WO	See clause 9.6.15.
<i>description</i>	0..1	RW	See clause 9.6.15.

Attributes of [cmdhNwAccessRule]	Multiplicity	RW/ RO/ WO	Description
targetNetwork	1	RW	<p>The <i>targetNetwork</i> attribute defines for which Underlying Networks the usage limits contained in this [cmdhNwAccessRule] resource shall be applied.</p> <p>The <i>targetNetwork</i> attribute is a list of one or more strings identifying names of Underlying Networks or the string 'default'. (See note).</p> <p>When a name of an Underlying Network appears in the <i>targetNetwork</i> attribute, the usage limits contained in this [cmdhNwAccessRule] resource shall be applied for usage of that specific Underlying Network when processing requests matching with the parent [cmdhNetworkAccessRules] resource's <i>applicableEventCategories</i> attribute.</p> <p>When the string 'default' appears in the <i>targetNetwork</i> attribute, the usage limits contained in this [cmdhNwAccessRule] resource shall be applied for usage of all Underlying Networks that are not listed with their specific name in the <i>targetNetwork</i> attribute of any other [cmdhNwAccessRule] child resource under the same parent [cmdhNetworkAccessRules] resource when processing requests matching with the parent [cmdhNetworkAccessRules] resource's <i>targetNetwork</i>.</p> <p>Each Underlying Network name or the string 'default' shall appear at most once in any of the <i>targetNetwork</i> attributes of any of the provisioned [cmdhNwAccessRule] child resources under the same parent [cmdhNetworkAccessRules] resource.</p> <p>This attribute is a specialization of [objectAttribute] attribute.</p>
minReqVolume	1	RW	<p>Minimum amount of data that needs to be aggregated before any of the Underlying Networks matching with the <i>targetNetwork</i> attribute of this [cmdhNwAccessRule] resource can be used for forwarding information to other CSEs.</p>
spreadingWaitTime	1	RW	<p>This parameter consists of a number SWT such that before accessing the underlying network (typically to forward an incoming request), the CSE will wait for an additional amount of time randomly chosen between 0 and SWT.</p> <p>This attribute is a specialization of [objectAttribute] attribute.</p>
backOffParameters	1	RW	<p>Parameters that define how usage of any of the Underlying Networks matching with the <i>targetNetwork</i> attribute of this [cmdhNwAccessRule] resource shall be handled when attempts to use such networks have failed.</p> <p>The <i>backOffParameters</i> attribute can either:</p> <ul style="list-style-type: none"> - Consist of the following values: <ul style="list-style-type: none"> • An initial back-off time IBT that defines how long a CSE needs to wait before attempting to use a specific Underlying Network again after a first failed attempt • An additional back-off time ABT increment that defines by how much the back-off time shall be increased after each additional consecutive failed attempt to use the same Underlying Network without success • A maximum back-off time MBT that defines the maximum wait time before attempting to use an Underlying Network again after previous failures. • An optional random back-off time RBT that will make the network access actually occur randomly in a time window starting at IBT+n.ABT and ending at IBT+n.ABT+RBT (if RBT is not present, then no randomization occurs and the access takes place at IBT+n.ABT)

Attributes of [cmdhNwAccessRule]	Multiplicity	RW/RO/WO	Description
			<p>In which case the back-off timers apply for any action attempted onto the network to fulfil the incoming request (registration to the network, opening of data session, etc.)</p> <p>- Or consist of an array of several elements, each composed like this [NWA, IBT, ABT, MBT, (optional RBT)] where IBT, ABT, MBT and RBT are defined above, and where NWA is the name of a specific action that is actually attempted on the network. The present document defines the following network action names, that can be used when the CSE knows that it uses an underlying network where these actions are valid:</p> <ul style="list-style-type: none"> • "cellular-registration" for an IMSI CS-Registration onto 3GPP-compliant cellular networks • "cellular-attach" for a GPRS Attach onto 3GPP-compliant cellular networks • "cellular-pdpctxact" for a PDP Context Activation onto 3GPP-compliant cellular networks • "cellular-sms" for SMS originating from this CSE onto 3GPP-compliant cellular networks • "default" for all other actions not already declared in this backOffParameters attribute (this action will be used by the CSE when it does not know which kind of underlying network it uses) <p>In which case the back-off timers apply only for the specified actions.</p> <p>This attribute is a specialization of [objectAttribute] attribute.</p>
otherConditions	0..1 (L)	RW	List of additional conditions that need to be fulfilled before any of the Underlying Networks matching with the targetNetwork attribute of this [cmdhNwAccessRule] resource can be used for forwarding information to other CSEs. This attribute is a specialization of [objectAttribute] attribute.
mgmtLink	1	RW	Link to an instance allowedSchedule of a <schedule> resource as defined in clause 9.6.9. This attribute is a specialization of [objectAttribute] attribute.
NOTE: A naming convention for Underlying Network names is not supported in this release of the specification.			

D.12.8 Resource cmdhBuffer

The [cmdhBuffer] resource is used to define limits in usage of buffers for temporarily storing information that needs to be forwarded to other CSEs during processing of CMDH-related requests in a CSE. When an incoming request is processed by a CSE, it can only use buffers for temporary storage in compliance with the rules defined by the corresponding [cmdhBuffer] resource.

If a request cannot be processed in compliance with the rules defined in the corresponding [cmdhBuffer] resource, that request shall either be rejected in case it has not already been accepted by the CSE or it has to be purged. Error reporting on failed CMDH processing depends on error reporting parameters.

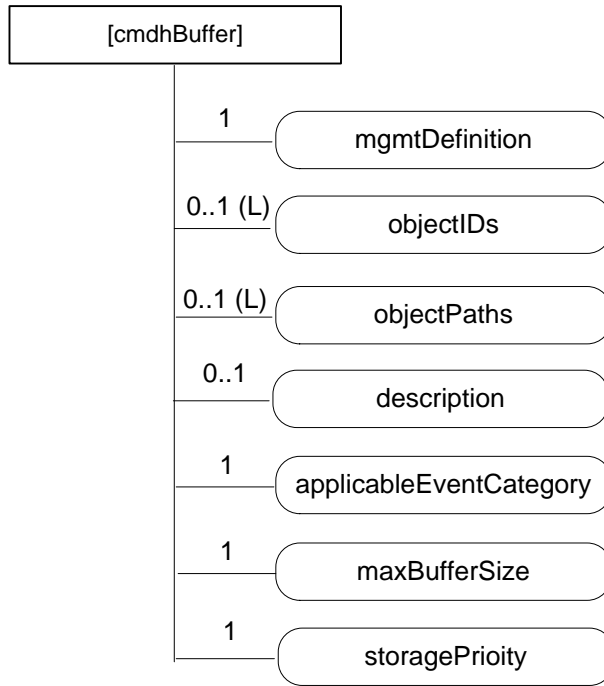

Figure D.12.8-1: Structure of [cmdhBuffer] resource

The [cmdhBuffer] resource shall contain attributes specified in table D.12.8-1.

Table D.12.8-1: Attributes of [cmdhBuffer] resource

Attributes of [cmdhBuffer]	Multiplicity	RW/RO/WO	Description
resourceType	1	RO	See clause 9.6.1.3.
resourceID	1	RO	See clause 9.6.1.3.
resourceName	1	WO	See clause 9.6.1.3.
parentID	1	RO	See clause 9.6.1.3.
expirationTime	1	RW	See clause 9.6.1.3.
accessControlPolicyIDs	0..1 (L)	RW	See clause 9.6.1.3.
creationTime	1	RO	See clause 9.6.1.3.
lastModifiedTime	1	RO	See clause 9.6.1.3.
labels	0..1(L)	RO	See clause 9.6.1.3.
mgmtDefinition	1	WO	See clause 9.6.15. Has fixed value "cmdhBuffer".
objectIDs	0..1 (L)	WO	See clause 9.6.15.
objectPaths	0..1 (L)	WO	See clause 9.6.15.
description	0..1	RW	See clause 9.6.15.

Attributes of [cmdhBuffer]	Multiplicity	RW/RO/WO	Description
<i>applicableEventCategory</i>	1	RW	<p>The <i>applicableEventCategory</i> attribute defines for which requests the limits contained in this [cmdhBuffer] resource shall be applied.</p> <p>The <i>applicableEventCategory</i> attribute is a list of zero or more Event Category values, or the string 'default'.</p> <p>When an Event Category value appears in the <i>applicableEventCategory</i> attribute, the buffer usage limits defined inside this [cmdhBuffer] resource are applicable for requests associated with that specific Event Category value.</p> <p>When the string 'default' appears in the <i>applicableEventCategory</i> attribute, the buffer usage limits defined inside this [cmdhBuffer] resource are applicable for all requests whose associated Event Category value is not listed in the <i>applicableEventCategory</i> attribute of any other provisioned [cmdhBuffer] resource on the Hosting CSE.</p> <p>A specific Event Category value shall appear at most once in any of the <i>applicableEventCategory</i> attributes of any of the provisioned [cmdhBuffer] resources on the Hosting CSE.</p> <p>The string 'default' shall appear exactly once in any of the <i>applicableEventCategory</i> attributes of any of the provisioned [cmdhBuffer] resources on the Hosting CSE.</p> <p>This attribute is a specialization of [objectAttribute] attribute.</p>
<i>maxBufferSize</i>	1	RW	<p>Maximum amount of memory that can be used for buffering requests matching with the <i>applicableEventCategory</i> attribute of this [cmdhBuffer] resource. This attribute is a specialization of [objectAttribute] attribute.</p>
<i>storagePriority</i>	1	RW	<p>Storage priority for data that is stored for buffering requests matching with the attribute of this [cmdhBuffer] resource.</p> <p>The storage priority defines the how to handle purging of buffered data when buffer memory is exhausted and buffered requests need to be purged. Buffered requests associated with a lower storage priority shall be purged before buffered requests with a higher storage priority. The range of storage priority is from 1 to 10. This attribute is a specialization of [objectAttribute] attribute.</p>

Annex E (informative): CSE Minimum Provisioning

The present clause defines the minimum set of resources instantiated in a CSE node with the scope to make it ready to provide services to entities that will register to.

For the purpose of the initial configuration two roles are identified:

- **superuser:** this role allows the full CSE control according to infrastructure provider policies. Only one superuser role is allowed per CSE;
- **user:** is the role associated to an AE that will register itself to Registrar CSE. More than one user roles are allowed per CSE. More than one applications can access to CSE with the same role.

Superuser role may be created with the following associated resources:

- 1) Definition or assignment of CSE-ID name that may be unique in the node hosting the CSE to be instantiated.
- 2) Creation of `<CSEBase>` resource with name equal to CSE-ID.
- 3) Creation of following child resources belonging to a tree with `<CSEBase>` as root:
 - a) `<accessControlPolicy>` child resource enabling full access control for super user's invoked operations to the tree resources. Subsequent created resources may have `accessControlPolicyIDs` attribute addressing this `<accessControlPolicy>` resource.
 - b) `<AE>` child resource to be used as registered AE dedicated to superuser related activities.

Each user role may be created with the following associated resources:

- 1) Definition or assignment of an AE name that may be unique in the CSE.
- 2) Creation of `<AE>` child resource of `<CSEBase>` resource named as described in step 1, to be used as registered application dedicated to user related activities.
- 3) Creation of following child resources belonging to a tree with `<AE>` as root:
 - a) `<accessControlPolicy>` resource enabling partial access control (e.g. these resources cannot be deleted be the user, super user's resources can only be read by user) for user's invoked operations to the tree resources. `<AE>` resource can be updated with `accessControlPolicyIDs` attribute addressing `<accessControlPolicy>` resource.

The above described operations may be executed in the node in order provide the elements and the access control privileges required to provide the initial access to resource operations.

Same user can create more than one `<AE>` resources and other child resource types.

Once user role resource trees have been created the registered AE associated to `<AE>` resource (defined for a user role in step 2) is able to create its own `<container>` resource to store business logic application data that can be shared to other registered AEs in a controlled way acting on its own `<accessControlPolicy>` resource.

Annex F (informative): Interworking/Integration of non-oneM2M solutions and protocols

F.1 Introduction

Non-oneM2M solutions are currently installed and will continue to evolve and to be adopted in future for specific deployments. Some of these solution are the evolution of M2M that have a long history and significant mass installations (e.g. the PLC-related protocols commonly used in building and industrial automation), and are also significantly represented by proprietary solutions, especially in terms of semantic of the data model. The non-oneM2M solutions are potentially used for:

- Legacy deployment: such solutions can make use of both, proprietary or standard protocols; often proprietary data models and functionality are combined with the use of standard protocol.
- New system deployment that privilege the vertical optimization rather the horizontal aspects.
- Area network deployment for which native IP based oneM2M is perceived as not optimized respect to the used technology.

For those non-oneM2M solutions oneM2M needs to provide a means to enable:

- Mixed deployment that are partially oneM2M compliant and partially not, where the oneM2M System provides the solution to integrate multiple technologies (e.g. to add new technologies on top of old installations).
- Hybrid deployment that are still using non-oneM2M protocol (proprietary/standard) and want to use at the same time some of the oneM2M functionalities. A typical case is the exchange of heavy data traffic outside the CSE (e.g. for video surveillance), together with the use of CSE services for control and light traffic exchange.

Behaviour of such non-oneM2M solution is out of scope in present document, but there is some market need to communicate with devices in non-oneM2M domain (so called 'NoDN').

Since NoDN does not have any knowledge about the oneM2M system, AE will take responsibility to bridge those two worlds. We call them Interworking Proxy Entities(IPEs).

This annex provides oneM2M guidance regarding how to implement interworking between the oneM2M solution and external non-oneM2M systems.

F.2 Interworking with non-oneM2M solutions through specialized interworking applications

The solution is based on the use of specialized interworking Application Entities that are interfaced to the CSE via standard Mca reference points.

Such specialized applications are named Inter-working Proxy and are described in figure F.2-1.

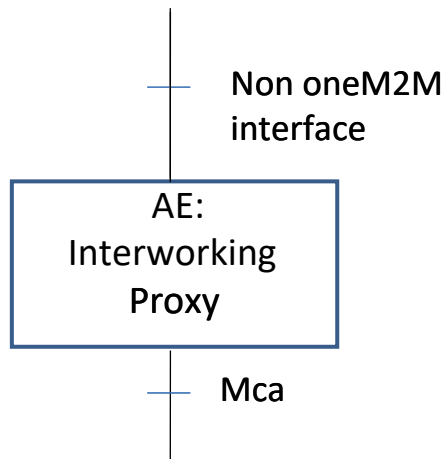

Figure F.2-1: Interworking Proxy

The Inter-working Proxy Application Entity (IPE) is characterized by the support of a non-oneM2M reference point, and by the capability of remapping the related data model to the oneM2M resources exposed via the Mca reference point.

This is typically supported via a full semantic inter-working of the data model used by the non oneM2M and a related protocol inter-working logic, and, depending on the complexity of the non oneM2M data model, can imply the definition of a complex set of resources built via the basic oneM2M ones, or a simple direct mapping of the communication via the containers and its variants (e.g. <container>, <flexContainer>, and <timeSeries>).

The approach enable a unique solution for enabling communications among different protocols, catering for different level of inter-working including protocol inter-working, semantic information exchange, data sharing among the different solution and deployments.

And enables the offering additional values respect to what is today available via existing protocols and proprietary service exposures.

Figure F.2-2 shows the typical scenarios supported by the oneM2M architecture in the context of inter-working. The combination of the different scenarios allows mixed deployments.

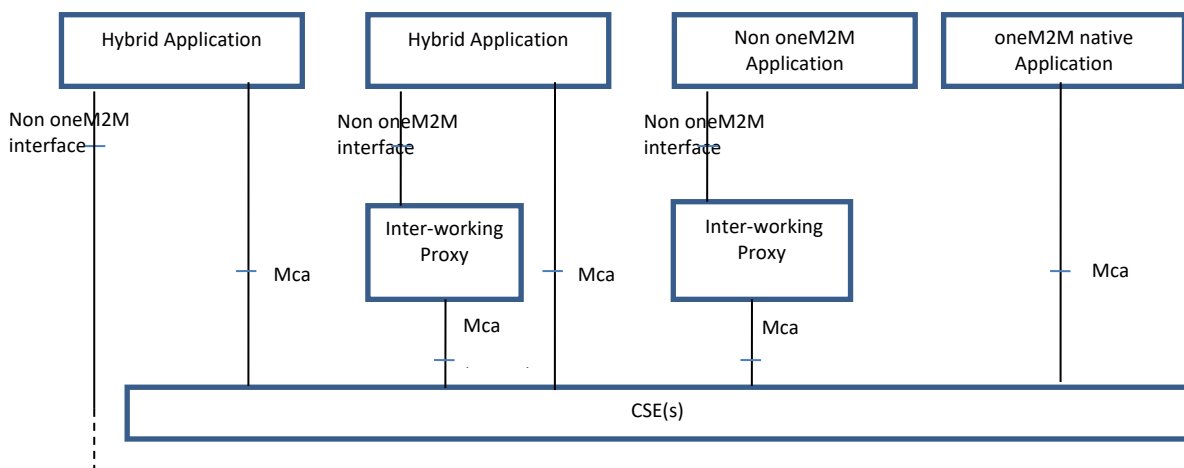

NOTE: The additional option of an inter-working proxy embedded in the CSE as a module with an internal specified interface is under consideration.

Figure F.2-2: Scenarios Supported by oneM2M Architecture

These scenarios are applicable to the CSE with the AE as application dedicated node, in the application Service Node, in the Middle Node and in the infrastructure Node.

The following picture provides an example of the use of such capabilities an area network adopting specific protocols, e.g. Zigbee Telco Profile and Mbus using COSEM Data model.

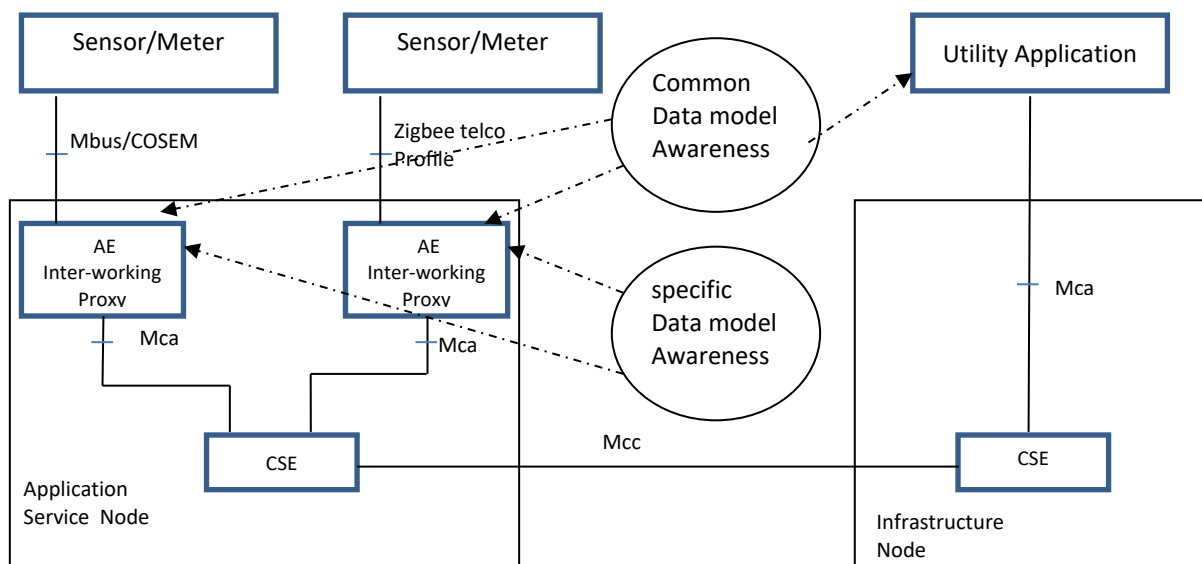

Figure F.2-3: Translation of non-oneM2M Data Model to oneM2M Specific Data Model

There exist three variants of how interworking through an Inter-working Proxy Application Entity over Mca can be supported:

- 1) Interworking with full mapping of the semantic of the non-oneM2M data model to Mca.

This is typically supported via a full semantic inter-working of the data model used by the non-oneM2M solution and the generic data model used in oneM2M (based on usage of containers and its variants) for exchanging application data. The IPE includes the related protocol inter-working logic.

Depending on the complexity of the non-oneM2M data model, this can imply that the Inter-working Proxy Application Entity constructs a complex set of resources (built from the basic oneM2M resources) in the CSE. These resources are oneM2M representations of the non-oneM2M data model and are exposed by the IPE on Mca. They enable CSEs and AEs to access the entities in the non-oneM2M via the IPE.

The benefit of this level of interworking is that it offers a unique solution for enabling communications among different protocols. The data model of the non-oneM2M solution determines its representation (the names, data types and structure of the oneM2M sub resources) in the M2M System. It caters for different levels of inter-working including protocol inter-working, semantic information exchange, data sharing among the different solution and deployments. It enables offering additional values with respect to what is today available via existing protocols and proprietary service exposures.

NOTE: With this level of interworking an M2M Application can access non-oneM2M solutions without the need to know the specific protocol encoding for these solutions. A drawback is that the IPE also potentially needs to interwork between a non-oneM2M security solution and oneM2M security. E.g. it needs to be the termination point of any non-oneM2M specific encryption.

- 2) Interworking using containers for transparent transport of encoded non-oneM2M data and commands via Mca.

In this variant non-oneM2M data and commands are transparently packed by the Inter-working Proxy Application Entity into containers for usage by the CSEs and AEs.

In this case the CSE or AE needs to know the specific protocol encoding rules of the non-oneM2M Solution to be able to en/de-code the content of the containers.

- 3) Interworking using a retargeting mechanism.

This is typically supported via gateway system which is capable to map operations on oneM2M world into non-oneM2M world.

Either CSE or AE provided mapped interface as oneM2M resource structure, and when the operation is executed on the resource structure, the operations will be retargeted to the IPE.

This mapping may be provided for reverse direction, like status change of the non-oneM2M device will be reflected as the UPDATE on the oneM2M container or its variants.

F.3 Interworking versus integration of non-oneM2M solutions

Interworking:

With the approach given above - where specialized interworking applications (IPEs) allow to interact with any non-oneM2M system via the Mca interface - proprietary non-oneM2M solutions as well as non-oneM2M solutions that follow open standards can be interworked with the oneM2M System.

Integration:

When it is desired to make a certain type of non-oneM2M solution (e.g. some type of non-IP based Area Network) a permanent part of the deployed oneM2M Solution then the functionality of the Inter-working Proxy Application Entity can be integrated into the CSE of an Application Node. This is called "Integration" non-oneM2M solutions.

F.4 Entity-relation representation of non-IP based M2M Area Network

F.4.0 Overview

Figure F.4.0-1 provides an entity-relation model that represents a non-IP based M2M area network as well as its relationship to an Interworking Proxy Application Entity (IPE).

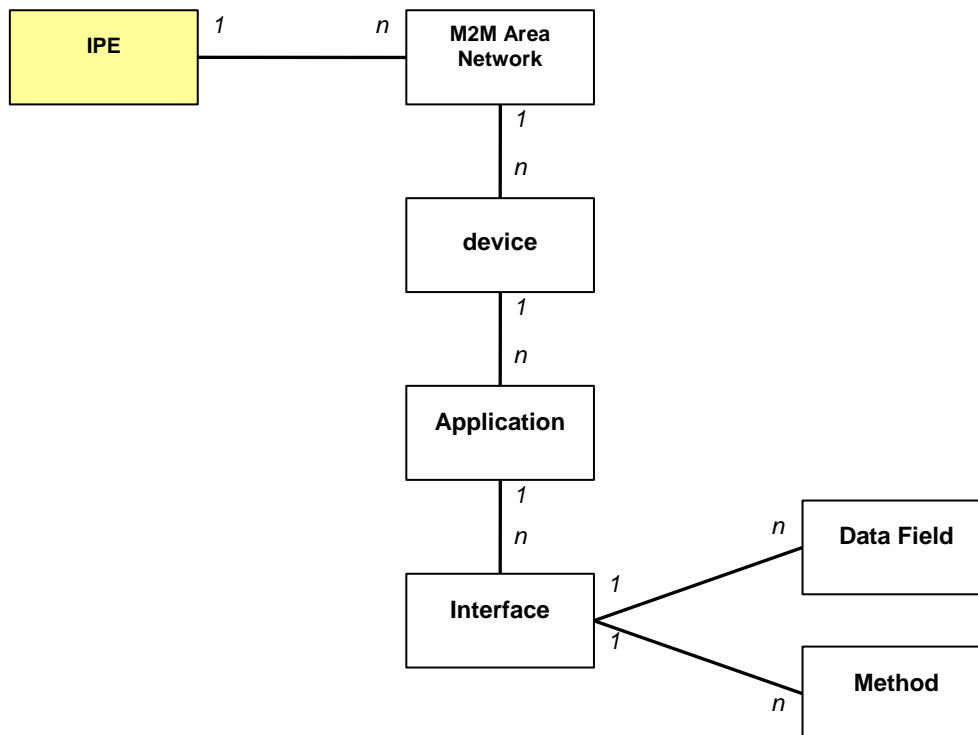

Figure F.4.0-1: Generic entity-relation diagram for an IPE and an M2M Area Network running legacy devices

This entity-relation diagram is e.g. applicable to the following M2M Area Networks:

- ZigBee™.
- DLMS/COSEM.
- Zwave.
- BACnet.
- ANSI C12.
- mBus.

F.4.1 Responsibilities of Interworking Proxy Application Entity (IPE)

More specifically, the IPE is responsible to:

- create oneM2M resources representing the M2M Area Network structure (devices, their applications and interfaces) in the oneM2M Service Capability Layer, accessible via Mca;
- manage the oneM2M resources in case the M2M Area Network structure changes;
- discover the M2M Area Network structure and its changes automatically if this is supported by the technology of the M2M Area Network.

NOTE: Mapping principles of the none-oneM2M information model into oneM2M resources are not specified in this version of the specification.

Annex G:
Void

Annex H (informative): Object Identifier Based M2M Device Identifier

H.1 Overview of Object Identifier

In M2M systems, it is required for devices to be distinguishable from one another through some kind of ID system. In other words, the ID which is allocated to the device is globally unique to ensure the proper operation of M2M systems, such as finding and connecting devices.

In relation to this requirement, the use of Object Identifiers may provide a convenient method to ensure the global uniqueness of M2M devices. The Object Identifier (OID) is an identification mechanism jointly developed by ITU-T and ISO/IEC which can be applied to objects, concepts, and all kinds of tangible or intangible things.

OID uses a hierarchical tree structure and is represented as a sequence of integer values, as shown in figure H.1-1. OID consists of several segments called arcs which provide placeholders for identification and description in the hierarchical tree. The first arc can take the following values:

- itu-t (0);
- iso (1); and
- joint-iso-itu-t (2).

An OID is hierarchically allocated to an entity (e.g. an organization, country, etc.) which has the authority to define lower arcs. For example, ITU-T can manage and allocate lower arcs below itu-t (0), and ISO can allocate lower arcs below iso (1). The general procedure regarding the use of OID is described in Recommendation ITU-T X.660 | ISO/IEC 9834-1 [i.24].

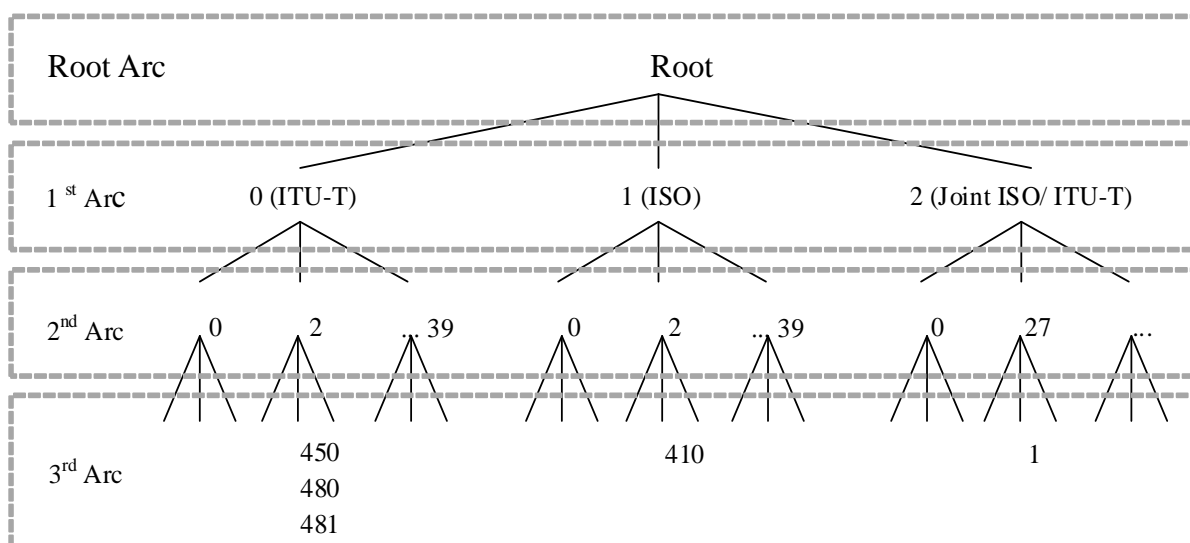

Figure H.1-1: International OID Tree

H.2 OID Based M2M Device Identifier

H.2.0 Overview

An M2M device is identified individually through a globally unique ID system. This clause explains how to allocate a globally unique ID to each M2M device by using the OID scheme. M2M device ID is an example which shows that OID can be applied to any M2M identifiers which need globally unique IDs.

The M2M device ID consists of a higher arc and a sequence of four arcs. It takes the form of {(higher arc) (x) (y) (z) (a)} as illustrated in figure H.2.0-1. The higher arc is defined and managed according to the OID procedure. Each arc in the remaining sequence of four arcs represents the manufacturer ID, product model ID, serial number ID, and expanded ID, respectively.

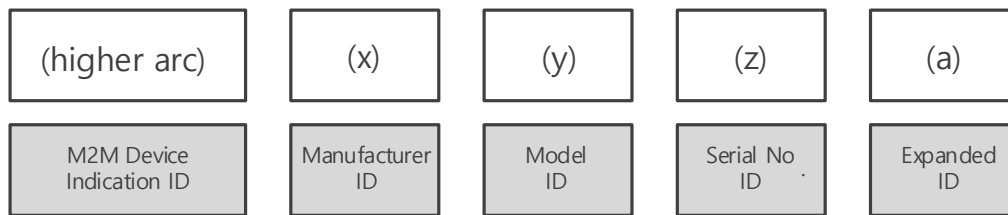

Figure H.2.0-1: M2M Device ID

H.2.1 M2M Device Indication ID - (higher arc)

The M2M Device Indication ID (higher arc) represents a globally unique identifier for the M2M device. The composition of the higher arc is variable and may be composed of several sub-arcs. The highest arc is assigned and managed by ITU-T or ISO.

H.2.2 Manufacturer ID - (x)

The 1st arc (x) among the sequential 4 arcs is used to identify the manufacturer which produces the M2M device. The first arc (x) is managed and allocated by the authority related with (higher arc).

H.2.3 Model ID - (y)

The 2nd arc (y) among the sequential 4 arcs identifies the device model produced by the manufacturer x. The second arc is managed and allocated by the manufacturer represented by the (x) arc.

H.2.4 Serial Number ID - (z)

The 3rd arc (z) among the sequential 4 arcs is for identifying the serial number of the device model y. The third arc is managed and allocated by the manufacturer represented by the (x) arc.

H.2.5 Expanded ID - (a)

The 4th arc (a) among the sequential 4 arcs is for identifying the legacy device which operates under the M2M device. The 4th arc for Expanded ID is allocated by the M2M device by adding a 4th arc to its device ID {(higher arc) (x) (y) (z)}. Therefore, the ID of legacy device which operates under the M2M device takes the form of {(higher arc) (x) (y) (z) (a)}. The fourth arc is managed and allocated by the M2M device.

H.3 Example of M2M device ID based on OID

Let us assume an M2M Device ID of {0 2 481 1 100 3030 10011}. The M2M device ID can be interpreted as follows:

- (0 2 481 1) in {0 2 481 1 100 3030 10011} - represents the M2M Device Indication ID (higher arc):
 - (0) in {0 2 481 1 100 3030 10011} - identifies the managing organization ITU-T.
 - (2) in {0 2 481 1 100 3030 10011} - identifies "Administration".
 - (481) in {0 2 481 1 100 3030 10011} - identifies the data country code for Korea.
 - (1) in {0 2 481 1 100 3030 10011} - identifies an M2M device.
- (100) in {0 2 481 1 100 3030 10011} - identifies the device Manufacturer.
- (3030) in {0 2 481 1 100 3030 10011} - identifies the device Model.
- (10011) in {0 2 481 1 100 3030 10011} - identifies the device Serial number.

Annex I (informative): Resource addressing examples

I.1 Example resource tree

In this annex, a set of resources organized according to the resource tree depicted in Figure I.1-1 is assumed. The depicted resources are assumed to be hosted on a CSE with SP-relative-CSE-ID equal to "/IN-CSE-0001". Furthermore, the M2M-SP-ID is assumed to be "//m2m.service.com".

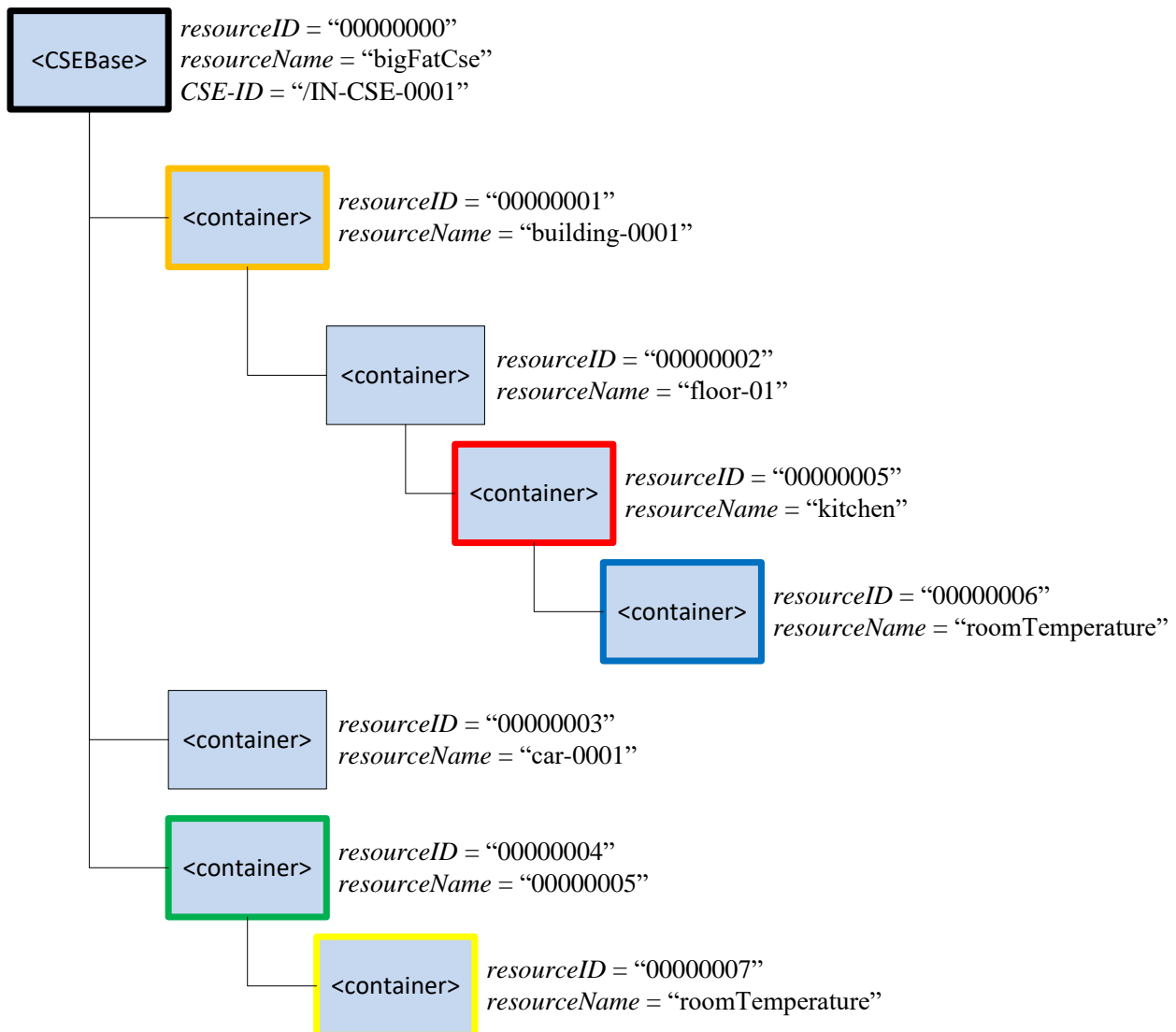

Figure I.1-1

I.2 Valid resource IDs

<container>

Table I.2-1: Addressing (resourceId="00000004", resourceName="00000005")

Scope	Method	
	<i>Non-Hierarchical</i>	<i>Hierarchical</i>
CSE-Relative	00000004	-/00000005 bigFatCse/00000005 00000000/00000005
SP-Relative	/IN-CSE-0001/00000004	/IN-CSE-0001/-/00000005 /IN-CSE-0001/bigFatCse/00000005 /IN-CSE-0001/00000000/00000005
Absolute	//m2m.service.com/IN-CSE-0001/00000004	//m2m.service.com /IN-CSE-0001/-/00000005 //m2m.service.com /IN-CSE-0001/bigFatCse/00000005 //m2m.service.com/IN-CSE-0001/00000000/00000005

<container>

Table I.2-2 Addressing (resourceId="00000007", resourceName="roomTemperature")

Scope	Method	
	<i>Non-Hierarchical</i>	<i>Hierarchical</i>
CSE-Relative	00000007	-/00000005/roomTemperature bigFatCse/00000005/roomTemperature 00000000/00000005/roomTemperature 00000004/roomTemperature
SP-Relative	/IN-CSE-0001/00000007	/IN-CSE-0001/-/00000005/roomTemperature /IN-CSE-0001/bigFatCse/00000005/roomTemperature /IN-CSE-0001/00000000/00000005/roomTemperature /IN-CSE-0001/00000004/roomTemperature
Absolute	//m2m.service.com/IN-CSE-0001/00000007	//m2m.service.com/IN-CSE-0001/-/00000005/roomTemperature //m2m.service.com/IN-CSE-0001/bigFatCse/00000005/roomTemperature //m2m.service.com/IN-CSE-0001/00000000/00000005/roomTemperature //m2m.service.com/IN-CSE-0001/00000004/roomTemperature

<container>

Table I.2-3 Addressing (resourceId="00000006", resourceName="roomTemperature")

Scope	Method	
	Non-Hierarchical	Hierarchical
CSE-Relative	00000006	 -/building-0001/floor-01/kitchen/roomTemperature bigFatCse/building-0001/floor-01/kitchen/roomTemperature 00000000/building-0001/floor-01/kitchen/roomTemperature 00000001/floor-01/kitchen/roomTemperature 00000002/kitchen/roomTemperature 00000005/roomTemperature
SP-Relative	/IN-CSE-0001/00000006	 /IN-CSE-0001-/building-0001/floor-01/kitchen/roomTemperature /IN-CSE-0001/bigFatCse/building-0001/floor-01/kitchen/roomTemperature /IN-CSE-0001/00000000/building-0001/floor-01/kitchen/roomTemperature /IN-CSE-0001/00000001/floor-01/kitchen/roomTemperature /IN-CSE-0001/00000002/kitchen/roomTemperature /IN-CSE-0001/00000005/roomTemperature
Absolute	//m2m.service.com/IN-CSE-0001/00000006	 //m2m.service.com/IN-CSE-0001-/building-0001/floor-01/kitchen/roomTemperature //m2m.service.com/IN-CSE-0001/bigFatCse/building-0001/floor-01/kitchen/roomTemperature //m2m.service.com/IN-CSE-0001/00000000/building-0001/floor-01/kitchen/roomTemperature //m2m.service.com/IN-CSE-0001/00000001/floor-01/kitchen/roomTemperature //m2m.service.com/IN-CSE-0001/00000002/kitchen/roomTemperature //m2m.service.com/IN-CSE-0001/00000005/roomTemperature

<container>

Table I.2-4 Addressing (resourceId="00000005", resourceName="kitchen")

Scope	Method	
	Non-Hierarchical	Hierarchical
CSE-Relative	00000005	-/building-0001/floor-01/kitchen bigFatCse/building-0001/floor-01/kitchen 00000000/building-0001/floor-01/kitchen 00000001/floor-01/kitchen 00000002/kitchen
SP-Relative	/IN-CSE-0001/00000005	/IN-CSE-0001/-/building-0001/floor-01/kitchen /IN-CSE-0001/bigFatCse/building-0001/floor-01/kitchen /IN-CSE-0001/00000000/building-0001/floor-01/kitchen /IN-CSE-0001/00000001/floor-01/kitchen /IN-CSE-0001/00000002/kitchen
Absolute	//m2m.service.com/IN-CSE-0001/00000005	//m2m.service.com/IN-CSE-0001/-/building-0001/floor-01/kitchen //m2m.service.com/IN-CSE-0001/bigFatCse/building-0001/floor-01/kitchen //m2m.service.com/IN-CSE-0001/00000000/building-0001/floor-01/kitchen //m2m.service.com/IN-CSE-0001/00000001/floor-01/kitchen //m2m.service.com/IN-CSE-0001/00000002/kitchen

<container>

Table I.2-5 Addressing (resourceId="00000001", resourceName="building-0001")

Scope	Method	
	Non-Hierarchical	Hierarchical
CSE-Relative	00000005	-/building-0001 bigFatCse/building-0001 00000000/building-0001
SP-Relative	/IN-CSE-0001/00000005	/IN-CSE-0001/-/building-0001 /IN-CSE-0001/bigFatCse/building-0001 /IN-CSE-0001/00000000/building-0001
Absolute	//m2m.service.com/IN-CSE-0001/00000005	//m2m.service.com/IN-CSE-0001/-/building-0001 //m2m.service.com/IN-CSE-0001/bigFatCse/building-0001 //m2m.service.com/IN-CSE-0001/00000000/building-0001

<CSEBase>

Table I.2-6 Addressing (resourceId="IN-CSE-0001", resourceName="bigFatCse")

Scope	Method	
	<i>Non-Hierarchical</i>	<i>Hierarchical</i>
CSE-Relative	bigFatCse 00000000	N/A
SP-Relative	/IN-CSE-0001/- /IN-CSE-0001/bigFatCse /IN-CSE-0001/00000000	N/A
Absolute	//m2m.service.com/IN-CSE-0001/- //m2m.service.com/IN-CSE-0001/bigFatCse //m2m.service.com /IN-CSE-0001/00000000	N/A

Annex J (informative): Bibliography

- IETF RFC 6874: "Representing IPV6 Zone Identifiers in Address Literals and Uniform Resources Identifiers".

Annex K (normative): Syntaxes for content based discovery of <contentInstance>

K.1 Introduction

This annex specifies the syntax for contentFilterQuery filterCriteria (see clause 8.1.2).

The syntax of string for contentFilterQuery parameter shall be chosen by contentFilterSyntax parameter.

K.2 'jsonpath' query syntax

This syntax of query is applicable in the case of stored data in the <contentInstance> resource which is indicated as JSON based according to the *contentInfo* attribute value.

The target of evaluation shall be located by JSON path like addressing, which is constructed following rules:

- The entire data shall be referred by '\$(dollar sign)' character.
- The notation '[n]' shall refer n-th member of JSON Array.
- The operator '.(dot)' followed by name shall refer member of JSON Objects.
- The name shall be surrounded with ""(quote)' characters when the name contains special characters, such as '\$', ':', ' (space)', '[', ']', '{', and '}'.
- The ' (space)' character shall be inserted between reserved keyword and other component of query string.

The following keywords shall be used to construct query string when *contentFilterSyntax* parameter was 'JSON-path'.

Table K.2-1: Reserved keywords for JSON-Path query syntax

Keyword	Condition	Applicability
EQ (Equals)	When the target value equals with query	String or number
NE (Not Equals)	When the target value does not equal with query.	String or number
GT (Greater Than)	When the target value was greater than number given as query.	Number only
LT (Less Than)	When the target value was less than number given as query.	Number only
GE (Greater or Equals)	When the targeted value was greater or equals with number given as query.	Number only
LE (Less or Equals)	When the targeted value was less or equals with number given as query.	Number only
MATCH	When the targeted value contains given string.	String only
AND	Concatenation of query which evaluated as AND combination logic.	Query-string
OR	Concatenation of query-string which evaluated as OR combination logic.	Query-string

History

Publication history		
V1.6.1	30-Jan-2015	Release 1 - Publication
V1.13.1	29-Feb-2016	Update to Release 1 - Publication
V2.10.0	30-Aug-2016	Release 2 - Publication
V2.18.1	12-Mar-2018	Release 2A - Publication