

TR-M2M-0007v0.11.0

Study of Abstraction and Semantics
Enablenents

2014 年 11 月 10 日制定

一般社団法人

情報通信技術委員会

THE TELECOMMUNICATION TECHNOLOGY COMMITTEE

本書は、一般社団法人情報通信技術委員会が著作権を保有しています。
内容の一部または全部を一般社団法人情報通信技術委員会の許諾を得ることなく複製、
転載、改変、転用及びネットワーク上での送信、配布を行うことを禁止します。

Study of Abstraction and Semantics Enablements

<参考> [Remarks]

1. 国際勧告等の関連 [Relationship with international recommendations and standards]

本技術レポートは、oneM2M で作成された Technical Report 0007v0.11.0 に準拠している。

[This Technical Report is transposed based on the Technical Report 0007v0.11.0 developed by oneM2M.]

2. 作成専門委員会 [Working Group]

oneM2M 専門委員会 [oneM2M Working Group]



ONEM2M TECHNICAL REPORT

Document Number	oneM2M-TR-0007- Study_of_Abstraction_and_Semantics_Enablements -v-0.11.0
Document Name:	Study of Existing Abstraction & Semantic Capability Enablement Technologies for consideration by oneM2M
Date:	2014-August-01
Abstract:	<p>Collect and study the state-of-the-art technologies that may be leveraged by oneM2M to enable its abstraction & semantics capability. This includes a collection of terminology and use cases considered by other standardization or industrial fora working on ontologies, semantics and abstraction, as well as relevant source material proposed by Partner Types 1 for transfer to oneM2M and contributions from Partner Types 2.</p> <p>Evaluate the possibility of leveraging all or part of those technologies and/or solutions by oneM2M architecture and protocols to enable its abstraction & semantics capability.</p>

This Specification is provided for future development work within oneM2M only. The Partners accept no liability for any use of this Specification.

The present document has not been subject to any approval process by the oneM2M Partners Type 1. Published oneM2M specifications and reports for implementation should be obtained via the oneM2M Partners' Publications Offices.

About oneM2M

The purpose and goal of oneM2M is to develop technical specifications which address the need for a common M2M Service Layer that can be readily embedded within various hardware and software, and relied upon to connect the myriad of devices in the field with M2M application servers worldwide.

More information about oneM2M may be found at: <http://www.oneM2M.org>

Copyright Notification

No part of this document may be reproduced, in an electronic retrieval system or otherwise, except as authorized by written permission.

The copyright and the foregoing restriction extend to reproduction in all media.

© 2013, oneM2M Partners Type 1 (ARIB, ATIS, CCSA, ETSI, TIA, TTA, TTC).

All rights reserved.

Notice of Disclaimer & Limitation of Liability

The information provided in this document is directed solely to professionals who have the appropriate degree of experience to understand and interpret its contents in accordance with generally accepted engineering or other professional standards and applicable regulations. No recommendation as to products or vendors is made or should be implied.

NO REPRESENTATION OR WARRANTY IS MADE THAT THE INFORMATION IS TECHNICALLY ACCURATE OR SUFFICIENT OR CONFORMS TO ANY STATUTE, GOVERNMENTAL RULE OR REGULATION, AND FURTHER, NO REPRESENTATION OR WARRANTY IS MADE OF MERCHANTABILITY OR FITNESS FOR ANY PARTICULAR PURPOSE OR AGAINST INFRINGEMENT OF INTELLECTUAL PROPERTY RIGHTS. NO oneM2M PARTNER TYPE 1 SHALL BE LIABLE, BEYOND THE AMOUNT OF ANY SUM RECEIVED IN PAYMENT BY THAT PARTNER FOR THIS DOCUMENT, WITH RESPECT TO ANY CLAIM, AND IN NO EVENT SHALL oneM2M BE LIABLE FOR LOST PROFITS OR OTHER INCIDENTAL OR CONSEQUENTIAL DAMAGES. oneM2M EXPRESSLY ADVISES ANY AND ALL USE OF OR RELIANCE UPON THIS INFORMATION PROVIDED IN THIS DOCUMENT IS AT THE RISK OF THE USER.

Contents

Contents	3
1 Scope.....	7
2 References	7
2.1 Normative references	7
2.2 Informative references.....	7
3 Definitions, symbols, abbreviations and acronyms.....	9
3.1 Definitions.....	9
3.2 Symbols.....	9
3.3 Abbreviations.....	9
3.4 Acronyms	10
4 Conventions.....	10
5 Introduction on Abstraction and Semantic Capability Enablement in oneM2M.....	10
5.1 Overview	10
5.1.1 Motivation for Abstraction and Semantics.....	10
5.1.2 Basic Concept of Semantics	11
5.2 Use Cases Analysis	12
5.3 Benefits of Abstraction and Semantics.....	14
6 Abstraction Technologies.....	14
6.1 Overview	14
6.1.1 Basics about Interworking and Abstraction.....	14
6.1.2 Information models for Interworking.....	15
6.1.2.1 Mapping Information Models into oneM2M Resources:.....	17
6.1.2.1 Proposal:.....	18
6.1.3 Abstraction and Semantics	18
6.1.3.1 Proposal:.....	19
6.2 Introduction of Existing Technologies	19
6.2.1 Introduction to ETSI M2M Device Abstraction	20
6.2.1.1 Architecture	20
6.2.1.2 Interworking with legacy devices (d) through abstract devices.....	20
6.2.1.3 Gateway Resource Abstraction (GRA) Capability.....	21
6.2.1.4 Subscription of Abstract Resources.....	22
6.2.1.5 Mapping Principle.....	22
6.2.2 Introduction to Home Gateway Device Abstraction Concept.....	25
6.2.2.1 Architecture	25
6.3 Specific requirements for abstraction.....	27
7 Technologies for Semantic M2M System.....	27
7.1 Overview	27
7.1.1 Introduction to Semantics technologies	27
7.1.2 Key functionalities for Semantics.....	28
7.1.2.1 Semantic Analysis and Query	29
7.1.2.2 Reasoning	29
7.1.2.3 Ontology Repository	29
7.1.2.4 Ontology Modelling and Processing	30
7.1.2.5 Semantic Mash-up.....	30
7.1.2.6 Semantic Annotation	30
7.1.2.7 Semantics Repository	30
7.1.2.8 Device Abstraction.....	30
7.1.2.9 Data Repository.....	30
7.1.2.10 M2M Data Collection.....	31
7.2 Introduction of Existing Technologies	31
7.2.1 Introduction to ETSI Semantic M2M System	31
7.2.1.1 System Overview	31
7.2.1.2 Semantic Annotation	31

7.2.1.3	Semantic Mashups for Virtual Things	33
7.2.2	Introduction to OGC Sensor Web Enablement.....	35
7.2.2.1	Overview	35
7.2.2.2	Sensor Web Enablement (SWE) Languages	35
7.2.2.3	Semantic annotations in OGC standards.....	37
7.2.3	Introduction to W3C Semantic Sensor Network Ontology	39
7.2.3.1	Overview	39
7.2.3.2	The Semantic Sensor Network Ontology.....	40
7.3	Key Issues on Standardising Semantics and Ontologies	44
7.3.1	How to share common understanding of the structure of information among m2m nodes?.....	44
7.3.2	How to enable the reuse of domain knowledge?	44
7.3.3	How to enable evolving ontologies?.....	45
7.3.4	How to analyse domain knowledge (ontologies)?	45
7.3.5	How to make semantic annotations?.....	45
7.3.6	How to generate (or register) new M2M resources/applications based on existing M2M resources/applications?	45
7.3.6	How make reasoning?.....	45
7.3.7	How to enable semantic rule ?.....	46
7.4	Specific potential requirements for semantics	47
7.4.1	Semantics Related Requirements.....	47
7.4.1.2	Ontology Requirements for Semantics Support	47
8	Support for Abstraction and Semantics in oneM2M.....	47
8.1	Summary of Requirements	47
8.2	Modeling aspects for abstraction and semantics in oneM2M	48
8.2.1	Overview of modelling aspects	48
8.2.2	Modelling of Devices and Things.....	49
8.2.2.1	Modelling of Concepts	49
8.2.2.2	Modelling of Types	50
8.2.2.3	Modelling of Instances	52
8.2.2.3	Combined view of approach	53
8.2.2.4	Modelling of Associations	54
8.2.3	Device and Device Template Modelling Using Ontologies	56
8.3	oneM2M architectural considerations for abstraction and semantics.....	60
8.3.1	Introduction.....	60
8.3.2	Semantic Annotations	60
8.3.3	Use of Semantic Technologies for Platform Functionalities	61
8.3.4	Full Semantic Platform	62
8.4	Interworking with non oneM2M Devices and Area Networks in Rel-1	63
8.4.1	Semantic support in oneM2M Release 1.....	63
8.4.2	Basic functional principles	63
8.4.3	Generic topology for interworking with non-oneM2M devices and Area Networks	64
8.4.4	Semantic modelling of interworking.....	65
8.4.5	Mapping into oneM2M resources.....	66
8.4.5.1	Interworking Proxy Application Entity	67
8.4.5.1.1	Linking the Interworking Proxy Application Entity to its M2M Area Networks.....	68
8.4.5.2	M2M Area Network Application:	68
8.4.5.2.1	Linking the M2M Area Network to its non-oneM2M devices.....	70
8.4.5.2.2	Parameters of the M2M Area Network	70
8.4.5.2.3	Functional description of the M2M Area Network Application:	71
8.4.5.3	Non-oneM2M Device Application:.....	71
8.4.5.3.1	Linking the non-oneM2M device to its Function blocks.....	71
8.4.5.3.2	Parameters of the Non-oneM2M Device Application	72
8.4.5.3.3	Functional description of the Non-oneM2M Device Application:	73
8.4.5.4	Function Block Application:.....	73
8.4.5.4.1	Linking the Function block to its Interfaces	73
8.4.5.4.2	Parameters of the Function Block Application	74
8.4.5.4.3	Functional description of the Function Block Application:	75
8.4.5.5	Interface container:.....	75
8.4.5.5.1	Linking the Interface to its Data Fields	77
8.4.5.5.2	Linking the Interface to its Methods	77
8.4.5.5.3	Parameters of the Interface	78

8.4.5.5.4	Methods of the Interface.....	78
9	Conclusions	79
	<i>Proforma copyright release text block</i>	80
	<i>Annexes</i>	80
	Annex A: Use Cases (informative)	81
A.1	An example of Home Environment Monitoring Service using semantic mash-up.....	81
A.1.1	Description	81
A.1.2	Source (as applicable)	81
A.1.3	Actors.....	82
A.1.4	Pre-conditions.....	82
A.1.5	Triggers (if any).....	82
A.1.6	Normal Flow (as applicable)	82
A.1.7	Post-conditions (if any)	84
A.1.8	High Level Illustration (as applicable).....	84
A.2	Semantic Home Control	85
A.2.1	Description	85
A.2.1	Source	89
A.3	Gym Use Case	90
A.3.1	Description	90
A.3.2	Source	92
A.3.3	Actors.....	92
A.3.4	Pre-conditions.....	92
A.3.5	Triggers.....	93
A.3.6	Normal Flow	93
A.3.7	Post-conditions	94
A.3.8	High Level Illustration	95
A.3.9	Potential requirements	95
A.4	Intelligent Alarm Service using Semantic Discovery and Mash-up	96
A.4.1	Description	96
A.4.2	Source	98
A.4.3	Actors.....	99
A.4.4	Pre-conditions (if any)	99
A.4.5	Triggers.....	99
A.4.7	Post-conditions (if any).....	101
A.4.8	High Level Illustration (as applicable).....	101
A.4.9	Potential requirements (as applicable)	101
A.5	Semantic Home Automation Control	101
A.5.1	Description	101
A.5.2	Source	102
A.5.3	Actors.....	102
A.5.4	Pre-conditions.....	102
A.5.5	Triggers.....	103
A.5.6	Normal Flow	103
A.5.7	Post-conditions	103
A.5.8	High Level Illustration.....	103
A.5.9	Potential requirements	105
A.6	Semantic smart building light control	106
A.6.1	Description	106
A.6.2	Source	109
A.6.3	Actors.....	109
A.6.4	Pre-conditions.....	109
A.6.5	Triggers.....	109
A.6.6	Normal Flow	109
A.6.7	Post-conditions	111
A.6.8	High Level Illustration	112
A.6.9	Potential requirements	112
A.7	Smart Home load control use case	112
A.7.1	Description	112
A.7.2	Source	113

A.7.3	Actors.....	113
A.7.4	Pre-conditions.....	114
A.7.5	Triggers.....	114
A.7.6	Normal Flow	114
A.7.7	Post-conditions.....	114
A.7.8	High Level Illustration.....	114
A.7.9	Potential requirements	114
Annex <y>: Bibliography		115
History		115

1 Scope

The present document describes and collects the state-of-art of the existing technologies on abstraction & semantics capability, evaluates if the technologies can match the requirements defined in oneM2M, analyzes how the technologies can leverage the design of the architecture of oneM2M.

2 References

References are either specific (identified by date of publication and/or edition number or version number) or non-specific. For specific references, only the cited version applies. For non-specific references, the latest version of the referenced document (including any amendments) applies.

2.1 Normative references

As a Technical Report (TR) is entirely informative it shall not list normative references.

The following referenced documents are necessary for the application of the present document.

Not applicable.

2.2 Informative references

The following referenced documents are not necessary for the application of the present document but they assist the user with regard to a particular subject area.

- [i.1] ETSI TS 102 690: "Machine-to-Machine communication (M2M): Functional architecture".
- [i.2] ETSI TR 101 584: "Machine-to-Machine communication (M2M): Study on Semantic support for M2M Data".
- [i.3] Open Geospatial Consortium, <http://www.opengeospatial.org/>.
- [i.4] Open Geospatial Consortium, Sensor Web Enablement DWG, <http://www.opengeospatial.org/projects/groups/sensorwebdwg>.
- [i.5] Open Geospatial Consortium, Sensor Web Enablement architecture, August 2008.
- [i.6] Open Geospatial Consortium, Observations and Measurements, Available at <http://www.opengeospatial.org/standards/om>.
- [i.7] Open Geospatial Consortium, OpenGIS Sensor Model Language (SensorML), Available at <http://www.opengeospatial.org/standards/sensorml>.
- [i.8] Open Geospatial Consortium, OpenGIS Transducer Markup Language (TML) Encoding Specification, Available at <http://www.opengeospatial.org/standards/tml>.
- [i.9] Open Geospatial Consortium, Sensor Observation Service, Available at <http://www.opengeospatial.org/standards/sos>.
- [i.10] Open Geospatial Consortium, Sensor Planning Service (SPS), Available at <http://www.opengeospatial.org/standards/sps>.
- [i.11] Open Geospatial Consortium, Sensor Alert Service, Available at <http://www.opengeospatial.org/standards/requests/44>.
- [i.12] W3C Semantic Sensor Network Incubator Group, http://www.w3.org/2005/Incubator/ssn/wiki/Main_Page.

- [i.13] Open Geospatial Consortium, Sensor Web Interface for IoT SWG, <http://www.opengeospatial.org/projects/groups/sweiotswg>.
- [i.14] Open Geospatial Consortium Best Practice, Semantic annotations in OGC standards, Available at <http://www.opengeospatial.org/node/1790>.
- [i.15] Open Geospatial Consortium, Geography Markup Language, Available at <http://www.opengeospatial.org/standards/gml>.
- [i.16] W3C Semantic Sensor Network Incubator Group, http://www.w3.org/2005/Incubator/ssn/wiki/Main_Page.
- [i.17] Semantic Sensor Network XG Final Report, W3C Incubator Group Report 28 June 2011, <http://www.w3.org/2005/Incubator/ssn/XGR-ssn/>.
- [i.18] Open Geospatial Consortium, OpenGIS Sensor Model Language (SensorML), Available at <http://www.opengeospatial.org/standards/sensorml>.
- [i.19] Open Geospatial Consortium, <http://www.opengeospatial.org/>.
- [i.20] Open Geospatial Consortium, Sensor Web Enablement DWG, <http://www.opengeospatial.org/projects/groups/sensorwebdwg>.
- [i.21] SSN Suggested Key Ontology Intro Attributes, Available at http://www.w3.org/2005/Incubator/ssn/wiki/SSN_Suggested_Key_Ontology_Intro_Attributes.
- [i.22] W3C Semantic Sensor Network Incubator Group, Semantic Sensor Network Ontology, Available at <http://www.w3.org/2005/Incubator/ssn/ssnx/ssn>.
- [i.23] W3C Semantic Sensor Network Incubator Group, Semantic Sensor Network Ontology, Available at <http://www.w3.org/2005/Incubator/ssn/wiki/SSN>.
- [i.24] DUL ssn, http://www.w3.org/2005/Incubator/ssn/wiki/DUL_ssn.
- [i.25] HGI02029: "Smart Home Architecture and System Requirements".
- [i.26] W3C OWL Working Group, OWL 2 Web Ontology Language Document Overview, Available at <http://www.w3.org/TR/owl2-overview/>
- [i.27] W3C SPARQL Working Group, SPARQL 1.1 Overview, Available at <http://www.w3.org/TR/sparql11-overview/>
- [i.28] Jack Rusher, TripleStore, Semantic Web Advanced Development for Europe (SWAD-Europe), Workshop on Semantic Web Storage and Retrieval - Position Papers, Available at <http://www.w3.org/2001/sw/Europe/events/20031113-storage/positions/rusher.html>
- [i.29] oneM2M-TR-0001-UseCase: "oneM2M Use cases collection"
- [i.30] Resource Description Framework (RDF): Concepts and Abstract Syntax (<http://www.w3.org/TR/rdf-concepts/>)
- [i.31] RDF Vocabulary Description Language 1.0: RDF Schema, <http://www.w3.org/TR/rdf-schema/>
- [i.32] SPARQL Query Language for RDF, <http://www.w3.org/TR/rdf-sparql-query/>
- [i.33] Web Ontology Language (OWL), <http://www.w3.org/2001/sw/wiki/OWL>
- [i.34] Open Geospatial Consortium, OpenGIS Sensor Model Language (SensorML), <http://www.opengeospatial.org/standards/sensorml> .
- [i.35] Dbpedia, <http://dbpedia.org/About>
- [i.36] Turtle: Terse RDF Triple Language. Eric Prud'hommeaux and Gavin Carothers. W3C Last Call Working Draft, 10 July 2012, <http://www.w3.org/TR/2012/WD-turtle-20120710/>. Latest version available at <http://www.w3.org/TR/turtle/>
- [i.37] OWL Syntaxes, <http://ontogenesis.knowledgeblog.org/88?kblog-transclude=2>

- [i.38] Rule Interchange Format (RIF) overview (second version), available at <http://www.w3.org/TR/2013/NOTE-rif-overview-20130205/>
- [i.39] SWRL: A Semantic Web Rule Language Combining OWL and RuleML (Version 0.5), available at <http://www.daml.org/2003/11/swrl/>
- [i.40] SPIN - Overview and Motivation, available at <http://www.w3.org/Submission/spin-overview/>

3 Definitions, symbols, abbreviations and acronyms

3.1 Definitions

Abstraction: The process of mapping between a set of Device Application Information Models and an Abstract Application Information Model according to a specified set of rules.

Attribute: (also called “property”, “characteristics”, “characteristics”)
Example: Name, Time, Location

Ontology : An ontology is a formal specification of a conceptualization, that is defining Concepts as Objects with their properties and relationships versus other Concepts.

Physical entity: a tangible element that is intrinsic to the environment, and that is not specific to a particular M2M application in this environment.

Depending on the environment, the physical entity may be an appliance, a piece of furniture, somebody, a room of a building, a car, a street of a city, etc. To be part of the M2M/IoT architecture, a physical entity does not need to be connected through a direct network interface, or even to be identified through a universal identification scheme such as RFID/EPC global, provided it can be sensed by sensors that are supposed to be deployed in this environment, and possibly acted upon by actuators.

Relation : (also called “interrelation”) stating a relationship among Concepts
Example: “is-part-of”, “is-subtype-of”

Thing: an element of the environment that is individually identifiable in the M2M system.

Thing Representation: It is the instance of the informational model of the Thing in the M2M System. A Thing Representation provides means for applications to interact with the Thing.

3.2 Symbols

Clause numbering depends on applicability.

For the purposes of the present document, the [following] symbols [given in ... and the following] apply:

Symbol format

<symbol>	<Explanation>
<2 nd symbol>	<2 nd Explanation>
<3 rd symbol>	<3 rd Explanation>

3.3 Abbreviations

Abbreviations should be ordered alphabetically.

Clause numbering depends on applicability.

For the purposes of the present document, the [following] abbreviations [given in ... and the following] apply:

Abbreviation format

<ABBREVIATION1> <Explanation>
<ABBREVIATION2> <Explanation>
<ABBREVIATION3> <Explanation>

3.4 Acronyms

Acronyms should be ordered alphabetically.

Clause numbering depends on applicability.

For the purposes of the present document, the [following] abbreviations [given in ... and the following] apply:

Acronym format

<ACRONYM1> <Explanation>
<ACRONYM2> <Explanation>
<ACRONYM3> <Explanation>

4 Conventions

The key words "MUST", "MUST NOT", "REQUIRED", "SHALL", "SHALL NOT", "SHOULD", "SHOULD NOT", "RECOMMENDED", "MAY", and "OPTIONAL" in this document are to be interpreted as described in RFC 2119 [**Error! Reference source not found.**].

5 Introduction on Abstraction and Semantic Capability Enablement in oneM2M

5.1 Overview

5.1.1 Motivation for Abstraction and Semantics

While M2M systems benefit from the variety of existing connectivity technologies to make any M2M Service work in almost any environment, M2M Applications developers don't expect to get into deep knowledge of each of these technologies for developing their applications. The abstraction of the technologies aims at hiding the complexity of the specific technologies by providing a single format to represent devices and unified methods directly usable by the applications.

Through Abstraction means, a M2M System decouples M2M applications from specific end device implementations – e.g. allows Home control Service to access a 'switch', whatever specific technology is used by the switch (be it KNX, or ZigBee, or DECT-ULE, or ...) because the 'switch' interface is abstracted from any specific technology.

Going further in simplifying the life of the Application developer and of the end-user, Semantics approach consists in getting information on the 'meaning' of M2M data. Semantic mechanisms enable an application to find suitable M2M data / devices and use them (if permitted), and encourage the creation of an open market for M2M data. Moreover, Semantic is essential if the M2M System is expected to interact with real world entities ("things") since a key role of Semantic is to provide a description of the relationship between things / data / information.

The semantics of specific M2M data can be provided by the industry segment that uses these data. This is the reason why oneM2M expects a lot of synergy with vertical domain industries when analysing possible solutions to provide Semantic support to M2M applications data thanks to their semantic description.

Figure 1 is an illustrated example of what is meant by both Abstraction and Semantics in this oneM2M TR.

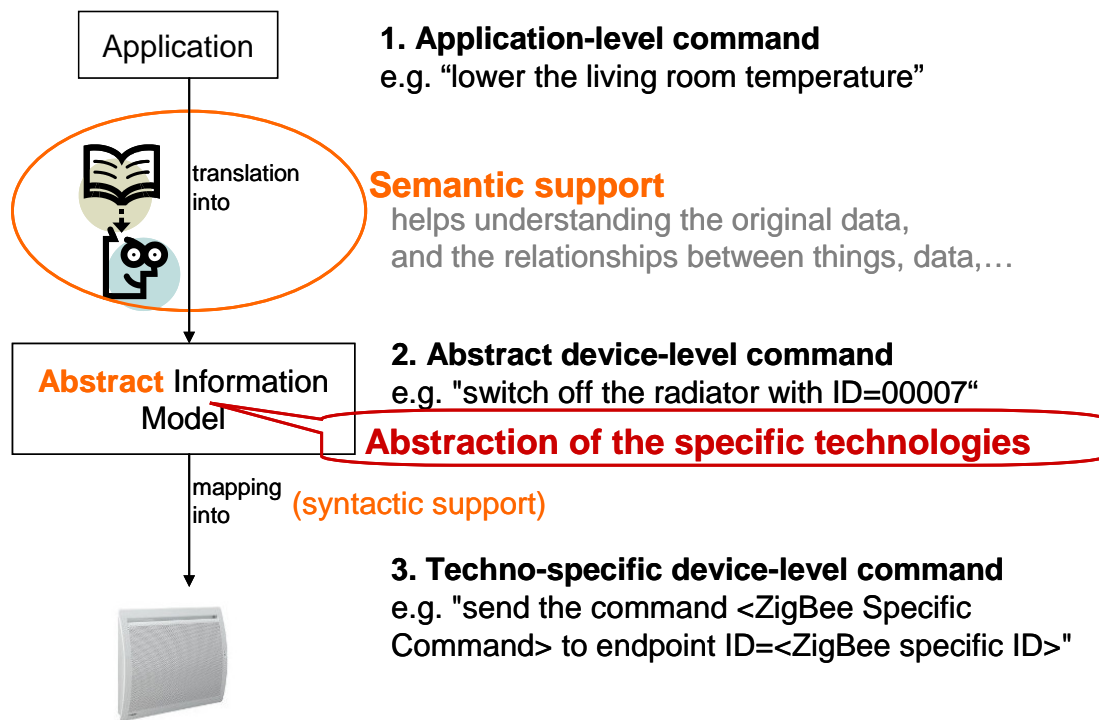

Figure 1: Abstraction versus Semantic for oneM2M

5.1.2 Basic Concept of Semantics

The current oneM2M approach treats data as black boxes, i.e. the content is opaque and applications have to a-priori know how to interpret the data. The result is a relatively tight coupling on the logical level (not the communication level) between the producers of data and the consumers of data. The consumer is programmed or configured for certain consumers. This typically requires a-priori agreement between the two regarding the meaning, i.e. the semantics of the data, which is then implicitly coded into the producer and the consumer.

Making the semantics explicit enables the platform to support additional functionalities like discovery, creation of mash-ups, and (big) data analysis.

However, there is not just one single level of semantics that could be attached to a raw data element. Figure 2 shows different levels of meaningfulness that can be identified.

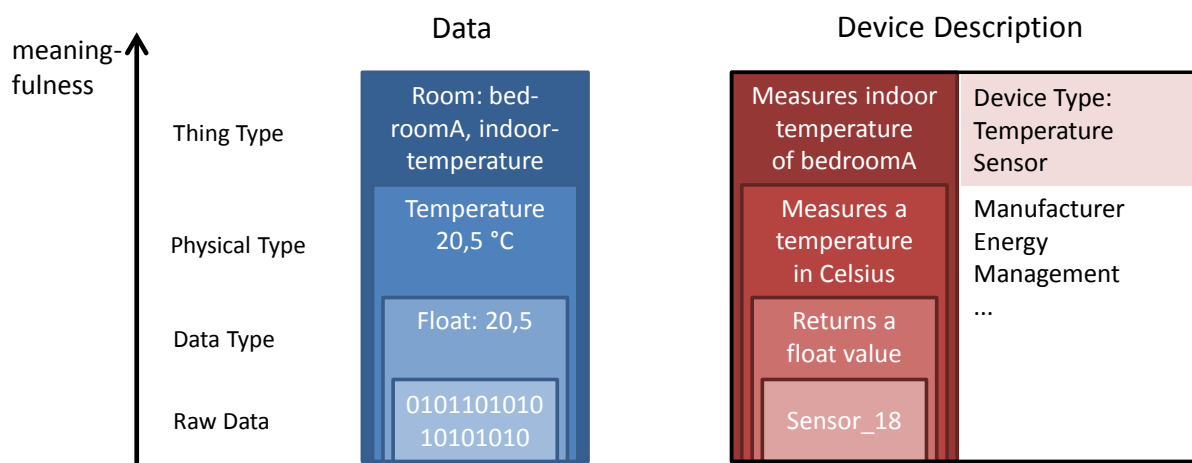

Figure 2: Levels of meaningfulness

The first level is the data type that defines how the raw data has to be interpreted to determine its value. In the example case, the raw data represents the float value 20,5. The physical type provides the meaning of the float value, i.e. that the float value represents a temperature given in Celsius. Finally, the thing type identifies the real-world thing and the aspect that is represented by the value. In the given case, the indoor temperature of the room with the name bedroomA.

Devices can also be semantically described. If a device produces data, the semantic description of the output directly corresponds to the semantic description of the data, as shown in Figure 2. In addition, other aspects can be semantically described, e.g. the device type, the manufacturer, the energy consumption, management information.

5.2 Use Cases Analysis

The following other use cases from TR-0001 [i.29] have semantic aspects:

- Use Case on Devices, Virtual Devices and Things (see [i.29], Section 8.2)
- Semantic Home Control (see [i.29], Section 9.6).
- Semantic Device Plug and Play (see [i.29], Section 9.7)
- Vehicle Diagnostic & Maintenance Report (see [i.29], Section 10.1)

The Annex A introduces several use cases for abstraction and semantics to identify key functionalities and potential requirements. The following table summarizes key functionalities and potential requirements for all use cases described in the Annex.

Section	Name	Key functionalities	Potential requirements
A.1	Home Environment Monitoring Service using semantic mash-up	Semantic mash-up	-
A.2	Semantic Home Control [NOTE-1]	Ontology model (ThingType, DeviceType)	-

		Semantic query	
A.3	Gym Use Case	Ontology model of treadmills Semantic query	<ul style="list-style-type: none"> • The M2M System shall provide the capability to publish semantic descriptions. • The M2M System shall support parsing and interpreting semantic descriptions. • The M2M System shall support resource discovery based on semantics.
A.4	Intelligent Alarm Service using Semantic Discovery and Mash-up	Semantic discovery Semantic mash-up Ontology model	<ul style="list-style-type: none"> • The M2M System shall provide capabilities to represent device and service information using ontology for service discovery, mash-up and data analysis.
A.5	Semantic Home Automation Control	Semantic appliance template Home automation ontology model Semantic query	<ul style="list-style-type: none"> • The M2M system shall be able to support semantic modelling device template for diverse M2M devices (e.g. household appliances). • The M2M System shall support common ontology to model the semantic information of M2M devices and the real-world entities (e.g. rooms) that associate with M2M devices. • The M2M System shall support semantic query to enable the discovery of target M2M devices based on their semantic information.
A.6	Semantic smart building light control	Semantic annotation Triple stores with the relationship of multiple ontologies Semantic query Reasoning	<ul style="list-style-type: none"> • The oneM2M systems shall support the reasoning capability for deriving implicit knowledge from semantically annotated information according to referenced ontologies.
7	Smart Home load control	Context-based reasoning Semantic query	<ul style="list-style-type: none"> • The M2M System shall provide the capability for entities of the M2M system (e.g. AEs, or CSEs) to publish semantic descriptions within the M2M system. • The M2M System shall support parsing and interpreting semantic descriptions. • The M2M System shall support resource discovery

			based on semantics.
--	--	--	---------------------

Table 1 Use Cases Analysis

[NOTE-1] this use case extends a use case of the same title in [i.29], Section 9.6.

5.3 Benefits of Abstraction and Semantics

By hiding the complexity of underlying networks, the Abstraction feature simplifies M2M for users and Applications developers. As services become independent of the various specialized technologies, it gives the opportunity to the Applications developers to focus on innovation of new services, which eventually fosters the development of the M2M market.

Semantic support for M2M, by describing the meaning of M2M data, that will also re-use existing semantics from vertical domains, is a way to enhance interoperability between initially “siloeed” applications. Another key benefit from Semantic is that it enables Applications to directly interact with real-world entities, through their virtual annotated-representation

6 Abstraction Technologies

6.1 Overview

Device Abstraction is a M2M Service that allows an M2M Application to use a generic, “abstract” interface to access the functions a set of devices irrespective of the specific technology they support.

The following requirements on Abstraction can be found in TS 0002

Requirement ID	Description	Release
ABR-001	The M2M system shall provide a generic structure for data representation.	
ABR-002	The M2M system shall be able to provide translation mechanisms among Information Models (including meta-data) used by M2M Applications, M2M Devices/Gateways, and other devices. <i>Editor’s Note: need definition for Information Model and Meta-data.</i>	
ABR-003	The M2M System shall provide capabilities to represent Virtual Devices and Things, (which are not necessarily physical devices.)	

Table 2 Abstraction Requirements

6.1.1 Basics about Interworking and Abstraction

Many systems (standardized and proprietary) that have been defined outside of oneM2M will require interworking with the M2M System. For example in the area of Home Automation ZigBee Smart Energy (SE2.0) and BACnet provide standards that describe devices and functionality to manipulate electrical machines in the home. OneM2M will need to interwork with both.

Interworking

Interworking the oneM2M System with these external systems/technologies allows an M2M Application to use devices from other technologies (e.g. ZigBee or BACnet) that are attached to the M2M System. Interworking is accomplished by Interworking Proxy functions, which could be realized as a M2M Application or as part of some CSE, that map the native interface of the device (e.g. ZigBee, BACnet,...) into oneM2M resources that can be accessed by M2M Applications. These resources are called a oneM2M Representation of the Information Model of the native device. Therefore, for interworked devices the M2M Application does not have to communicate with the device via its native interface but via interfaces (X and possibly Y) provided by oneM2M – the oneM2M Representation. Still, the M2M Application needs to understand the information model and the semantics of the native interface, even if the external (non-oneM2M) devices can be accessed through oneM2M mechanisms.

Abstraction

In addition to interworking the target of Abstraction is to enable an M2M Application to access the external (non-oneM2M) devices *without the need* to understand the information model and the semantics of the native interface. To meet that goal “abstract” devices are created in the oneM2M System. These Abstract Devices are M2M Applications or functions, located in a CSE, that translate access to its interfaces into access to interfaces of a native device. An Abstract Device can do this translation to devices from a multitude of external technologies. Instead of communicating with the native device – or, to be more precise, with the related Interworking Proxy function – the M2M Application communicates with the Abstract Device and only needs to understand the information model of the Abstract Device.

The following Figure 3 gives an overview on Interworking and Abstraction.

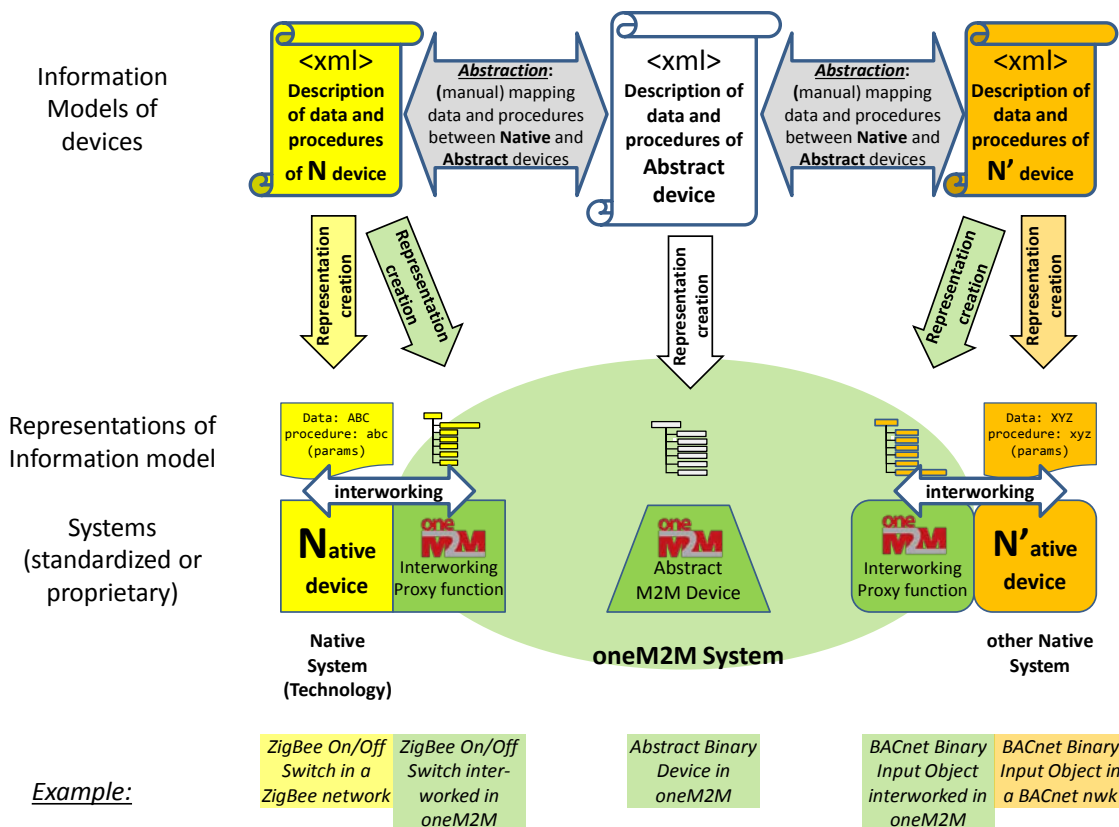

Figure 3: Interworking and Abstraction

6.1.2 Information models for Interworking

In this section we explain the difference between Information Model and a Representation of that Information model.

Additionally, we suggest that any Information Model, that can be used for interworking purposes, needs at least to be capable to differentiate between pure data operations (Create/Read/Update/Delete) and procedure calls. While CRUD operations are sufficient in pure RESTful systems, RPC based systems require an Information Model that allows to describe procedure calls.

Information Model

An Information Model is an “abstract, formal representation of entities that may include their properties, relationships and the operations that can be performed on them”. In particular, the Information Model describes the interfaces (their datatypes and -structure) with which the entity communicates with other entities.

In general, it is not necessary for an M2M Application (i.e. an entity, that is defined outside of oneM2M) to reveal to the M2M System (i.e. to CSEs via the X reference point) the internal – application specific – structure of the data it wants to exchange with other M2M Applications. In this case the interface to other M2M Applications would consist of an opaque “Container” sub-resource. The M2M System would not know about the internal structure of this container, the container could even be encrypted.

However, in the case of interworking of external systems / devices with the M2M System such information is required by the M2M System to be able to realize the related Interworking Proxy functions.

The information on the structure of an interface to an entity (e.g. application, device..) is called its “Information Model”. It describes the names of parameters, its value ranges, substructures, etc. If the interface is using procedure calls it must contain information about whether parameters are input- or output-parameters.

Representation

Note, however, that the Information Model of an interface is independent of any concrete system to which it may apply (e.g. ZigBee, oneM2M ..). It is merely describing what data are transferred across an interface. The system specific implementation of the Information Model in a specific system is called the “Representation” of the Information Model in that system.

For example, the Information Model of a ZigBee On/Off Switch has (naturally) a Representation in a ZigBee network, but can also have a Representation in the M2M System (for the purpose of interworking with ZigBee).

Requirements on the Information Model

It should be possible to describe the Information Model of any kind of interface - whether it observes REST principles or is procedure based – in a common format. In addition the format in which Information Models are described should be machine readable to enable automatic creation of a Representations of the Information Model in the target system.

A natural choice for such a format would be XML. More specifically, since an Information Model contains only the structure and not the actual values of an interface it can be described as an XML Schema, as an XSD file [see <http://www.w3.org/XML/Schema>].

Examples for existing XML Schemas are:

- XSD for BBF’s TR-069 CWMP data model for device management:
<http://www.broadband-forum.org/cwmp/cwmp-datamodel-1-1.xsd>
- ...

A shortcoming of existing published XML Schemas is that they usually describe only data and do not contain a description of procedures. The difference in describing procedures as compared with other data structures is that:

- Input- and output-parameters need to be clearly separated from each other
- While the input parameters of a procedure can be individually set, one at a time, this setting of parameters does not yet imply that the procedure is executed. Only “invoking” the procedure executes it.
- A procedure may take some time to execute, so after invocation the output, relating to that invocation, may not be available until the procedure has finished.
- After invocation, a procedure may have different states (e.g. “invoked”, “started”, “paused”, “finished”..) that may be relevant (e.g. to interrupt procedure execution).

For that reason it is important that an Information Model clearly distinguishes between data and procedures.

The xsd for a procedure could roughly look like:

```

<?xml version="1.0"?>
<xsd:schema xmlns:xsd="http://www.w3.org/2001/XMLSchema">
<xsd:element name="procedure" type="procedureType"/>
<xsd:complexType name="procedureType">
  <xsd:sequence>
    <xsd:element name="procedureName" type="xsd:string"
      minOccurs="1" maxOccurs="1"/>
    <xsd:element name="procCallParams" type="procCallParamsType"
      minOccurs="0" maxOccurs="1"/>
    <xsd:element name="methodResponse" type="methodResponseType"
      minOccurs="0" maxOccurs="1"/>
  </xsd:sequence>
</xsd:complexType>

<xsd:element name="procCallParams" type="procCallParamsType"/>
<xsd:complexType name="procCallParamsType">
  <xsd:sequence>
    <xsd:element name="params" type="paramsType"
      minOccurs="0"/>
  </xsd:sequence>
</xsd:complexType>

<xsd:complexType name="paramsType">
  <xsd:sequence>
    <xsd:element name="param" type="paramType"
      minOccurs="1"/>
  </xsd:sequence>
</xsd:complexType>

<xsd:complexType name="paramType">
  <xsd:sequence>
    <xsd:element name="value" type="valueType"
      minOccurs="1" maxOccurs="1"/>
  </xsd:sequence>
</xsd:complexType>

<xsd:complexType name="valueType">
  <!--
  Here the data types from other XSDs (from existing data models) can be included
  -->
</xsd:complexType>

<xsd:element name="methodResponse" type="methodResponseType"/>
<xsd:complexType name="methodResponseType">
  <xsd:sequence>
    <xsd:element name="params" type="paramsType"
      minOccurs="0"/>
  </xsd:sequence>
</xsd:complexType>

</xsd:schema>

```

In the past, several attempts have been made also to describe procedures in XML, e.g. XML-RPC [<http://en.wikipedia.org/wiki/XML-RPC>], which later evolved into SOAP/WSDL. However these later evolutions were targeting the use of XML for indeed implementing RPCs (i.e. to be used at runtime), which is not needed if we only want to describe the structure of a procedure.

6.1.2.1 Mapping Information Models into oneM2M Resources:

For interworking purposes for a given Information Model oneM2M Resources need to be created according to the structure given by the Information model.

In particular, when the Information Model is specified by an XSD file the following rules should apply:

- Attribute names shall be the same ones as given in the element name of the XSD description
- Simple atomic attribute types (like “Boolean”, “integer”, “string” ..) shall be indicated in the Description of the resource.

- Attributes of type “sequence” shall be mapped into a Collection Resource with the same name as the element name of the XSD description.
- Resources that represent Procedures contain
 - A sub-Resource which contains 0..1 sub-Resources "procCallParams"
 - A sub-Resource which is a collection of execution Instances.
 - Each execution Instance contains 0..1 sub-Resource "methodResponse".
 - A special attribute “execEnable”. An UPDATE on that attribute will trigger execution of the procedure with the current "procCallParams" parameters

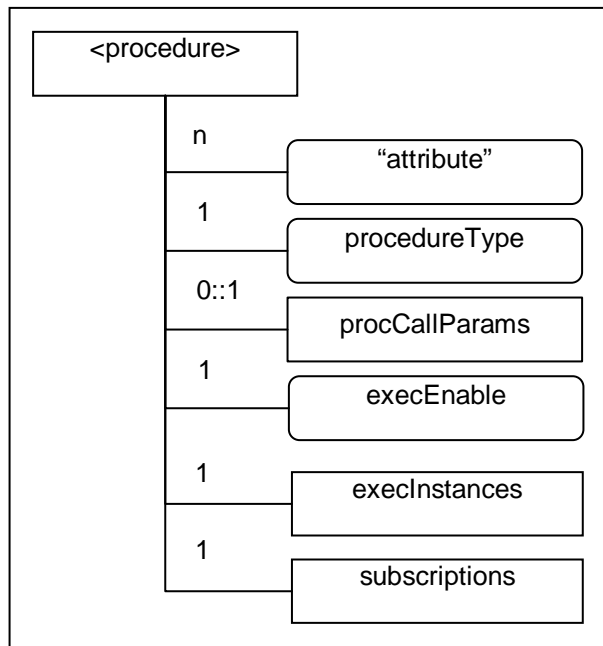

Figure 4

6.1.2.1 Proposal:

It is proposed that oneM2M should encourage external bodies, who wish to interwork with oneM2M, that similar approach should be taken and Information Models should be published as XSD files.

A convention on how to express the xsd description of procedures – similar to the one given above – needs to be established.

6.1.3 Abstraction and Semantics

A common format for describing Information Models, as described above, facilitates creation of system specific interface Representation (e.g. as oneM2M Resources) for external systems/entities. This allows easy creation of Interworking Proxy functions.

However, from the oneM2M Resource representation it cannot be deduced that a particular resource has been built according to a published Information Model. E.g. although all the parameters in a resource are called exactly the same way as described in BBF’s TR-069 CWMP data model this still may have happened by coincidence.

If it is desired to indicate that Resources have been built according to a specified Information Model, these Resources should contain a special attribute that contains a link to the XSD of the Information Model. That way it is always possible to ensure compliance of the Resource structure with that Information Model

In addition, this link would allow to search for entities that comply with that Information Model (e.g. devices of a particular TR-069 Device Type).

Semantics

The Information Model (the XSD file as described above) only describes the structure of the interface to entities (oneM2M or external). However it does not describe any semantics (i.e. the meaning of data / behaviour of entity types). To enable the described abstraction, the semantic relation between each concrete instance (e.g. the ZigBee Information Model) and the common super type (the Abstraction Information Model) has to be modelled.

For example, within a home environment one light switch might implement the ZigBee protocol, another one the BACnet protocol. The first one would have a type “ZigBee On/Off Switch”, the type of the second one would be “BACnet Binary Input Object”. Only knowing their types and Information Model would not allow the conclusion that both are light switches.

This additional (semantic) information could be added by adding references to an ontology, that defines “ZigBee On/Off Switch” and “BACnet Binary Input Object” as sub-classes of “binary switch”.

Depending on how the Information Model of an Abstract Device for a binary switch would in the future look like, another sub-class “ABSTRACT Binary Input Object” could be created in that ontology and would be a sub-class (or maybe an equivalent class) to “binary switch”.

Such semantic information, which basically would consist of vocabulary of class-type names and their relationship (e.g. sub-class of ...) can be formally described in an ontology. The most common languages for describing ontologies are RDF(S) and OWL. RDF (Resource Description Framework) allows making statements as triples consisting of subject, predicate and object. RDFS (Resource Description Framework Schema) provides a vocabulary for structuring RDF Resources. This includes the modelling of classes (rdfs:Class), the rdf:type property that links instances to a class and the rdfs:subClassOf property, which allows the specification of class hierarchies. SPARQL is a query language for RDF triples that takes into account the subclass relations. OWL (Web Ontology Language) goes a step further enabling ontology reasoning. OWL offers different sublanguages with different levels of expressiveness and related properties regarding reasoning completeness and time complexity. Ontology reasoning can be used to deduce subclass relations, to determine whether something is an instance of a class and to check consistency.

While the capability for semantic search (e.g. give me all instances of classes that are sub-classes of “binary switch”) is clearly of importance for oneM2M as it will allow satisfying identified search requirements, further aspects related to the need of supporting ontology reasoning require some further study.

Abstraction

Also, ontologies, depending on the granularity of their entries, may contain information on the mapping between Abstract Device Information Models and ‘real’ Device Information Models. E.g. it could be stated that the “On” state of the ZigBee On/Off Switch corresponds to the “TRUE” state of the “ABSTRACT Binary Input Object”.

6.1.3.1 Proposal:

For the purpose of abstraction, it is not absolutely necessary to have semantic information available in the oneM2M System. Nevertheless, it should already now be foreseen in the design principles to add semantic aspects to the resources in the oneM2M System.

We propose to add semantic information by linking resources to ontology concepts, e.g. as specified in RDF or OWL ontology files.

6.2 Introduction of Existing Technologies

6.2.1 Introduction to ETSI M2M Device Abstraction

6.2.1.1 Architecture

Native devices (type d) can host several applications. For example, a ZigBee device can have several on/off switches. Each switch is a distinct application and needs to be registered to the Gateway as well as the Network. As specified in the TS 102 690 [i.1] section 6.1, the GIP capability provides interworking between non ETSI compliant devices and the GSCL.

Figure 5 [i.2] shows a high-level architecture for supporting device abstraction. Native devices (e.g. ZigBee devices) are first registered in the GSCL as native applications through the GIP capability. These native applications are then abstracted in corresponding abstract resources through a capability supporting device abstraction, which is called the Gateway Resource Abstraction (GRA) capability. Both native and abstracted applications are then registered (or announced) to the NSCL via mld interface. Both GSCL and NSCL have abstract resources in their resource tree.

This architecture provides both legacy M2M applications, which have access network specific knowledge, and standard M2M applications to have an access to native resources. The legacy M2M applications can access through the native applications while the standard M2M applications do through the abstracted resources.

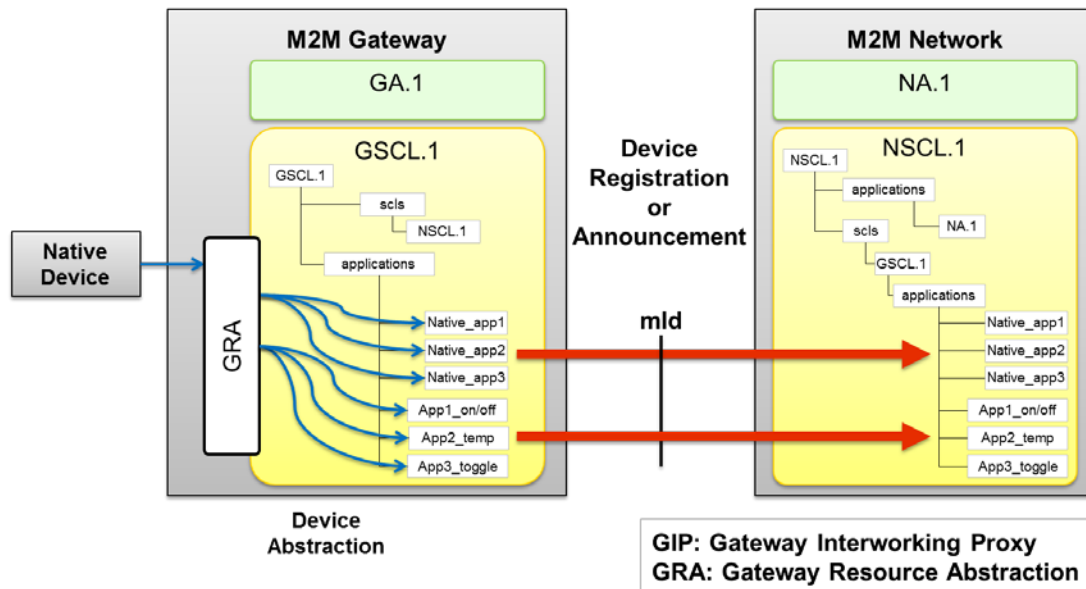

Figure 5: High-level architecture for supporting device abstraction

6.2.1.2 Interworking with legacy devices (d) through abstract devices

The following Figure 6 provides a resource-entity model that represents an M2M area network. In this model, each device in the network has native data and methods which are provided via access network-specific interfaces to applications. In order to provide interworking with M2M network applications that do not understand access specific technologies, the model defines an abstract application and linked it to its native application.

Since not all native applications are directly mapped to an abstracted application, the model provides 1 (native application) to 0..n (abstract application) relationship. All child entities of both native and abstract application such as interface, data field and method have the same 1 to 0..n relationship.

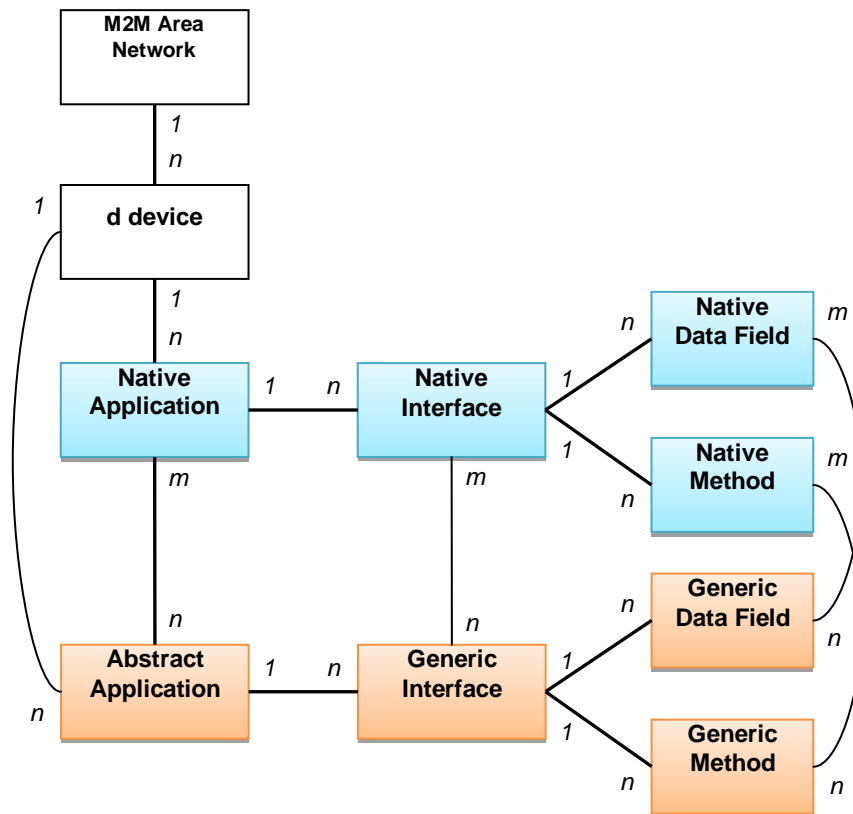

Figure 6: Generic entity-relation diagram for an M2M Area Network and its resources

This entity-relation diagram is applicable to the following M2M Area Networks:

- ZigBee
- DLMS/COSEM
- Zwave
- BACnet
- ANSI C12
- mBus

Native resource.

Native resource is an Application resource specified in the TS 102 690 that shall store network specific information about the Application. Same as application resource, native resource is created as a result of successful registration of an Application with the local SCL. M2M network applications that understand network specific information can interwork with legacy devices (d) through this native resource.

Abstract resource.

An abstracted resource shall point to the native resource hosted in another SCL or in the same SCL. The abstracted resource is a virtual resource which consists of a set of generalized attributes instead of local area network specific attributes, such as, the *searchStrings*, the *abstractLink* to the original resource, a set of *genericCommands*, which are visible to applications (e.g. toggle, on and off), and the *accessRight*. The purpose of the abstracted resource is to represent the original resource without any network-specific information, so that the issuer does not need to know about any prior knowledge of the used underlying network technology. An abstracted resource itself shall be considered the same as other native resources that are located in the same SCL. When an abstracted resource is discovered, it returns a direct reference to the native resource.

6.2.1.3 Gateway Resource Abstraction (GRA) Capability

At start-up of forming a local area network, the GIP capability detects new devices that have joined the network and creates original M2M resources on GSCL, which are specific to the local network technology. When the GIP capability

creates the original resources, the GRA capability detects new resources, creates their corresponding abstract resources and registers them in proper SCLs.

The GRA Capability in the M2M Gateway is an optional capability, i.e. deployed when needed/required by policies.

The GRA Capability provides the following functionalities:

- Detects any additions of new native resources in the GSCL.
- Generates an abstracted resource from the native resource, which is non ETSI compliant resource.
- Links native resources to their corresponding abstract resources.
- Registers abstract resources to the NSCL.
- Subscribes to native resources to be notified any updates.
- Synchronize abstracted resources to their native resources.
- Provides functional mapping between the abstracted information (i.e. generic attributes and commands) and the underlying network specific information.
- GRA may either be an internal capability of GSCL or an application communicating via reference point dIa with GSCL. GRA can also be merged with the xIP (i.e. GIP, NIP and DIP) capability, so that provides resource abstraction and interworking capabilities together.

6.2.1.4 Subscription of Abstract Resources

Any xA in the ETSI M2M architecture should be able to create a subscription to an abstract resource. The xSC is responsible for managing the subscription. Any xA that subscribes to an attribute value can be notified when the value changes.

6.2.1.5 Mapping Principle

This section describes the mapping principles that are used to map a generic M2M abstract resource into a native M2M resource. There exist two ways of describing an abstract device. The first one is to consider each abstract device as an application. The second mapping method uses the subcontainers resource so that each abstract device is considered as a *container* resource and registered to the network application where they are belonging to.

Representing the M2M Area Network using Link: Each abstract application belonging to a Device (N.B.: they are not ETSI M2M Applications) is modeled with an ETSI M2M <abstract-application> resource. The URI used to access this <abstract-application> resource has the following format:

```
<sclBase>/applications/<networkX_deviceY_abstract-applicationZ>
```

The <abstract-application> resource contains an ETSI M2M <container> sub resource. The URI used to access this <container> resource has the following format:

```
<sclBase>/applications/<networkX_deviceY_abstract-applicationZ>/containers/descriptor
```

The <container> resource contains one or more <contentInstance> sub resource. The “content” attribute of this sub resource contains the representation of the Application. In particular, since an Application can implement several Interfaces, each of them modeled with ETSI M2M resources (see next bullet for description), the “content” attribute of the <contentInstance> resource may contain the URIs of the ETSI M2M resources representing these Interfaces. The URI used to access the <contentInstance> resource containing the current representation of the Application has the following format:

```
<sclBase>/applications/<networkX_deviceY_abstract-applicationZ>/containers/descriptor/contentInstances/latest
```

The <contentInstance> resource pointed by the “latest” attribute of the contentInstances resource contains always the current representation of the Device.

Each Data Field and each Method belonging to an Abs_Interface is generalized from their corresponding native Data Field and method. Same as to the native one, they can be mirrored or retargeted.

If the Data Field or the Method is mirrored the ETSI M2M <abstract_application> resource modeling the Application contains an ETSI M2M <container> sub resource for each interface element mirrored (either Data Field or Method). The URI used to access this <container> resource has the following format:

```
<sclBase>/applications/<networkX_deviceY_abstract-  
applicationZ>/containers/<abs_interfaceW_datafieldN>
```

or

```
<sclBase>/applications/<networkX_deviceY_abstract-  
applicationZ>/containers/<abs_interfaceW_methodM>
```

The <container> resource contains one or more <contentInstance> sub resource. The “content” attribute of this sub resource contains the representation of the Data Field or the Method; for the Data Field it is its value, for the Method it is the actual parameters used for a Method invocation or the result of a Method invocation. The URI used to access the <contentInstance> resource containing the current representation of the Data Field or the Method has the following format:

```
<sclBase>/applications/<networkX_deviceY_abstract-  
applicationZ>/containers/<abs_interfaceW_datafieldN>/contentInstances/latest
```

or

```
<sclBase>/applications/<networkX_deviceY_abstract-  
applicationZ>/containers/<abs_interfaceW_methodM>/contentInstances/latest
```

The ETSI M2M <abstract_application> also has a link to its native <application>. The URI used to access the <native_application> resource containing the native representation of the resource has the following format:

```
<sclBase>/applications/<networkX_deviceY_native-applicationZ>
```

Figure 7 provides an overview of the resources used to model an example of an abstract device.

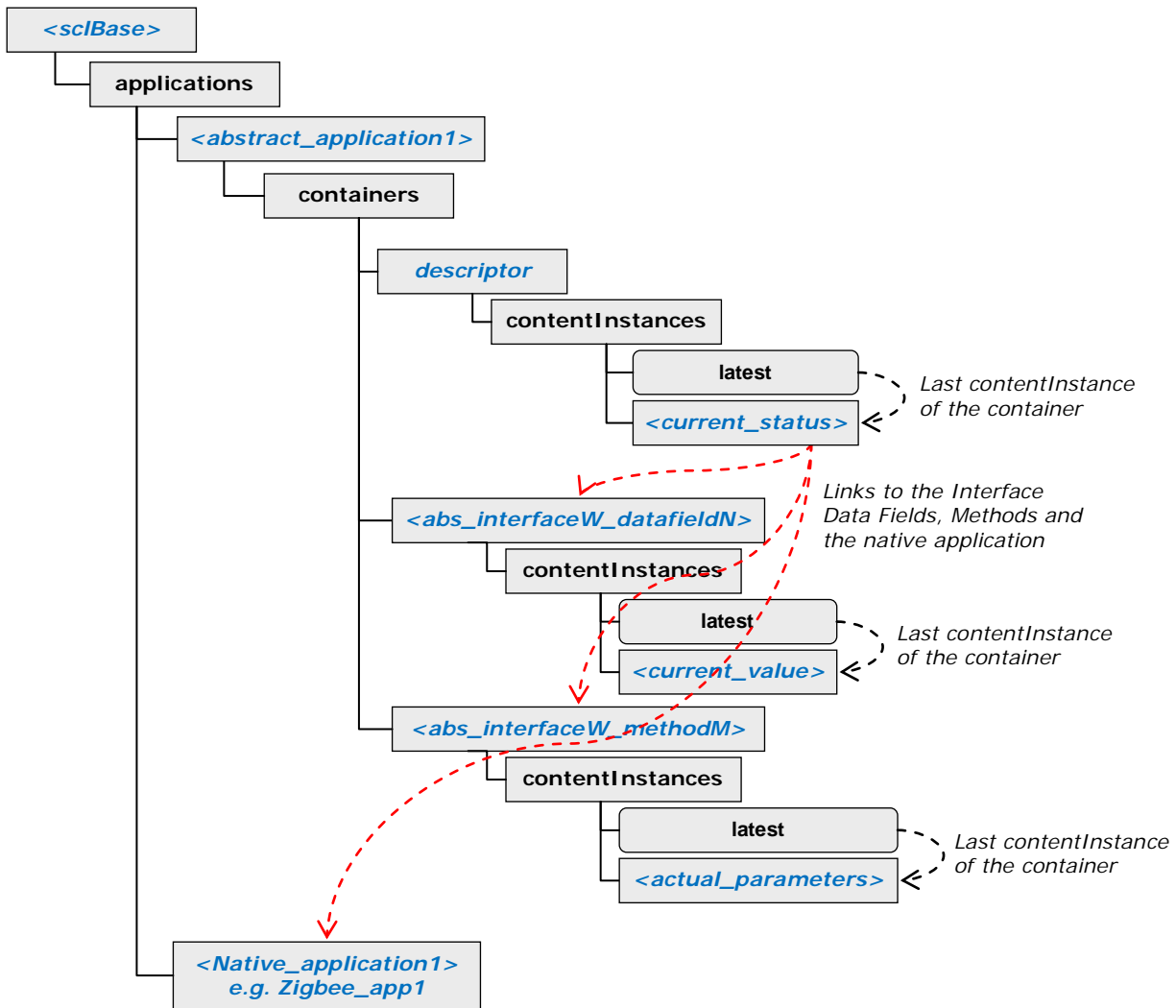

Figure 7 : Linking an abstract resource to its native resource based on the ETSI M2M resource architecture

Representing abstract device using subcontainers:

In this representation method, the “subcontainers” resource can be used instead of the link. The *subcontainers* resource is a resource that is used to represent a collection of sub-container <container> resources. Since the *subcontainers* resource links a <container> resource with sub-container <container> resources, e.g. ../containers/<parentcontainer>/subcontainers/<container>, all abstract devices and original devices are represented as a container.

For example, in the representation using subcontainers, each device regardless of type (i.e. abstract or original) is described as a container and included in the *subcontainers* of the M2M Area Network application resource. The URI used to access the <container> resource of an abstract device Y has the following format:

```
<sclBase>/applications/<networkX >/subcontainers/<networkX_deviceY_abstract_container>
```

while the <container> resource of an original device Y has the following format:

```
<sclBase>/applications/<networkX >/subcontainers/<networkX_deviceY_container>
```

The <subcontainers> resource contains one or more containers for devices. Figure 8 provides an overview of the resources used to model an example of an abstract device using the *subcontainers* resource:

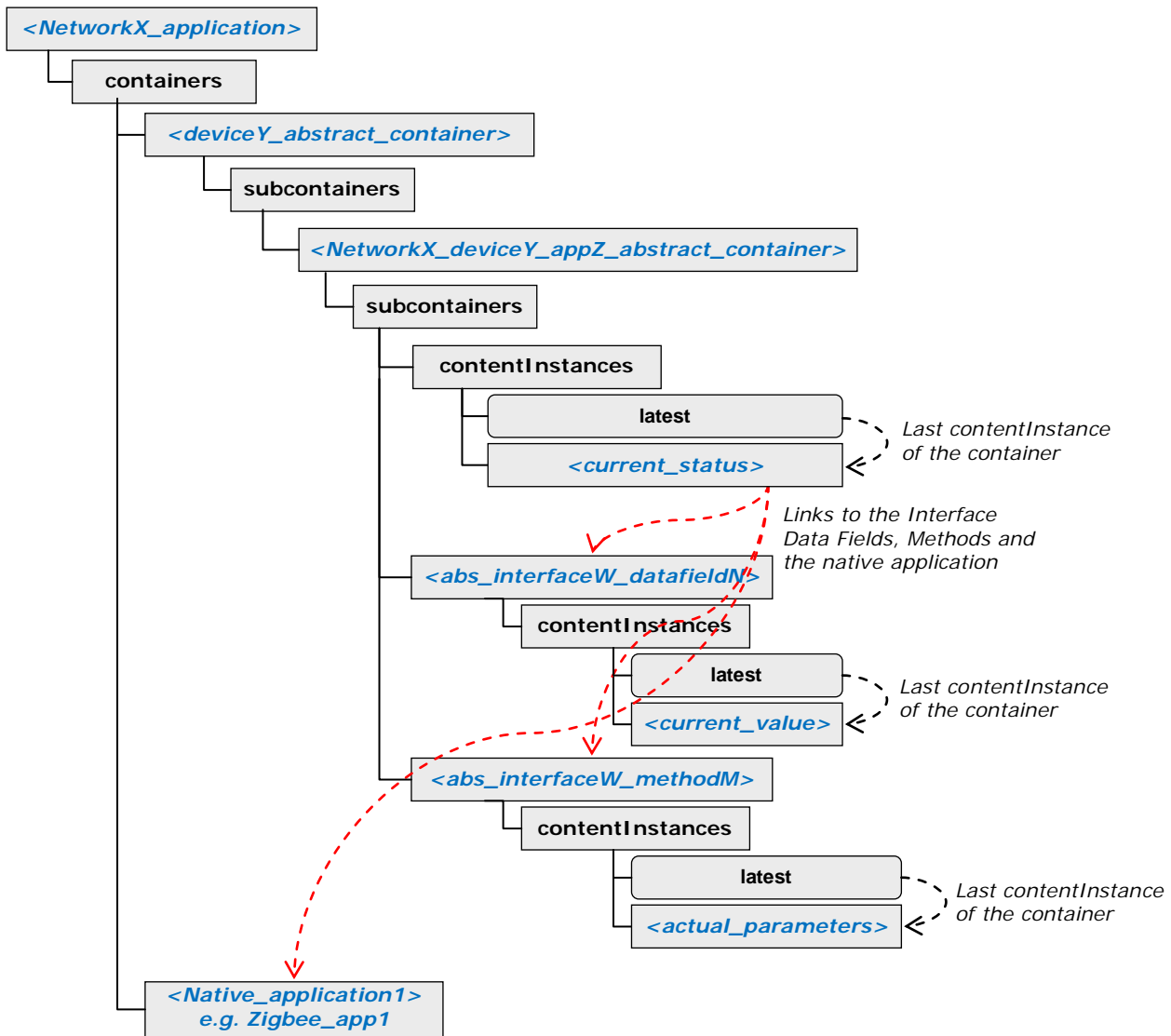

Figure 8: Mapping of an abstract device to the ETSI M2M resource architecture using the *subcontainers* resource

6.2.2 Introduction to Home Gateway Device Abstraction Concept

6.2.2.1 Architecture

Smart Home Abstraction Layer (SHAL) maps appliances to a common representation independent of the home automation technology. SHAL translates protocol-independent requests from applications to protocol-specific ones and then forwards them to the appropriate driver. SHAL represents an Abstract Application Interface for appliances – a technology agnostic description of appliances. The following Figure 9 shows a high-level conceptual architecture for Home Gateway device abstraction technology. [i.25]

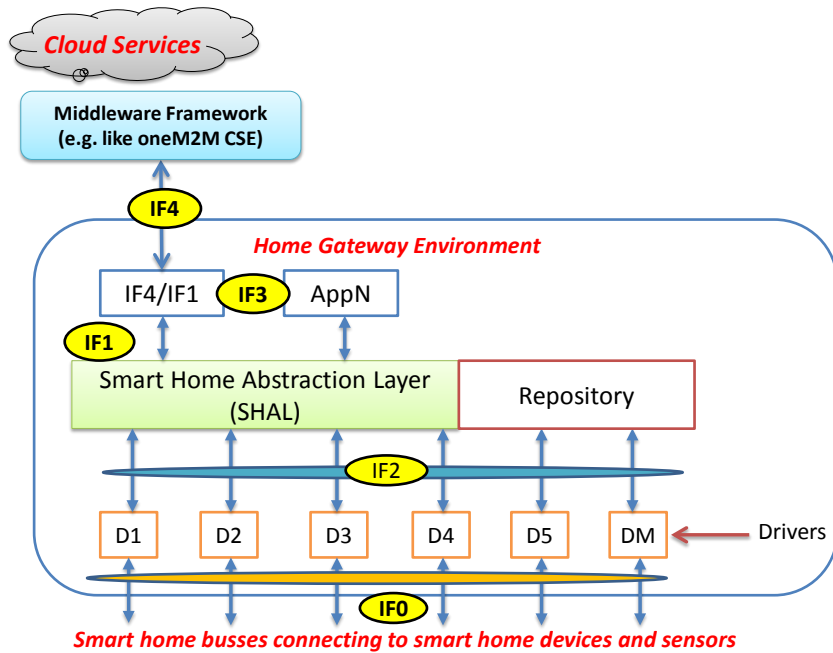

Figure 9: A high-level conceptual HGI architecture

IF1 Abstraction Application Interface: provides a common representation of appliances in the Home Domain to the Execution Environment, so that HG Applications can be independent of the different home automation technologies. For example a ZigBee lamp and a ZWave lamp are represented in the same way through an **Error! Reference source not found.** Service, so that an application can switch both off without dealing with Zigbee/ZWave specifics.

IF2 Device Application Interface: In some cases (mainly for management purposes) it is useful to have direct access to the home automation protocol, in order to do for example protocol-specific configuration or troubleshooting.

IF3: provides “higher-level” service application interface

IF4 Remote Representation: defines the representation of the abstract application interfaces for the backend over a remote protocol. The data corresponds to the data available through IF1, 2 and 3. This reference point also maps remote protocol events to a suitable local notification service for the HG apps.

IF0 External Reference Point: defines the external reference point with bindings to selected protocols.

SHAL Middleware translates ALL of protocol and data models into IF1 primitives what is needed by local networked Appliances. The Home Gateway supports the Cloud protocol(s) over IF4, providing required handshaking and (proxied) status information from Appliances. There is a need to extract the data and commands from the Cloud protocol and translate ALL aspects to primitives on IF1 software interface. Each driver for a local network technology MUST properly translate IF1 primitives into the (proprietary or standardized) signalling on the local network.

Main goals of SHAL are as follows:

1. To provide unified APIs for application developers to command, control and query home appliances
2. Independence of underlying HAN technologies so that an application developer doesn't need to know anything about Zigbee, Z-Wave, wireless m-bus etc.
3. To enable applications to be portable across different HGI compliant devices
4. To enable extending the system with additional HAN technology support without service interruption
5. Application should be able to use a pass-through mechanism to use technology-specific functions

The abstract appliance interface descriptions should be mappable to various environments such as Java and/or OSGi, other execution environments (i. e. iOS, Android), REST APIs and other remote protocols (SOAP, CORBA etc.)

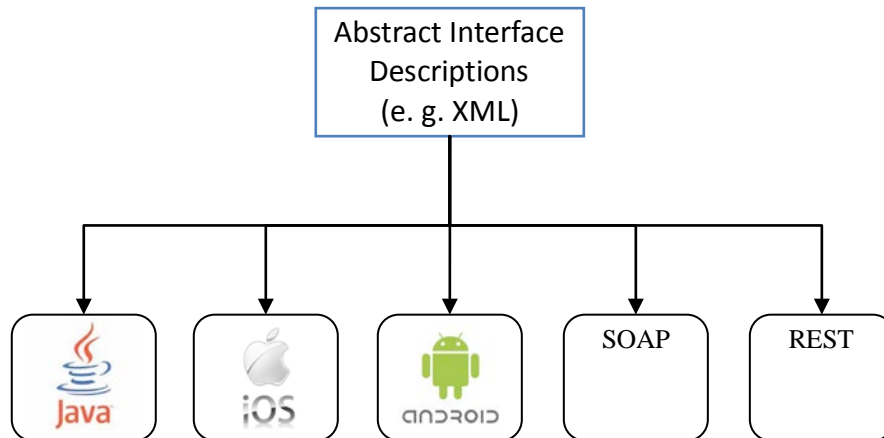

Figure 10: Abstract Interface Descriptions

6.3 Specific requirements for abstraction

Requirement ID	Description	Release
ABR-001	The M2M system shall provide a generic structure for data representation.	
ABR-002	The M2M system shall be able to provide translation mechanisms among Information Models (including meta-data) used by M2M Applications, M2M Devices/Gateways, and other devices.	
ABR-003	The M2M System shall provide capabilities to represent Virtual Devices and Things, (which are not necessarily physical devices.)	

7 Technologies for Semantic M2M System

7.1 Overview

7.1.1 Introduction to Semantics technologies

Semantics can provide machine interpretable descriptions using meta-data and annotations. These descriptions contain various information for data, users, devices, applications, environments. Semantics also can help describing different attributes of M2M devices and data.

The following requirements on Semantics are specified in TS 0002.

Requirement ID	Description	Release
----------------	-------------	---------

SMR-001	The M2M System shall provide capabilities to manage semantic descriptions of resources and M2M Applications, e.g. create, retrieve, update, delete, associate/link.	
SMR-002	The M2M System shall support a common modeling language for semantic descriptions (including relationships between Things) in order to make them available to M2M Applications.	
SMR-003	The M2M System shall be able to provide interworking capabilities between different modeling languages for semantic descriptions.	
SMR-004	The M2M System shall provide capabilities to discover M2M Resources based on semantic descriptions.	
SMR-005	The M2M System shall support the capability to access semantic descriptions which are outside of the M2M System.	
SMR-006	The M2M System shall be able to support capabilities for performing M2M data Analytics based on semantic descriptions from M2M Applications and /or from the M2M System.	
SMR-007	The M2M System shall be able to provide capabilities for performing Semantic Mash-up using M2M data from M2M Applications and/or from the M2M System (e.g. to create Virtual Devices, offer new M2M Services, etc.)	

Table 3: Semantics Requirements

Basically, semantic technology aims to provide semantic interoperability for accessing resources/services and interpreting data from different stakeholders.

From the high-level requirements, the following key technologies for supporting semantics have been identified.

- **Semantic annotation** for providing semantic information of various entities (e.g., data, user, application, etc.) that complement M2M data of these entities
- **Use of Ontologies** for modelling semantics of physical, virtual and abstract entities. Ontologies need to have machine-readable representations, using standard languages, for use in oneM2M
- **Semantic processing**
 1. **Semantic discovery**, enhancing the M2M discovery mechanism, to allow locating and linking resources or services based on their semantic information
 2. **Semantic reasoning** to derive new relations and classifications of semantically annotated data
 3. **Semantic mash-up** for creating a new virtual devices and offering new M2M services

7.1.2 Key functionalities for Semantics

Figure 11 shows a generic functional model to support semantics for various M2M applications. The functionalities of Figure 11 are logically composed of three main parts:

- **Service access** which provides an interface with various M2M applications;
- **Abstraction & semantics** which perform main functionalities for semantics to M2M data and resources;
- **Data access** which provides connections with a device and/or a gateway for accessing M2M data.

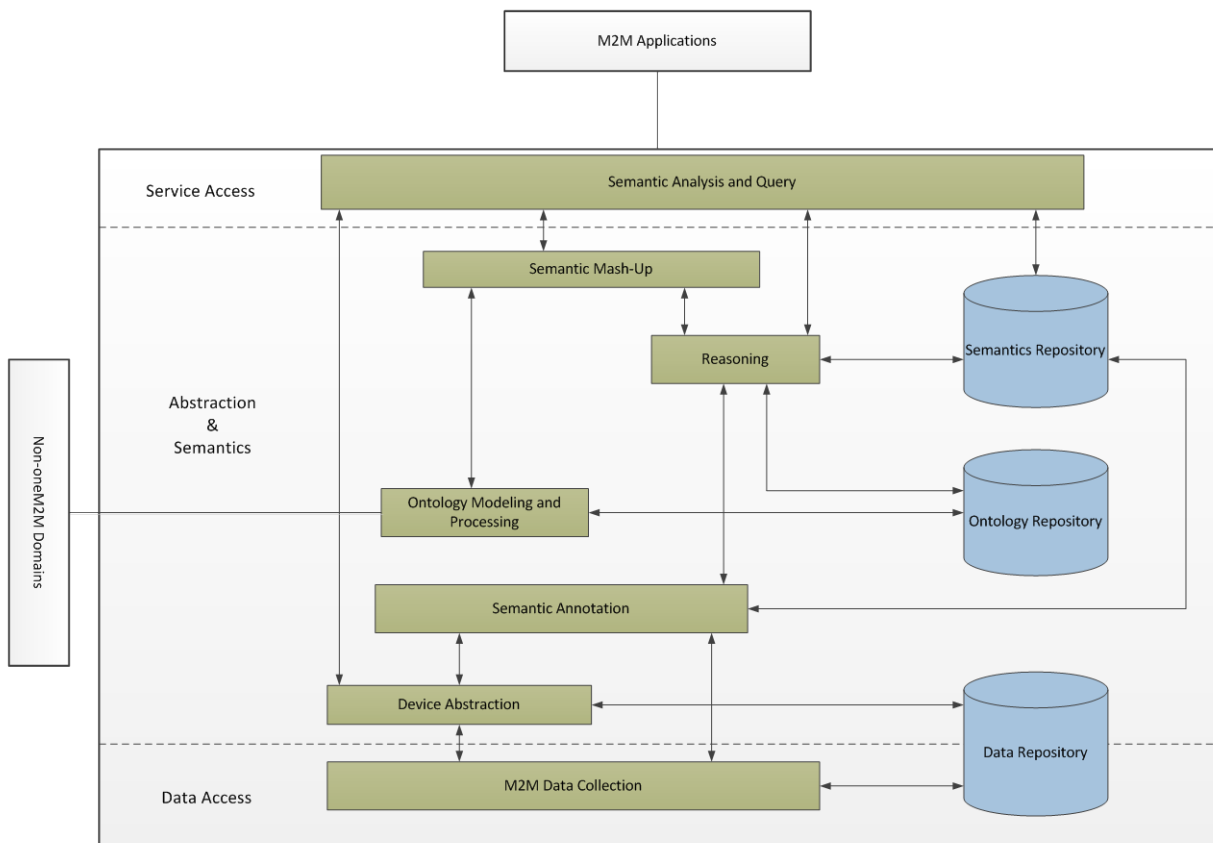

Figure 11: Generic functional model for supporting semantics

7.1.2.1 Semantic Analysis and Query

In semantic analysis and query, the requests from an M2M application are analyzed semantically. Based on the analysis, it creates semantic query messages and sends the messages to functional components (e.g., ontology repository, reasoning, semantic mash-up, etc.) in abstraction and semantics for requesting semantic information. After obtaining the requested information, it responds to the M2M application.

7.1.2.2 Reasoning

Reasoning is a mechanism to derive a new implicit knowledge from semantically annotated data and to answer complex user query. It can be implemented as a piece of software to be able to infer logical consequences from a set of asserted facts or axioms.

7.1.2.3 Ontology Repository

Ontology repository is storage of ontologies. Ontology is a formal specification of a conceptualization that is defining concepts as objects with their properties and relationships versus other concepts. Therefore, Ontology can be defined as a linguistic artifact that defines a shared vocabulary of basic concepts for discourse about a piece of reality (subject domain) and specifies those concepts including operations.

Ontology repository provides a way for storing, retrieving and maintaining of ontology which is described as OWL or RDF. It should be able to handle large-scale data sets with a lot of concepts for various purposes (e.g., publishing, sharing, indexing, searching, reuse of ontology, etc.). It support languages for query (e.g., RDF Data Query Language(RDQL), QWL Query Language(QWL-QL), SPARQL Protocol And RDF Query Language(SPARQL), etc.).

7.1.2.4 Ontology Modelling and Processing

Ontology modeling is the process for building an ontology which is used to model a domain and support reasoning about concepts. Examples of languages for ontology modeling are XML-based RDF, RDF Schema(RDFS), OWL, etc.

Ontology Processing is the process of classifying, storing and providing discovery function of published/modeled ontologies from external and internal of the M2M domain. The ontologies are converted and stored in Ontology repository in a unified language (e.g. RDFS/OWL) that can be shared and used to enable semantics to resources.

7.1.2.5 Semantic Mash-up

Semantic mash-up provides functionalities to support new services through the creation of new virtual devices, which do not exist in physical world, by obtaining semantic information through semantic descriptions from existing M2M resources in the M2M System.

7.1.2.6 Semantic Annotation

Semantic annotation of M2M resources is a method for adding semantic information to M2M resources so that it provides consistent data translation and data interoperability to heterogeneous M2M applications. Semantically annotated M2M resources can be contacted by an M2M application that understands what data are provided by the resources and what these data means. These annotations provide more meaningful descriptions and expose M2M data than traditional M2M system alone. Semantic information is annotated using Resource Description Framework(RDF) or Web Ontology Language(OWL).

7.1.2.7 Semantics Repository

Semantics repository stores the semantics annotations of resources. Semantics repository also stores the new implicit semantics information from the result of reasoning. It supports languages for query (e.g., RDF Data Query Language(RDQL), QWL Query Language(QWL-QL), SPARQL Protocol And RDF Query Language(SPARQL), etc.).

7.1.2.8 Device Abstraction

Device abstraction is a process of mapping between a set of Device Application Information Models and an Abstract Application Information Model according to a specified set of rules. It allows to communicate with multiple, different but semantically similar devices through a virtual device that offers the functionality of the abstracted Application Information Model.

7.1.2.9 Data Repository

Data repository basically stores new data. In addition, it also provides functions to support the search, modification and deletion of the stored data.

7.1.2.10 M2M Data Collection

From devices with sensors and/or gateways, raw data are collected and stored in data repository.

7.2 Introduction of Existing Technologies

7.2.1 Introduction to ETSI Semantic M2M System

7.2.1.1 System Overview

Figure 12 [i.2] describes a high-level architecture of Semantic M2M with internal components.

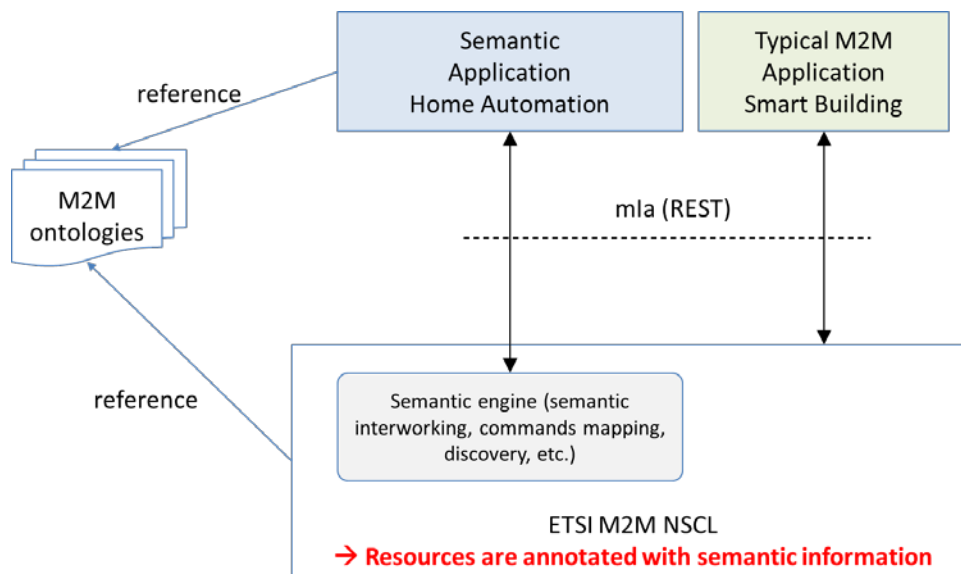

Figure 12: Semantic M2M system overview

Semantic engine:

Semantic engine plays a key role in Semantic M2M system. Similar to interworking proxy capabilities (xIP) in NSCL [i.1], semantic engine can be deployed in NSCL. For discovery, the engine receives a semantic query; handles the query and returns results.

Semantic engine provides functionalities as follows:

- validate semantic attributes (according to semantic model, e.g., RDF and OWL, either defined by ETSI M2M or outside of ETSI M2M),
- process semantic queries, for example decomposing a query into multiple sub-queries, aggregating the results from sub-queries.

M2M ontologies:

M2M ontology is a formal description of M2M resources, of the structures of things, properties, processes and their relationships in a domain.

7.2.1.2 Semantic Annotation

Semantic annotation of M2M resources is a method for adding semantic information to M2M resources so that provides consistent data translation and data interoperability to heterogeneous M2M applications. Semantically annotated M2M

resources can be contacted by an M2M application that understands what data are provided by the resources and what these data means. These annotations provide more meaningful descriptions and expose M2M data than traditional M2M system alone.

In brief, M2M resources usually consist of sensor devices monitoring and reporting a specific data and actuators executing a given command. Comparing with other semantic services, such as Semantic Web and Semantic Sensor Web, semantic M2M needs to provide semantic information for both data and commands.

In many cases, semantic information is annotated using RDF because RDF provides a general, flexible way to decompose any knowledge into discrete pieces and can be stored in many different formats. In addition, RDF is useful to encode information about relations between things which includes a lot of semantic information. A triple store is usually selected in order to store and retrieve such relational information. However, ETSI M2M uses a hierarchical resource tree to store resource information and provide discovery of these resources.

The first step towards a semantic M2M system is to annotate semantic information to its managing resources. Semantic information is retrieved from the relations between M2M resources and can be annotated as an attribute of the resources. The ETSI M2M system uses a hierarchical tree structure to store and represent its resources. Thus, in the ETSI M2M system, semantic information can be retrieved from the relations between M2M resources and embedded as an attribute of the resources.

The *semanticInfo* attribute contains the semantic description of the thing. This ontology shows what is the meaning of the thing. This semantic description is expressed with namespace prefix to avoid name conflicts.

To describe relationships with other things, the *relations* attribute can be introduced, this attribute can have a pair format, i.e. *<relation : link to other thing>*. For example, a Zigbee temperature sensor that is controlled by a Zigbee controller 1 can be described in the following format:

“m2m:isControlled – Zigbee-Controller-1” – (example 1)

These *semanticInfo* and *relations* attributes are a subject for resource discovery so that any applications can easily discover ETSI M2M resources without any domain specific expert knowledge.

The object of *relation*, i.e. *link to other thing*, can be any type of resources. All type of things in ETSI M2M, physical thing, abstract devices and virtual things, can be used as a subject for *link to other thing*. This field should be an (absolute or relative) URI pointing to another ETSI M2M resource. In the previous example, the Zigbee controller 1 is an actual thing that exists in the ETSI M2M system. Virtual things can be used to add more semantic information to the actual things.

For example, if a sensor is deployed in a room-1, semantic annotation between the sensor and the room-1 can add semantic information about the location. In this example, room-1 is not a physical object but a virtual thing. Through annotating the relationship between the sensor and room-1, user can discovery the sensor when asking sensors in the room-1. The relationship can be described in the following format:

“m2m:isDeployed – room-1” – (example 2)

A new semantic information can be easily created, updated and deleted through using ETSI M2M supported Restful commands, CREATE, UPDATE and DELETE, respectively. In order to avoid name conflicts between vocabularies used in *semanticInfo* and *relations*, namespace prefix and the namespace URI are also defined. For example, *isDeployed* could be defined differently in two different domains: *sns:isDeployed* and *m2m:isDeployed*. This means that other could define *isDeployed* with other namespace prefix. If semantic information is provided together with this namespace prefix, a reader could be able to understand that they are different semantic information even though they have the same name.

The namespace URI can also be introduced as an attributed. The following figure shows how *semanticInfo*, *relations* and *namespaceURI* can be expressed within the ETSI M2M resource tree. In this case, *<namespaceURIs>* contains a list of namespace URIs. For example:

```
<m2m=http://www.m2m-semantic.org/sensor#>  
<sns=http://www.homeautomation.org/sensor#>
```

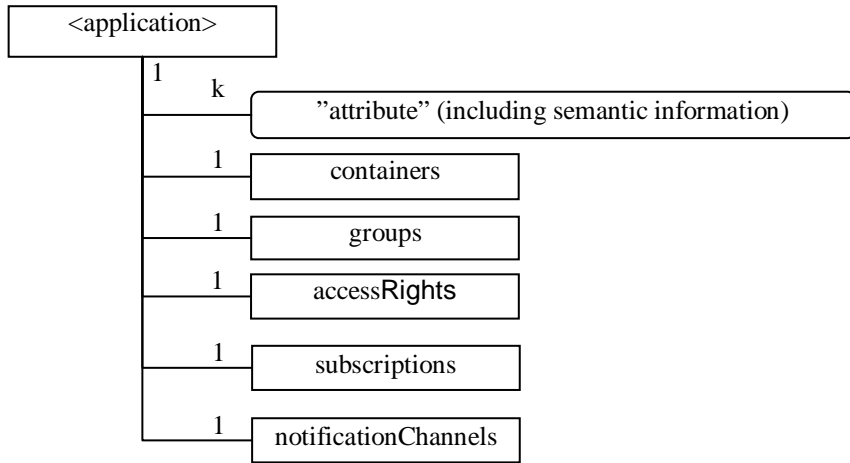

Figure 13: An example of Namespace URI as part of a sub-resource of the application resource

The attributes used for annotating semantic information are described in the following table.

Name	Description
semanticInfo	This attribute contains the semantic description of the thing. This ontology shows what is the meaning of the thing.
Relations	This attribute is used to describe the relationships with other things. This attribute can have a pair format, i.e. <relation : link to other thing>. For example, if a zibgee sensor is controlled by a Zigbee controller #1, <m2m:controlledBy – URI to Zigbee controller #1> can be a way of expressing a relationship to Zigbee controller.
namespaceURIs	This attribute is used to describe namespace URIs. This attribute contains the information about namespace prefix and the namespace URI. For example, the m2m namespace with the URI http://www.etsi-m2m.org can be expressed as follows: m2m=http://www.etsi-m2m.org/sensor#

Table 4: Attributes for annotating semantic information

Now semantic information of resources is stored in the ETSI M2M system. However, since legacy M2M systems do not support semantic queries, such as SPARQL, they need to provide a way to deliver semantic queries to the ETSI M2M system. For this purpose, the semantic M2M system should provide a capability to provide a unified access point of a semantic query to M2M applications.

When a semantic query is arrived at the semantic engine, it parses the query and generates RESTful sub-queries. The engine then processes the RESTful queries and gets resources from SCLs. The returned resources are checked for semantic information.

7.2.1.3 Semantic Mashups for Virtual Things

In the domain of Web Service, mashup is a method composing web data from more than one web resources to create a new service. Examples include metacrawlers that blends web search results from multiple search engines and news aggregators that aggregate integrated web contents in a single location. Similarly, the mashup technique can be used to create a new M2M resource in the M2M System.

In the M2M System, a M2M application can publish “virtual things” that act similar to physical resources and provide new information such as: number of vehicles that passed during the last minute/hour, average speed of vehicles, etc. These “virtual things” can be searched and discovered in the M2M System same as other M2M resources. However, in contrast to the physical things, virtual things are only implemented as software and do not require a network connectivity.

When a new virtual thing is registered (or published) to the M2M system, a list of member M2M resources is stored together as an attribute of the thing. If the virtual thing collects information dynamically at the time of receiving a query, a pre-programmed query that collects member resources is also stored along with other information.

Once a virtual thing is added to the NSCL, it is handled and processed the same as all other M2M resources. This means that virtual things are exposed to M2M applications to be discovered. An example of the semantic virtual mashup process is shown in the following Figure 14:

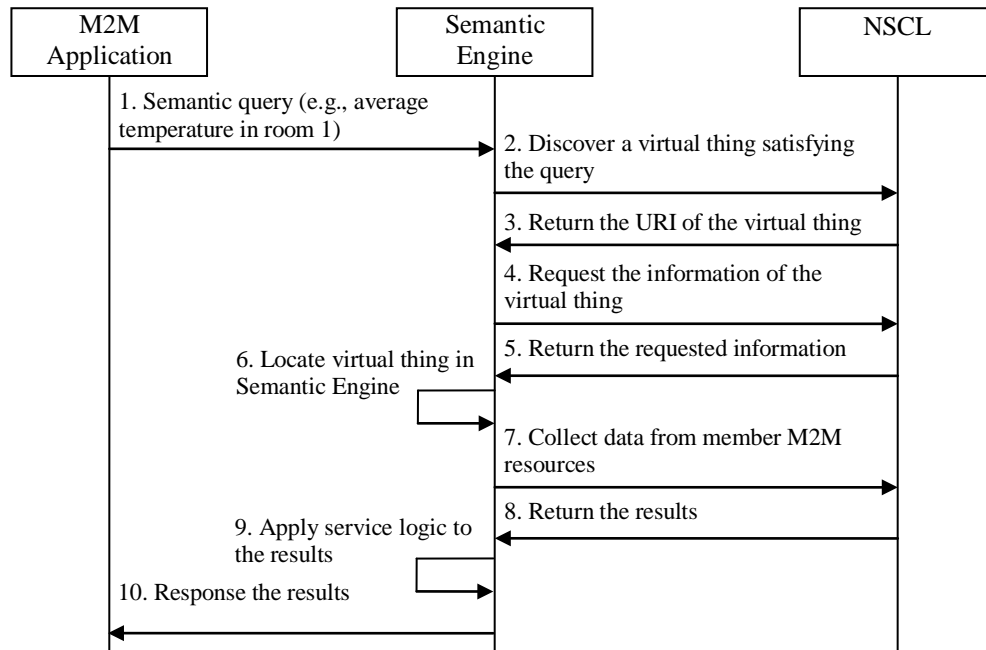

Figure 14: Semantic virtual mashup procedure

Step 1: M2M application sends a semantic query to the M2M system, for example, “Get the temperature of the room 1”.

Step 2: semantic engine handles this like a normal semantic query so that sends a discovery request to the NSCL.

Step 3: the NSCL returns the URI of a virtual thing that provides the temperature of the room 1.

Step 4: semantic engine sends a request to the NSCL to retrieve the information of the virtual thing, i.e., service logic, mashup type (either static or dynamic) and pre-programmed queries.

Step 5: the NSCL returns the requested information.

Step 6: semantic engine instantiates the virtual thing. For a virtual thing that is frequently requested, it can be cached in semantic engine and handles the request directly.

Step 7: the virtual thing at semantic engine collects required data from its member resources using the pre-programmed query.

Step 8: the NSCL returns the results from member resources

Step 9: the virtual thing applies its service logic (e.g., calculating the average value) to the received data and calculates the results.

7.2.2 Introduction to OGC Sensor Web Enablement

7.2.2.1 Overview

A sensor Web simply refers to web accessible sensor networks for enabling an interoperable usage of sensor resources by enabling Web-based discovery, access, tasking and alerting using standard protocols and application program interfaces (APIs). It enables the advancement of Web applications through improved situation awareness.

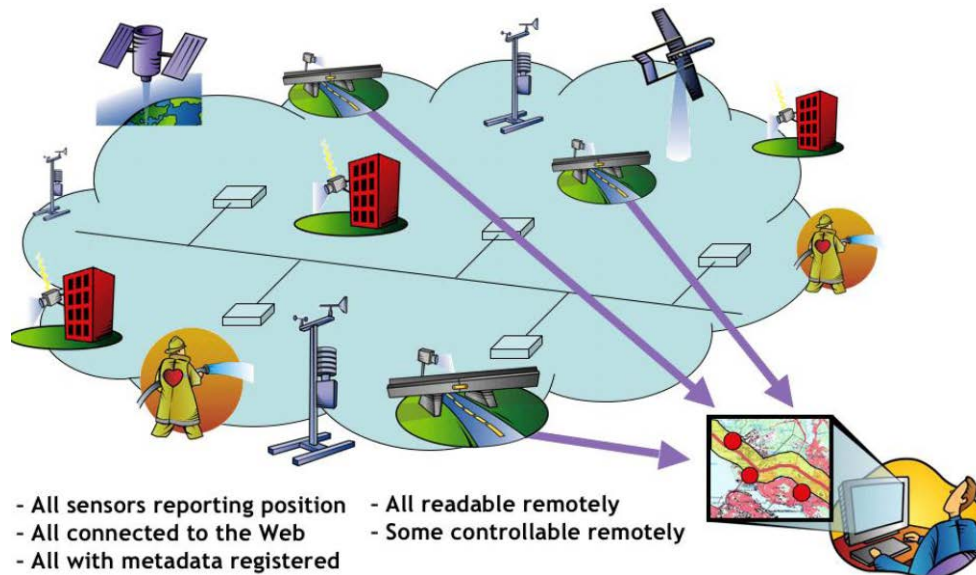

Figure 15: Sensor Web Concept

The Open Geospatial Consortium (OGC) [i.3] has worked to specify interoperability interfaces and metadata encodings that enable real time integration of heterogeneous sensor Web into the information infrastructure. The OGC has developed publicly available encoding and interface standards. These standards can be used so that developers create applications, platforms, and products involving Web-connected devices so as to make complex spatial information and services accessible and useful with all kinds of applications.

The Sensor Web Enablement (SWE) [i.4], a suite of web service interfaces and communication protocols, presents many opportunities for adding a real-time sensor dimension to the Internet and the Web as a unique and revolutionary framework of open standards for exploiting Web-connected sensors and sensor systems of all types. This has extraordinary significance for various vertical applications and services in M2M domains.

7.2.2.2 Sensor Web Enablement (SWE) Languages

The models, encodings, and services of the SWE architecture enable implementation of interoperable and scalable service-oriented networks of heterogeneous sensor systems and client applications. The OGC's SWE initiative has focused on developing standards to enable the discovery, exchange, and processing of sensor observations, as well as the tasking of sensor systems. The functionality that OGC has targeted within a sensor Web includes [i.5]:

- Discovery of sensor systems, observations, and observation processes that meet an application's or user's immediate needs
- Determination of a sensor's capabilities and quality of measurements
- Access to sensor parameters that automatically allow software to process and geo-locate observations
- Retrieval of real-time or time-series observations and coverage in standard encodings tasking of sensors to acquire observations of interest
- Subscription to and publishing of alerts to be issued by sensors or sensor services based upon certain criteria.

In SWE, the OGC has made a framework of open standards for exploiting Web-connected sensors and sensor systems of all types. This framework is called a Sensor Web, and refers to web accessible sensor networks and archived sensor data that can be discovered and accessed using standard protocols and APIs. SWE is composed of three languages and four service specifications:

- **Observations & Measurements (O&M) [i.6]:** Standard models and Extensible Markup Language (XML) schema for encoding observations and measurements from a sensor, both archived and in real time.
 - An observation is an event with a result that has a value describing some phenomenon. The observation is modeled as a feature within the context of the ISO/OGC General Feature Model. An observation feature binds the result to the feature of interest, upon which it was made. An observation uses a procedure to determine the value, which may involve a sensor or observer, analytical procedure, simulation or other numerical processes.
- **Sensor Model Language (SensorML) [i.7]:** Standard models and XML schema for describing sensor systems and processes associated with sensor observations in order to provide information required for the discovery of sensors, location of sensor observations, processing of low-level sensor observations, and listing of taskable properties, as well as supporting on-demand processing of sensor observations.
 - Within SensorML, everything including detectors, actuators, filters, and operators are defined as process models. A Process Model defines the inputs, outputs, parameters, and method for that process, as well as a collection of metadata useful for discovery and human assistance. The inputs, outputs, and parameters are all defined using SWE Common data types. Process metadata includes identifiers, classifiers, constraints (time, legal, and security), capabilities, characteristics, contacts, and references, in addition to inputs, outputs, parameters, and system location.
- **Transducer Model Language (TransducerML or TML) [i.8]:** A conceptual model and XML schema for describing transducers and supporting real-time streaming of data to and from sensor systems.
 - TML defines:
 - A set of models describing the hardware response characteristics of a transducer.
 - An efficient method for transporting sensor data and preparing it for fusion through spatial and temporal associations.
- **Sensor Observations Service (SOS) [i.9]:** A standard Web service interface for requesting, filtering, and retrieving observations and sensor system information as the intermediary between a client and an observation repository or a near real-time sensor channel.
 - The SOS includes three core operations:
 - The GetObservation operation provides an interface to query over observation data and returns an O&M document.
 - The DescribeSensor operation provides an interface to query for the description of a sensor and returns a SensorML document.
 - The GetCapabilities operation provides an interface to query for the description of a SOS. GetCapabilities allows clients to retrieve service metadata about a specific service instance and returns a GetCapabilities response document.
- **Sensor Planning Service (SPS) [i.10]:** A standard Web service interface for requesting user-driven acquisitions and observations as the intermediary between a client and a sensor collection management environment.
- **Sensor Alert Service (SAS) [i.11]:** A standard Web service interface for publishing and subscribing to alerts from sensors.
- **Web Notification Services (WNS):** A standard Web service interface for asynchronous delivery of messages or alerts from SAS and SPS Web services and other elements of service workflows.

The OGC SWE standards became a basis for the World Wide Web Consortium (W3C) Semantic Sensor Network (SSN) - Incubator Group (XG) [i.12] to study and recommend methods for using the ontology to semantically enable applications through the extension of the SensorML for supporting semantic annotations.

As the OGC has identified the need for standardized interfaces for sensors in the Web of Things (WoT), the OGC has created a new Standards Working Group (SWG) on the sensor Web interface for the Internet of Things (IoT). The

sensor Web interface for the IoT SWG [i.13] aims to develop such a standard based on existing WoT portals with consideration of the existing OGC SWE standards. This group is developing a candidate standard for access to sensor observations including location information well-suited to IoT and WoT deployment environments.

7.2.2.3 Semantic annotations in OGC standards

Introducing annotation

In the OGC Best Practice [i.14], the OGC has introduced the notion of **semantic annotation**.

NOTE – Annotation of Web Services or data compliant to OGC standards refers to the task of attaching meaningful descriptions to the service and the served geospatial data or processes. The OGC has extended the expressiveness of such annotations by including **more sophisticated (semantic) descriptions**.

Semantic annotations enable data providers to connect the standardized service descriptions to the modeled knowledge. Semantic annotations establish a connection between the geospatial resource, its metadata, and the ontology. Figure 16 illustrates the three different levels of (semantic) annotations which are possible for OGC Web Services.

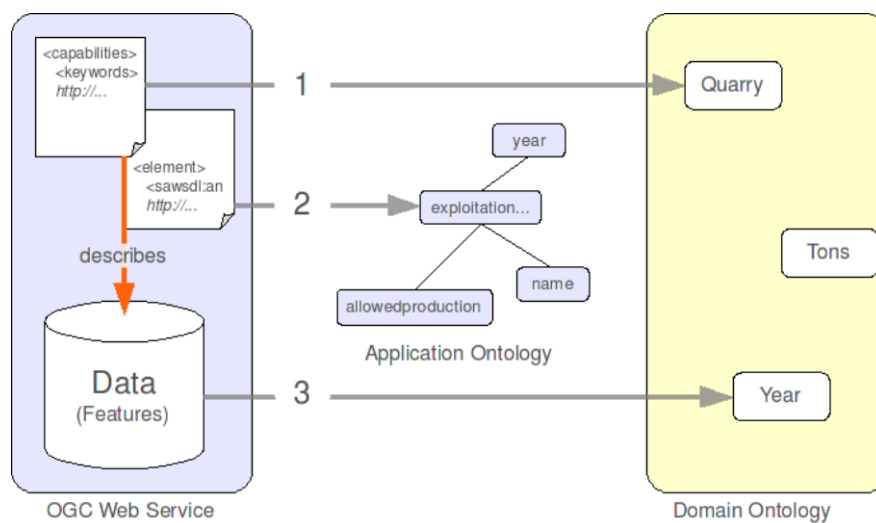

Figure 16: Semantic annotations at three different levels

It is possible to distinguish between three locations where particular information about the resource can be acquired.

- *The first source of information:* the Capabilities-document which comprises functional properties telling the user how to access and invoke the service, as well as some resource **metadata** with information about the service provider, licensing, a title and description, or a keyword section.
- *The second source of information:* a XML-based schema representing the **data model**, which comprises a description of the data model with focus on syntax and structure.
NOTE – The **metadata** and the **schema** are describing the underlying data, and therefore explicitly linked (the orange arrow in Figure 16).
- *The third source of information:* the **data entities** itself, encoded in the format predefined in the data model specified in the data schema.

There are two types of references (see Figure 17):

- **Domain reference:** links between a local, application-specific model and a global, shared vocabulary. It can be also expressed in form of complex rules.
- **Model reference:** bridge different languages. It is always a link between two models (e.g., XML Schema or UML modelling data, RDF modelling a domain vocabulary, and so on) and a unique URI which points to the corresponding element in another model.

NOTE – The two types of references can overlap. In many cases a domain reference is in the same time also a model reference, since the reference performs both tasks (bridging in between two languages and linking from local to global). In this case, the domain reference should be used.

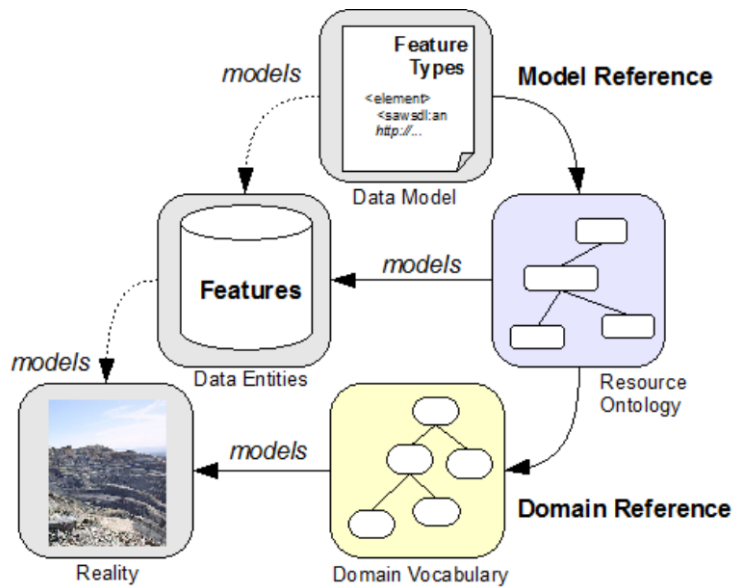

Figure 17: Two types of references

Semantic annotations at three different levels

Modeling knowledge and publishing it in a well-defined and machine interpretable format can result in increased usability of OGC Web Services. OGC considers ontologies as most promising format to capture such knowledge. But the possibilities to connect ontologies with OGC services are manifold. The followings discuss how we can annotate OGC services on the already mentioned three levels:

- **Level 1 - The service metadata**

- Adding knowledge model references in one of the existing sections in the **data** and/or **services metadata** (e.g., by extending the keyword section of OWS Capabilities) as the most pragmatic and still useful approach

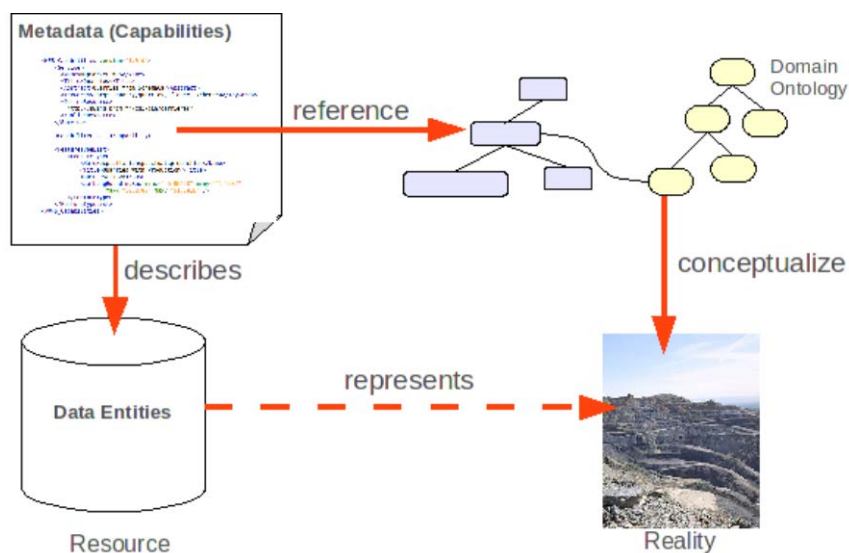

Figure 18: Annotations as part of the resource metadata

- **Level 2 - The data models and process descriptions**

- Semantic annotation on the **data models** and the **service operations** in order to relate service metadata more efficiently to domain knowledge. Considering data structures (e.g., Geography

Markup Language (GML [i.15] application schema) for semantic annotations enables reasoning on data model level.

NOTE – The GML is an XML grammar for expressing geographical features.

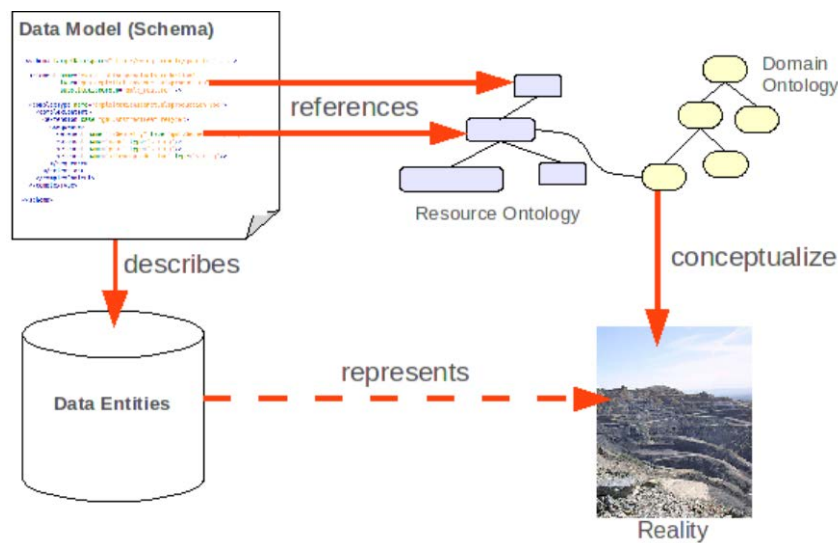

Figure 19: Referencing elements in the data model to domain ontologies

- **Level 3 - The actual data instances in the database**
 - Semantic annotations are also possible on the **data entity** level (e.g., GML features and feature attributes in OGC Web Service)

The three annotations levels differ in their potential. This is due to different reasoning capabilities, i.e. the abilities to infer either new knowledge (making implicit knowledge explicit) or to identify conflicts in existing models. Accordingly, the applications for semantically supported OWS discovery and workflow validation vary.

7.2.3 Introduction to W3C Semantic Sensor Network Ontology

7.2.3.1 Overview

The World Wide Web Consortium (W3C) **Semantic Sensor Network (SSN) - Incubator Group (XG)** [i.16][i.17] had worked on two main objectives: 1) to develop an ontology to describe sensors and sensor networks, and 2) to study and recommend methods for using the ontology to semantically enable applications through the extension of the Sensor Model Language (SenosrML) [i.18] developed in the Open Geospatial Consortium (OGC) [i.19] for supporting semantic annotations.

The W3C SSN-XG had recognized that several Sensor Web Enablement (SWE) [i.20] standards developed by the OGC should be replaced by approaches based on the semantic Web languages developed by W3C. Furthermore, the group were also motivated the fact that the development of ontologies and of mechanisms to support semantic annotations for sensors could improve interoperability and integration of various services with enhanced capabilities such as reasoning and automation.

For developing an ontology, the W3C SSN-XG considered the following two axes for identifying a set of use cases: 1) various users who use and manipulate data as well directly manage sensor and sensor networks, and 2) technical evolution toward the integration of sensor Web and semantic Web. The following provides four groups of use cases identified for the modeling of sensors in the group:

- **Data discovery and linking** to find all observations that meet certain criteria, and possibly link them to other external data sources.
- **Device discovery and selection** to find all the devices that meet certain criteria.

- **Provenance and Diagnosis** to provide extra information about the instrument to better evaluate or process the data.
- **Device Operation Tasking and Programming** to command a device's operation using its description and information on its conditions of use.

Based on use cases, the W3C SSN-XG had developed the ontology (called **SSN ontology**, see the Section 7.2.3.2) which provides a high-level schema to describe sensor devices, their operation and management, observation and measurement data, and process related attributes of sensors. The SSN ontology supports a domain-independent and end-to-end model for sensing applications, and it can be used with domain ontologies and other ontologies to model the observation and measurement data produced by the sensors. For ontology specification, Web Ontology Language Description Logic (OWL DL) was selected to encode sensor descriptions considering mapping between the ontologies and OGC models.

7.2.3.2 The Semantic Sensor Network Ontology

Introduction

Before starting the work on the SSN ontology, the W3C SSN-XG extensively reviewed ontologies and data models describing sensors and their capabilities as well as observation, using attributes [i.21]. After reviewing them, the group identified that there are important concepts that should be included, but found that none of the existing ontologies supported all of those required concepts. Therefore, the group started to newly develop a formal OWL DL ontology for modeling sensor devices (and their capabilities), systems and processes.

NOTE – The Section 4 in [i.17] provides details reviewed sensor ontologies and observation ontologies as well as surveys of various ontologies.

For describing the physical and processing structure of sensors, the ontology is based around concepts of systems, processes, and observations. There had been considered various kinds of sensors (e.g., a device, computational process or combination) including typical physical sensing devices and anything for estimating or calculating the value of a phenomenon. The representation of a sensor in the ontology links the followings: 1) what it measures (the domain phenomena), 2) the physical sensor (the device) and 3) its functions and processing (the models).

NOTE – The ontology is available as a single OWL file: SSN ontology [i.22] and a semi-automatically generated documentation [i.23] derived from it is also provided as a standalone document.

NOTE – In the Section 5 in [i.17], there are five worked examples to illustrate different parts of the SSN ontology: University deployment, Smart product, Wind sensor, Agriculture Meteorology, and Linked Sensor Data.

Ontology structure

The SSN ontology revolves around the central Stimulus-Sensor-Observation pattern.

NOTE – The Stimulus-Sensor-Observation Ontology Design Pattern aims at all kind of sensor or observation based ontologies and vocabularies for the Semantic Sensor Web and especially Linked Data.

- **Stimuli:** detectable changes in the environment (i.e., in the physical world).
- **Sensors:** physical objects that perform observations (i.e., they transform an incoming stimulus into another, often digital, representation).
- **Observations:** act as the nexus between incoming stimuli, the sensor, and the output of the sensor (i.e., a symbol representing a region in a dimensional space).

Several conceptual modules (see Figure 20) build on the pattern to cover key sensor concepts. Figure 21 which shows the relationships between modules contains an overview of the main classes and properties inside the ontology modules.

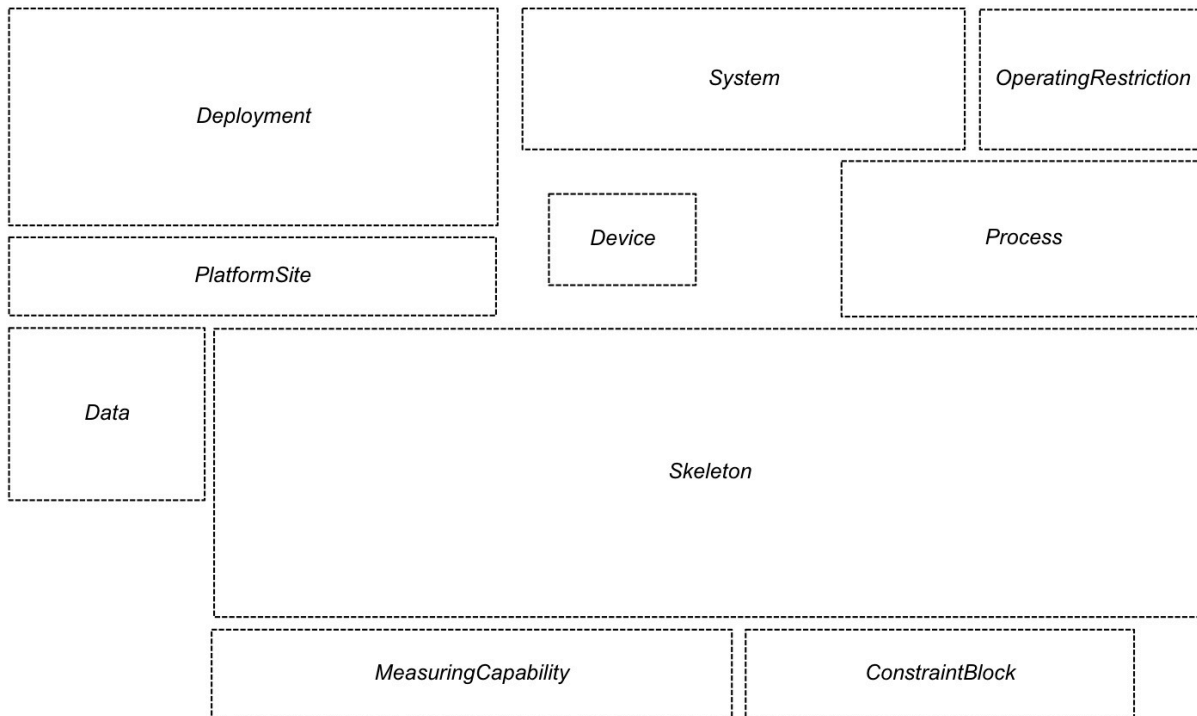

Figure 20: Overview of the Semantic Sensor Network ontology modules

The ontology can be used for a focus on any (or a combination) of a number of perspectives:

- **Sensor perspective:** what senses, how it senses, and what is sensed.
- **Data or observation perspective:** observations and related metadata.
- **System perspective:** systems of sensors.
- **Feature and property perspective:** features, properties of sensors, and what can sense those properties.

The modules allow further refining or grouping of these views on sensors and sensing. The description of sensors may be detailed or abstract. The ontology does not include a hierarchy of sensor types.

NOTE – Domain experts can define further details. Thus, the ontology could be a simple hierarchy or a more complex set of definitions based on the workings of the sensors.

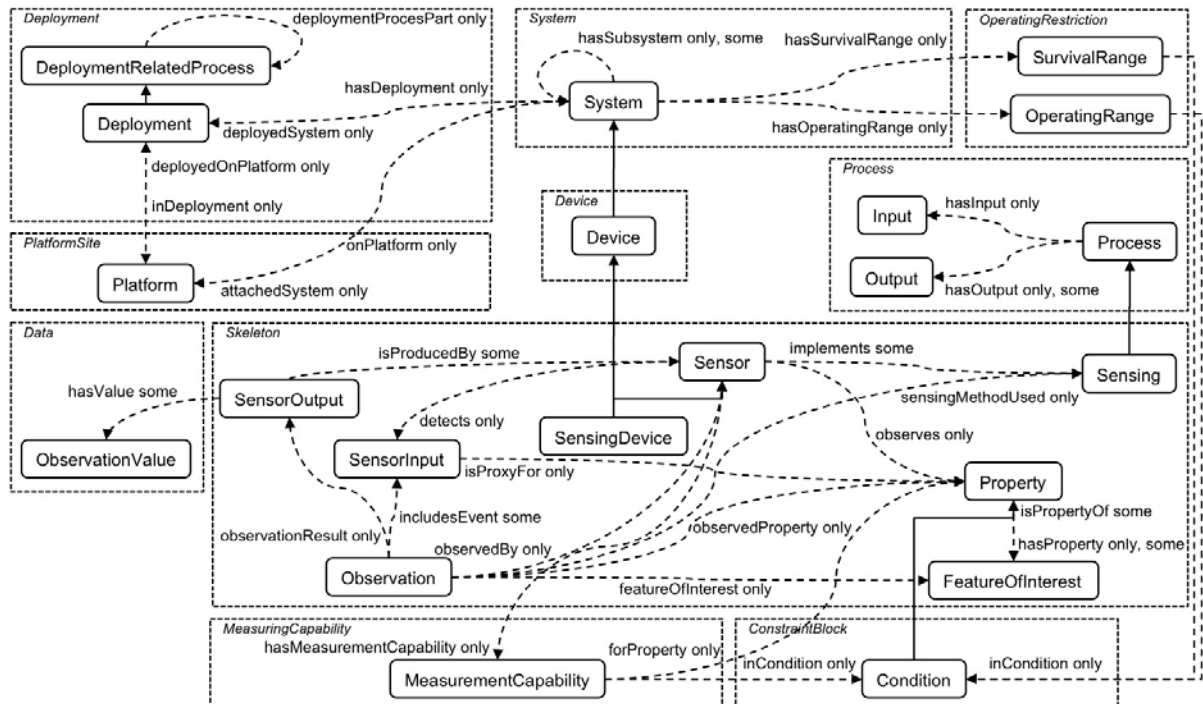

Figure 21: Overview of the Semantic Sensor Network ontology classes and properties

The modules contain the classes and properties that can be used to represent particular aspects of a sensor or its observations: for example,

- Sensors
- Observations
- Features of interest (i.e., entities in the real world that are the target of sensing)
- The process of sensing (i.e. how a sensor operates and observes)
- How sensors are deployed or attached to platforms
- The measuring capabilities of sensors
- Their environmental, and survival properties of sensors in particular environments

Figure 22 shows a detailed enumeration of these properties.

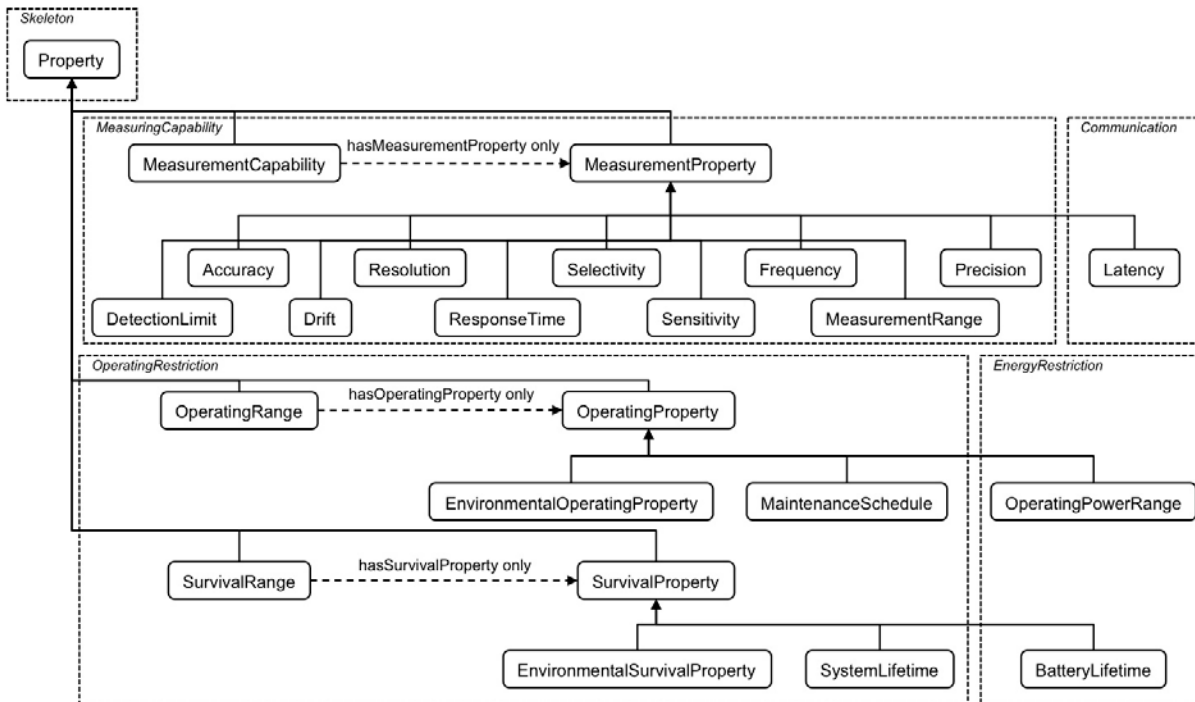

Figure 22: Enumeration of the measurement, environmental and survival properties

The main classes of the SSN ontology have been aligned with classes in the DOLCE Ultra Lite (DUL) foundational ontology to facilitate reuse and interoperability [i.24]. Figure 23 shows in blue arrows the subclass properties used to align these two ontologies.

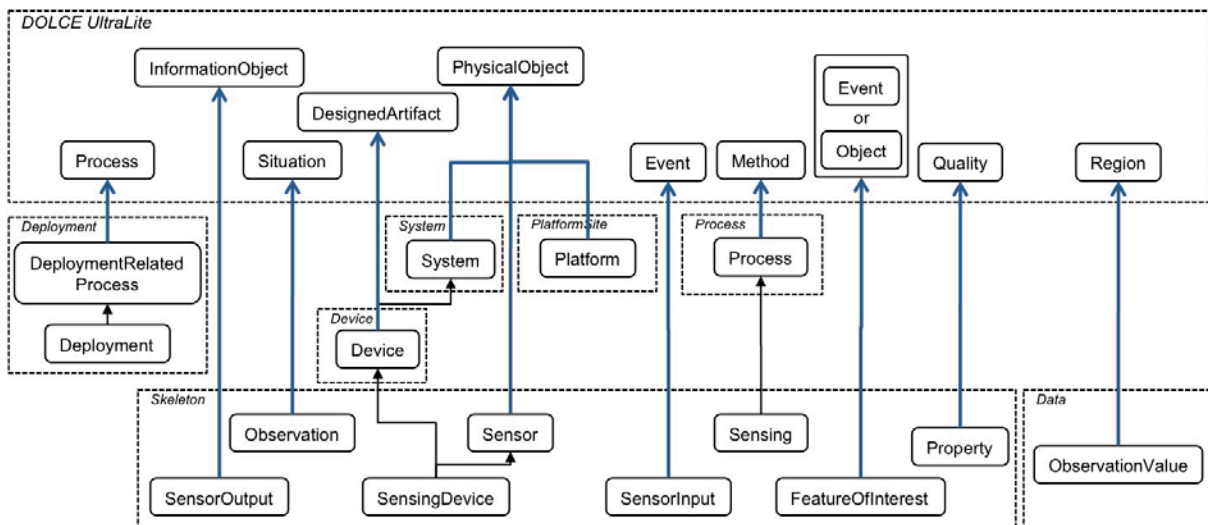

Figure 23: Alignment of the Semantic Sensor Network ontology to DOLCE Ultra Lite

Finally, Figure 24 shows how the ontology modules defined above support the use cases described in the Section 7.2.3.1.

- Orange color users developing Semantic Sensor Web applications: more specifically interested in the modules connected to the Data Discovery and Linking and Provenance and Diagnosis uses cases.
- Green color users developing Semantic Sensor Web applications: need the modules connected to the Device Discovery and Selection and Device Operation Tasking and Programming uses cases.

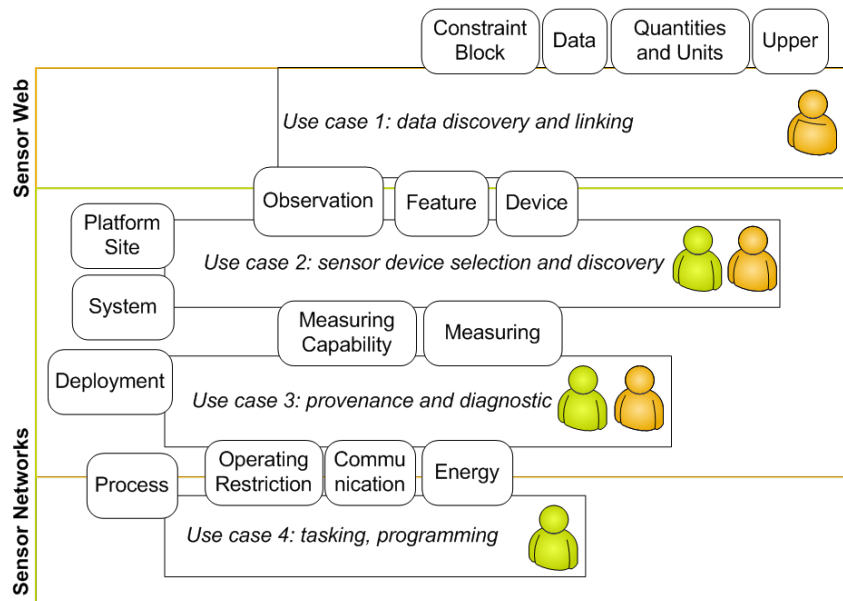

Figure 24: Use cases and ontology modules

7.3 Key Issues on Standardising Semantics and Ontologies

7.3.1 How to share common understanding of the structure of information among m2m nodes?

For example, suppose several different Home Automation Systems contain temperature information or provide Energy Saving applications. If these applications share and publish the same underlying ontology of the terms they all use, then applications can extract and aggregate information from these different applications.

oneM2M has to provide a solution for the following issues:

- Should oneM2M provide the ontology for a specific domain or verticals?
 - ⇒ Maybe 'YES' for the oneM2M common service layer domain but in general 'NO'. oneM2M needs to provide a means for sharing pre-defined or existing ontologies.
- Other issues are FFS.

7.3.2 How to enable the reuse of domain knowledge?

For example, many different domains need to represent time in their model. This representation includes the notions of time intervals, points in time, relative measures of time, and so on. If one vertical develops such an ontology, others do not need to develop another ontology but can simply reuse it for its domain.

Additionally, if oneM2M or a vertical need to build a large ontology, several existing ontologies can be integrated for the large domain.

oneM2M has to provide a solution for the following issues:

- How to integrate several ontologies in order to build an integrated large ontology
- How to import (or reference) ontologies defined outside of oneM2M

7.3.3 How to enable evolving ontologies?

Ontologies should be changed easily over the time if the knowledge about a domain changes. oneM2M should consider flexibility when designing ontologies or importing external ontologies.

7.3.4 How to analyse domain knowledge (ontologies)?

Ontology itself is a means for developing semantic M2M systems. Developing an ontology is a process for defining a set of semantic concepts and the relationships between concepts. For example, let us consider that there is an ontology of home appliances (such as refrigerator and washing machine). This ontology can then be used as a basis for some M2M applications in energy savings: One application could create suggested schedules for the home appliances during the day in order to save energy. Another M2M application could analyse available home appliances and suggest which appliances are to be replaced.

oneM2M has to provide a solution for the following issues:

- What platform mechanisms are needed to support such analyses?

7.3.5 How to make semantic annotations?

As described in Section 7.1.2.6, “semantic annotation” of M2M resources is a method for adding semantic information to M2M resources. Semantic annotations can be used as a basis to provide consistent data translation and data interoperability to heterogeneous M2M applications.

Since oneM2M represents M2M resources as a tree structure, methods for adding semantic information to corresponding M2M resources have to be standardized. (NOTE. Typically semantic information is represented using RDF or OWL).

oneM2M has to provide a solution for the following issues:

- A method for annotating the oneM2M architecture resource tree with semantic information.
- A solution showing how to describe semantically annotated M2M resource using RDF or OWL.

7.3.6 How to generate (or register) new M2M resources/applications based on existing M2M resources/applications?

According to the definition in Section 7.1.2.5, “semantic mash-up” is a functionality to support new services through the creation of new virtual devices, which do not exist in the physical world, by obtaining semantic information through semantic descriptions from existing M2M resources in the M2M System.

oneM2M has to provide a solution for the following issues:

- How can new virtual devices be created?
- Which attributes and resources does a virtual device have to include.
- What is the life-cycle of a virtual device and what are the relationships with other M2M resources out of which the virtual device is composed.
- How to define the role of virtual devices?
- What are the impacts to existing ontologies?

7.3.6 How make reasoning?

As described in Section 7.1.2.2, “reasoning” is a mechanism to derive new implicit knowledge from semantically annotated data based on a set of asserted facts or axioms. For example, if the semantic annotation of resource “R” indicates that “R” is an instance of class “A”, and the referenced ontology indicates that “A” is sub-class of “B”, then using “reasoning” can derive that “R” belongs to class “B”.

In practice, the semantic annotation of resources and the semantic query request from applications may use different vocabularies in same ontologies or different ontologies, e.g. the semantic annotation for a blood pressure monitor indicates that it is an instance of “blood pressure monitor” and its “precision” is “high”, while the semantic query requests may use a different vocabulary “advance blood pressure monitor” which is sub-class of “blood pressure monitor” defined as “blood pressure monitor” with “high” “precision”. Without “reasoning”, M2M applications may not be able to correctly find target M2M resources via semantic query.

oneM2M has to provide a solution for the following issues:

- Should reasoning function of semantic engine be provided in oneM2M systems?

Maybe “YES” since it is too complicated for applications to only use basic concepts with multiple logical rules as filter in each semantic query request.

- Should reasoning function of semantic engine update the semantic annotation information based on reasoning results?

Maybe “YES” since updating semantic annotation information via reasoning could improve the speed of semantic query.

- Should reasoning function of semantic engine be able to provide reasoning among multiple compatible ontologies?

- Should reasoning function of semantic engine only be triggered along with semantic query process

Maybe “NO” since data analytics may also need the assistants of reasoning function of semantic engine.

- How to trigger reasoning function of semantic engine?

7.3.7 How to enable semantic rule ?

In general, ontologies concentrate on classification methods, putting an emphasis on defining 'classes', 'subclasses', on how individual resources can be associated to such classes, and characterizing the relationships among classes and their instances.

Semantic Rules, on the other hand, concentrate on defining a general mechanism on generating new relationships based on existing concepts and relationships in ontologies using logical manners. Typical formats for representing semantic rules include RIF [i.38], SWRL [i.39] and SPIN [i.40], which are all compatible with RDF and OWL.

Compared with ontologies, semantic rules can be exchanged locally and temporarily, so using semantic rules can facilitate defining dynamic or private relationships. For example, an M2M application can exchange one semantic rule with the semantic engine in M2M platform, and the semantic engine will use this semantic rule only for processing the request from that M2M application. It is very flexible. In addition, the semantic rules can also be used to associate the concepts in multiple different ontologies.

oneM2M has to provide a solution for the following issues:

- Should semantic rule be supported in oneM2M systems?

- Maybe “YES” since it is more flexible than only using ontologies, e.g. applications can dynamically define new relationships according to their own requirements via using semantic rules, which do not need to revise ontologies.

- Should reasoning function of semantic engine support the reasoning simultaneously with semantic rules and ontologies?

- How do semantic rules be exchanged in oneM2M systems ?

7.4 Specific potential requirements for semantics

7.4.1 Semantics Related Requirements

7.4.1.1 Semantic Annotation Requirements

1. The M2M System shall support semantic annotation of application related data (e.g., containers) that are handled (e.g., transferred) by the M2M System.

7.4.1.2 Ontology Requirements for Semantics Support

1. The M2M System shall be described by an ontology containing the entities of the M2M System, their information models and their relationships.
2. The M2M System shall provide support for linking of the ontology describing the oneM2M System with ontologies describing other information models.
3. The M2M System will be able to support extensible ontologies with new domain concepts, in order to support newly created oneM2M Applications.
4. Ontologies used in the M2M System shall support semantic annotation in order to enable automated processing of semantic information.

NOTE: Semantic annotation in oneM2M: A method for adding semantic information to M2M resources that provides consistent data translation and data interoperability to heterogeneous M2M applications.

5. The M2M System shall be able to support the ontologies that contain entities that are not represented by resources of the M2M System.
6. The M2M System shall be able to support common ontologies (e.g., location, time ontologies, etc.) which are used commonly in M2M Applications. (Source: Section 7.3.2)
7. Requirements on integration of ontologies (Source: Section 7.3.2)
 - The M2M System shall be able to support simultaneous usage of multiple semantic ontologies for the same M2M resource.
 - The M2M System may support creation, usage, and publication of new ontologies based on semantic reasoning.
8. The M2M System shall be able to import (or reference) ontologies defined outside of oneM2M. (Source: Section 7.3.1. and 7.3.2)
9. The M2M System should be able to adapt to changes of ontologies defined within or outside the M2M System, preferably without human interaction. (Source: Section 7.3.3)

8 Support for Abstraction and Semantics in oneM2M

8.1 Summary of Requirements

Requirement	Description	Release
-------------	-------------	---------

ID		
ABR-001	The M2M system shall provide a generic structure for data representation.	
ABR-002	The M2M system shall be able to provide translation mechanisms among Information Models (including meta-data) used by M2M Applications, M2M Devices/Gateways, and other devices.	
ABR-003	The M2M System shall provide capabilities to represent Virtual Devices and Things, (which are not necessarily physical devices.)	
SMR-001	The M2M System shall provide capabilities to manage semantic descriptions of resources and M2M Applications, e.g. create, retrieve, update, delete, associate/link.	
SMR-002	The M2M System shall support a common modeling language for semantic descriptions (including relationships between Things) in order to make them available to M2M Applications.	
SMR-003	The M2M System shall be able to provide interworking capabilities between different modeling languages for semantic descriptions.	
SMR-004	The M2M System shall provide capabilities to discover M2M Resources based on semantic descriptions.	
SMR-005	The M2M System shall support the capability to access semantic descriptions which are outside of the M2M System.	
SMR-006	The M2M System shall be able to support capabilities for performing M2M data Analytics based on semantic descriptions from M2M Applications and /or from the M2M System.	
SMR-007	The M2M System shall be able to provide capabilities for performing Semantic Mash-up using M2M data from M2M Applications and/or from the M2M System (e.g. to create Virtual Devices, offer new M2M Services, etc.)	

8.2 Modeling aspects for abstraction and semantics in oneM2M

8.2.1 Overview of modelling aspects

In Release 1, the oneM2M System enables applications to interact with each other using opaque, application specific containers, based on the resource concept. In order to enable interaction between applications that use similar data (e.g. temperature) but employ different encoding for these data a common abstraction layer can be built that provides services to convert the data into a abstracted, common format. With such an abstraction layer, regarding communication, application developers do not have to consider the underlying heterogeneity of their communication partners as this is abstracted away. However, applications in most cases still need to know a priori their communication partners as the Rel-1 discovery functionality is very limited and does not allow discovering other applications based on their semantics, e.g. the services they support. Data is treated as a black box without providing information about its structure and semantics. Thus this information needs to be known in advance by the respective applications and cannot be discovered. For a more flexible system that allows the reuse of information and functionality by different applications the structure and semantics of application data exchanged in the oneM2M System can be made explicit. Providing common abstractions not just for the purpose of interaction, but also for sharing information about the provided functionality is one aspect of it.

M2M allows applications to extend their reach into the physical world. Devices enable the sensing of, as well as the actuation on relevant aspects of the physical world. The physical world is populated by Things in a broad sense,

including buildings, rooms, windows, roads, bottles etc. Ultimately, the applications interact with these Things, using the Devices for mediating this interaction. Figure 25 shows the underlying domain model.

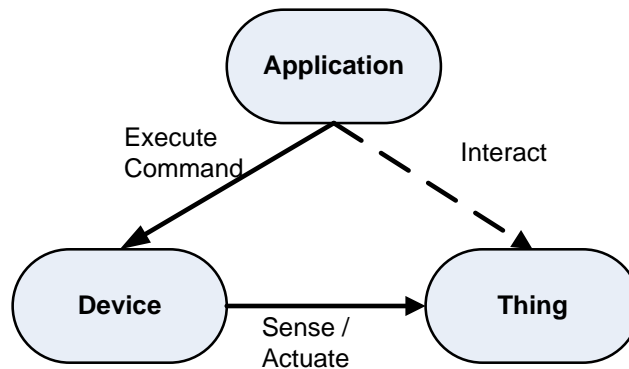

Figure 25: Domain Model

Whereas the oneM2M Services are directly involved in the communication between application and Device, they nevertheless should model and provide support for real-world aspects as ultimately M2M is about supporting a mediated interaction between the applications and Things.

In the following subsections we want to further discuss how Devices and Things can be modelled in an appropriate way, how they can be represented and how the respective models can be used in future releases of the oneM2M System.

8.2.2 Modelling of Devices and Things

8.2.2.1 Modelling of Concepts

In this subsection, we introduce some more details for the identified key concepts Device and Thing. These details are emphasized as they are needed for enabling functionalities that are proposed for being supported by the oneM2M System. First, only the most basic structure for modelling Devices and Things is described.

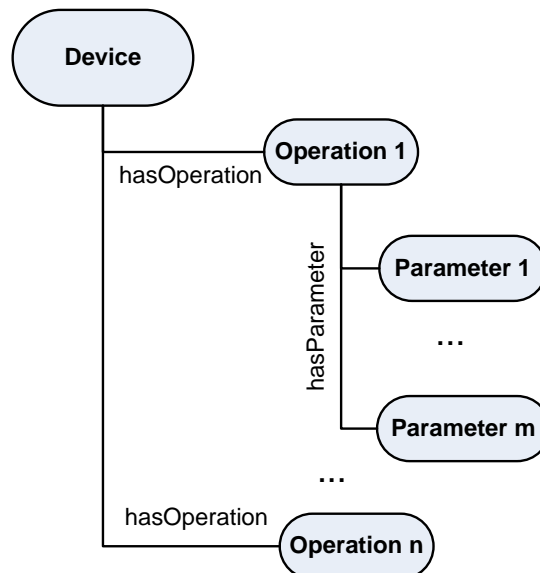

Figure 26: Device Structure

Figure 26 shows some key information about describing Devices. Devices support different Operations, Operations have different Parameters that can be used for input or output purposes. The structure is the basis for defining specific Device Types and successively Operation and Parameter Types. The specific Device Types together with the

Operations they support etc. can be defined by other, e.g. application area-specific, standardization organizations. For oneM2M, it is important that they follow the structure as the structure can then serve as the basis for creating the resource representation for Device Instances of the given Device Type.

To support other aspects of Devices more relations and concepts have to be added. For example, the identifier(s), the producer, the energy consumption may be needed for other purposes, e.g. discovery. To keep the complexity of the presentation of the modelling *approach* simple, we focus on the Operations and Parameters that are needed for defining the oneM2M resource structure.

It should be noted that the above structure for describing Devices in terms of their Operations can be used for any type of Device, whether oneM2M Device or other Device that is interworked with the oneM2M System. This structure does, however, not yet take into account more detailed aspects of modelling Devices, e.g. direction of information flow etc.

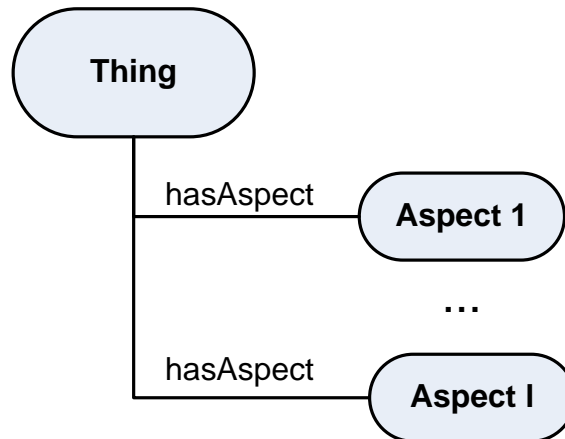

Figure 27: Thing Structure

Figure 27 shows some key information about Things. Basically Things have different Aspects, e.g. a room can have a size, a height, a temperature, a noise level etc. These Aspects can be related to Devices that provide information, e.g. the current noise level, or they can influence it like the current temperature in case the Device is a heater or air conditioning system. Aspects can also model relations to other Things.

As in the case of Devices, the specific Thing Types together with the Aspects they have etc. can be defined by other, e.g. application area-specific, standardization organizations. For oneM2M, the underlying structure is important.

8.2.2.2 Modelling of Types

Based on the identified concepts, which define the structure, the respective types can be defined. This means, based on the previous subsection, we know that, for example, Devices have Operations and Operations have Parameters, but we do not know yet what types of Devices exist and what Operations each of these types have.

As shown in Figure 28, Device Types can be hierarchically defined. There is a common Device Super Type, and, in this example, a single Operation is defined for it, i.e. MyOperation 1. In the given example, Device Type 1 and Device Type 2 inherit from the Device Super Type, i.e. instances of these also support MyOperation 1 (shown for Device Type 1). Device Type 1 in addition introduces MyOperation 2, which is supported by all Devices of Device Type 1 and all Device Types inheriting from it. Note that Operations could be mandatory or optional.

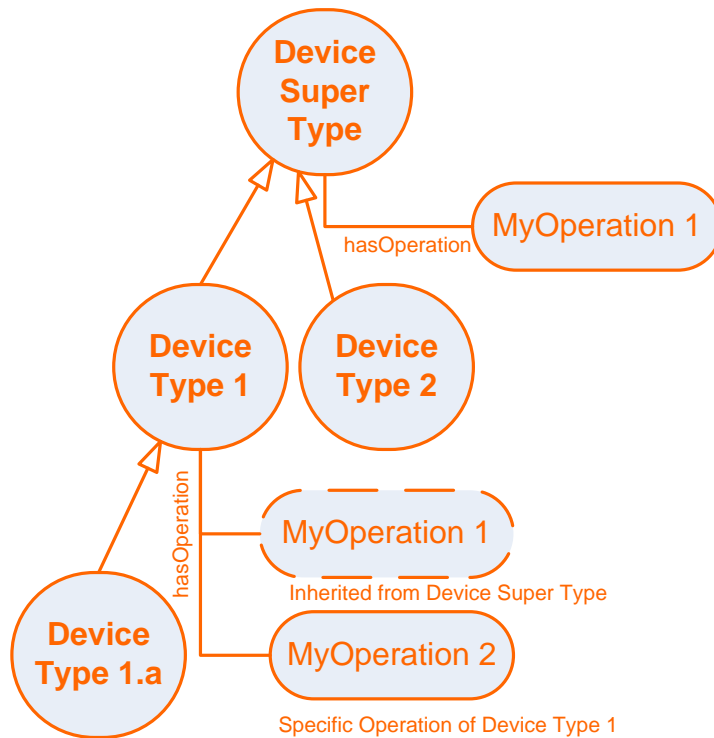

Figure 28: Example of Device Types and their Operations

The Operations again have a structure, which is defined in an Operation Type hierarchy as shown in Figure 29. So, for example, My Operation 1 could be of Operation Type 2 and My Operation 2 could be of Operation Type 1. Operation Types define what Parameters they have, which again would have Parameter types. Parameter Types (sketched with dashed lines) follow exactly the same approach as Device Types and Operation Types and can build type hierarchies. Parameter types include the specification of the data type of the parameter.

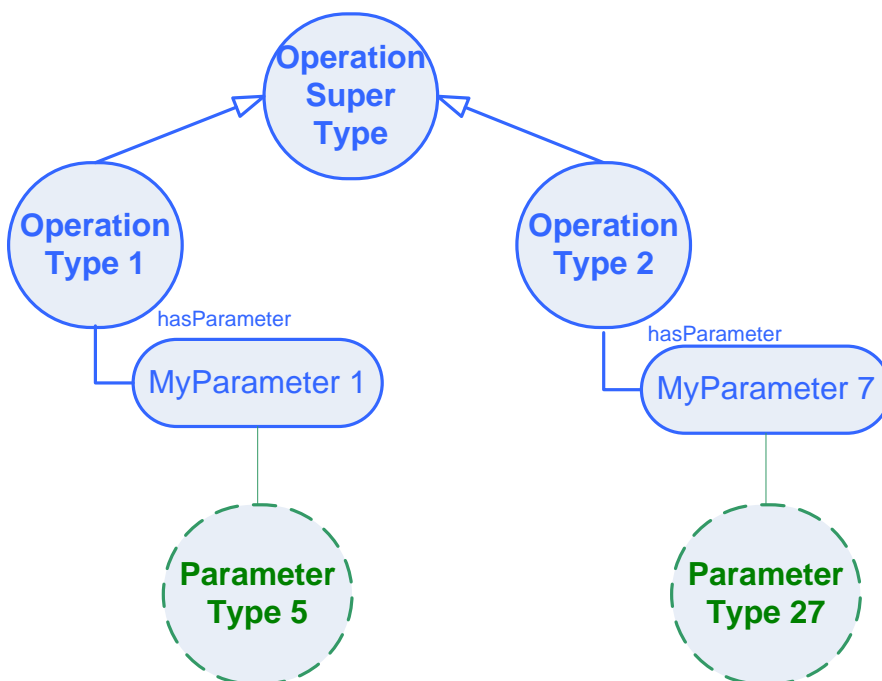

Figure 29: Example of Operation Types and their Parameters

Figure 30 sketches an example of a Thing Type hierarchy. Some of the Aspects of a given Thing Type will be dynamic like Indoor Temperature, Speed or Occupancy and thus would be associated to Devices sensing/setting these values, others would be static like Area, Volume or Number of Floors. These could nevertheless be relevant for discovery purposes. Finally, Aspects can describe the relation to other Things, e.g. the Part of Building Aspect.

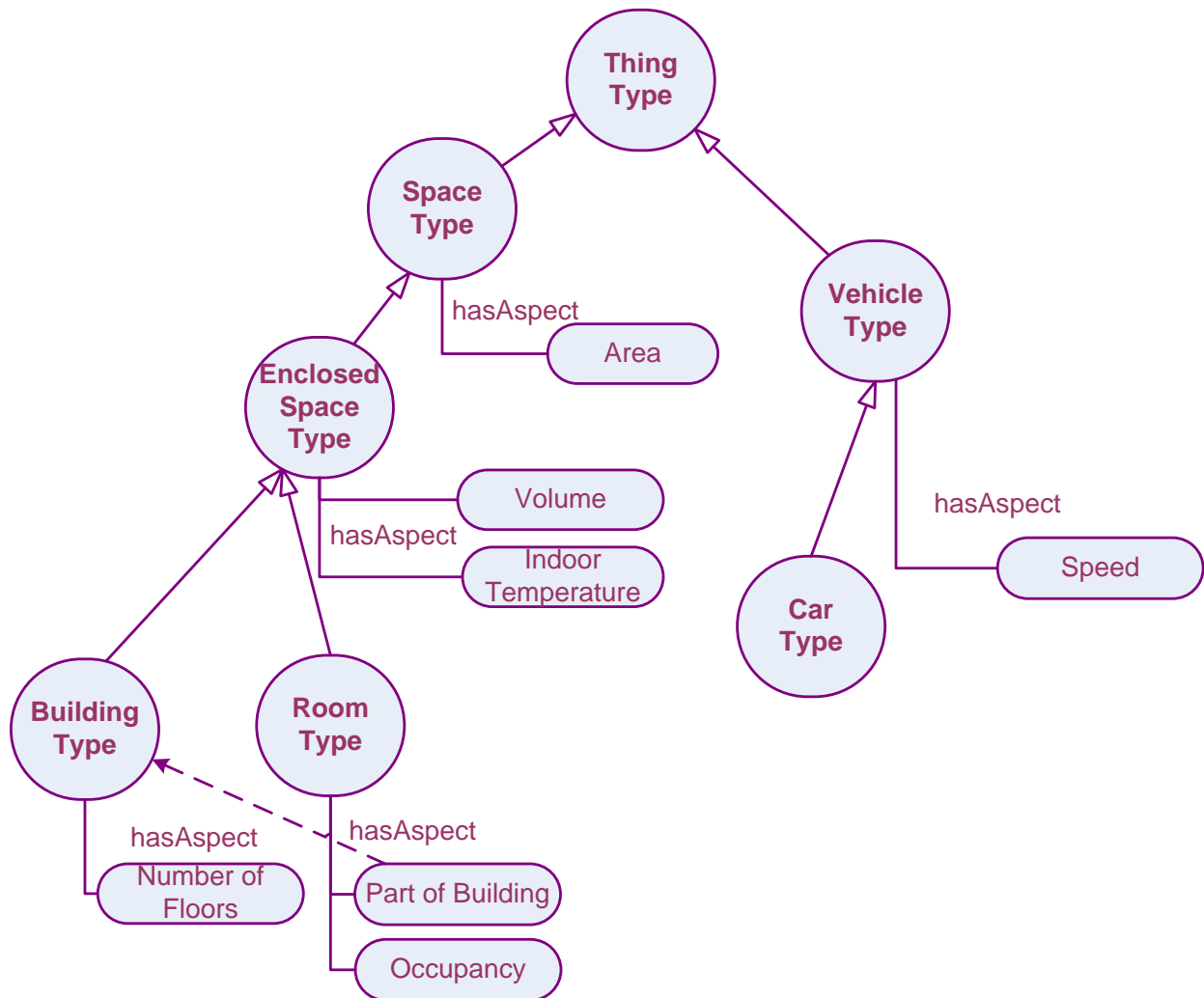

Figure 30: Example of Thing Type Hierarchy

Type hierarchies can be defined by different standardization organizations (SDOs). oneM2M can make use of these, if they follow the respective structure as defined through the concepts and their relations. In the example of Device Types, a type hierarchy of Device Types is defined where the supported Operations for each Device Type are identified. It is also possible that a common basic Device Type hierarchy is defined (e.g. by oneM2M itself) that is then extended by different SDOs. Based on these, proprietary extensions are possible, preferably by inheriting from suitable super type(s).

Given that type hierarchies are provided, the oneM2M System can make use of them, supporting multiple of them in parallel – only when it comes to supporting equivalence of types from different type hierarchies or from different extensions of type hierarchies additional work is required.

8.2.2.3 Modelling of Instances

Given the structure provided by the concepts, instances can be modelled based on the types. Figure 31 shows the structure of the Device Instance "My Device 234", which is of type Device Type 1. For that reason, it has both Operations "MyOperation 1" (inherited from Device Super Type) and "MyOperation 2", which are of Operation Type 2 and Operation Type 1 respectively.

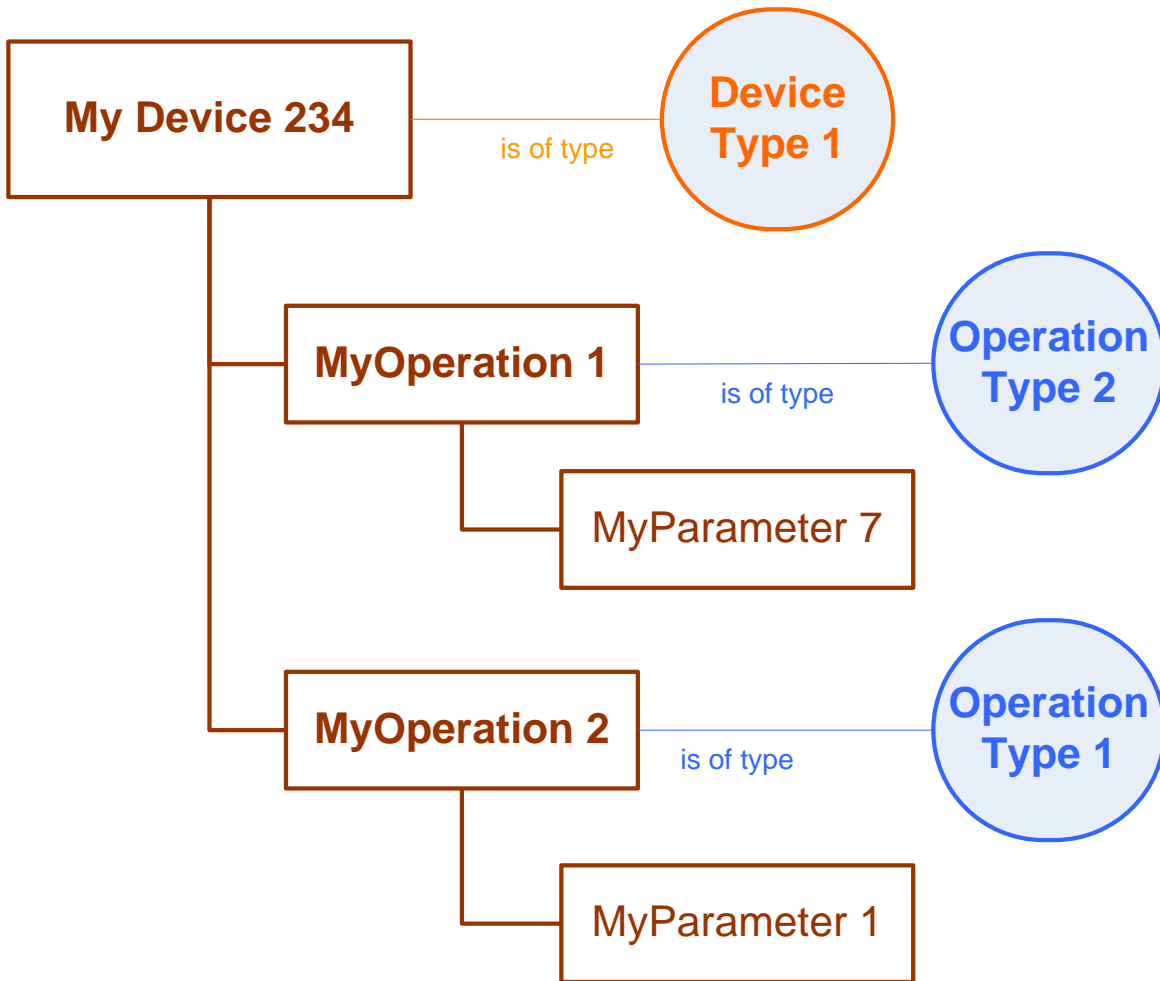

Figure 31: Example of a Device Instance based on the type modelling

The modelled Device Instance can directly be mapped to the oneM2M resource structure for the Device. The type information is also highly relevant for discovering suitable instances such as Devices and Things.

8.2.2.3 Combined view of approach

After the step-by-step introduction of concepts, types and instances as the three parts of this modelling approach, this section provides the combined view.

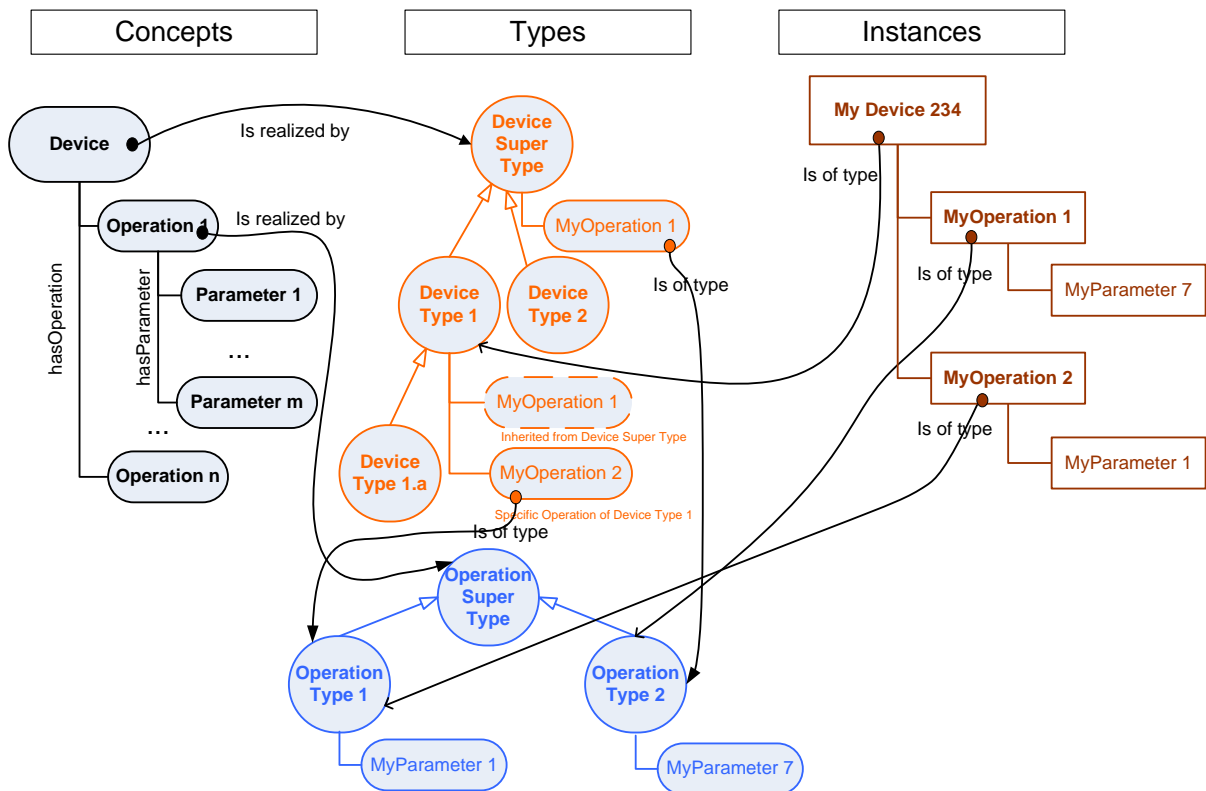

Figure 32: Overview and relation of concepts, types and instances for the example of Devices

Figure 32 shows the concepts and structure of Devices, which are – for the purpose of introducing the approach – limited to Operations and Parameters. These concepts and structure of Devices would be defined by oneM2M and provide the basis for implementing related functionalities.

Device Types introduce the specific types of Devices that are to be supported by the system together with their specific Operations. They follow the structure given by the concepts of oneM2M. Device Types can be organized in a type hierarchy. Operations again are of a certain type, which are defined in a separate type hierarchy. Operation Types introduce the specific Parameters required, which again have a type (not shown). The Device Types, Operation Types, Parameter Types etc. can be defined by other, possibly application-area specific standardization organization or be proprietary. The type information is of course relevant for the Operation of a semantically enhanced oneM2M System, but it is not statically implemented into the oneM2M system functionalities, but can rather be seen as configuration information.

Finally, the Device Instances model concrete Devices in a oneM2M deployment. They can be directly represented as Resources in the oneM2M System. Their general structure corresponds to the one defined by the concepts, e.g. that Devices have Operations. The specific Operations of a Device are defined by their respective Device Type. Linking the Device Instance to the Device Type may be relevant for oneM2M system functionalities, e.g. discovery and abstraction.

8.2.2.4 Modelling of Associations

As already shown in Section 8.2.2.2, some Aspects of Things concern dynamic values that can be measured or changed by Devices, e.g. the speed of a vehicle can be measured and the indoor temperature of a room may be changed by a heating or air conditioning system.

To capture this aspect in a system, the relation between Things and Devices can be modelled in form of Associations. The Association should describe which Aspect is associated to which Operation of a Device and what the Operation can do with respect to the Aspect, i.e. provide the information (measure, observe, etc.) or change (set, increase, decrease, etc.).

As shown in Figure 33 there are two main types of associations MeasureAssociation and SetAssociation. A MeasureAssociation represents the case in which the Device Operation measures the Thing Aspect, whereas a SetAssociation represents the case, where a device operation can be used to set the Thing Aspect, i.e. triggers an

actuation in the real world so that the state of the real world reflects the target set for the Thing Aspect. Further subtypes of associations can be defined.

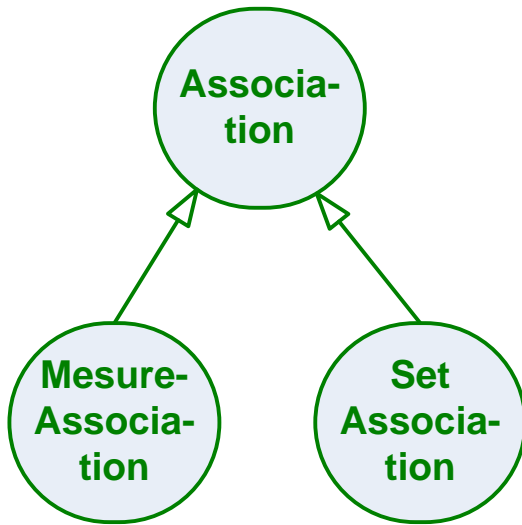

Figure 33:Types of Association

Figure 34 visualizes two examples of associations.

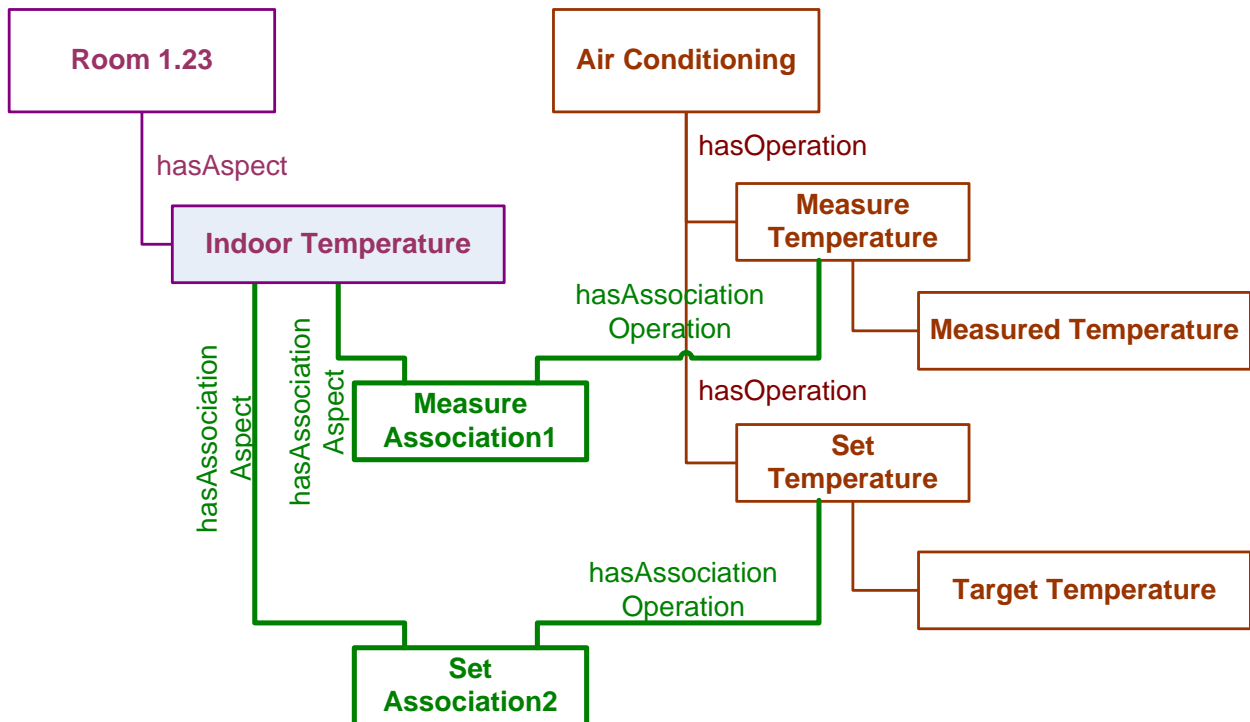

Figure 34: Association Example

Even though an association logically represents a relation between a Thing aspect and a device operation, it is modelled as a concept here. The reason is that there may be other information that is related to the association., Such information would otherwise be difficult to represent as it cannot be associated with either the Thing Aspect or the Device Operation.

Note: This approach is called reification and is typically applied in such situations.

An example for such information is quality information that is related to the Association, e.g. a measured temperature may have some accuracy that is related to the sensor and thus could be directly associated with the sensor value. However, how well this information reflects the temperature of the room and to what degree it can be trusted is a quality that is neither a property of only the room aspect nor a property of only the measured value, but a property of the relation between the two. Representing this relation as a concept allows it to have the quality aspects as properties.

8.2.3 Device and Device Template Modelling Using Ontologies

In this section we show an approach of how device types and device instances can be modelled in a homogeneous way using ontologies. The focus is on explaining the approach, not on completeness of the device types and device instance aspects being modelled. Due to their relevance for creating resource structures for representing devices in the oneM2M platform, the focus is on modelling input-output operations, but also the modeling of some manufacturer-specific aspects like manufacturer name and product identifier is shown.

The modelling follows a two-layer approach. The upper layer is for modelling device types, the lower layer for modelling device instances. The upper layer provides a given device type template that is modelled as classes and properties of an ontology. The device types are then modelled as instances of the classes and properties of this ontology. In the lower layer, the same device types that were modelled as instances of the template classes in the upper layer are now interpreted as the classes of the device ontologies. The actual individual devices can then be modelled by creating instances of these classes. The dual character of instance and class can, for example, be modelled in the OWL Full variant of the Web Ontology Language (OWL) [i.33]. In the following we show an example of how a device type can be modelled based on a device type template and an individual device based on a device type.

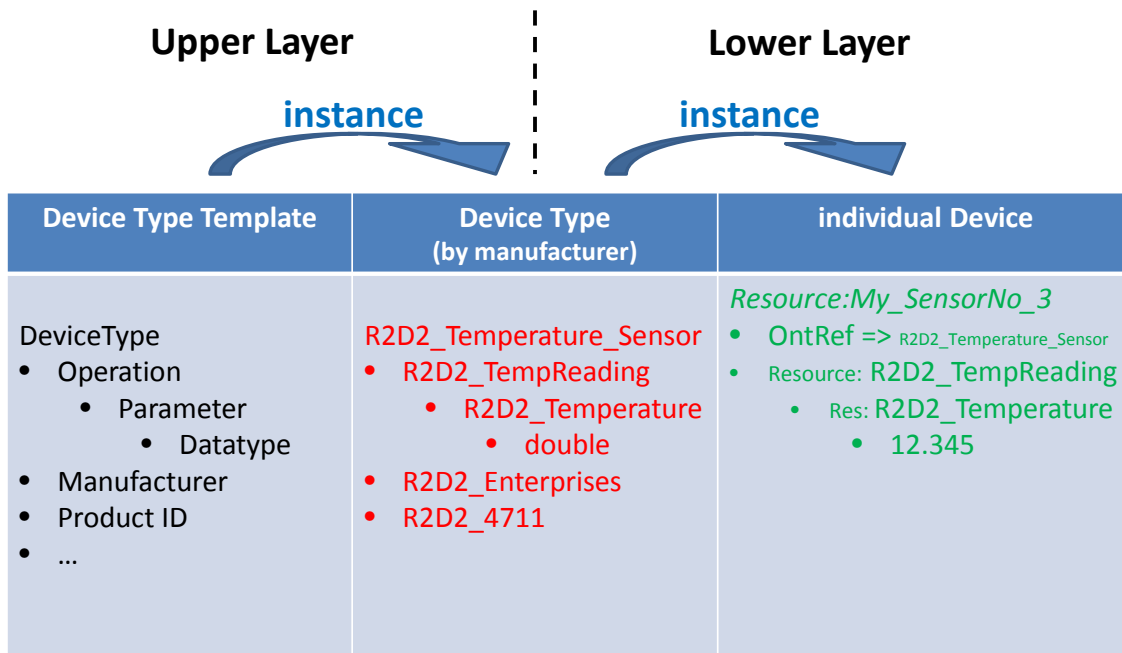

Figure 35: Modelling of device type templates, device types and individual devices

Figure 34 shows the three parts that make up the upper and lower layer, each consisting of classes and the corresponding instances. There are three and not four parts due to the dual character of the device type, which makes up an instance in the upper layer, but provides the class structure for the lower layer.

The device type template provides the structure that models a type of device, e.g. a manufacturer producing a temperature sensor can "fill out" the template by creating an ontology instance. In the case shown in Figure 34 RD2D_Enterprises manufactures an R2D2_Temperature_Sensor with the Product ID R2D2_4711. It has an operation called R2D2_TempReading, which in turn has a parameter R2D2_Temperature of type double. This information in turn serves as the structure for describing an individual temperature sensor of the type R2D2_Temperature_Sensor. It provides the basis for creating the resource structure representing the individual device in oneM2M, which is depicted on the right side of Figure 34. The value of the R2D2_Temperature parameter, which refers to the temperature measured, is given as 12.345 represented as a double.

The example has been modelled as a set of OWL Full ontologies, using imports for including required classes and properties.

In the following tables, we describe the ontology classes (Table 4) and properties (Table 5) for describing the device template in more detail. Where appropriate, subclasses can be used to model specialisations of common classes. In this case, this is done to distinguish different types of operations.

Class => SubClass	Explanation
DeviceType	Manufacturer defined name/ID for a class of alike devices (= type) that are e.g. described in a product description
Operation	Identifies an operation of the device
=> OutputOperation	The operation produces only an output message. The device does not expect correlated input/ack
=> InputOperation	The operation consists of an input message only. The device does not produce correlated input/ack
=> In-OutOperation	The operation receives an input message and produces a correlated output/ack
Parameter	Identifies a parameter of the operation
=> InputParameter	Identifies a parameter related to the input of the operation
=> OutputParameter	Identifies a parameter related to the output of the operation
DataType	Identifies the datatype of the parameter (e.g. xsd: double)

Manufacturer	Name/ID of the manufacturer
Product ID	Manufacturer defined handle/ID to identify the type of the device, e.g. Type/Model-number.

Table 5: Ontology Classes for Device Template

The class of Parameter is divided into the subclass of InputParameter and OutputParameter. InputParameter is related to the input of the operation, and OutputParameter is related to the output of the operation.

Domain	Property	Range	
DeviceType	hasOperation	Operation	Object Properties
Operation	hasParameter	Parameter	
Parameter	hasParameterType	Datatype	
<i>DeviceType</i>	<i>hasManufacturer</i>	<i>xsd:string</i>	Datatype Properties
<i>DeviceType</i>	<i>hasProductID</i>	<i>xsd:string</i>	

Table 6: Object and Datatype Properties for Device Template

In the following tables, we describe the ontology classes (Table 6) and properties (Table 7) for describing individual device instances of the R2D2_Temperature_Sensor. A hierarchy of superclasses may be defined, e.g. Temperature_Sensor and Device superclasses could be introduced, which could be useful for discovering different types of temperature sensors from different manufacturers. Also, an Abstract Temperature Sensor providing a standardized interface to applications could be introduced, either on the same level as the R2D2_Temperature_Sensor, i.e. as a subclass of TemperatureSensor, or in a separate hierarchy. In the latter case the link to the concrete temperature sensors has to be explicitly modelled.

Class => SubClass	Explanation
Device => Temperature_Sensor =>R2D2_Temperature_Sensor	User defined name/ID for a specific instance of the R2D2_Temperature_Sensor instance., e.g. My_SensorNo_3

R2D2_TempReading	Specific operation of the instance of R2D2_Temperature_Sensor
R2D2_Temperature	Specific parameter of the instance of R2D2_TempReading
Metadata	Metadata related to the value of an R2D2_Temperature

Table 7: Ontology Classes for R2D2_Temperature_Sensor

Domain	Property	Range	
R2D2_Temperature_Sensor	hasTemperatureOperation	R2D2_TempReading	Object Properties
R2D2_TempReading	hasTemperatureParameter	R2D2_Temperature	
R2D2_Temperature	hasMetadata	Metadata	
<i>R2D2_Temperature</i>	<i>hasValue</i>	<i>xsd:double</i>	Datatype Properties

Table 8: Object and Datatype Properties for R2D2_Temperature_Sensor

The listing below gives an example of how an individual device instance of the R2D2_Temperature_Sensor is modelled in OWL, using the more concise and readable Turtle representation [i.36], instead of the more commonly used RDF/XML notation [i.37].

Device Instance (in OWL/Turtle)

@prefix : <http://InstanceOntology#> .

@prefix owl: <http://www.w3.org/2002/07/owl#> .

@prefix rdf: <http://www.w3.org/1999/02/22-rdf-syntax-ns#> .

@prefix xsd: <http://www.w3.org/2001/XMLSchema#> .

@prefix dev: <http://DeviceOntology#> .

@prefix dev-temp: <http://DeviceTemplateOntology#> .

@base <http://InstanceOntology> .

<http://InstanceOntology> rdf:type owl:Ontology ;
owl:imports <http://DeviceOntology>

:Resource:My_SensorNo_3 rdf:type dev-temp:R2D2_Temperature_Sensor,

```

        owl:NamedIndividual;
        dev:hasTemperatureOperation      :R2D2_TempReading .

:R2D2_TempReading      rdf:type  dev-temp:R2D2_TempReading ,
        owl:NamedIndividual ;
        dev:hasTemperatureParameter    :R2D2_Temperature .

:R2D2_Temperature      rdf:type dev-temp:R2D2_Temperature,
        owl:NamedIndividual;
        dev:hasValue                "23.45"^^xsd:double .

```

8.3 oneM2M architectural considerations for abstraction and semantics

8.3.1 Introduction

This section analyzes whether utilisation of the analysed semantics technologies, to fulfil the oneM2M semantics related requirements, results in any architectural recommendations for, or potential constraints to, the oneM2M architectural design. This section also highlights any restrictions that the oneM2M architecture potentially places on utilisation of the analysed semantics technologies within oneM2M.

The following subsections sketch three examples of varying complexities representing semantic support in oneM2M in future releases. The idea is to show the spectrum of architectural options that oneM2M could support and thus serve as a basis for the discussion on how to proceed regarding semantic support in oneM2M. Other configurations can be envisioned for future release planning. It should be taken into account that these are only sketches highlighting core aspects and are not to be interpreted as being complete in any way.

8.3.2 Semantic Annotations

In this architectural option, the semantic support is limited to having semantic annotations within the oneM2M platform. For Release 1 of the oneM2M specification, an ontologyRef attribute for <instance> resources, <container> resources and <application> resources is foreseen. The ontologyRef is a URI that identifies the ontology that is used for representing the respective information.

Applications can read this attribute, identify the semantics of the information and use the URI to retrieve additional information, e.g. interpreting the URI as a URL and fetch additional information from there or use the URI as an identifier for looking up additional information in a semantic database. The additional information may relate to the semantic type, the structure of the data and relations to other information.

Figure 35 visualizes how semantic annotations are used. Ontology references point to an ontology that is part of some kind of semantics infrastructure. An application can read the ontology reference and then use it to access more information from the semantics infrastructure.

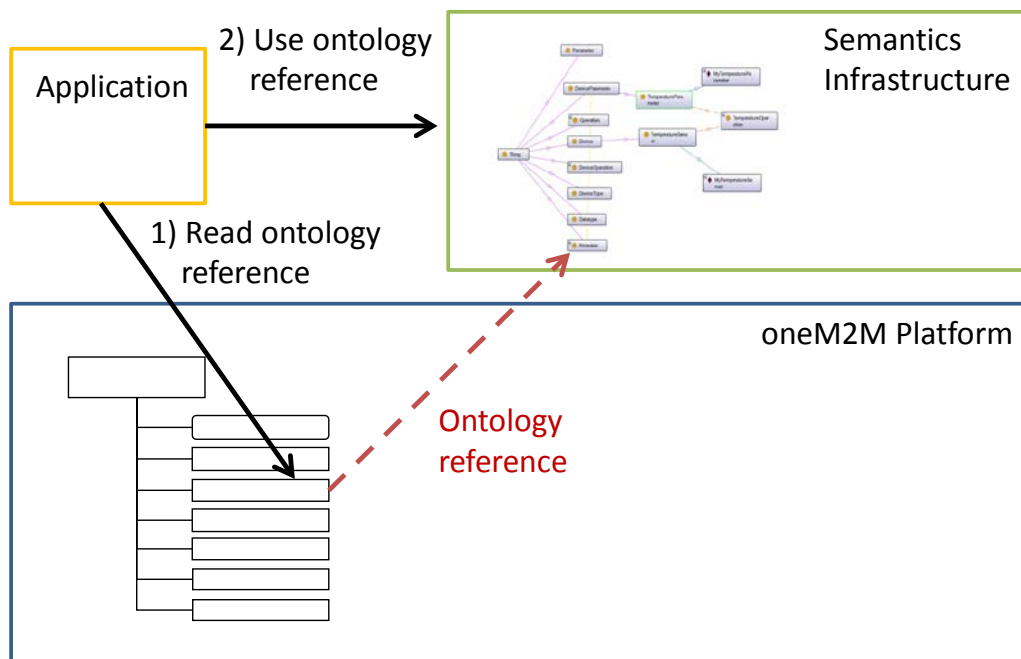

Figure 36: Semantic Annotations

This architectural option does not provide any semantic functionality within the platform itself, but, with the semantic annotations, applications can use semantic functionalities on top of the platform, e.g. for creating index structure or reasoning. Without platform support this may not be very efficient, e.g. if a large amount of information first has to be retrieved from the oneM2M platform and/or the semantic infrastructure to be able to do reasoning.

8.3.3 Use of Semantic Technologies for Platform Functionalities

In this architectural option there are some oneM2M platform functionalities that make use of semantics. This may be by using semantic functionalities and/or semantic modelling. Typically the semantic aspects are then exposed through the interface. The use of semantic aspects does not imply that the complete platform functionality uses semantics. It may be limited to some of the functions exposed through the interface.

In this architectural option, the semantic modelling is typically targeted to explicitly support the specific functionality. This often means that existing ontologies cannot be used out of the box as the oneM2M platform specifics have to be taken into account.

Two examples for semantically enhanced functionalities are the discovery functionality and the use of semantics for modelling device templates as the basis for resource creation.

To enable an expressive discovery functionality, the query could be formulated in a semantic form. This could be an existing query language like SPARQL or something oneM2M-specific. The query results would then point to oneM2M resources.

Semantic modelling can be used for defining the structure of the resources representing a specific device instance. The advantage of such a model is that concepts and relations can be explicitly modelled and this may later be reused for other aspects like the discovery functionality. The semantic model may include generic parts from existing ontologies, but core aspects have to fit the oneM2M resource structure.

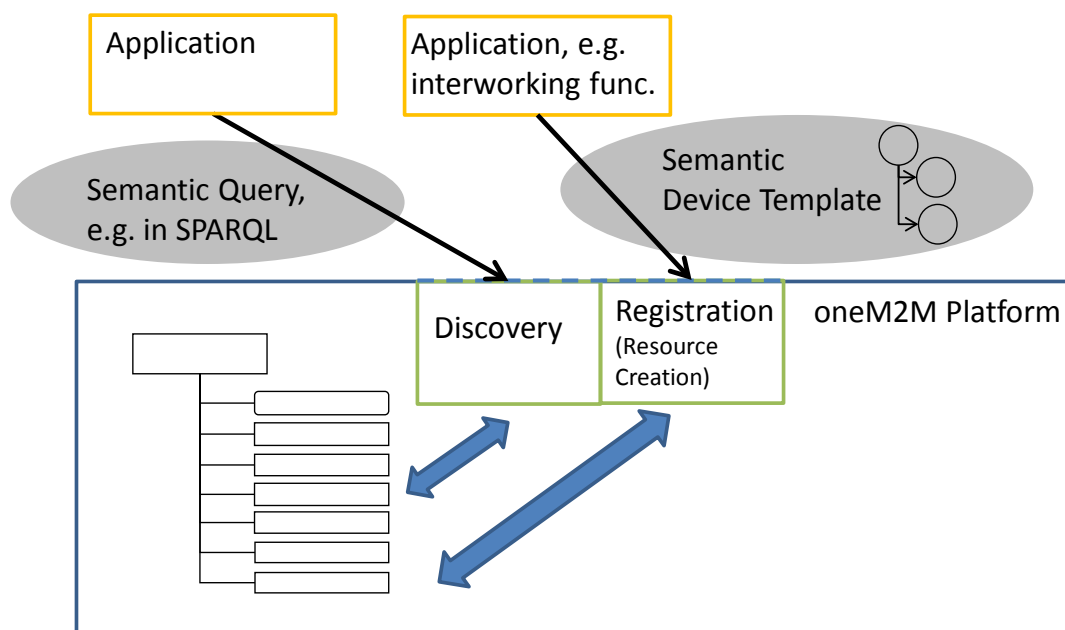

Figure 37: Use of Semantic Technologies for Platform Functionalities

Figure 36 visualizes the platform with two functionalities that have semantic elements. The applications interact with these functionalities using semantically modelled aspects in the interface. In the case of discovery this may be a semantic query – in the case of the Registration it may be a semantically modelled device template.

8.3.4 Full Semantic Platform

In the full semantic platform architectural option, the whole platform exposes all aspects in semantic form. All information is ontology-based and where possible existing ontologies are used. Instead of having specific oneM2M interfaces common semantic interface and tools are used for interacting with the platform. Such a semantic oneM2M platform could be easily integrated with existing semantic platforms like the Semantic Web.

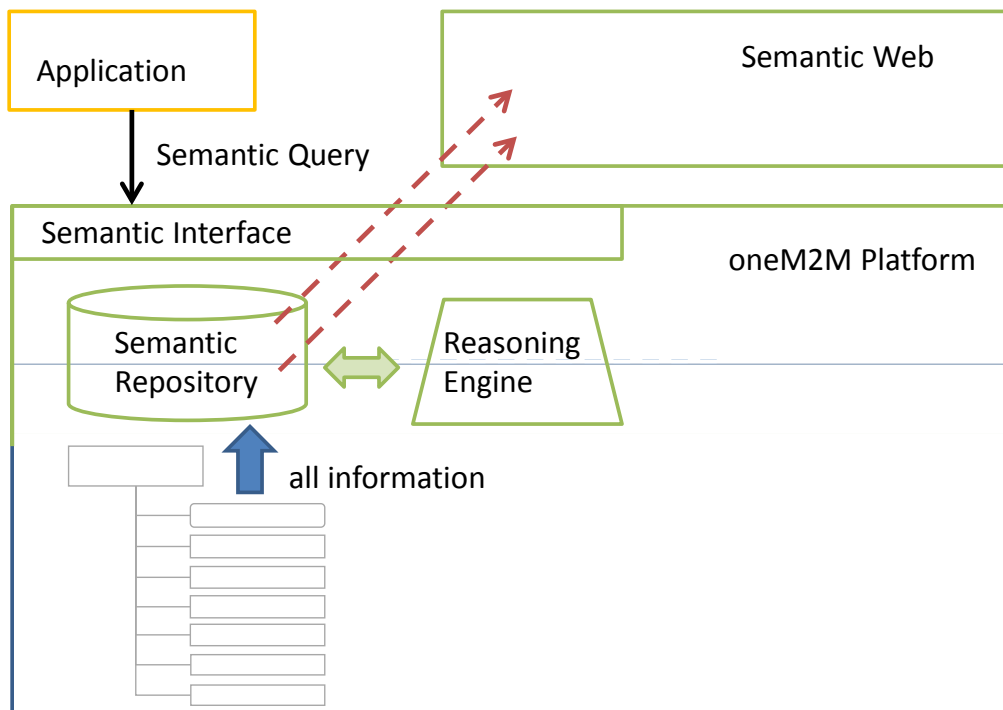

Figure 38: Full Semantic Platform

Figure 37 shows a sketch of the full semantic platform architectural option. Applications interact with the platform through a semantic interface. General semantic functionality like a reasoning engine allows the deriving of additional information. The information can easily be interlinked with the Semantic Web. Existing ontologies can be reused as much as possible.

8.4 Interworking with non oneM2M Devices and Area Networks in Rel-1

8.4.1 Semantic support in oneM2M Release 1

oneM2M Release 1 does not yet provide full semantic functions. However some limited aspects of semantics can already be used in Rel-1 to support interworking with Area networks and non-oneM2M devices. For that purpose only the structure information (concepts, relations), that is contained in ontologies, is proposed to be used in Rel-1. A mechanism (a “cook book”) is described that shows how that structure information can be utilized to create oneM2M resources (AEs and Containers) that are needed for interworking with non-oneM2M devices and area networks. For that purpose the “ontologyRef” attribute of AEs and Containers as described in oneM2M TS 0001 [i.38] is used.

It should be noted that this approach for Rel-1 does not yet allow for more dynamic usage of semantic information like discovery, reasoning or mesh-ups.

8.4.2 Basic functional principles

Annex F of TS 0001 describes Interworking / Integration of non-oneM2M solutions and protocols with the oneM2M System. Interworking is accomplished through specialized M2M Applications, called “Interworking Proxy Application Entities” (IPEs).

An Interworking Proxy Application Entity interfaces

1. a CSE of the oneM2M System (IN-CSE, MN-CSE or ASN-CSE)
2. one or more Area Networks and the Non-oneM2M devices in these Area Networks.

The Interworking Proxy maps the native data model and communication primitives of the Non-oneM2M devices into oneM2M resources that can be accessed by oneM2M procedures (Create, Retrieve, Update, Delete). Interworked non-oneM2M devices communicate over Area Networks with the Nodes (IN, MN or ASN) of oneM2M and these Nodes therefore need to contain communication capabilities to for the Area Networks. Note, that Area Networks for legacy technologies (e.g. Mbus/COSEM) often are not based on IP.

The following figure illustrates how a M2M Application (e.g. a Utility Application) can access non-oneM2M devices (e.g. Sensors/Meters implementing Mbus/COSEM or ZigBee technology) that interwork via Interworking Proxies with the oneM2M System.

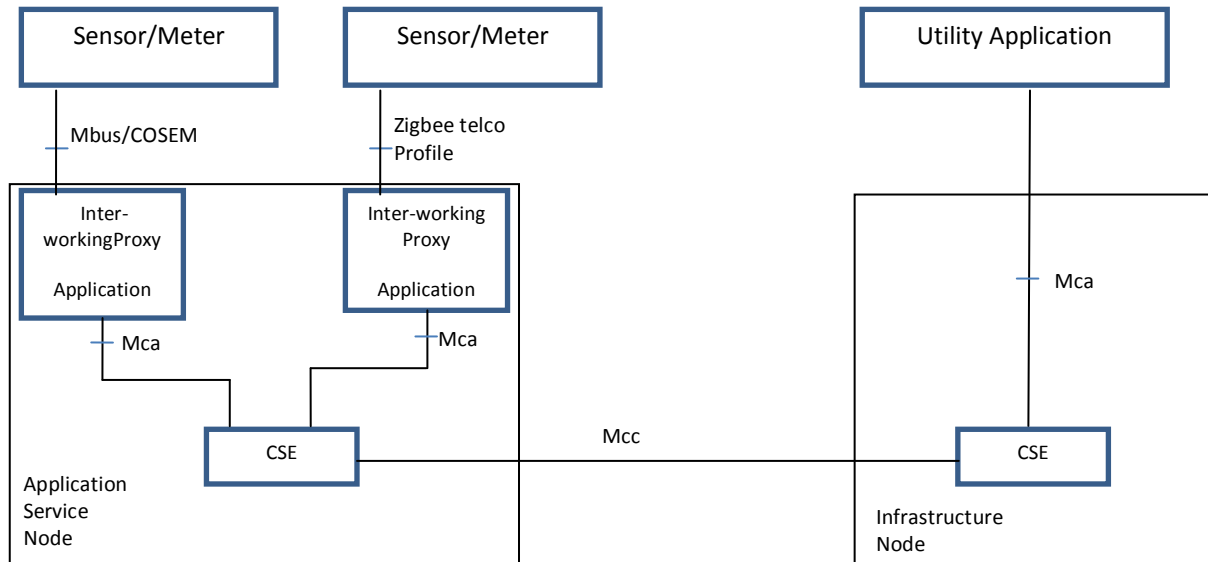

Figure 39:

In this example, the scenario has been modelled with two IPEs within a node. In a different scenario there could also just be a single IPE responsible for both networks.

8.4.3 Generic topology for interworking with non-oneM2M devices and Area Networks

The following figure Y shows the concept model (following the Approach described in Section 8.2.1) representing an Area Network, its non-oneM2M devices as well as its relationship to an Interworking Proxy Application Entity (IPE). In Section 8.2 the modelling approach was presented, using a simpler model consisting of devices, operations and parameters. In this section we propose a solution that also takes into account M2M networks and has a more fine-grained modelling differentiating between non-oneM2M devices and FunctionBlocks. As Section 8.4 deals with interworking with other technologies, we explicitly model *non-oneM2M devices*. oneM2M devices are already modelled using the oneM2M resource structure and therefore are not considered here.

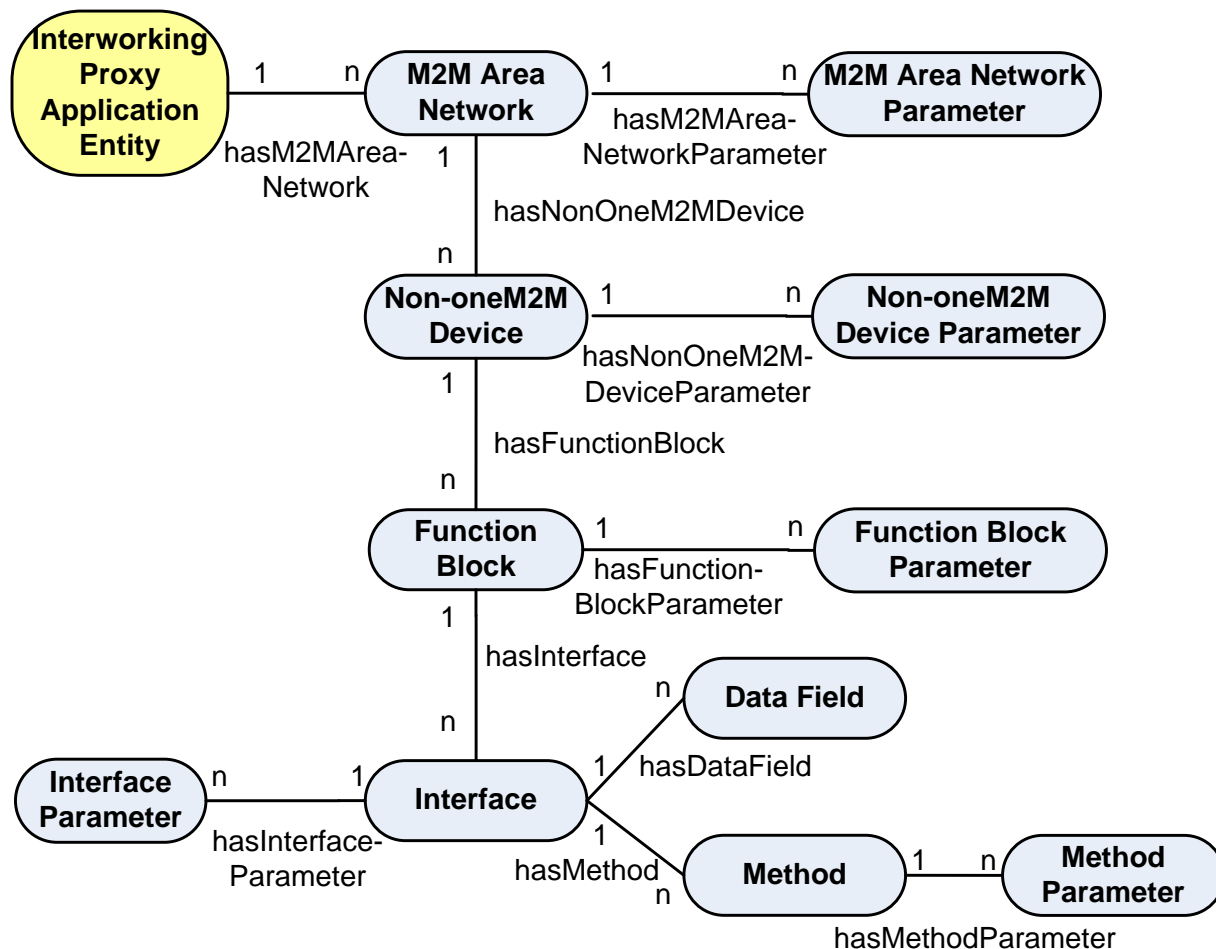

Figure 40:

An **Interworking Proxy Application Entity** is an M2M Application that communicates with one or more M2M Area Networks.

The **M2M Area Network** contains a number of non-oneM2M Devices (example: ZigBee network with Home Automation Profile)

Each **non-oneM2M Device** is an entity of the M2M Area Network that contains one or more Function Blocks (example: ZigBee device object)

A **Function Block** is a sub-unit of a non-oneM2M Device that performs a some services of the non-oneM2M Device (example: ZigBee Thermostat, a ZigBee Temperature Sensor)

Each Function Block has **Interfaces** for communication of data to/from the Function Block. Each Interface consists of combinations of

- **Data Fields** that can be read and/or updated
- **Methods** that can be executed

Each Method has its **Method Parameters** that can (a) be input to the device or (b) output from the device.

8.4.4 Semantic modelling of interworking

In Section 8.4.3 the high-level semantic concepts and their relations have been defined. These high-level concepts are used for defining the oneM2M resource structure for interworking. According to the type modelling described in Section 8.2.2.2 the specific type related to the respective high-level concepts can be modelled and the ontologyRef attribute can be used to refer to it. For example, a ZigBeeTemperatureSensor can be modelled as a specific device, so

the ontologyRef could be [http://\[ZigBeeOntology\]#TemperatureSensor](http://[ZigBeeOntology]#TemperatureSensor), indicating that the modelled device AE actually represents a temperature sensor.

For modelling the high-level semantic concepts *AE* resources and *container* resources are used. *AE* resources are used for those concepts where functionality may be handled by independent applications. Other concepts, as well as relations between concepts, are modelled by containers and subcontainers respectively, using the respective *ontologyRef* attribute to reference the ontology concept (e.g. OWL class) or the relation (e.g. OWL object properties). The values in the final subcontainer instance contain the URL of the oneM2M resource providing the content of the referenced instance. For example, the M2M Area Network may be modelled as an *AE* Resource. The relation *hasNon-oneM2M Device* between the concepts *M2M Area Network* and *Non-oneM2M Device* to describe that an M2M Area Network contains non-oneM2M Devices is mapped to a container for “hasNon-oneM2M Device”, which has a subcontainer for each Non-oneM2MDevice, which is part of the network. The instance of the subcontainer resource contains the resource URI pointing to the *AE* Resource of the Non-oneM2MDevice.

In this way, any oneM2M application can utilize the fixed resource structure to access data and semantic-aware oneM2M applications can use the *ontologyRef* attribute to find out about the more specific semantic content of the resources, e.g. that the Non-oneM2M device is actually a ZigBee temperature sensor.

8.4.5 Mapping into oneM2M resources

This clause describes the mapping principles that are used to map a generic M2M Area Network into a structured tree of oneM2M resources.

Naming convention: Following the convention in section 9.5 of [i.38]

- A string delimited with '<' and '>' e.g. <resourceType> is a placeholder for the type of a resource.
- A string delimited with '[' and ']' e.g. [resourceName] is a placeholder for the name of a resource or an attribute.

Similarly, italics are used for use of ontologies (e.g. *oneM2M_ontology*) For example, the expression: [http://\[oneM2M_ontology\]#Area_Network](http://[oneM2M_ontology]#Area_Network) would indicate a concept *Area_Network* in some ontology. *[oneM2M_ontology]* is the placeholder for the name of that ontology, [http://\[oneM2M_ontology\]](http://[oneM2M_ontology]) is the URI of that ontology.

As explained before, the IPE is an M2M Application.

The basic principle followed here is to map Non-oneM2M entities (M2M Area Networks, non-oneM2M Devices) that are accessible via the IPEA application are mapped into resources of type <AE> that are linked to the IPEA resource. The entities Function Blocks, Interfaces, Data Fields, Methods and Method Parameters are mapped into *container* resources as sub resources of a non-oneM2M Device AE. Figure 1 shows this high-level mapping.

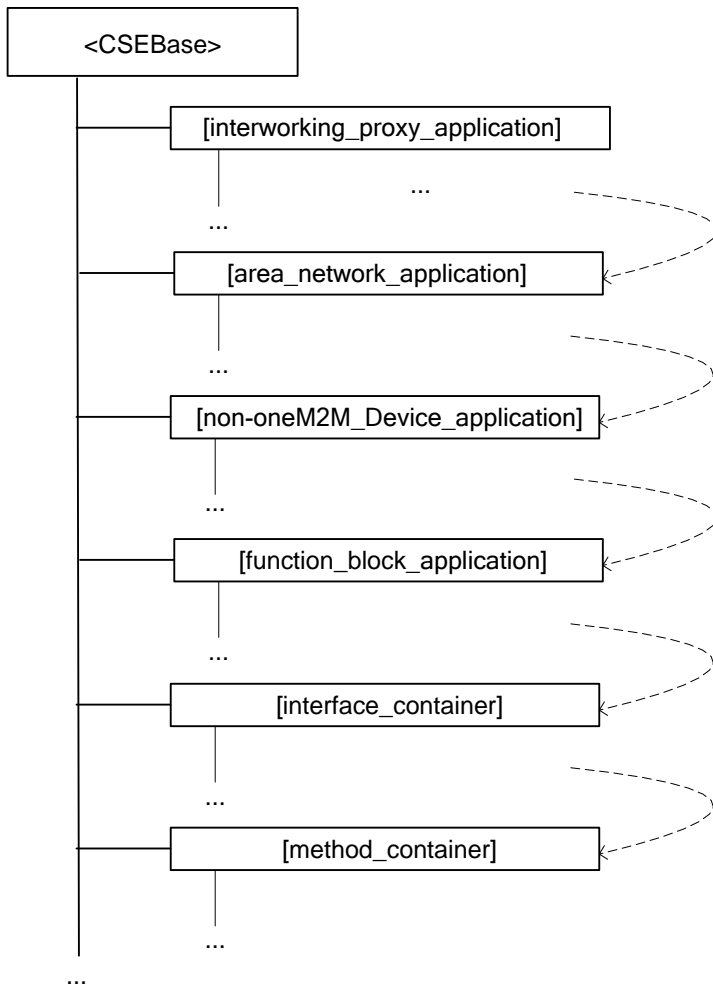

Figure 41: **High-level resource structure for interworking**

8.4.5.1 Interworking Proxy Application Entity

The Interworking Proxy Application Entity (IPE) is modelled as a resource [interworking_proxy_application] of Resource Type <AE>. The URI used to access this resource has the following format:

[CSEBase]/[interworking_proxy_application]
 e.g.: IN-CSEID.m2m.myoperator.org/CSERoot/myIPE

Note: While the addressing in the example above and in the rest of this section follows the Hierarchical URI Method convention ([i.38], section 9.3.1) all three different methods for addressing a resource within the oneM2M resource structure as described in [i.38], section 9.3.1 are possible.

[CSEBase] is the Hosting CSE (IN-CSE, MN-CSE or ASN-CSE) where the IPE had been created by administrative means.

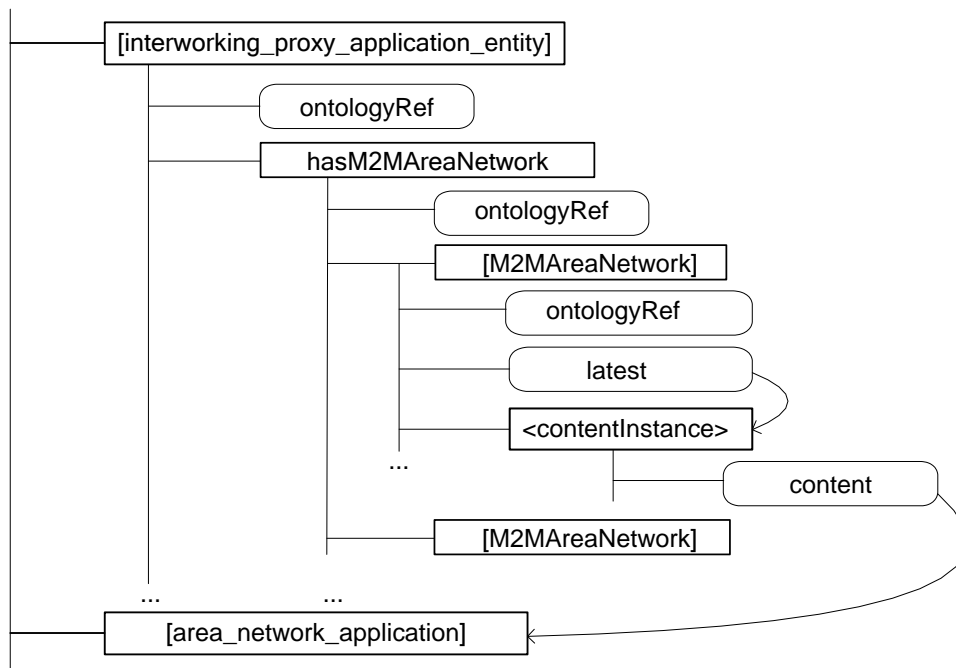

Figure 42:

The ontologyRef attribute of the [interworking_proxy_application] resource has a value of:

http://[oneM2M_ontology] #IPEA

or a more specific variant (e.g. a specific IPE for home automation by some industry group) that is a sub-class of the IPE class in the oneM2M_ontology.

8.4.5.1.1 Linking the Interworking Proxy Application Entity to its M2M Area Networks

The Interworking Proxy Application Entity resource contains a sub resource of type <container> with the fixed name *hasM2MAreaNetwork* that mirrors the relation *hasM2MAreaNetwork* between the concepts *InterworkingProxyApplication* and *M2M Area Network*. It contains subcontainers with references to each M2M Area Network the IPE supports.

The URI used to access this <container> resource has the following format:

[CSEBase]/[interworking_proxy_application]/hasM2MAreaNetwork

e.g.: IN-CSEID.m2m.myoperator.org/CSERoot/myIPE/hasM2MAreaNetwork

The hasM2MAreaNetwork resource of type <container> contains sub-containers of type <container>. Each sub-container of the hasM2MAreaNetwork container holds a reference to an M2M Application that represents one M2M Area network that is supported by the IPE.

When a new M2M Area network is supported by the IPE then the IPE:

1. creates a new M2M Area Network Application
2. creates a new sub-container in the hasM2MAreaNetwork container whose contentInstance contains a reference to the M2M Area Network Application

8.4.5.2 M2M Area Network Application:

The M2M Area Network Application is modelled as a resource [area_network_application] of Resource Type <AE>. An M2M Area Network Application is created by an IPE.

The URI used to access this resource has the following format:

[CSEBase]/[area_network_application]

e.g.: IN-CSEID.m2m.myoperator.org/CSERoot/myIPE_ZigBeeNW

The M2M Area Network Application is responsible for:

- managing the one M2M Area Network, containing technology dependent logic.
The management of the one M2M Area Network may be supported by using oneM2M Management Functions (e.g. by utilizing a related *areaNwkInfo* resource)
- discovering the M2M Area Network structure (devices, etc.) and keeping track of changes of the structure;

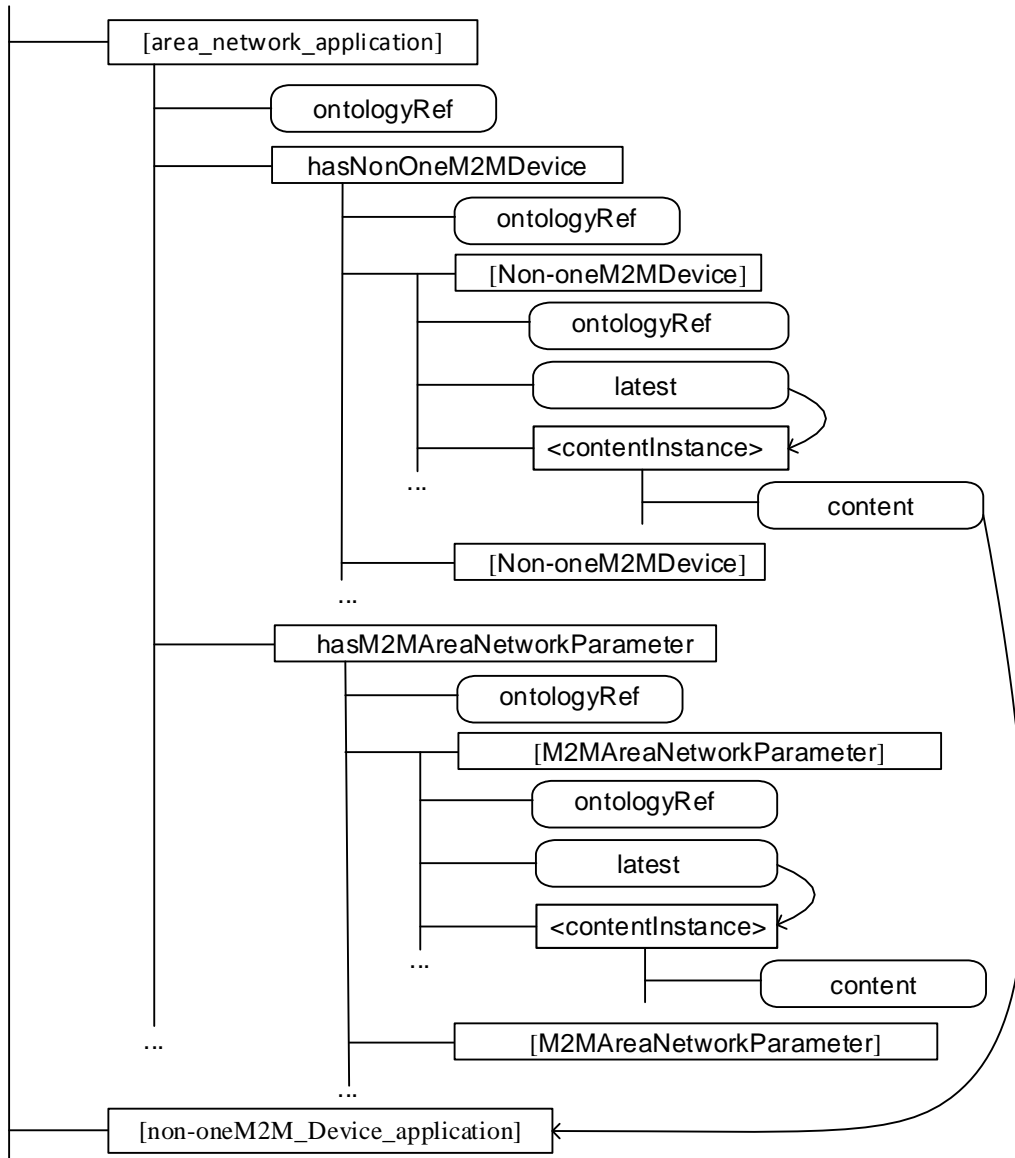

Figure 43:

The M2M Area Network Application is dependent on the technology of the M2M Area Network and the hardware (drivers, etc.) of the area network communication module.

The ontologyRef attribute of the [area_network_application] resource has a value of:

http://[oneM2M_ontology] #Area_Network

or a technology specific variant that is a sub-class of the oneM2M_ontology, e.g.:

http:// [ZigBee_ontology] #ZigBee_Area_Network

8.4.5.2.1 Linking the M2M Area Network to its non-oneM2M devices

The M2M Area Network Application resource contains a sub resource of type container with the fixed name *hasNonOneM2MDevice* that mirrors the relation *hasNon-oneM2M Device* between the concepts *M2M Area Network* and *Non-oneM2M Device*.

The URI used to access this <container> resource has the following format:

[CSEBase]/[area_network_application]/hasNonOneM2MDevice
e.g.: IN-CSEID.m2m.myoperator.org/CSERoot/myIPE/ hasNonOneM2MDevice

The ontologyRef attribute of the hasNonOneM2MDevice container has a value of:

http://[oneM2M_ontology] #hasNonOneM2MDevice

or a more specific variant that is a sub-property of the *hasNonOneM2MDevice* property in the oneM2M_ontology.

This hasNonOneM2MDevice container in turn has sub-containers [Non-oneM2M_Device] whose contentInstance each holds a reference to an M2M Application that represents one non-oneM2M Device in the M2M Area Network.

The URI used to access a [Non-oneM2M_Device] <container> resource whose contentInstance contains the reference to a Non-oneM2M Device Application has the following format:

[CSEBase]/[area_network_application]/hasNonOneM2MDevice/[Non-oneM2M_Device]
e.g.: IN-CSEID.m2m.myoperator.org/CSERoot/myIPE/ hasNonOneM2MDevice/myNon-oneM2M_Device_1

8.4.5.2.2 Parameters of the M2M Area Network

The M2M Area Network Application resource contains a sub resource of type <container> with the fixed name *hasM2MAreaNetworkParameter* that contains the parameters for that M2M Area Network.

The URI used to access this <container> resource has the following format:

[CSEBase]/[area_network_application]/hasM2MAreaNetworkParameter
e.g.: IN-CSEID.m2m.myoperator.org/CSERoot/myIPE/ hasM2MAreaNetworkParameter

The ontologyRef attribute of the hasM2MAreaNetworkParameter container has a value of:

http://[oneM2M_ontology] #hasM2MAreaNetworkParameter

or a more specific variant that is a sub-property of the *hasM2MAreaNetworkParameter* property in the oneM2M_ontology.

This *hasNonOneM2MDevice* container in turn has sub-containers [M2MAreaNetworkParameter] that each contain the value of that parameter. The ontologyRef attribute of the [M2MAreaNetworkParameter] container has a value of:

http://[oneM2M_ontology] #M2MAreaNetworkParameter

or a technology specific variant that is a sub-class of *M2MAreaNetworkParameter* of the oneM2M_ontology, e.g.:

http://[ZigBee_ontology] #ZigBee_Area_Network_Parameter.

The contentInstance of the [M2MAreaNetworkParameter] container will contain the value of that parameter as (opaque) content.

If the ontology containing the *M2MAreaNetworkParameter* (or its sub-class in the technology specific ontology) additionally specifies the data type of the parameter (e.g. as *DatatypeProperty* in OWL) then the ontologyRef attribute of the contentInstance may contain the value of that datatype. E.g.:

http://www.w3.org/2001/XMLSchema#positiveInteger

8.4.5.2.3 Functional description of the M2M Area Network Application:

When a new non-oneM2M Device is added to/removed from the M2M Area Network then the M2M Area Network Application:

1. creates/deletes the Non-oneM2M Device Application
2. creates/deletes the sub-container of its hasNonOneM2MDevice container whose contentInstance contains the reference to the Non-oneM2M Device Application

8.4.5.3 Non-oneM2M Device Application:

The Non-oneM2M Device Application is modelled as a resource [non-oneM2M_Device_application] of Resource Type <AE>. A Non-oneM2M Device Application is created by an M2M Area Network Application.

The URI used to access this resource has the following format:

[CSEBase]/[non-oneM2M_Device_application]

e.g.: IN-CSEID.m2m.myoperator.org/CSERoot/myIPE_ZigBeeNW_HomeController

The Non-oneM2M Device Application is responsible for:

- communicating with the Non-oneM2M Device by using (technology specific) communication means of the M2M Area Network
- exposing function blocks of the Non-oneM2M Device

The ontologyRef attribute of the [non-oneM2M_Device_application] resource has a value of:

http://[oneM2M_ontology] #non_oneM2M_Device

or a technology specific variant that is a sub-class of the oneM2M_ontology, e.g.:

http://[ZigBee_ontology] #ZigBee_Router_node

8.4.5.3.1 Linking the non-oneM2M device to its Function blocks

The Non-oneM2M Device Application resource contains a sub resource of type <container> with the fixed name hasFunctionBlock that mirrors the relation *hasFunctionBlock* between the concepts *Non-oneM2M Device* and *FunctionBlock*.

The URI used to access this <container> resource has the following format:

[CSEBase]/ [non-oneM2M_Device_application]/hasFunctionBlock

e.g.: IN-CSEID.m2m.myoperator.org/CSERoot/
myIPE_ZigBeeNW_HomeController/hasFunctionBlock

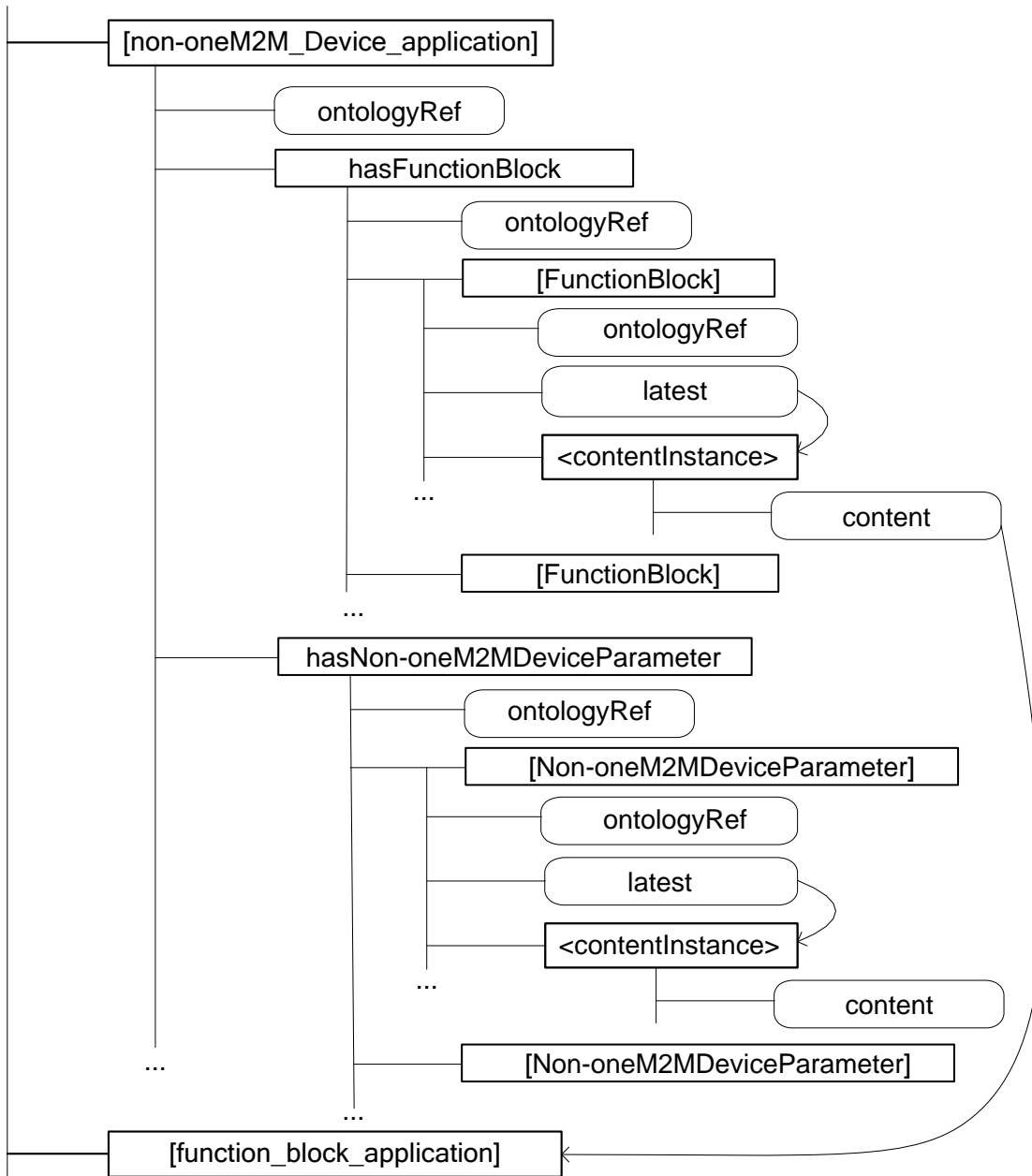

Figure 44:

The ontologyRef attribute of the hasFunctionBlock container has a value of:

http://[oneM2M_ontology] #hasFunctionBlock

or a more specific variant that is a sub-property of the *hasFunctionBlock* property in the oneM2M ontology.

This hasFunctionBlock container in turn has sub-containers [FunctionBlock] that each hold a reference to an M2M Application that represents one Function Block of the non-oneM2M Device.

8.4.5.3.2 Parameters of the Non-oneM2M Device Application

The Non-oneM2M Device Application resource contains a sub resource of type <container> with the fixed name hasNon-oneM2M DeviceParameter that contains the parameters for that M2M Area Network.

The ontologyRef attribute of the hasNon-oneM2MDeviceParameter container has a value of:

http://[oneM2M_ontology]#hasNon-oneM2MDeviceParameter

or a more specific variant that is a sub-property of the *hasNon-oneM2MDeviceParameter* property in the oneM2M ontology.

This hasNon-oneM2M DeviceParameter container in turn has sub-containers [Non-oneM2MDeviceParameter] that each contain the value of that parameter. The ontologyRef attributes of the [Non-oneM2MDeviceParameter] container and its contentInstances are built analogously to 8.4.5.2.2.

8.4.5.3.3 Functional description of the Non-oneM2M Device Application:

When a new non-oneM2M Device has been created by the M2M Area Network Application then, by administrative means (manually or automatically if the technology of the non-oneM2M network enables transmission of the relevant information) the Non-oneM2M Device Application:

1. creates new Function Block Applications for the non-oneM2M Device
2. creates new contentInstances in its hasFunctionBlock container that contains references to the Function Block Applications

8.4.5.4 Function Block Application:

Function Blocks of a non-oneM2M device are sub-functions of the device. Communication with one function block is independent from communication with other function blocks.

An example of a function block could be a ZigBee® application on a ZigBee® node (a non-oneM2M Device).

The Function Block Application is modelled as a resource [function_block_application] of Resource Type <AE>. A Function Block Application is created by a Non-oneM2M Device Application.

The URI used to access this resource has the following format:

[CSEBase]/ [function_block_application]

The Function Block Application is responsible for:

- communicating with the function block on the Non-oneM2M Device by using (technology specific) communication means of the M2M Area Network
- exposing function blocks of the Non-oneM2M Device

The ontologyRef attribute of the [function_block_application] resource has a value of:

http://[oneM2M_ontology] #function_Block

or a technology specific variant that is a sub-class of the oneM2M_ontology, e.g.:

http://[ZigBee_ontology] #ZigBee_Router_application

8.4.5.4.1 Linking the Function block to its Interfaces

The Function Block Application resource contains sub resources of type <container> with the fixed name hasInterface that mirrors the relation *hasInterface* between the concepts *FunctionBlock* and *Interface*.

The ontologyRef attribute of the *hasInterface* container has a value of:

http://[oneM2M_ontology] #hasInterface

or a more specific variant that is a sub-property of the *hasInterface* property in the oneM2M ontology.

This hasInterface container in turn has sub-containers [Interface] whose contentInstance each holds a reference to a resource of type <container>, representing one Interface of the Function Block.

The URI used to access this *container* resource has the following format:

[CSEBase]/ [function_block_application]/hasInterface

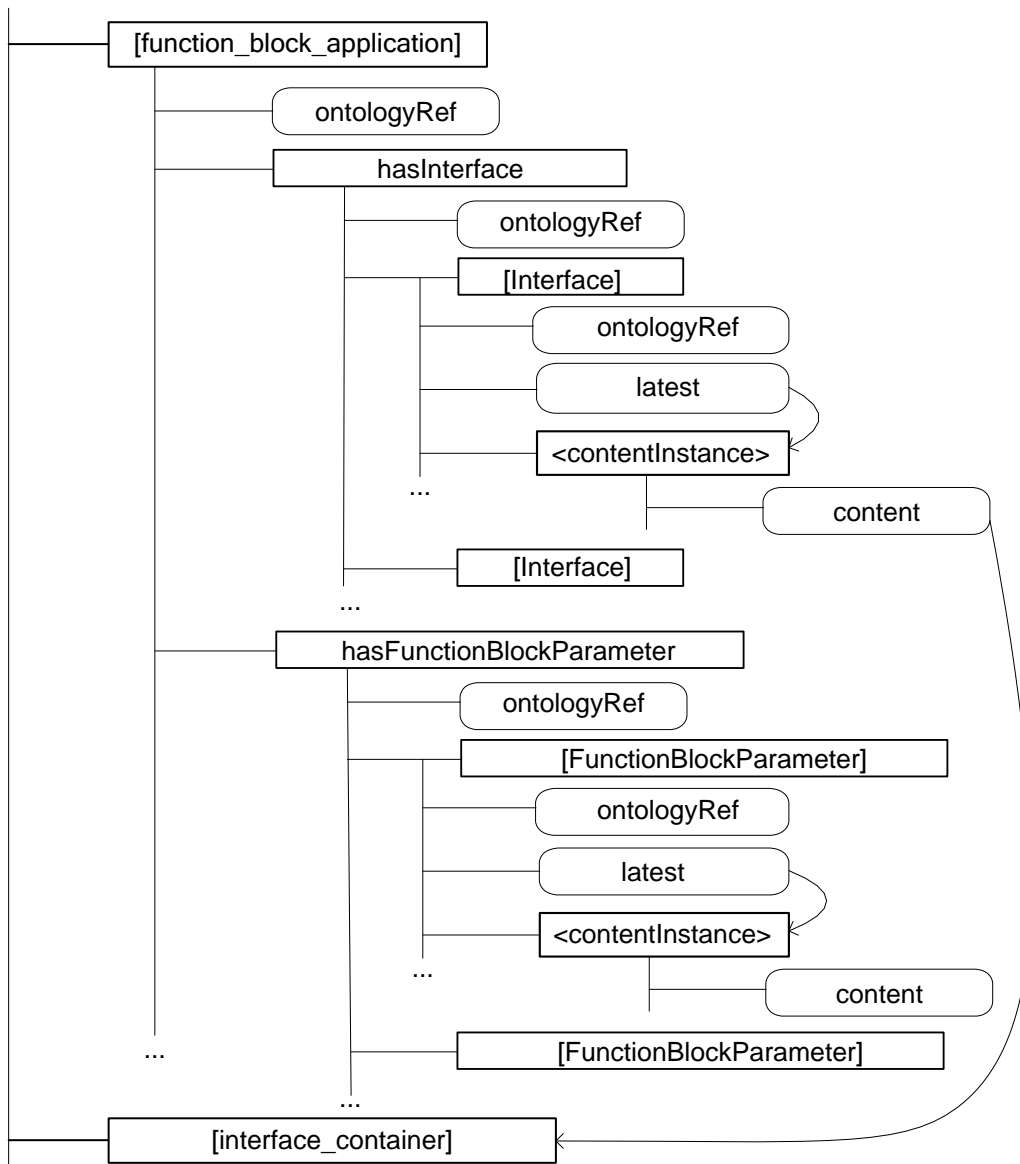

Figure 45:

8.4.5.4.2 Parameters of the Function Block Application

The Function Block Application resource contains a sub resource of type <container> with the fixed name hasFunctionBlockParameter that contains the parameters for that Function Block.

The *ontologyRef* attribute of the hasFunctionBlockParameter container has a value of:

http://[oneM2M_ontology]#hasFunctionBlockParameter

or a more specific variant that is a sub-property of the hasFunctionBlockParameter property in the oneM2M ontology.

This hasFunctionBlockParameter container in turn has sub-containers [FunctionBlockParameter] that each contain the value of that parameter. The *ontologyRef* attributes of the [FunctionBlockParameter] container and its *contentInstances* are built analogously to 8.4.5.2.2.

8.4.5.4.3 Functional description of the Function Block Application:

When a new Function Block Application has been created by the non-oneM2M Device Application then the Function Block Application:

1. creates new Interface containers for the Function Block
2. creates new contentInstances in its hasInterface container that contains references to the Interfaces

8.4.5.5 Interface container:

The Interface Container is modelled as a resource [interface_container] of Resource Type *container*. An M2M Area Network Application is created by an IPE.

The URI used to access this resource has the following format:

[CSEBase]/[interface_container]

e.g.: IN-CSEID.m2m.myoperator.org/CSERoot/mySensorInterface

The Interface Container is the oneM2M representation of the interfaces (data fields and methods of function blocks of non-oneM2M devices,

- providing access to the data fields and/or methods of the interface
- providing access to any parameters that are directly related to the interface

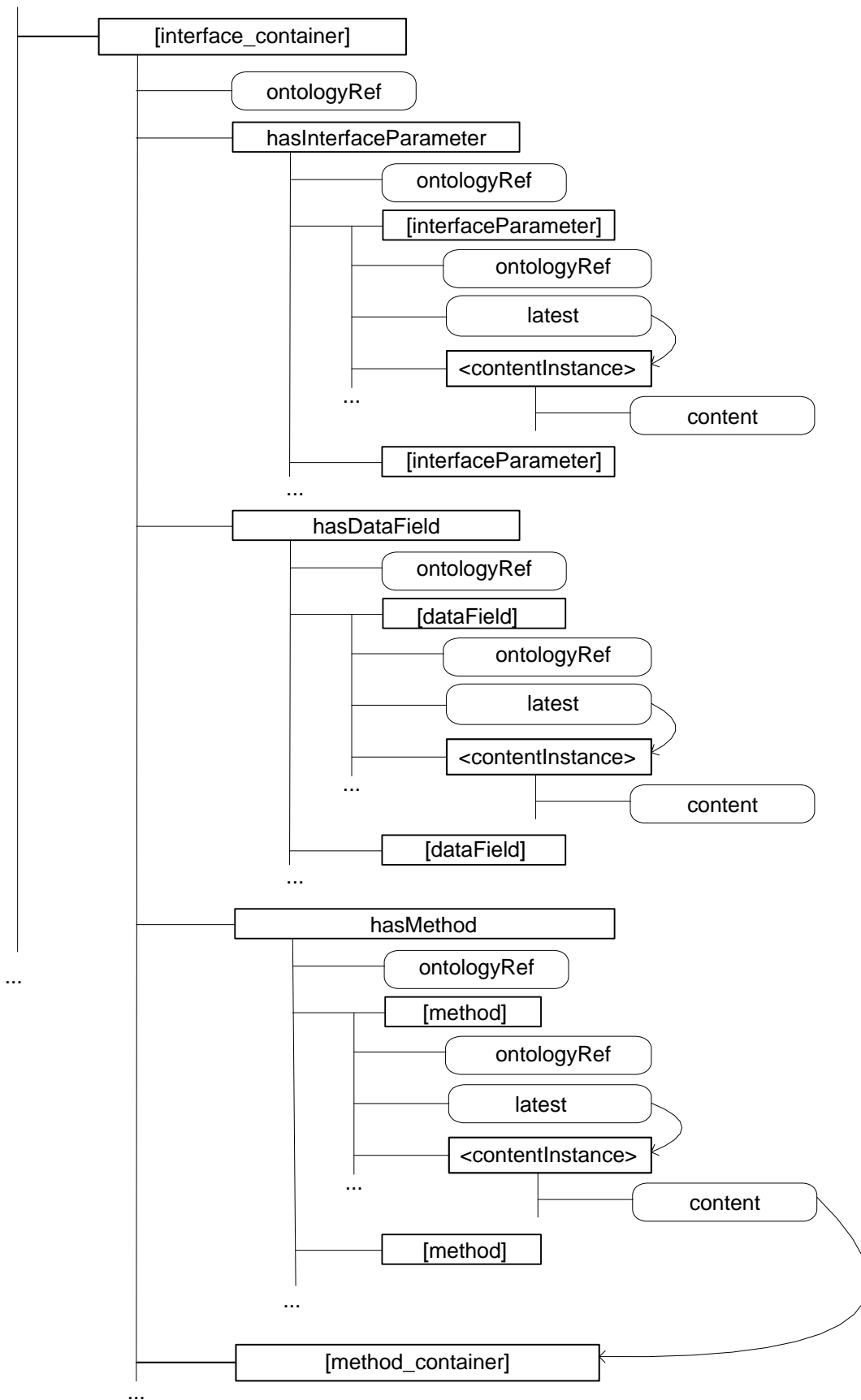

Figure 46:

The ontologyRef attribute of the [interface_container] resource has a value of:

http://[oneM2M_ontology] #Interface

or a technology specific variant that is a sub-class of the oneM2M_ontology, e.g.:

http:// [ZigBee_ontology] #ZigBee_Interface

8.4.5.5.1 Linking the Interface to its Data Fields

The Interface Container resource contains a sub resource of type <container> with the fixed name hasDataField that mirrors the relation *hasDataField* between the concepts *Interface* and *Data Field*.

The URI used to access this <container> resource has the following format:

[CSEBase]/[interface_container]/hasDataField

e.g.: IN-CSEID.m2m.myoperator.org/CSERoot/mySensorInterface/ hasDataField

The ontologyRef attribute of the hasDataField container has a value of:

http://[oneM2M_ontology] #hasDataField

or a more specific variant that is a sub-class of the *hasDataField* class in the oneM2M_ontology.

This *hasDataField* container in turn has sub-containers [DataField] whose *contentInstance* contains the value of the Data Field. The ontologyRef attributes of the [DataField] container and its contentInstances are built analogously to 8.4.5.2.2.

The URI used to access a container resource whose contentInstance contains the value of a DataField has the following format:

[CSEBase]/[interface_container]/hasDataField/[dataField]

e.g.: IN-CSEID.m2m.myoperator.org/CSERoot/mySensorInterface/ hasDataField/myDataField

8.4.5.5.2 Linking the Interface to its Methods

The [interface_container] resource contains a sub resource of type <container> with the fixed name hasMethod that mirrors the relation *hasMethod* between the concepts *Interface* and *Method*.

The URI used to access this <container> resource has the following format:

[CSEBase]/[interface_container]/hasMethod

e.g.: IN-CSEID.m2m.myoperator.org/CSERoot/mySensorInterface/ hasMethod

The ontologyRef attribute of the hasMethod container has a value of:

http://[oneM2M_ontology] #hasMethod

or a more specific variant that is a sub-class of the *hasMethod* class in the oneM2M_ontology. This hasMethod container in turn has sub-containers [Method] whose contentInstances each holds a reference to a sub-container of the [Interface] container that represents one *Method* of the *Interface*.

The URI used to access a <container> resource whose contentInstance contains the reference to a [Method] container has the following format:

[CSEBase]/[interface_container]/hasMethod/[Method]

e.g.: IN-CSEID.m2m.myoperator.org/CSERoot/mySensorInterface/
hasMethod/readTemperatureMethod

8.4.5.5.3 Parameters of the Interface

The [interface_container] resource contains a sub resource of type <container> with the fixed name `hasInterfaceParameter` that contains the parameters for that interface.

The URI used to access this container resource has the following format:

[CSEBase]/[interface_container]/hasInterfaceParameter

e.g.: IN-CSEID.m2m.myoperator.org/CSERoot/mySensorInterface/ hasInterfaceParameter

The ontologyRef attribute of the `hasInterfaceParameter` container has a value of:

http://[oneM2M_ontology] #hasInterfaceParameter

or a more specific variant that is a sub-property of the *hasInterfaceParameter* property in the `oneM2M_ontology`.

This `hasInterfaceParameter` container in turn has sub-containers [interfaceParameter] whose contentInstances each contain the value of the respective parameter. The ontologyRef attributes of the [interfaceParameter] container and its contentInstances are built analogously to 8.4.5.2.2.

8.4.5.5.4 Methods of the Interface

[Interface] container that represents one *Method* of the *Interface*

Each [Method] sub-container of the [Interface_container] resource contains a sub resource of type <container> with the fixed name `hasMethodParameter` that contains the parameters for that Parameter of the method.

The URI used to access this container resource has the following format:

[CSEBase]/[interface_container]/hasMethodParameter

e.g.: IN-CSEID.m2m.myoperator.org/CSERoot/mySensorInterface/ hasMethodParameter

The ontologyRef attribute of the *hasInterfaceParameter* container has a value of:

http://[oneM2M_ontology] #hasMethodParameter

or a more specific variant that is a sub-property of the *hasMethodParameter* property in the `oneM2M_ontology`.

This *hasMethodParameter* container in turn has sub-containers [MethodParameter] whose contentInstances each contain the value of the respective parameter. The ontologyRef attributes of the [MethodParameter] container and its contentInstances are built analogously to 8.4.5.2.2.

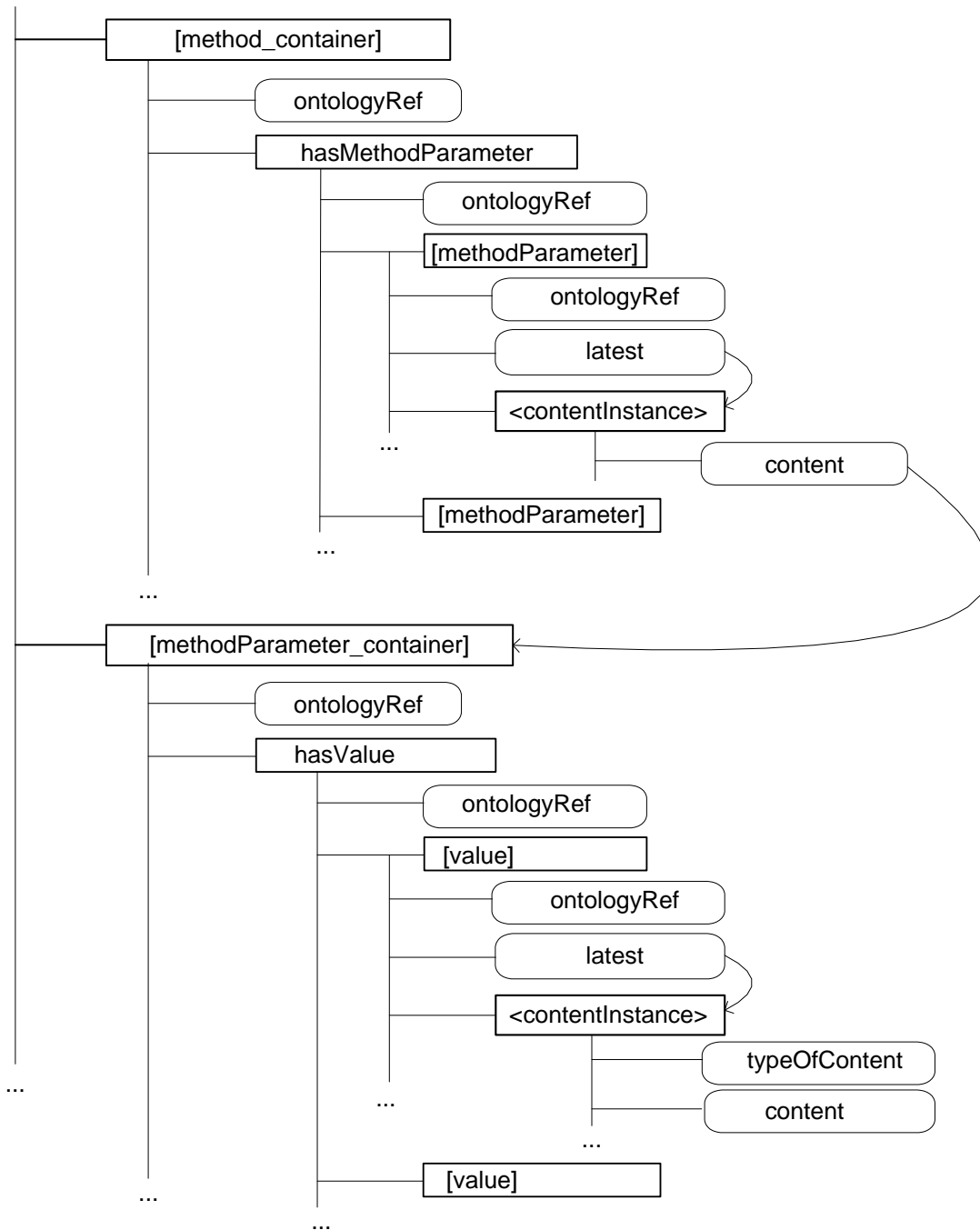

Figure 47:

9 Conclusions

In oneM2M Release 1 the current TR-0007 “Study on Abstraction and Semantics Enablements” resulted in a set of new use cases that rely on semantic support by oneM2M (Annex A). In addition the study collected Abstraction technologies and Technologies for a Semantic M2M System (sections 6 and 7). Section 8 contains a proposal how the oneM2M

System can be enhanced by including additional semantic capabilities. It contains design principles for modelling Devices, Things and their associations. Involvement of device manufacturers can be achieved through “Device Type Templates”. Section 8.4 proposes some specific modeling aspects for interworking with non-oneM2M devices and networks in support of Abstraction and Semantics in oneM2M.

In oneM2M Rel-1 only a very limited functionality that uses semantics is feasible. The only normative work related to semantics that had been performed was the introduction of the “ontologyRef” attribute for Application Entities (AEs), Containers and their Contentinstances.

Section 8.4 proposes a way how using this “ontologyRef”, together with appropriate ontologies that describe non-oneM2M Devices and Area Networks, interworking with those non-oneM2M Devices and Area Networks can already be facilitated in Release1. It provides a ‘cook book’ how Interworking Proxy Application Entities and related oneM2M resources can be constructed.

Thus, while not being normative in Rel-1, the method described in section 8.4 can be used as a guideline for specifying a defined interworking with non-oneM2M solutions. It is proposed that in future releases this method for interworking is being refined and will become normative.

In addition it is recommended that the work on the TR continues beyond Rel-1 and leads to normative work that will allow for more dynamic usage of semantic information like semantic discovery, reasoning or mesh-ups.

Proforma copyright release text block

This text box shall immediately follow after the heading of an element (i.e. clause or annex) containing a proforma or template which is intended to be copied by the user. Such an element shall always start on a new page.

Notwithstanding the provisions of the copyright clause related to the text of the present document, OneM2M grants that users of the present document may freely reproduce the <proformatype> proforma in this {clause annex} so that it can be used for its intended purposes and may further publish the completed <proformatype>.

<PAGE BREAK>

Annexes

Each annex shall start on a new page (insert a page break between annexes A and B, annexes B and C, etc.).

*Use the **Heading 9** style for the title and the Normal style for the text.*

Annex A: Use Cases (informative)

A.1 An example of Home Environment Monitoring Service using semantic mash-up

A.1.1 Description

Semantic mash-up provides functionalities to support new services through the creation of new virtual entities, which do not exist in physical world, by obtaining semantic information through semantic descriptions from existing M2M resources in the M2M System.

Semantic mash-up function in the M2M system may have the following advantages:

- **Communication efficiency:** By using virtual entities created through mash-up, M2M Applications can obtain necessary information by using only a single query to M2M system. It reduces communication overload between the M2M System and the applications.
- **Reusability:** Virtual entities created by mash-up can be used by multiple M2M applications. It can improve a reusability of information.
- **Authentication/security:** When a mash-up needs information of entities residing in several M2M systems, authentication/security issues can be solved by M2M systems rather than applications.

For mash-up, abstract entity is defined as follows:

- **Abstract entity:** a resource represented in the M2M System through the abstraction of either a physical entity or a functionality implemented as a software.

Virtual entity is a new resource created by a mash-up of multiple abstract entities. Additionally, it also includes a composite virtual entity created by the mash-up of either other abstract entities or existing virtual entities. It is manipulated as a general M2M resource.

Virtual entities can provide new information which the existing resources do not contain.

In general, the virtual entities are created in the M2M System by a query from a M2M Application. They can be created through the composition of other existing virtual entities as well as physical and abstract entities. The M2M System manages the created virtual entities.

For example, if a user in a home requests home environment information like Discomfort Index (DI) or Air Pollution Index (API), new virtual entity (i.e., 'Home Environment Management') is created through mash-up of data from home appliances (e.g., heater, air conditioner, humidifier, air cleaner, etc.) equipped with environment sensors (e.g., sensors for temperature, humidity, CO2 level, VOC(Volatile Organic Compound) level, etc.) in the home. The virtual entity-'Home Environment Management' provides users with DI or API calculated using average values of temperature, humidity, CO2 level or VOC level based on collected data from various environment sensors.

A1.2 Source (as applicable)

Modacom (TTA)

A1.3 Actors

- M2M Application: An application to provide a M2M application service based on M2M resources to M2M application service users.
- M2M System: A system to provide M2M service functions.
- Physical Device: A physical M2M appliance equipped with environment sensors (e.g., fan/heater, air conditioner, composite sensor, humidifier, air cleaner, etc.)

A.1.4 Pre-conditions

- A M2M System has capabilities for semantic processing.
- Physical entities and abstract entities for home appliances equipped with environment sensors are registered in a M2M System.
- A M2M resource has semantic description for semantic based searching and discovery.

A.1.5 Triggers (if any)

none

A.1.6 Normal Flow (as applicable)

The following Figure A.1 shows the procedure for creation and execution of a virtual entity for the request in case that a M2M Application sends a semantic query for DI or API.

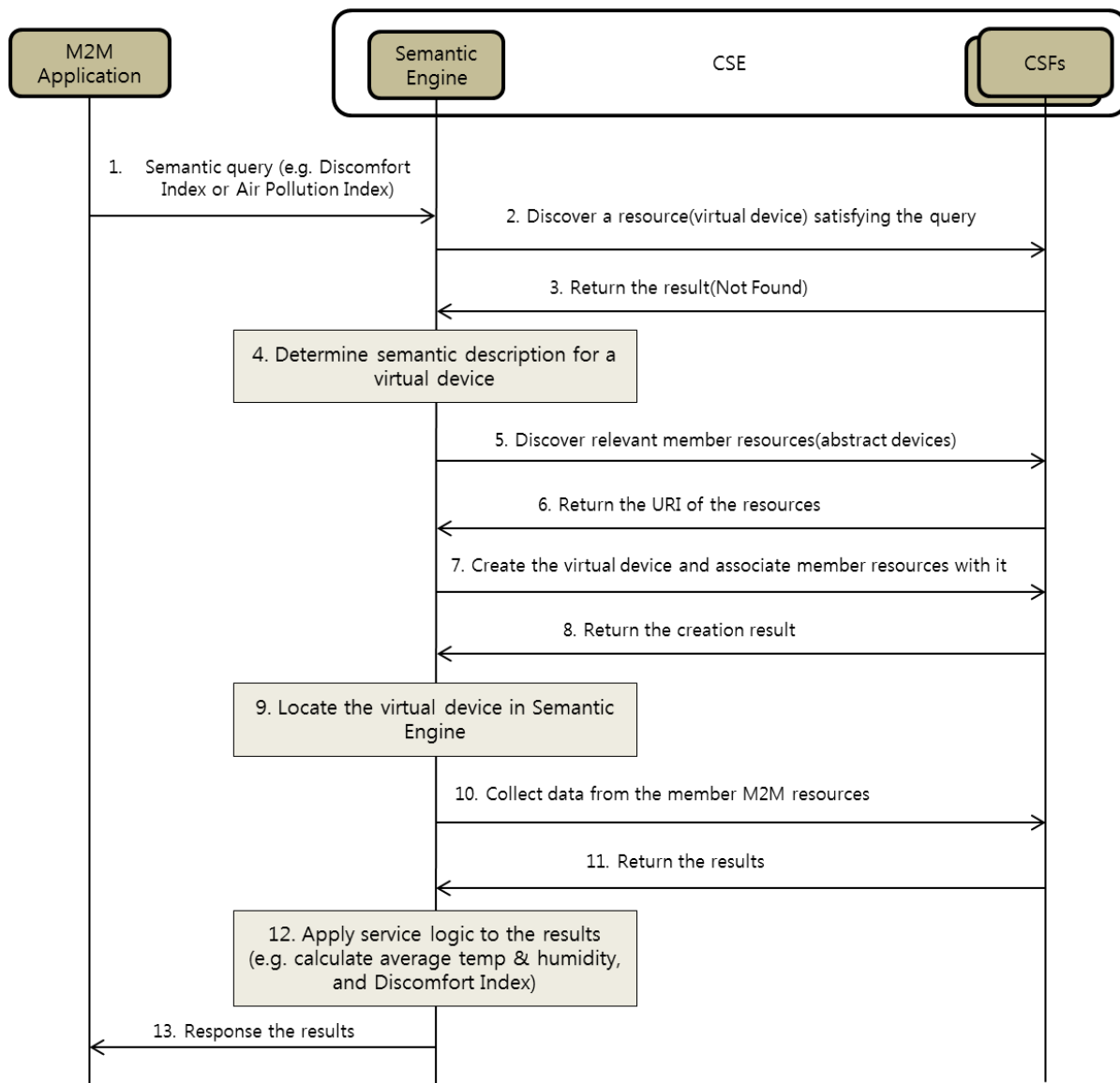

Figure A.1

1. A M2M Application sends a semantic query to a semantic engine in a M2M System (e.g., What's DI or API inside home?).
2. The Semantic Engine discovers virtual entity which can meet the semantic query in a CSE.
3. The CSFs return the result that there is no appropriate resource (Not Found).
4. The Semantic Engine determines semantic description to create a virtual entity (e.g., i) information of temperature and humidity required for calculating DI, ii) the method for calculating DI from data on temperature and humidity, etc.).
5. The Semantic Engine discovers related member resources (i.e., abstract entities).
6. The CSFs return URIs of discovered member resources.
7. The Semantic Engine requests to create a virtual entity and associate member resources with the virtual entity.
8. The CSFs return information for created virtual entity.
9. The Semantic Engine starts to run the virtual entity.

10. The Semantic Engine collects M2M data based on information from member resources of the virtual entity (e.g., values of temperature and humidity obtained from sensors in a home, etc.) .
11. The CSFs return the result.
12. The Semantic Engine applies a service logic using the collected values (e.g., the calculation of average temperature and humidity in a home, the calculation of DI value, etc.).
13. The Semantic Engine returns the result to the M2M Application (e.g., the current DI value inside home).

A.1.7 Post-conditions (if any)

none

A.1.8 High Level Illustration (as applicable)

In case that a M2M Application requests the information for DI or API, a M2M System creates a new virtual entity (i.e., 'Home Environment Management') through mash-up of related data after analysing the request and identifying required data. DI and AI are created as new attributes inside the 'Home Environment Management' virtual entity. To find a DI value, a Semantic Engine inside the M2M System calculates average values of temperature and humidity from the data obtained through mash-up. After that, the DI value calculated from the average values is provided to the M2M Application. Similarly to DI, the API value is also calculated through mash-up of data for CO₂, VOC level and is provided to the M2M Application.

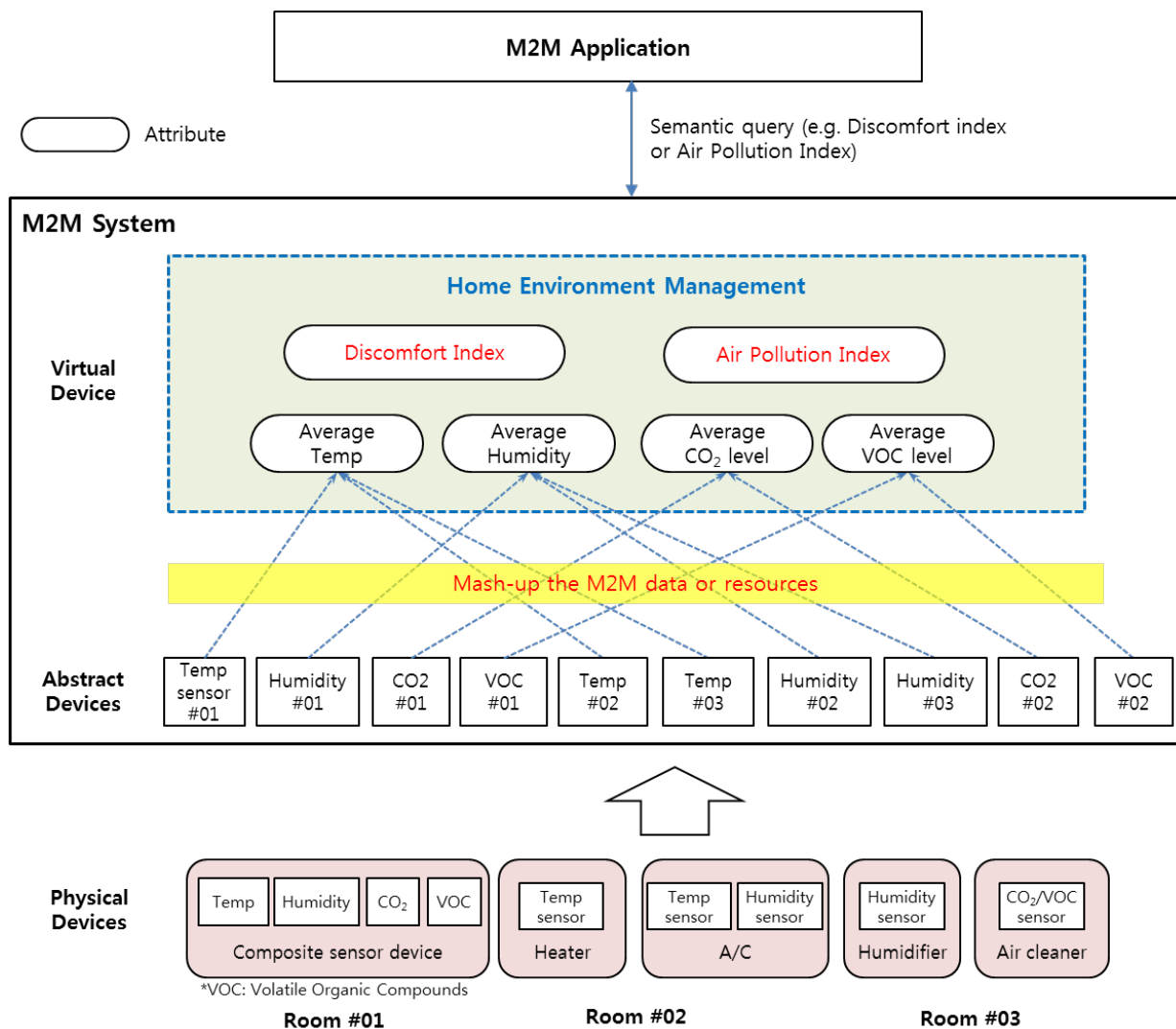

Figure A.2

A.2 Semantic Home Control

A.2.1 Description

The Semantic Home Control use case has been described in the oneM2M Use cases collection (see [i.29], Section 9.6). The complete use case description will not be repeated here. Instead the semantic aspects of it will be detailed. This includes an example of how the semantic aspects could be modelled and how the use case could be realized on this basis.

In the use case, there are two applications, a building management system (BMS) and a home energy management system (HEMS). The BMS has knowledge about all structural elements of the building, i.e. the apartments, rooms, doors, windows, etc. as well as equipment installed in the house like heaters, air conditioning systems, etc. The HEMS configures itself for a given apartment based on the information available in the BMS. This means it has to find out about the rooms and the heaters and air conditioning systems deployed there in order to control the temperature in the apartment.

In the following, we give an example how the use case could semantically be modelled based on an OWL [i.26] ontology. The example is used to illustrate the semantic approach – it is not claimed to be complete and there are surely other modelling options.

Figure A.3 shows the semantic concepts of Thing Type, i.e. describing real world things, modelled as ontology concepts. The relation between building and apartment, i.e. hasApartment, and the relation between apartment and room, i.e. hasRoom, are modelled as object properties of the ontology and are shown as dashed arrows in Figure A.3.

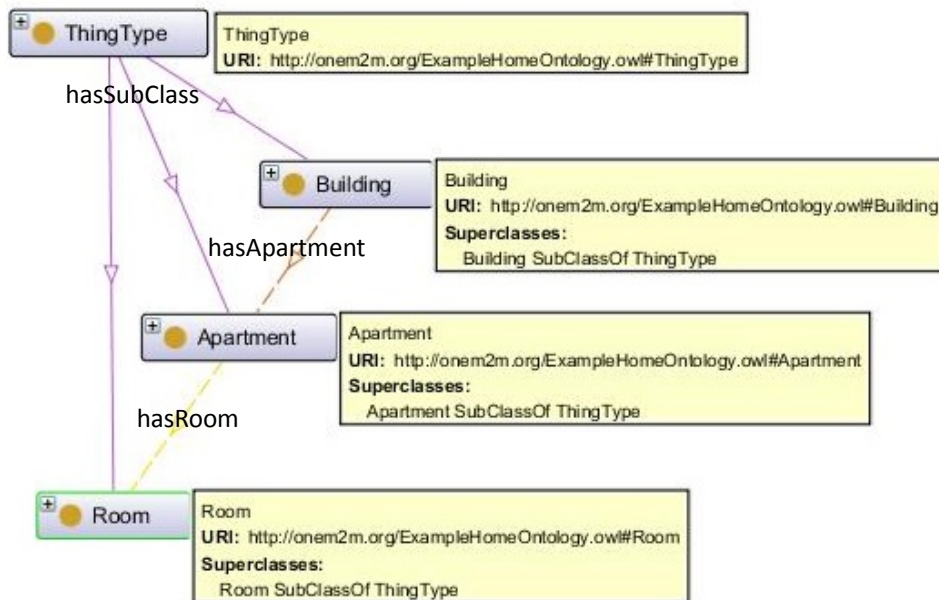

Figure A.3: Thing Types describing the structural elements of the building

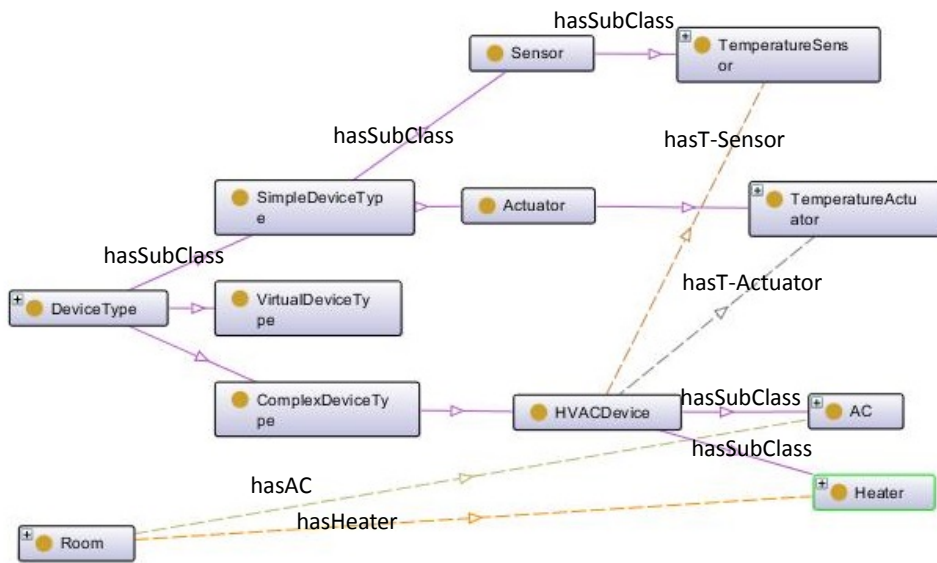

Figure A.4: Device Types describing the devices relevant for the HEMS

Figure A.4 shows the concepts of DeviceType, which are relevant for the HEMS. The Device Type has SimpleDeviceType, ComplexDeviceType and VirtualDeviceType as subclasses. A SimpleDeviceType can either be a Sensor or an Actuator. Relevant for HEMS are the TemperatureSensor and TemperatureActuator types. ComplexDeviceTypes represent more complex devices, which may contain simple devices. For the HEMS case, there are HVAC (heating, ventilation, air conditioning) devices, which contain temperature sensors and temperature actuators. The specific devices used are heaters and ACs (air conditioning systems). They inherit their relations to temperature sensors and actuators from the HVAC Device Type. VirtualDeviceTypes represent virtual devices, i.e. entities that can be accessed in the same way as real devices, but only consist of software. Virtual devices can be used to provide processed information, e.g. an average calculated from the output of a number of physical devices.



Figure A.5: Visualization of example instances for HEMS use case.

Figure A.5 shows a visualization of example instances for the HEMS use case. Two apartments have been modelled with different levels of details. In Apartment 1 only the two main rooms are covered, whereas Apartment 2 provides the details for all the rooms. Icons also indicate which rooms where the heaters and ACs are installed.

Figure A.6 shows the ontology model corresponding to the visualization shown in Figure A.5.

In addition to relationships among types it shows instantiation of the individual types (as “hasIndividual” relationship).

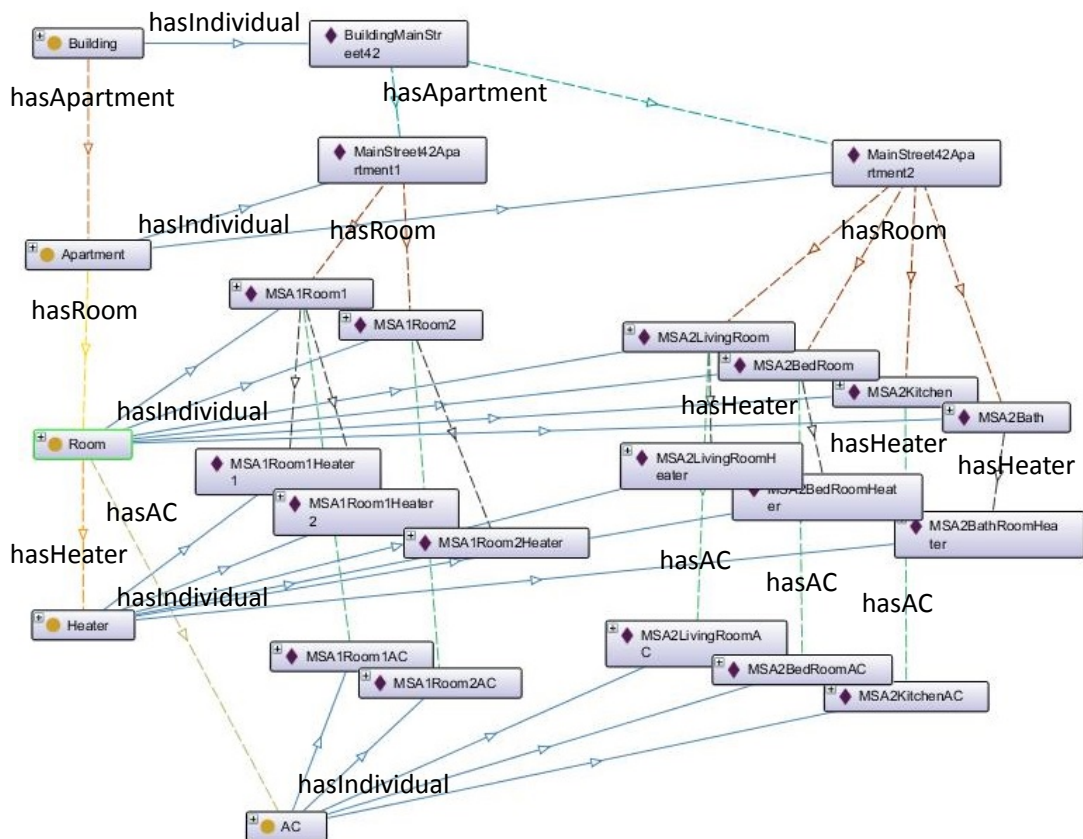

Figure A.6: Ontology model with instances

Given that the Ontology shown above is available in a triple store [i.28], the following SPARQL [i.27] queries can be executed to find the rooms and devices that the HEMS application needs in order to control the temperature in apartment 2 of building Main Street 42.

PREFIX home: <http://onem2m.org/ExampleHomeOntology.owl#>

SELECT ?room

WHERE { home:MainStreet42Apartment2 home:hasRoom ?room .

}

room
MSA2BedRoom
MSA2LivingRoom
MSA2Bath

MSA2Kitchen

With the following query, the heaters and ACs for the respective rooms can be found:

PREFIX home: <http://onem2m.org/ExampleHomeOntology.owl#>

SELECT ?room ?ac ?heater

```
WHERE { home:MainStreet42Apartment2 home:hasRoom ?room .  
  OPTIONAL { ?room home:hasAC ?ac }  
  OPTIONAL { ?room home:hasHeater ?heater }  
}
```

room	ac	heater
MSA2BedRoom	MSA2BedRoomAC	MSA2BedRoomHeater
MSA2LivingRoom	MSA2LivingRoomAC	MSA2LivingRoomHeater
MSA2Bath		MSA2BathHeater
MSA2Kitchen	MSA2KitchenAC	

Given the ACs and the Heaters, the respective temperature sensors and temperature actuators can be found, e.g.

PREFIX home: <http://onem2m.org/ExampleHomeOntology.owl#>

SELECT ?temp_sensor ?temp_actuator

```
WHERE { OPTIONAL { home:MSA2BedRoomHeater  
home:hasTemperatureSensor ?temp_sensor }  
  OPTIONAL { home:MSA2BedRoomHeater  
home:hasTemperatureActuator ?temp_actuator }  
}
```

temp_sensor	temp_actuator
MSA2BedRoomHeaterTemperatureSensor	MSA2BedRoomHeaterTemperatureActuator

A.2.1 Source

NEC (ETSI)

A.3 Gym Use Case

A.3.1 Description

In the gym use case, as shown in Figure A.7 and Figure A.8, a gym local area network is set up to provide capabilities enabled locally or, by a Service Provider, via a Service Layer, with which the gym CSE registers at set-up. Devices available in the area network host various applications and are used to enable services. For example, treadmill applications and ambient sensor applications discover the local network and register with it.

The local area network capabilities are used by the users/gym members through devices like a phone, which discover the network and connect to the Service Layer when the member/user arrives. The member also uses devices such as a watch to collect biometric data (pulse, blood pressure, etc.) and feed it to the phone, which might use it within different applications. In this use case an application from the insurance company gathers data to give him points for staying in shape, and another gym-specific application is used to find and schedule available training devices (such as treadmills) or as personal trainer to monitor goals.

In order for the gym application on the phone able to discover and select available training devices, their semantic descriptions should be known to the gym application.

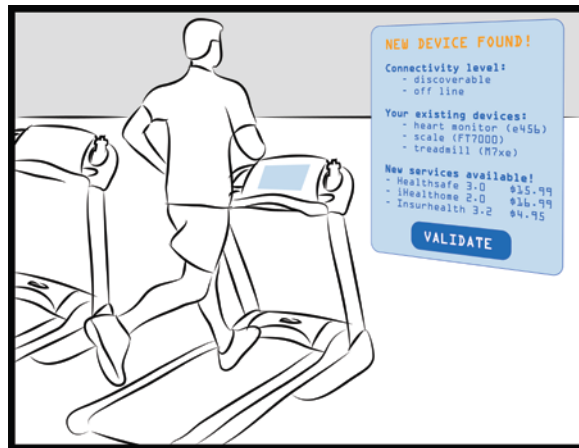

Figure A.7: Gym Use Case

Similarly, the health insurance application on the phone collects biometric measurements from the watch. It also collects the data from the gym ambient sensors (e.g. temperature, humidity), and the finished gym training program from the used training device via the gym CSE. The health score of the user can be calculated only based on the collected data and its associated semantics.

The health insurance application on the phone shares its information with the health insurance company application, which can determine and adjust the user's insurance premium based on it. In order to let the health insurance company application have the same interpretation of the data, the semantics of those resources need to be appropriately added and enabled.

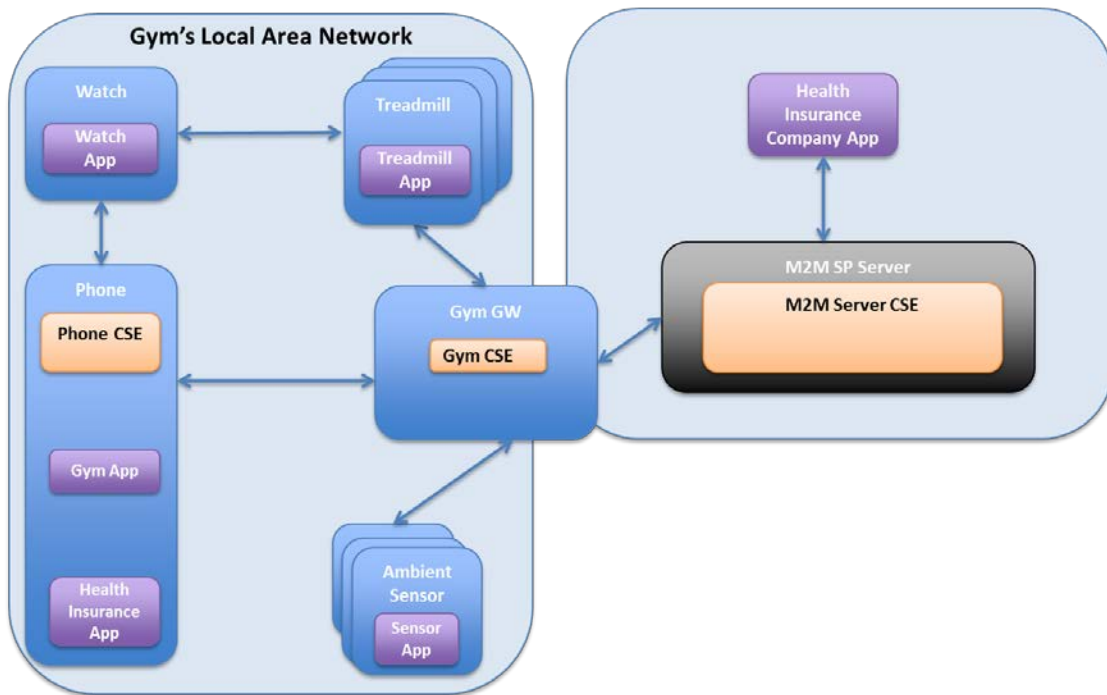

Figure A.8: Gym Use Case Architecture

In Figure A.9, we give the ontology model of the gym use case. In Figure A.10, we give the ontology model of the treadmills in the gym.

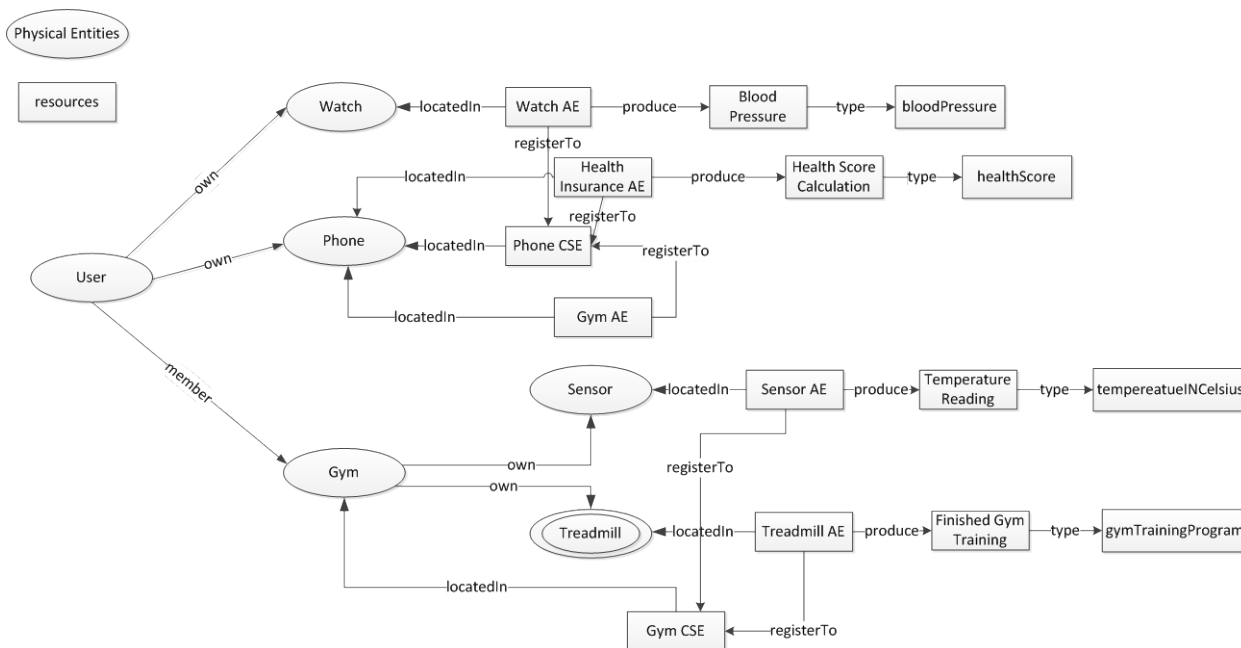

Figure A.9: Ontology Model of Gym Use Case

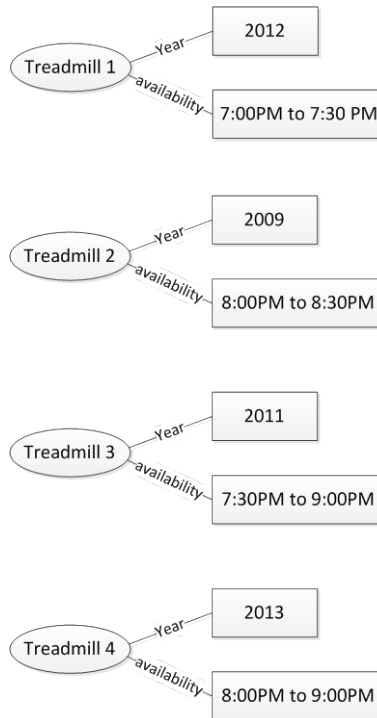

Figure A.10: Ontology Model of Treadmills

A.3.2 Source

InterDigital Communications

A.3.3 Actors

- Gym area network: The local area network in the gym that provides Internet connection to the gym members' personal devices.
- Ambient sensors: The ambient sensors that are deployed in the gym to measure the environmental parameter in the gym, such as the temperature, humidity.
- Training devices: The training devices that are deployed and available in the gym for the gym members, such as treadmills, elliptical.
- Gym member: The members of the gym who consumes services provided by the gym owners, such as the training devices, gym applications, network connection to their personal wireless devices.
- Gym member's personal wireless devices: The personal wireless devices that are carried with the gym member into the gym, such as phone, watch, which can measure the person's vitals, collect the person's training data, and calculate the person's health score.
- Health insurance company: The health insurance company provides service to its members for any health insurance related information as well as keeps track of the members' gym training history and health scores.
- M2M service platform: Gym and health insurance system host which collects, stores, manages and processes data from the user's devices, the training devices used by the user. It accepts registration from the service providers (gym owner, health insurance company) and the users' personal devices. It accepts/enforces policies governing data exchange and access from the M2M Service Providers.

A.3.4 Pre-conditions

The person has membership contract with the gym service provider, the health insurance provider. The gym service provider and the health insurance provider have business relationship with the M2M Service Provider.

The M2M Service Provider provides the mechanisms to govern the data exchange and access.

A.3.5 Triggers

A variety of triggers might be associated with the use case, for examples see flow.

A.3.6 Normal Flow

See Figure A.12 below

- 1), 4), 6), 9) AEs register to the CSEs: watch AE, health insurance AE, gym AE on the phone registers to the phone CSE; ambient sensor AEs and device AEs (e.g. treadmills) register to the gym CSE. The registration message includes semantics associated with each application.
- 2), 5), 7), 10) Applications create resources to store measurement data in the phone CSE and gym CSE. The semantics of the data needs to be published by the corresponding application as well, which may be linking to other resources on other locations such as the semantics repository. In order to understand it, the relevant resource representation needs to be retrieved by the phone CSE, gym CSE.
- 3), 8), 11) Semantics relevant resources to the newly created resources (AEs, measurement resources) are retrieved by the phone CSE, gym CSE and made available. Resources will be made available together with the context included in resource representation and associated semantics. The phone CSE and the gym CSE are able to parse and interpret the newly created resources, and support semantics-based query on those resources.
- 12) Registered applications request actions based on available resources. In this case the gym application on the phone can query which treadmill will be unoccupied for a certain period of time.
- 13) The gym CSE provides a value added service using semantics, for example through the treadmill availability query. From the OWL ontology shown in Figure 4, the following SPARQL queries can be processed to find the treadmills that are available from 8:00PM to 8:30PM. The query and its result are shown in Figure A.11 and Table A.1.

```
PREFIX gym:<coap://example.org/gym.owl#>

PREFIX xsd: <http://www.w3.org/2001/XMLSchema#>

SELECT ?treadmill

WHERE {

?treadmill gym:availability ?availability .

FILTER(?availability >= 20:00:00^^xsd:time && ?availability <= 20:30:00^^xsd:time ) .

}
```

Figure A.11: Query



treadmill2
treadmill3
treadmill4

Table A.1: Query Result

- 14) The response to the semantics-based query is returned; in this case the query response may include the URI of the resources and associated semantics.
- 15) The requesting application uses the response to the query, including the semantics associated with the resources in the response.
- 16) An application subscribes to data stored on the gym CSE and the phone CSE. Subscribed data such as ambient sensor measurements, user biometrics and finished gym training program are collected.
- 17), 20) The subscribing application retrieves the relevant resource representation as well as its associated semantics from the gym CSE and the phone CSE. The resource associated semantics may link to other resources on the semantics repository, which need to be retrieved as well in order to provide data analysis. The semantic descriptions are parsed and interpreted.
- 18), 21) The application uses the data and associated semantics for analysis and computation.
- 19) An application subscribes to data stored on the gym CSE and the phone CSE. Subscribed data such as the health score computed by the health insurance application, the user finished gym training program.

A.3.7 Post-conditions

N/A

A.3.8 High Level Illustration

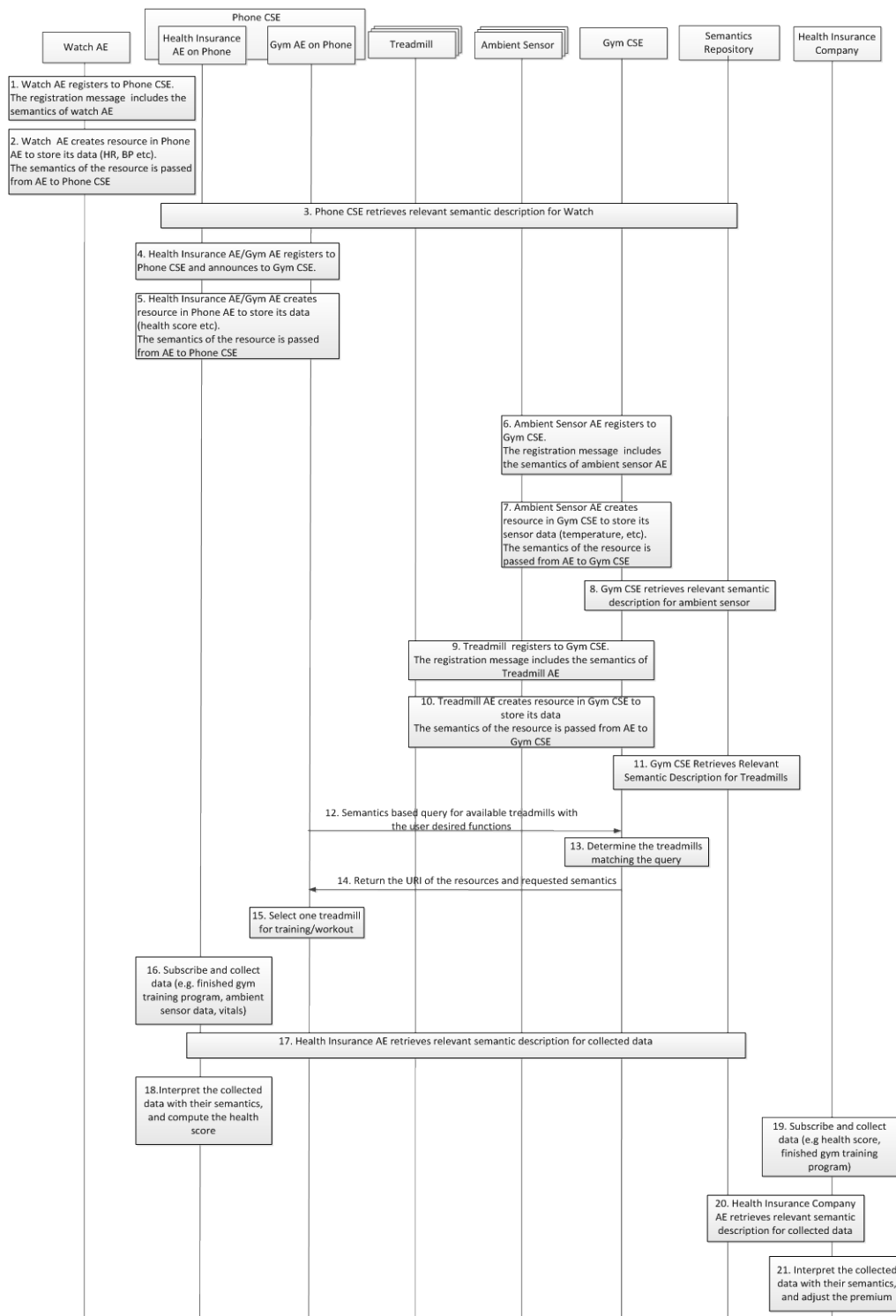

Figure A.12: Normal Flow

A.3.9 Potential requirements

- The M2M System shall provide the capability to publish semantic descriptions.
- The M2M System shall support parsing and interpreting semantic descriptions.

- The M2M System shall support resource discovery based on semantics.

References:

This use case refers to documents in [22], [30], [31], [32], [33], [34], [35]

A.4 Intelligent Alarm Service using Semantic Discovery and Mash-up

A.4.1 Description

Intelligent Alarm Service, as shown in Figure A.13, provides a user with a context-aware alarm service by a smart phone. The smart phone searches neighbouring nodes in order to find and select possible nodes to participate in the Intelligent Alarm Service. The selected nodes make a group. The group members consist in a smart phone, a smart TV, a smart audio device, and a camera in Figure A.13. They collaborate with each other based on service logic information provided by a service provider. It also provides a mash-up service according to user's behaviour patterns.

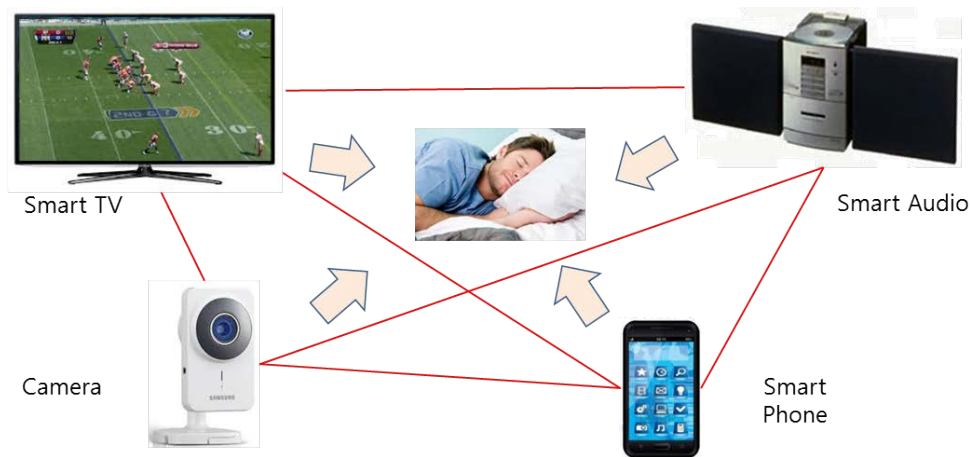

Figure A.13: Intelligent Alarm Service Use Case

The Intelligent Alarm Service can be provided based on two scenarios below.

Case#1: In the case of the user set up the alarm service on the smart phone in advance,

- At a designated time, the smart phone rings an alarm and a camera monitors the user and notifies the neighbor nodes of the user's status.
- If the user does not wake up the camera sends the status information to the smart TV and the audio device to request for the cooperation.
- Then the smart TV turns on and audio device plays the user's favorite music.

Case#2: In the case of the user did not set up the alarm service on the smart phone in advance,

- The smart phone checks the user's schedule information in the phone
- Base on the morning schedule, the smart phone rings an alarm at the suitable time automatically.

Figure A.14 shows the system architecture of the Intelligent Alarm Service.

All nodes register abstract entities (such as AEs, abstract entities representing physical entities) to local ASN-CSEs. And then all nodes also register abstract entities to semantic information repository via a semantic engine in MN/IN-CSE including the device and service profile information. For the discovery and mash-up of the associated entities, the IntelligentAlarmService, a virtual entity in the smart phone, requests a semantic query to the semantic information repository, obtains the associated abstract/virtual entities resources and analyses the results to select participating nodes.

The associated abstract entities (IntelligentAlarmService, HumanMonitoringService, SmartTVService, SmartAudioService) in the participating nodes (i.e., Camera, smart TV, smart audio device) fulfil the announcement and subscription of the associated resources in ASN-CSEs. The nodes notify the events with each other when related events occur in the nodes and provide the mash-up service through cooperation among the node's own services.

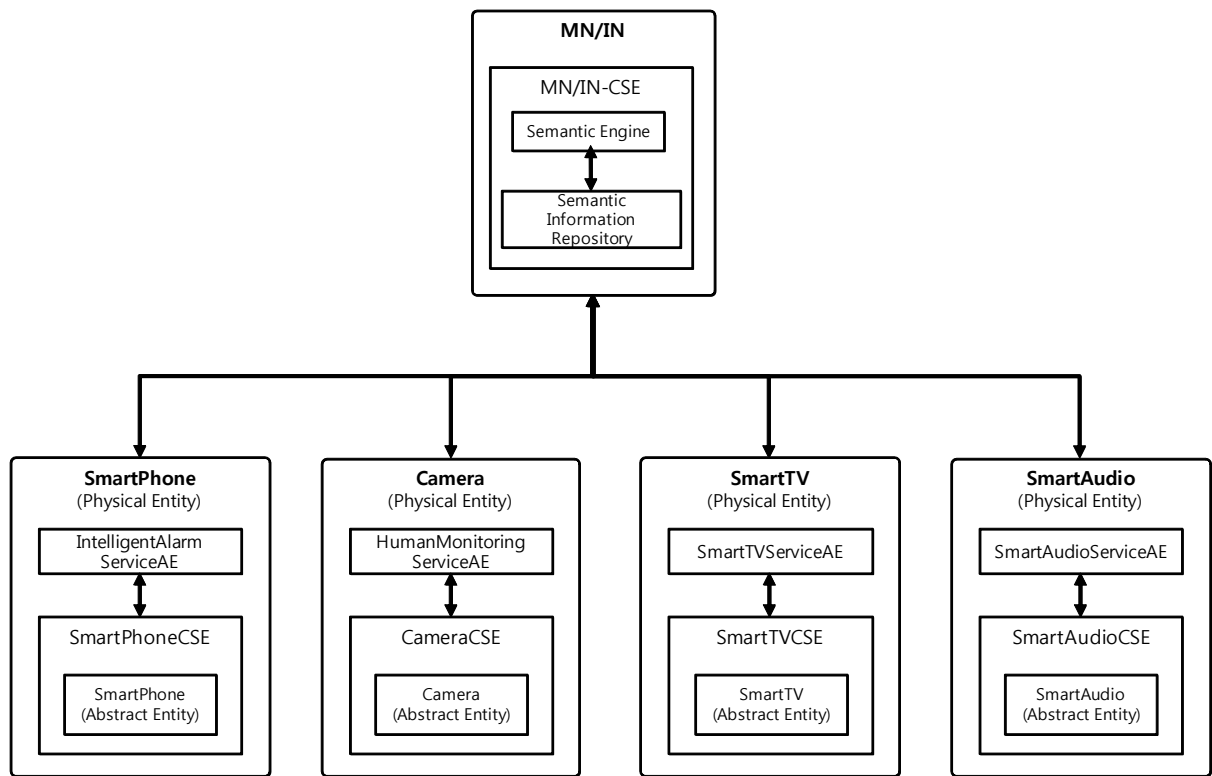

Figure A.14: System Architecture of Intelligent Alarm Service Use Case

Figure A.15 shows the ontology model for the Intelligent Alarm Service Use Case in oneM2M system.

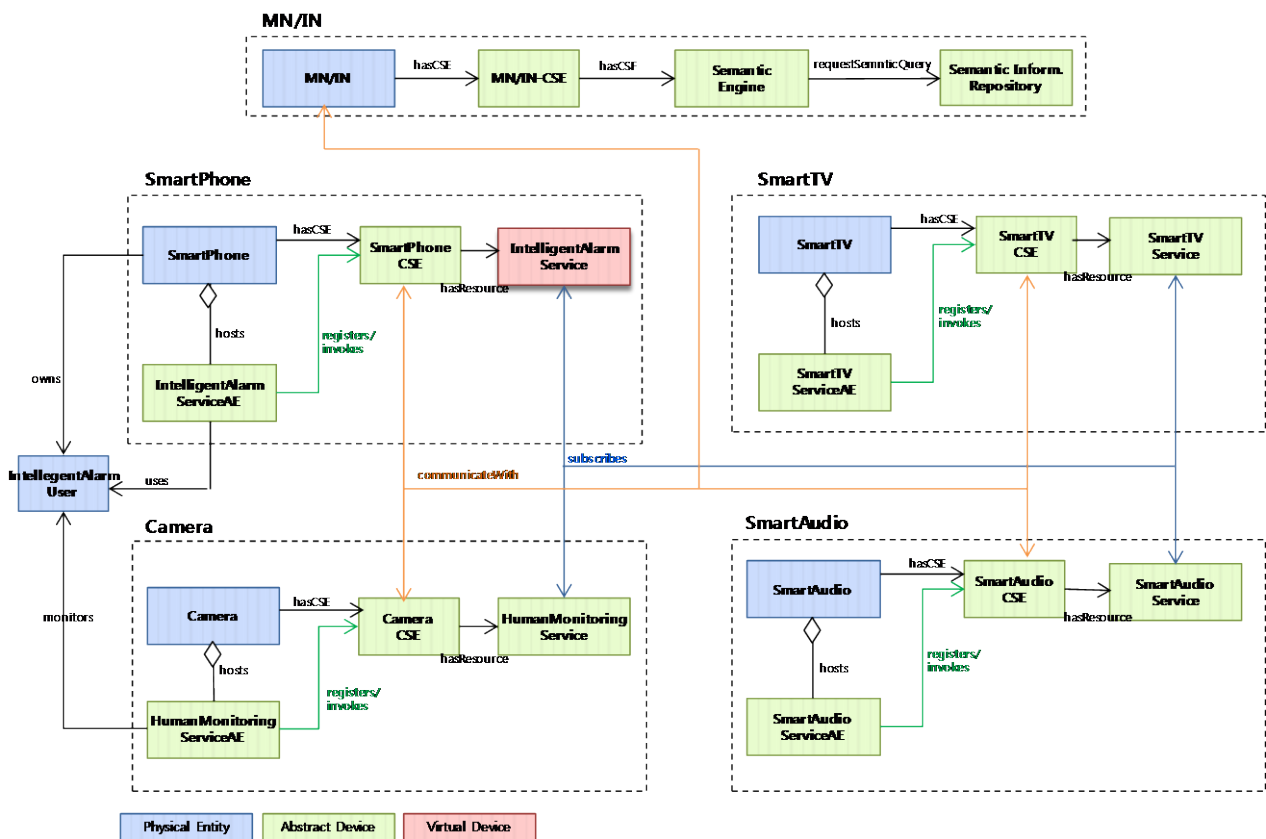

Figure A.15: Ontology model for the Intelligent Alarm Service Use Case

The oneM2M domain model consists of three primary classes whose definitions are as follows:

- Physical Entity: a tangible element that is intrinsic to the environment, and that is not specific to a particular M2M application in this environment. Depending on the environment, the physical entity may be a smart phone, a camera, a smart TV/audio, a piece of furniture, somebody, a room of a building, a car, a street of a city, etc.
- Abstract Entity: A resource represented in the M2M System through the abstraction of either a physical entity or functionality implemented as software.

Note: an Abstract Entity relates to “Thing” and “Thing Representation”:

Thing: an element of the environment that is individually identifiable in the M2M system.

Thing Representation: It is the instance of the informational model of the Thing in the M2M System. A Thing Representation provides means for applications to interact with the Thing.

- Virtual Entity: A new resource created by a mash-up of multiple abstract entities. Additionally, it also includes a composite virtual entity created by the mash-up of either other abstract entities or existing virtual entities.

Note: an Abstract Entity relates to “Virtual Thing” as described in section 7.2.1.3

A.4.2 Source

Modacom (TTA)

A.4.3 Actors

- M2M Application: An application to provide a M2M application service based on M2M resources to M2M application service users.
(i.e. IntelligentAlarmServiceAE, HumanMonitoringServiceAE, SmartTV/AudioServiceAE)
- M2M System: A system to provide M2M service functions.
(i.e. SmartPhoneCSE, CameraCSE, SmartTV/AudioCSE, MN/IN-CSE)

A.4.4 Pre-conditions (if any)

N/A

A.4.5 Triggers

The service is triggered when a user either set up the alarm or registers one's schedule information on one's smart phone with service logic for Intelligent Alarm Service.

A.4.6 Normal Flow

Figure A.16 displays the flow diagram of the Intelligent Alarm Service Use Case.

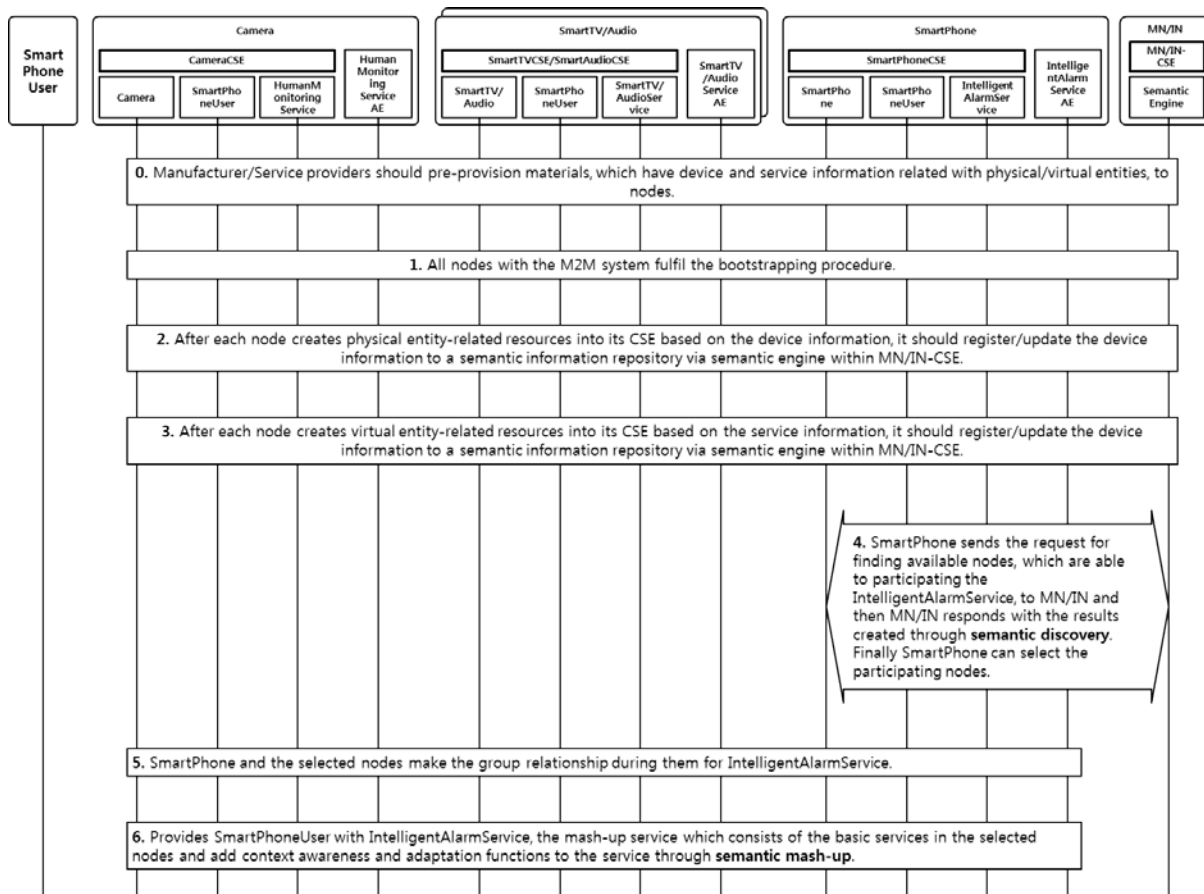

Figure A.16: High Level Flow Diagram of Intelligent Alarm Service

0. Nodes are provided with some pre-provisioned materials such as a semantic description containing the device and service information related with Physical/Abstract Entities.
1. The M2M System takes the procedure of bootstrapping and initialization.
2. After creating physical entity-related resources into their local CSEs with the device information, all nodes register or update their device information to a semantic information repository via a semantic engine within MN/IN-CSE (Middle Node/Infrastructure Node – Common Service Entity).
3. After creating virtual entity-related resources into their local CSEs with the service information, all nodes register or update their service information to a semantic information repository via a semantic engine within MN/IN-CSE.
4. The smart phone searches for the nodes which are possible to attend the Intelligent Alarm Service.
 - a. After the smart phone extracts the information for discovering the nodes which are possible to join the Intelligent Alarm Service from the device and service information, it sends the request of semantic query to MN/IN.
 - b. The MN/IN fulfils **the semantic discovery** before responding to the requester with the searching results of the associated nodes.
 - c. Parsing and analyzing the results, the smart phone chooses the nodes possible to attend. (i.e., camera, smart TV and smart audio)

5. With the selected nodes cooperating with each other, they organize the group to join the Intelligent Alarm Service.
 - a. The selected nodes mutually register to each other.
 - b. The selected nodes take the action of announcement to interesting resources. The smart phone announces SmartPhone/IntelligentAlarmService/SmartPhoneUser resources to other selected nodes, The smart TV and smart audio to SmartTV/SmartAudio/SmartTVService/SmartAudioService ones and the camera to Camera/HumanMonitoringService ones.
 - c. The selected nodes subscribe to the interesting resources to be notified of the changes of ones. The smart phone, smart TV and smart audio subscribe to the HumanMonitoringService resource.

6. The selected nodes provide the Intelligent Alarm Service to SmartPhoneUser through **the semantic mash-up** and cooperatively perform their own basic service in accordance with the service information. The smart phone informs the selected nodes (i.e., camera, smart TV and smart audio) of the information of the alarm service related with SmartPhoneUser. The camera monitors the status of SmartPhoneUser and notifies the selected nodes of the events' information. According to the status information of SmartPhoneUser, the smart TV and audio analyzes the accumulated information on SmartPhoneUser (e.g., user's favorite channels and music) and provide the context-adaptive alarm service to SmartPhoneUser.

A.4.7 Post-conditions (if any)

None

A.4.8 High Level Illustration (as applicable)

None

A.4.9 Potential requirements (as applicable)

- The M2M System shall provide capabilities to represent device and service information using ontology for service discovery, mash-up and data analysis.

A.5 Semantic Home Automation Control

A.5.1 Description

This use case demonstrates the semantic home automation control system. The system consists of home automation APP, smart household appliances, and M2M service platform as shown in the following Figure A.17.

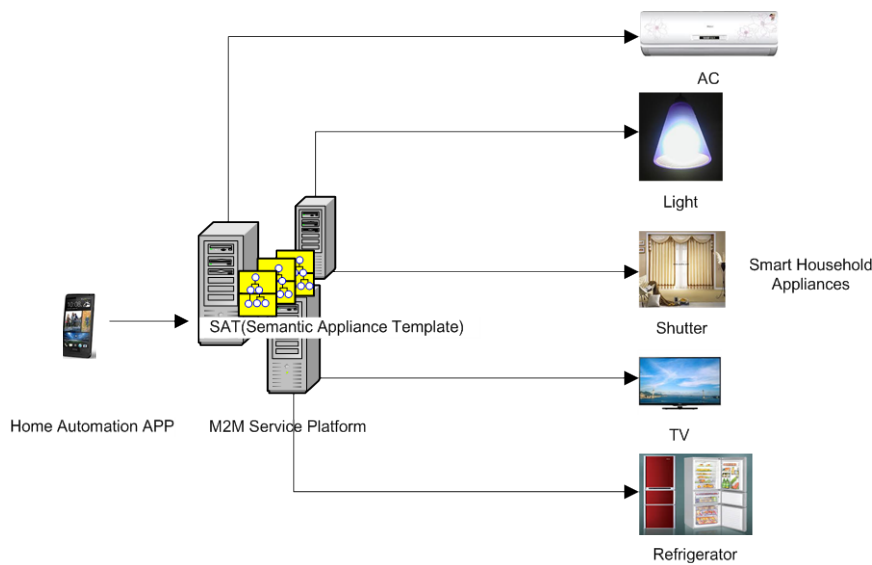

Figure A.17: Semantic Home Automation Control System

The system user can install the home automation APP on the user device e.g. the smart mobile terminal. The user device with the installed the home automation APP can control smart household appliances including AC, light, shutter, AC, TV and refrigerator, etc. The various appliances information including e.g. appliance ID, appliance type, operation and data types, etc. can be modelled as SAT (semantic appliance template). The user sends control command in the form of natural language to the APP, e.g. by texting “tune the air conditioner in the living room to 22 centigrade”. The APP converts the natural language control command and generates e.g. SPARQL semantic query [i.27]. The APP then sends SPARQL semantic query to the M2M service platform. In this use case, the M2M service platform provides the semantic functionalities with which semantic query can be executed to locate the desired appliance, i.e. AC in the living room, and get the appliance semantic information including, e.g. appliance ID, appliance type, operation and data types from the SAT (semantic appliance template).

The APP can then generate the appliance control command by using the appliance semantic information and send the appliance control command to the desired smart household appliance.

A.5.2 Source

Haier (CCSA)

A.5.3 Actors

- Home Automation APP: is an M2M application for home automation control
- M2M Service Platform: provides semantic appliance service for home automation control
- Smart Household Appliance: is the household appliance with remote control feature

A.5.4 Pre-conditions

The M2M service platform contains all the necessary information to manage the whole smart household appliances of the user if it is allowed. It in particular contains the details of the smart household appliances including the location of the appliances and their capabilities, etc.

The M2M APP can generate SPARQL semantic query to retrieve the semantic appliance information from the M2M service platform.

The smart household appliance can interact with the M2M service platform which can execute the appliance control command and send back the appliance status.

A.5.5 Triggers

None

A.5.6 Normal Flow

The following figure provides the basic flow of semantic home automation control.

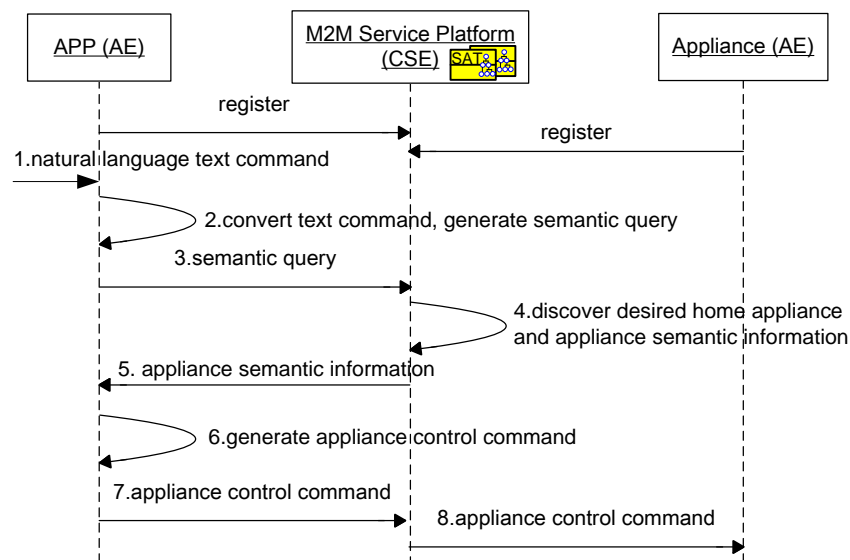

Figure A.18: Semantic Automation Home Control Flow

1. The APP receives the natural language control command, e.g. “tune the air conditioner in the living room to 22 centigrade”.
2. The APP converts the natural language control command and generates semantic query e.g. SPARQL semantic query.
3. The APP sends semantic query to the M2M service platform.
4. The M2M service platform executes the semantic query to locate the desired appliance, i.e. AC in the living room, and get the appliance semantic information including e.g. appliance ID, appliance type, operation and data types from the appliance semantic description.
5. The M2M service platform sends the appliance semantic information to the M2M APP.
6. The M2M APP generates the appliance control command by using the appliance semantic information.
7. The APP sends the appliance control command to the M2M service platform.
8. The M2M service platform delivers the appliance control command to the AC.

A.5.7 Post-conditions

None

A.5.8 High Level Illustration

This use case applies home automation ontology model for semantic information sharing. The following figure illustrates the logical view of ontology-based model to specify the semantic information of smart household appliances and their relationships.

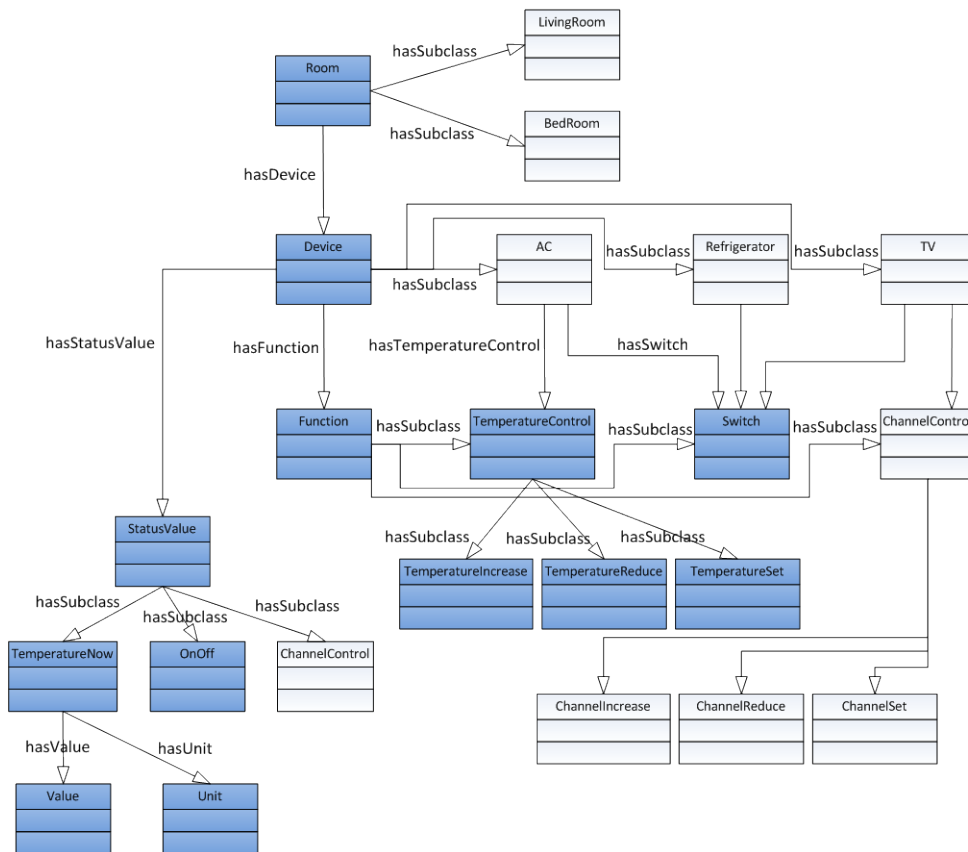

Figure A.19: Home Automation Ontology Model

The basic information of this ontology model is described as follows.

- AC is an appliance which has there functions including controlling temperature (TemperatureControl) and switch (Switch).
- TemperatureControl function consists of three sub-functions including temperature increasing (TemperatureIncrease), temperature reducing (TemperatureReduce) and temperature setting (TemperatureSet).
- Switch function set the AC into working time running mode or out of working time running mode.
- TemperatureIncrease sub-function increases AC temperature.
- TemperatureReduce sub-function reduces AC temperature.
- TemperatureSet sub-function set AC temperature.
- StatusValue is a record to represent the current appliance status including current temperature (TemperatureNow), on-off state (OnOff) and current channel (ChannelControl).
- TemperatureNow is a status value to record the current temperaturewhich consists of value and unit.
- OnOff is a status value to decide the working time of the AC.

The following figure illustrates the instance of semantic home automation ontology according to the ontology-based model. Given the home automation ontology model, the APP can locate the desired appliance through semantic query.

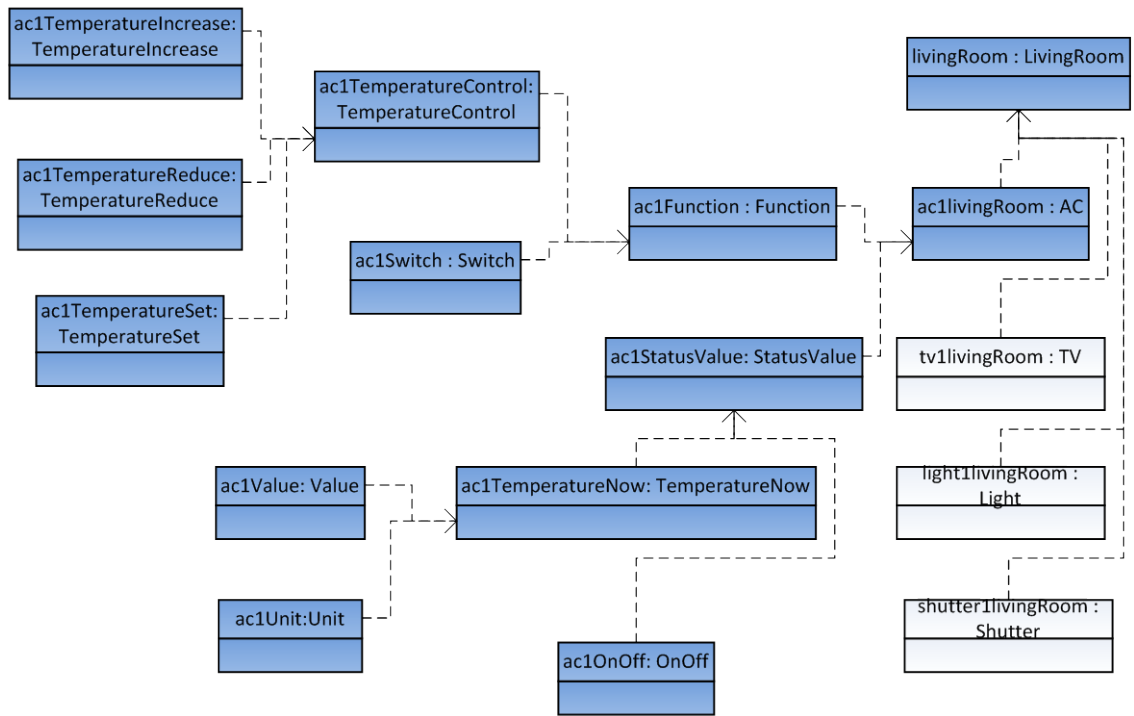

Figure A.20: Home Ontology Model with AC Instances

A.5.9 Potential requirements

The M2M system shall be able to support semantic modelling device template for diverse M2M devices (e.g. household appliances).

The M2M System shall support common ontology to model the semantic information of M2M devices and the real-world entities (e.g. rooms) that associate with M2M devices.

The M2M System shall support semantic query to enable the discovery of target M2M devices based on their semantic information.

A.6 Semantic smart building light control

A.6.1 Description

The smart building light control use case has been mentioned in the oneM2M use case collection (see [i.29]. section 6.1) from group management aspects. In this contribution, we describe the smart building light control use case from semantic aspects. The light control for one target room is given as an example.

In the use case, all the smart building appliances are connected with M2M gateway. M2M gateway and Smart building control centre are connected with oneM2M platform. The light control application sends the semantic query request to the smart building control centre to find the desired appliances.

In the following, we show how the use case could semantically be modelled based on OWL [i.26] ontology. There are two ontologies involved in this use case. One ontology is a basic M2M ontology named **ontology A**, which is referred by all actors (e.g. oneM2M platform, smart building control centre and light control application). The other ontology is a specific ontology on light domain named **ontology B**, which is referred by light control application.

Note that ontology A and ontology B are compatible ontologies in this use case, which indicates that there exists corresponding relationships between the same concepts (that may corresponding different vocabularies) in ontology A and ontology B. The compatibility can be realized in the ways such as

- 1) Ontology B refers to ontology A and use the vocabularies in ontology A to describe same concepts, or vice versa.
- 2) There are some triple stores [i.28] to express corresponding relationships (e.g. be equivalent to) between the vocabularies in ontology A and ontology B. Some techniques can be deployed for ontologies mapping

In this use case, the first way is adopted.

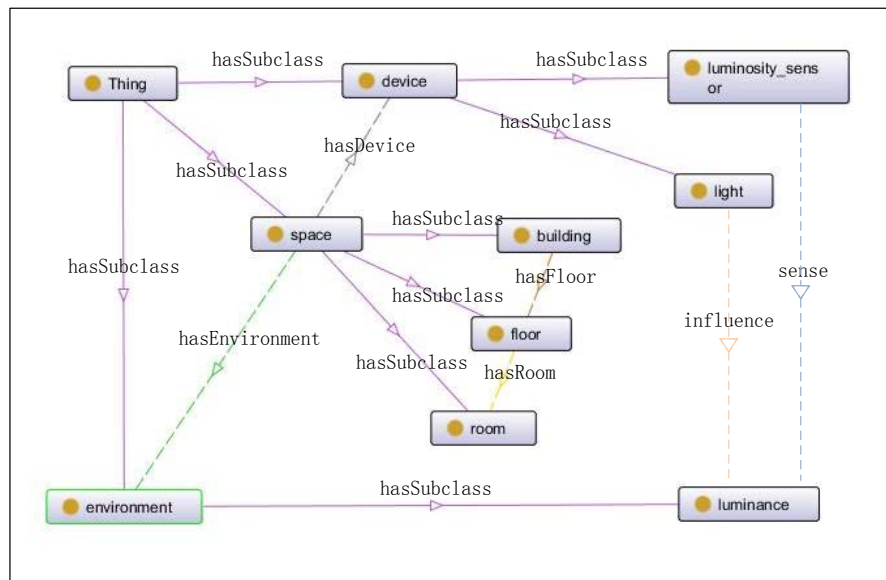

Figure A.21: Class Concepts in ontology A

The class concepts in ontology A for this use case are described in Figure A.21, and the data properties model for class “light” and class “luminosity_sensor” in ontology A are described in Figure A.22. The class concepts in ontology B for this use case are described in Figure A.23. Some basic concepts in ontology B are referred from ontology A. The “brightness_adjustable_light” in ontology B is defined as the “light” which “brightness_adjustable” data property is “true”, i.e. the domain of class “brightness_adjustable_light” is intersection of the domain of class “light” and the domain of the class where “brightness_adjustable” data property is “true”, which is shown in Figure A.24. Similarly, the “led_light” and “fluorescent_light” in ontology B are defined as the “light” which “kind” are “led” and “fluorescent” respectively.

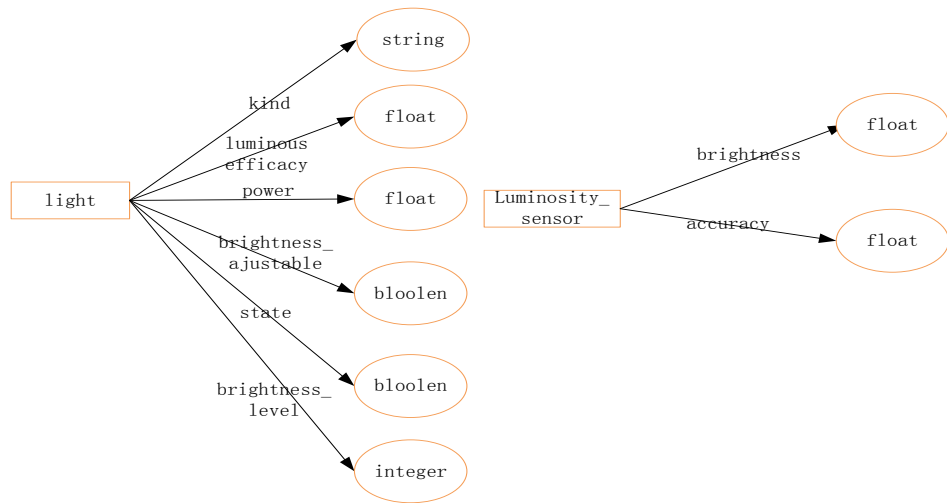

Figure A.22: data properties model in ontology A

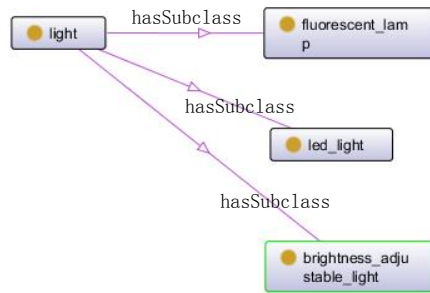

Figure A.23: Class related Concepts in ontology B

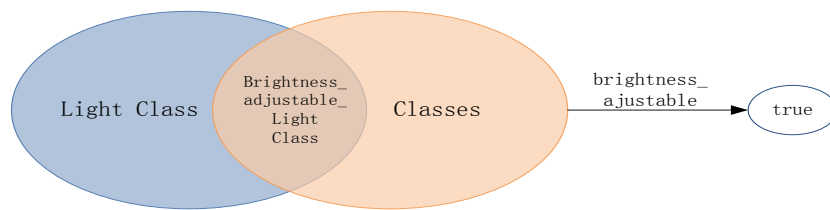

Figure A.24: intersection description for Class "brightness_adjustable_light"

Examples of instances related to this use case are described in Figure A.25, where “type” means “instance of”.

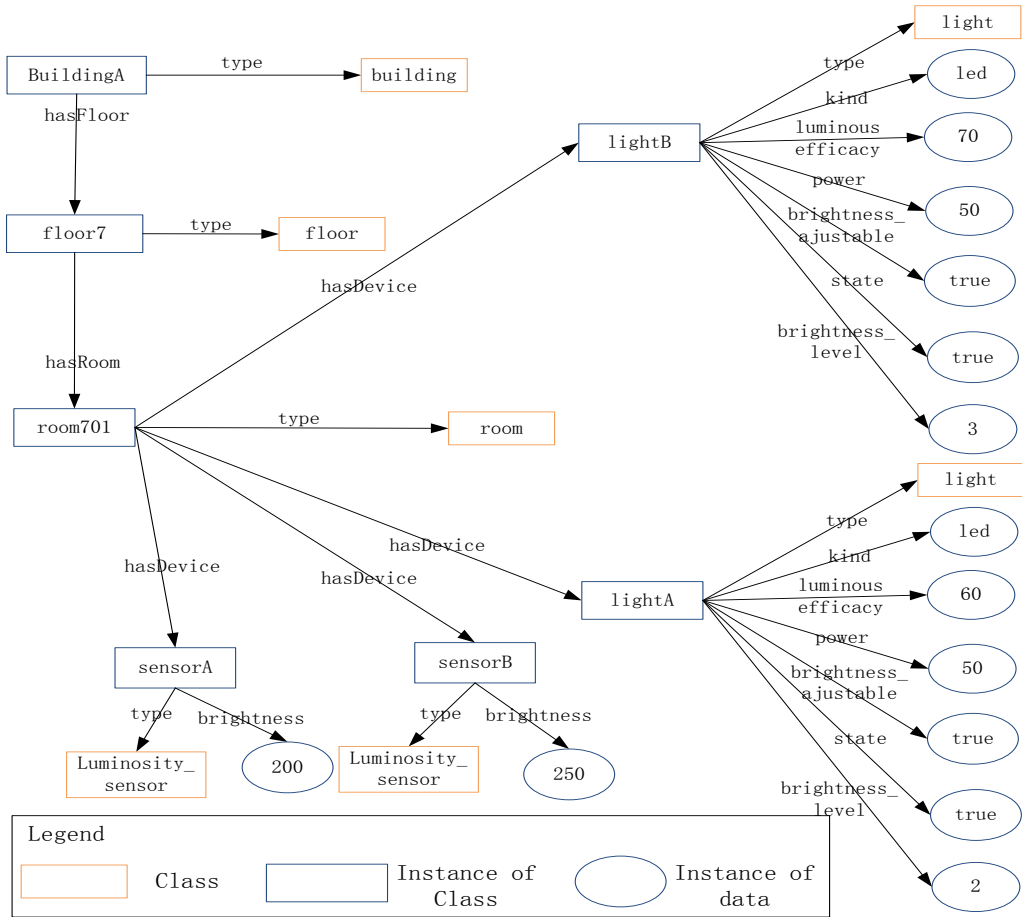

Figure A.25: Example of instances

A.6.2 Source

China Unicom

A.6.3 Actors

- Light control application (developed by application provider)
- Smart building Control centre (operated by smart building service provider)
- M2M gateway (operated by M2M service provider)
- oneM2M platform (operated by M2M service provider)
- Smart building appliances (installed by smart building service provider)

A.6.4 Pre-conditions

- The smart building service provider establishes a business relationship with the M2M service provider so that the Smart building Control centre and Smart building appliances can use M2M gateway and oneM2M platform.
- All smart building appliances are registered in oneM2M platform, and smart building control centre can control smart building appliances via oneM2M platform.
- Ontology A is referenced by all actors, and Ontology B is referenced by light control application.

A.6.5 Triggers

- Light control application intends to control the light to adjust the brightness conditions in target room (perhaps when the motion sensor in that room detects that there are people entering that room).

A.6.6 Normal Flow

- 1) Since luminosity sensors can sense the brightness conditions of rooms, light control application sends semantic request to smart building control centre to find luminosity sensors in room701.

PREFIX building: <http://example.org /ontologyA.owl#>

Select ?luminosity_sensor ?brightness

WHERE { building:room701 hasDevice ?luminosity_sensor.

?luminosity_sensor a building: luminosity_sensor.

?luminosity_sensor building:brightness ?brightness}

- 2) Smart building Control centre forwards the semantic query requests to oneM2M platform.
- 3) oneM2M platform returns the URI of target luminosity sensor resources and the associated semantic information.

Given the Search results of requested semantic query

luminosity_sensor	brightness
SensorA	200
SensorB	250

- 4) Light control application send requests to smart building control centre to create the group of the returned resources and to subscribe the brightness data of created group.
- 5) Smart building control centre forwards the group management requests and subscription requests to oneM2M platform.
- 6) The brightness data is notified to light control application.
- 7) Light control application finds that the brightness is a little lower than desired value, and intends to adjust the brightness of some lights instead of switching on more lights for power saving. The Led light is preferred, and the brightness level of led light should be lower than the highest level 5. So light control application sends semantic query request to smart building control centre to find the target brightness_adjustable light.

PREFIX building: <http://example.org/ontologyA.owl#>

PREFIX light:< http://example.org /ontologyB.owl#>

Select ?light ?brightness_level

WHERE { building:room701 hasDevice ?light.

?light a light: brightness_adjustable_light.

?light a light: led_light.

?light building:brightness_level ?brightness_level.

FILTER(?brightness_level < 5)}

- 8) Smart building Control centre forwards the semantic query requests to oneM2M platform.
- 9) Although the instances of “light” (e.g. “lightA” and “lightB”) are semantically annotated based on ontology A which do not explicitly indicate that they are instances of “brightness_adjustable light” and “led_light”, with the help of reasoning, oneM2M platform can still correctly return the URI of target light resources and the associated semantic information.

The following two ways can be adopted to support such operation.

- 1) Deriving implicit knowledge and changing the semantic annotation information of instances according to the concepts in referenced ontologies

For example, the reasoning function can derive that lightA and lightB are instances of brightness_adjustable light and led_light, and can change the semantic annotation information of lightA and lightB as

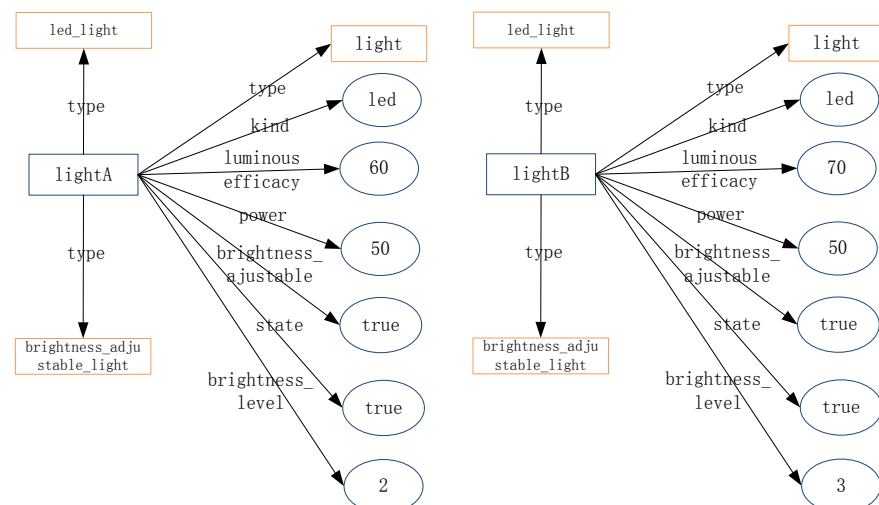

Figure A.26: examples of changed semantic annotation of instances

After changing the semantic annotation information, using the original semantic request can correctly find the target resources.

- 2) Changing the semantic query request according to the concepts in referenced ontologies. For example, according to the knowledges in ontology B, the reasoning function can change the semantic request as

PREFIX building: <http://example.org/ontologyA.owl#>

PREFIX light:< http://example.org /ontologyB.owl#>

PREFIX xsd: <http://www.w3.org/2001/XMLSchema#>

Select ?light ?brightness_level

WHERE {{ building:room701 hasDevice ?light.

?light a light: brightness_adjustable_light.

?light a light: led_light.

?light building:brightness_level ?brightness_level.

FILTER(?brightness_level < 5)}

UNION

{ building:room701 hasDevice ?light.

?light a building: light.

?light building:brightness_level ?brightness_level.

?light building:brightness_adjustable ?brightness_adjustable.

?light building:kind ?kind.

FILTER(?brightness_level < 5 && regex(?kind,"led") && ?brightness_adjustable = "true"^^xsd:boolean}}

Using the changed semantic query request can correctly find the target resources.

Given the Search results of requested semantic query

light	brightness_level
lightA	2
lightB	3

- 10) Light control application sends requests to smart building control centre to create the group of the returned resources.
- 11) Smart building control centre forwards the group management requests to oneM2M platform.
- 12) The Light control application sends the requests to adjust the brightness level of created light group.

A.6.7 Post-conditions

none

A.6.8 High Level Illustration

Figure A.27 describes the deployment of all actors in this use case from high level aspects. The smart building appliances are connected with M2M gateways, and M2M gateways are connected with oneM2M platform via underlying network. The Smart building control centre is connected with oneM2M platform, and the light control applications are connected with smart building control centre.

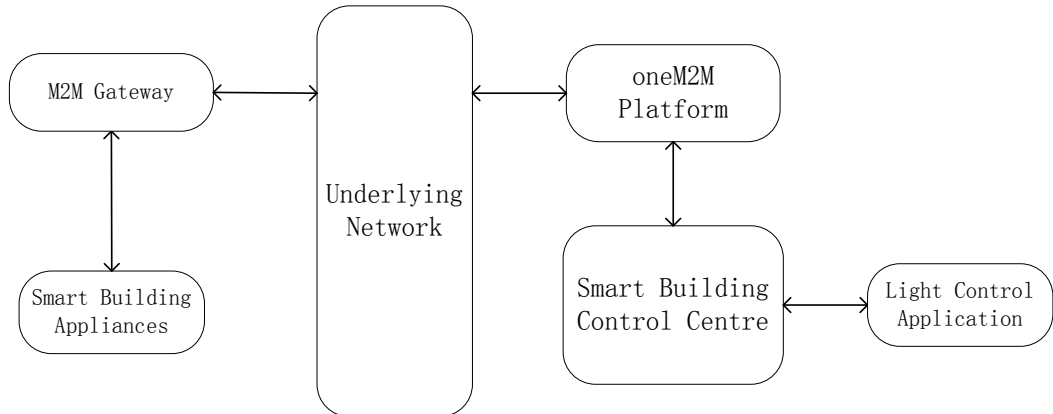

Figure A.27: connection relationships of actors

A.6.9 Potential requirements

- The oneM2M systems shall support the reasoning capability for deriving implicit knowledge from semantically annotated information according to referenced ontologies.

A.7 Smart Home load control use case

A.7.1 Description

This use case is a key constituent of home energy management. Fine-grain control of all electrical appliances, be they connected to a communication network or not, makes it possible for the home to be fully integrated in a smart grid, where supply does not merely follow variations of aggregate loads, but a two-way mutual adaptation is possible to support a much better overall efficiency and a better matching of available energy resources to the needs of consumers.

Two variants of this use case are, respectively, power-based or energy-based load shedding.

In power-based load shedding, a threshold on aggregate power may vary on different time-scales and requires instant adaptation by either shedding (turning off) or deferring loads. This corresponds to the case where the home is connected to a regular distribution grid where demand management is dictated by the distribution system operator.

In energy-based load control, the home operates on a limited energy budget for a given time span (e.g. 24 hours) and loads may be shed or shifted to stay within these limits. This corresponds to the case where the home is part of a microgrid that sets a priority on the use of limited local energy resources, with recourse to the external distribution grid used only as a last resort.

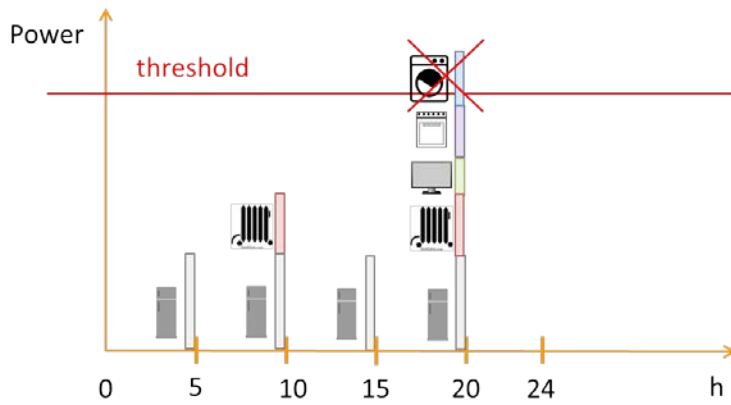

Figure A.28:

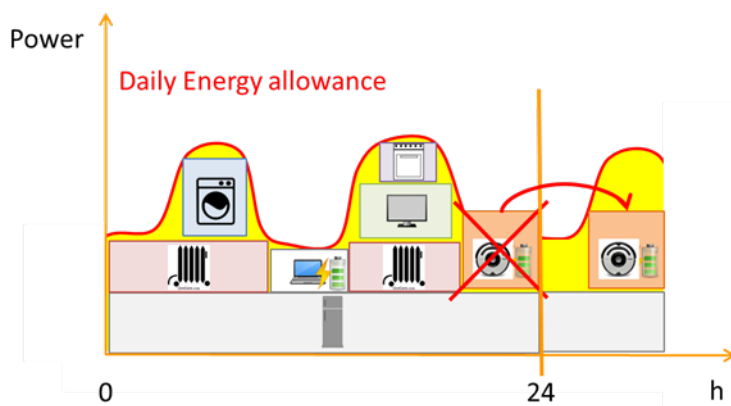

Figure A.29:

A.7.2 Source

Orange Labs (ETSI)

A.7.3 Actors

- Energy distribution operator or microgrid management system
- Home energy management system
- Individual home appliances that can be controlled either directly or indirectly
- Home M2M platform
- Home users

- Home context

A.7.4 Pre-conditions

A.7.5 Triggers

- Change of power threshold set for home electricity consumption by energy distribution operator (for power-based variant)
- Turn on appliance that leads to exceed set aggregate power threshold
- Change of energy budget for target time-span (for energy variant) : this may be due to e.g. better than predicted solar generation from PV panel
- Deviation from predict use that leads to significantly deviate from allocated resources.

A.7.6 Normal Flow

9. In both variants of this use case, appliances whose use can be deferred are deferred in order of decreasing priority, then appliances that can be turned off are shed in order of decreasing priority, according to the category they belong to : comfort, entertainment, non-critical assistance, security, safety & critical assistance (the latter category shall in principle never be turned off), until the constraints are met. Closed loop control can be applied iteratively to individual appliances.
10. In case the power threshold or energy budget increases, a similar iterative procedure can be applied in reverse order by turning on appliances whose use might have been previously deferred.

A.7.7 Post-conditions

- Aggregate power returned under threshold
- Aggregate energy within budget in target time span

A.7.8 High Level Illustration

See figures A.28 and A.29.

A.7.9 Potential requirements

- The M2M System shall provide the capability for entities of the M2M system (e.g. AEs, or CSEs) to publish semantic descriptions within the M2M system.
- The M2M System shall support parsing and interpreting semantic descriptions.
- The M2M System shall support resource discovery based on semantics.

<PAGE BREAK>

Annex : Title of annex (*style H9*)

<Text>

B.1 First clause of the annex (*style H1*)

<Text>

B.1.1 First subdivided clause of the annex (*style H2*)

<Text>

<PAGE BREAK>

Annex <y>: Bibliography

The annex entitled "Bibliography" is optional.

It shall contain a list of standards, books, articles, or other sources on a particular subject which are not mentioned in the document itself.

It shall not include references mentioned in the document.

*Use the **Heading 9 style** for the title and B1+ or Normal for the text.*

- <Publication>: "<Title>".

OR

<Publication>: "<Title>".

<PAGE BREAK>

History

This clause shall be the last one in the document and list the main phases (all additional information will be removed at the publication stage).

Publication history		

Draft history (to be removed on publication)		
V.0.0.1	22 03 2013	Skeleton
V.0.1.0	18.04.2013	Approved at MAS #4
V.0.2.0	07.05.2013	Incorporate agreed contributions from MAS #4 - oneM2M-MAS-2013-0021R01-ETSI_style_device_abstraction - oneM2M-MAS-2013-0022R01-ETSI_style_semantic_m2m
V.0.3.0	28.06.2013	Incorporate agreed contributions from MAS at TP#5 (Seoul) - oneM2M-MAS-2013-0047R02-Home_Environment_Monitoring_Service_using_semantic_mash-up
V.0.4.0	15.08.2013	Incorporate agreed contributions from MAS6.0 at TP6 (Toronto) - oneM2M-MAS-2013-0069R01-oneM2M_Architectural_Considerations_for_Semantics - oneM2M-MAS-2013-0075R01-A_device_abstraction_technology_in_Home_Gateway - oneM2M-MAS-2013-0081R01-Input_to_TR0007
V.0.5.0	18.10.2013	Incorporate agreed contributions from MAS #7.0 at TP#7 (Sophia-Antipolis) - oneM2M-MAS-2013-0106-OGC_standards - oneM2M-MAS-2013-0107-W3C_standards
V.0.6.0	13.12.2013	Incorporate agreed contributions from MAS #8.0 at TP#8 (Miyazaki) - oneM2M-MAS-2013-0131R03-Ontology_Requirements
V.0.7.0	21.02.2014	Incorporate agreed contributions from MAS #9.0 at TP#9 (Mobile) - MAS-2014-0024-Overview_on_Semantics_for_TR_0007 - MAS-2014-0025R01-Semantic_Home_Control_use_case - MAS-2014-0029R03-UseCase-Intelligent_Alarm_Service In addition errors from version 0.6.0 of the TR were corrected (oneM2M-MAS-2013-0075R01 and oneM2M-MAS-2013-0081R01 were missing).
V.0.8.0	11.04.2014	Incorporate agreed contributions from MAS #10.0 at TP#10 (Berlin) - MAS-2014-0353R01-Architectural_Considerations_for_Semantic_Support - MAS-2014-0354R02-Device+DeviceTemplate-Modelling - MAS-2014-0359R01-Key_Issues_on_Semantics_and_Ontologies - MAS-2014-0356-proper_usage_terminologies_ABS_TR
V.0.9.0	12.05.2014	Restructured according contribution from MAS #10.2 in MAS-2014-0378R01-restructuring_TR-0007- Study_on_Abstraction_and_Semantics_Enablement

V.0.10.0	16.06.2014	<p>Incorporate agreed contributions from MAS #11.0 at TP#11 (Xi' An)</p> <ul style="list-style-type: none"> - MAS-2014-0380R02-Use_Case_of_Semantic_Home_Automation - MAS-2014-0391R04-semantic_smart_building_light_control_use_case - MAS-2014-0392R01-Key_issues_on_reasoning - MAS-2014-0395R01-Section5_ABS_TR - MAS-2014-0396R02-semantics_overview_ABS_TR - MAS-2014-0397R02-semantics_requirements_ABS_TR - MAS-2014-0403R01-Overview_of_Modelling_Aspects - MAS-2014-0404R03-Modelling_of_Devices_and_Things
V 0.11.0		<p>MAS-2014-0409R01 Home Energy Management Use Case</p> <p>MAS-2014-0426R02-Key_issues_on_semantic_rule</p> <p>MAS-2014-0429R02-Using_Semantics_to_model_Interworking_with_non-oneM2M_Devices_in_Rel-1</p> <p>MAS-2014-0430R01-Proposed_conclusion_section_of_TR-0007_(Semantics)</p> <p>MAS-2014-0431R01-Resolving_some_remaining_issues_with_TR-0007_(Semantics)</p> <p>MAS-2014-0437-subclasses_of_parameter_for_device_template_modelling_using_ontologies</p> <p>MAS-2014-0442R01-Semantic_functionalities_update_TR0007</p> <p>MAS-2014-0443R01-UseCases_ABS_TR</p> <p>MAS-2014-0448-Modelling_of_Associations</p>